



US00D888545S

(12) **United States Design Patent**
Dissing

(10) **Patent No.:** **US D888,545 S**

(45) **Date of Patent:** **** Jun. 30, 2020**

(54) **SCREW HEAD**

(71) Applicant: **Dissing A/S**, Skanderborg (DK)

(72) Inventor: **Claus Hornstrup Dissing**, Ry (DK)

(**) Term: **15 Years**

(21) Appl. No.: **35/506,644**

(22) Filed: **Dec. 19, 2018**

(80) **Hague Agreement Data**

Int. Filing Date: **Dec. 19, 2018**

Int. Reg. No.: **DM/200585**

Int. Reg. Date: **Dec. 19, 2018**

Int. Reg. Pub. Date: **Apr. 19, 2019**

(51) **LOC (12) Cl.** **08-08**

(52) **U.S. Cl.**

USPC **D8/387**

(58) **Field of Classification Search**

USPC D8/387, 382, 385, 388, 391, 393

CPC F16B 23/003; F16B 23/0038; F16B

23/0046; F16B 25/0036; F16B 25/0052;

F16B 25/0057; F16B 25/0063; F16B

25/0068; F16B 25/0078; F16B 25/0084

See application file for complete search history.

(56) **References Cited**

U.S. PATENT DOCUMENTS

D416,475 S * 11/1999 DePrisco D8/387

D567,643 S * 4/2008 Campbell D8/387

D567,644 S * 4/2008 Liu D8/387

D581,776 S * 12/2008 Yin-Feng D8/387

D818,355 S * 5/2018 Sears D8/387

D829,088 S * 9/2018 Campbell, II D8/387

D840,796 S * 2/2019 Hsiao D8/387

D847,622 S * 5/2019 Taylor D8/387

D853,830 S * 7/2019 Wang D8/387

D874,251 S * 2/2020 Neuhofer, Jr. D8/387

* cited by examiner

Primary Examiner — Melanie H Tung

Assistant Examiner — Bao-Yen T Nguyen

(57) **CLAIM**

The ornamental design for a screw head, as shown and described.

DESCRIPTION

1. Screw head

1.1: Left side perspective view;

1.2: Right side perspective view;

1.3: Bottom perspective view;

1.4: Left side view;

1.5: Bottom view

1.6: Top view;

1.7: Front view.

The dotted lines represent portions of the screw head and form no part of the claimed design.

1 Claim, 7 Drawing Sheets

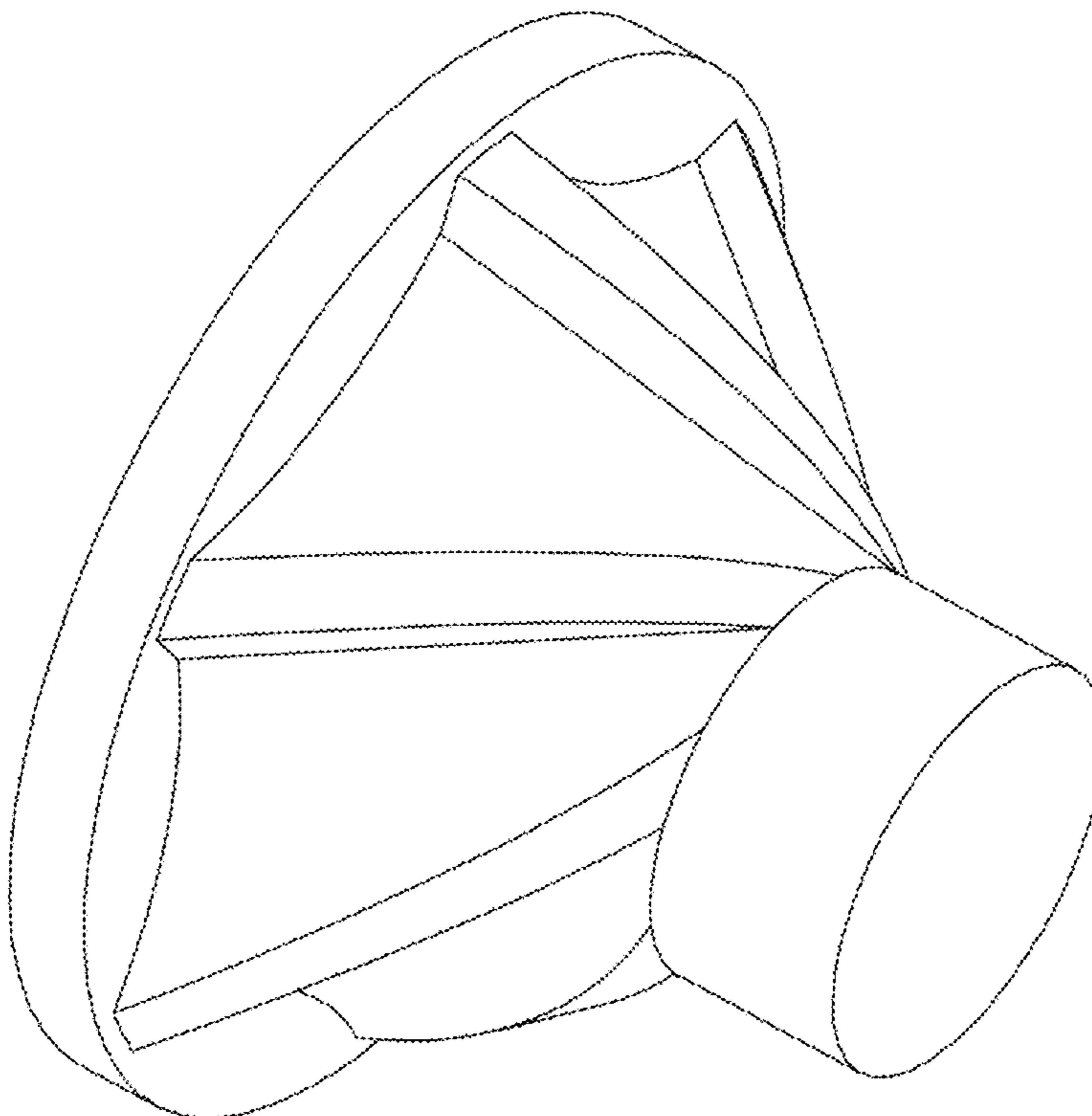

1.1

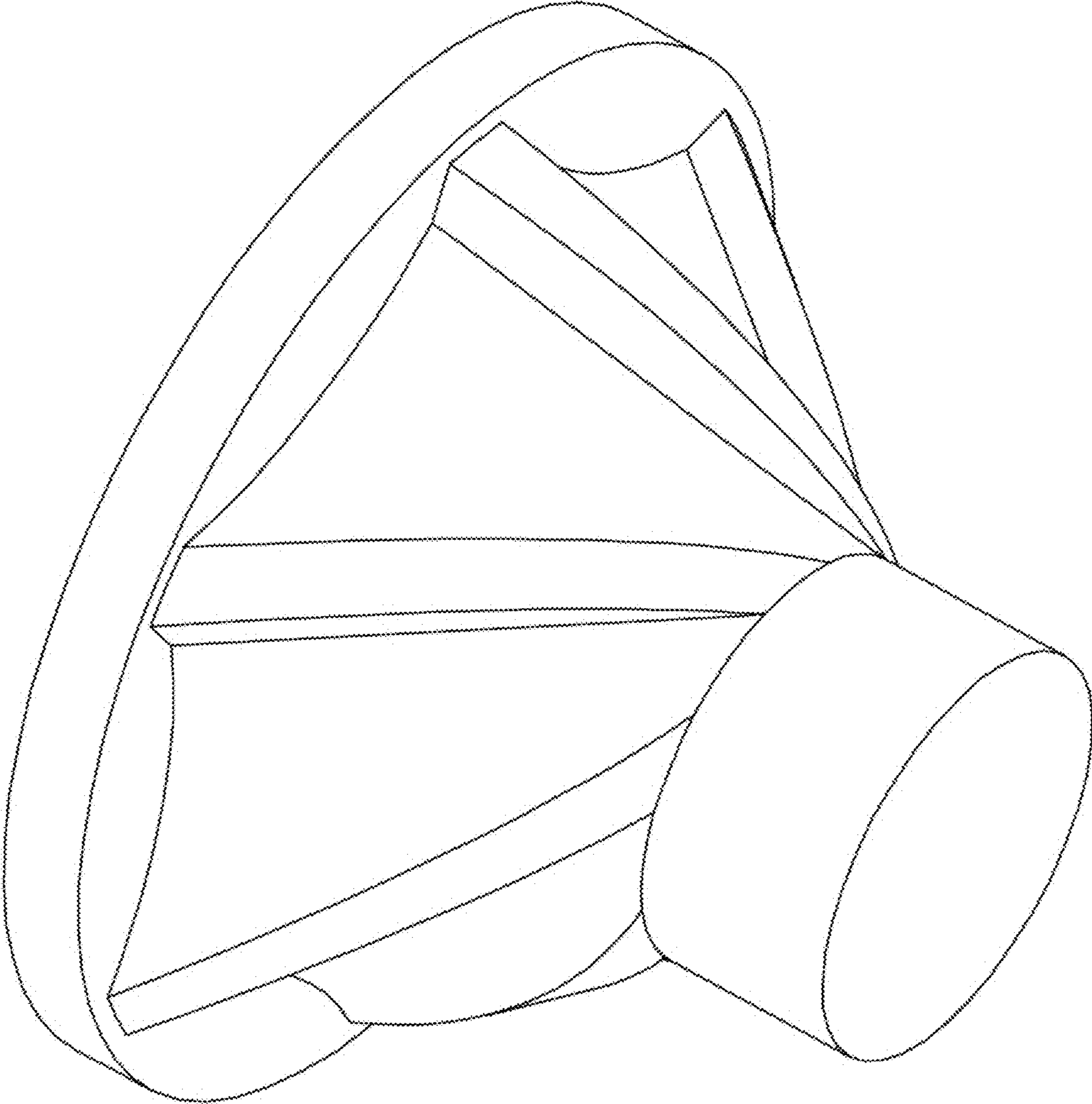

1.2

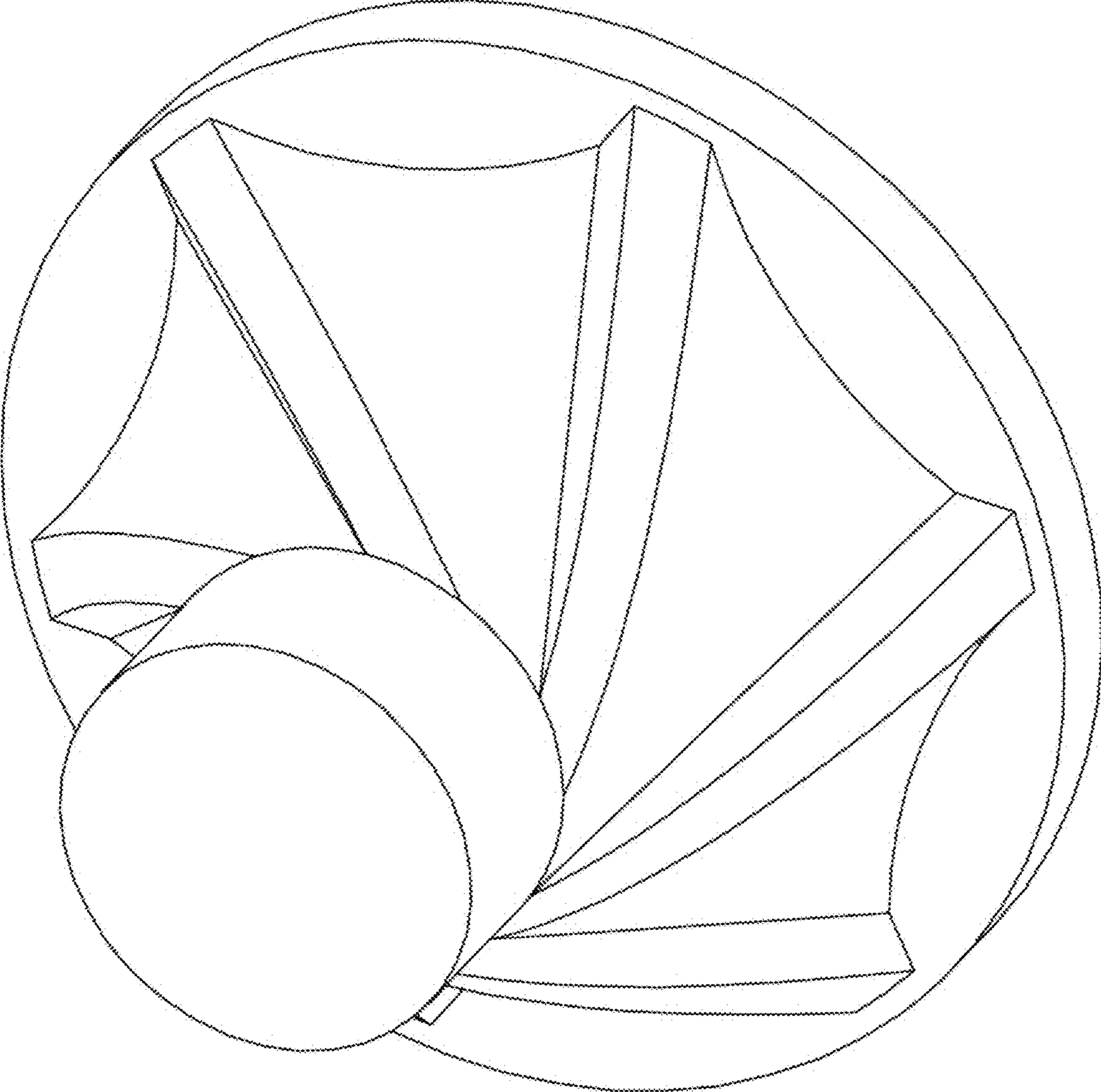

1.3

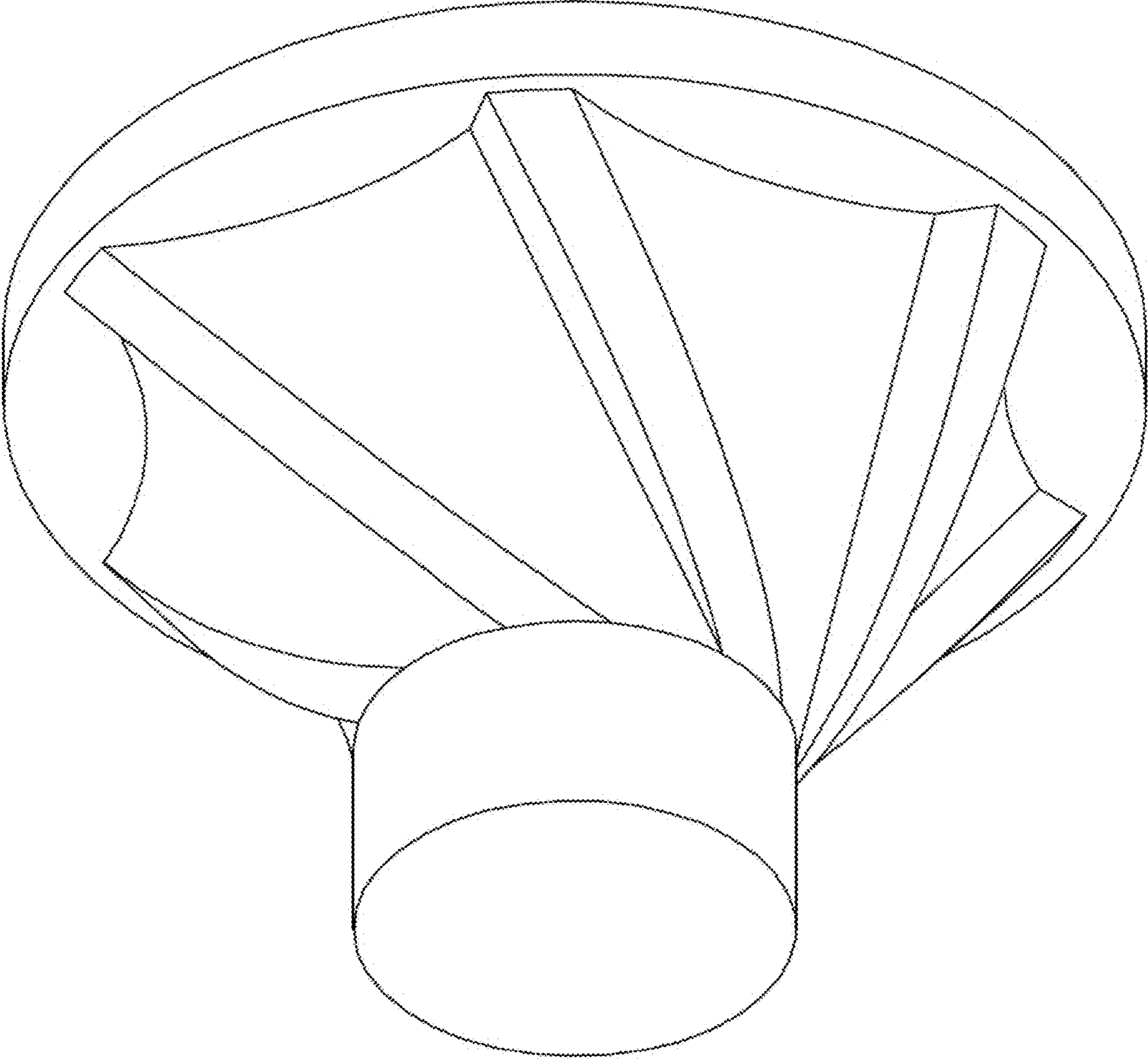

1.4

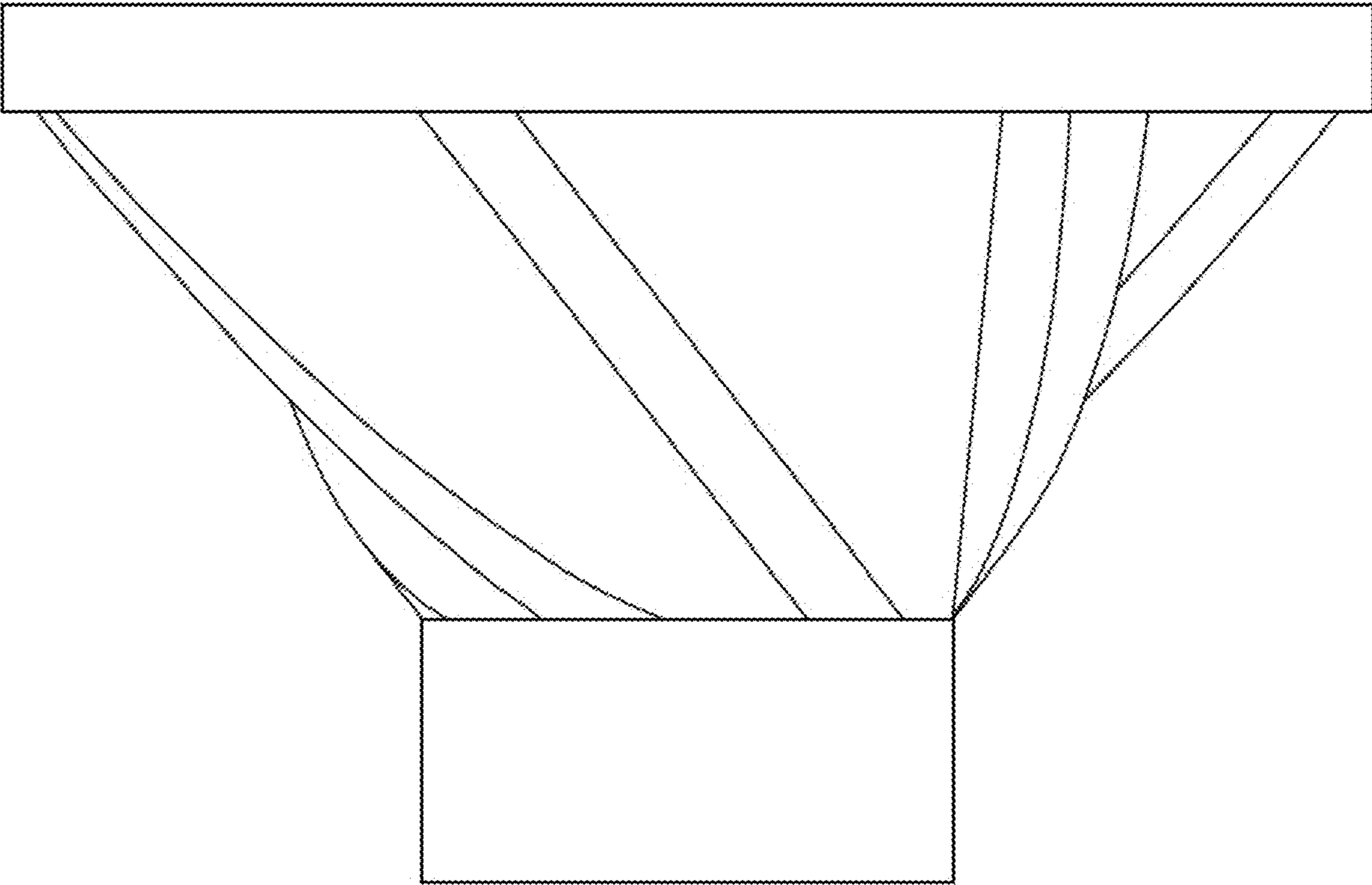

1.5

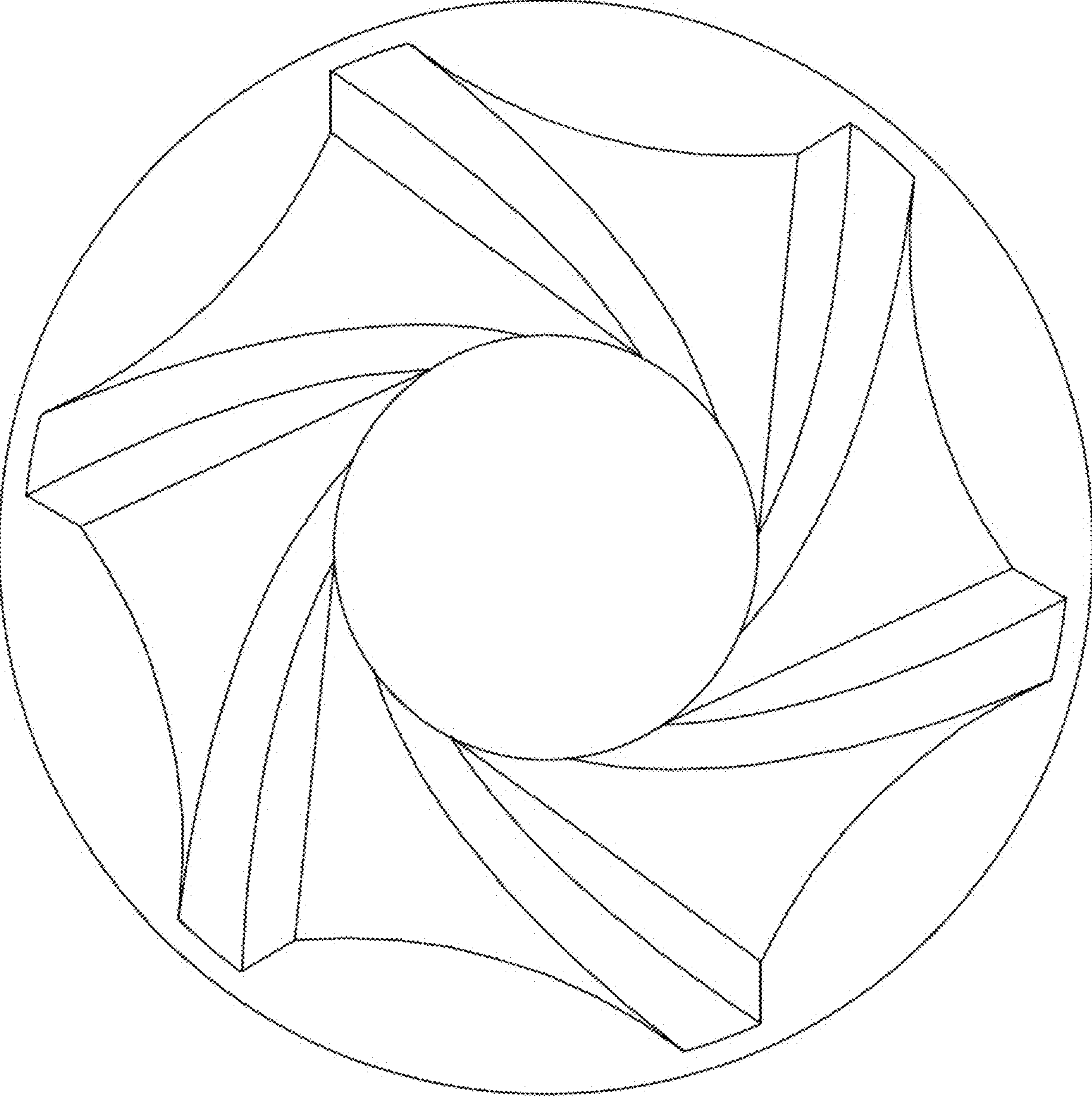

1.6

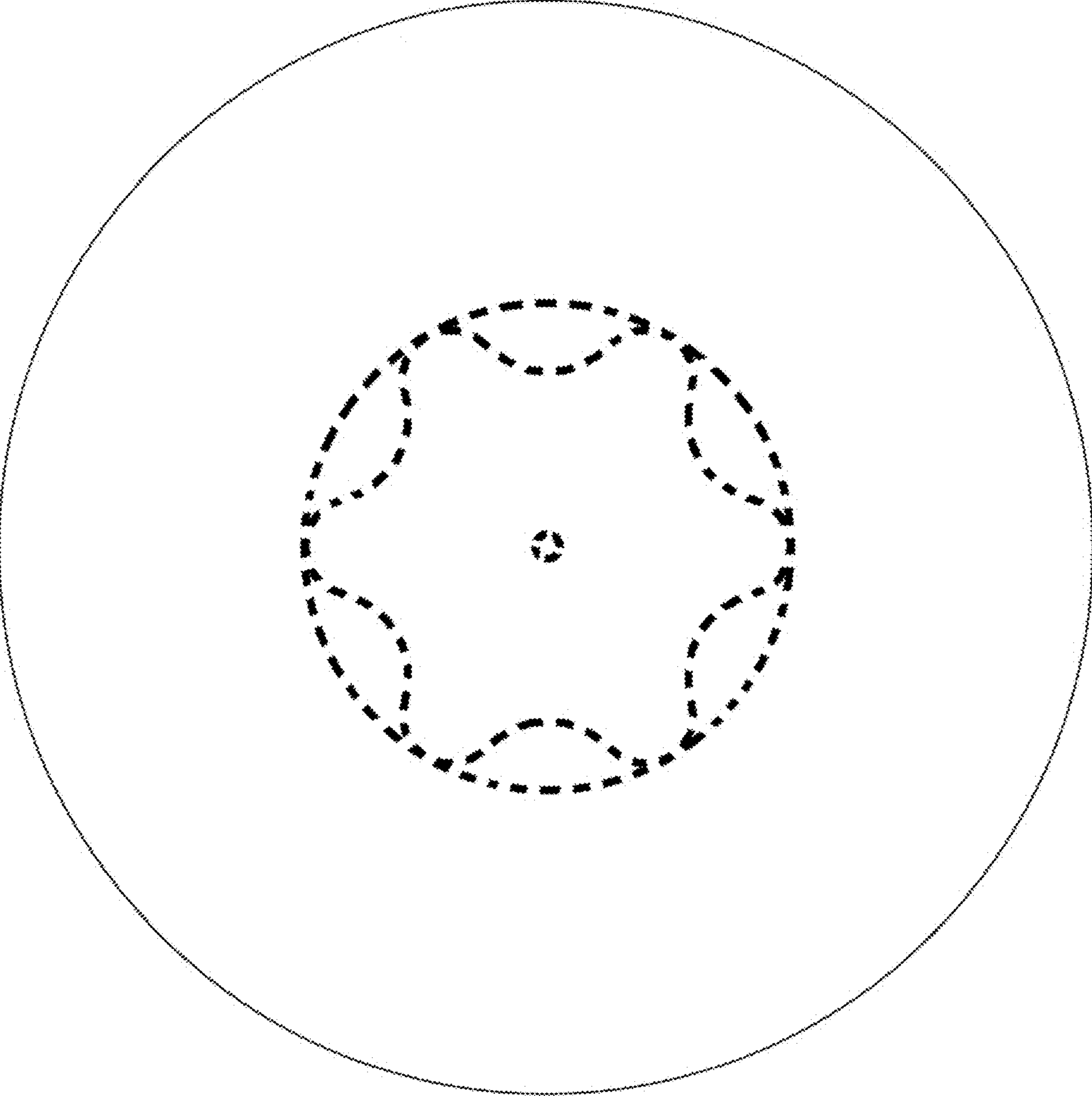

1.7

