



US00D888536S

(12) **United States Design Patent**  
**Boomer et al.**

(10) **Patent No.:** **US D888,536 S**  
(45) **Date of Patent:** **\*\* Jun. 30, 2020**

- (54) **COMPACT ELECTRONIC LOCK**
- (71) Applicant: **Schlage Lock Company LLC**, Carmel, IN (US)
- (72) Inventors: **Zachary P. Boomer**, Carmel, IN (US); **Parth Kashikar**, Boise, ID (US)
- (73) Assignee: **Schlage Lock Company LLC**, Carmel, IN (US)

(\*\*) Term: **15 Years**  
(21) Appl. No.: **29/675,791**

- (22) Filed: **Jan. 4, 2019**
- (51) **LOC (12) Cl.** ..... **08-07**
- (52) **U.S. Cl.**  
USPC ..... **D8/331**
- (58) **Field of Classification Search**  
USPC ..... D8/330, 331, 336, 338, 339, 341, 342, D8/343, 344, 346, 350, 352, 353  
CPC ... E05B 9/00; E05B 9/002; E05B 9/02; E05B 9/08; E05B 43/00; E05B 45/00; E05B 45/06; E05B 47/00; E05B 55/00; E05B 63/00; Y10T 70/5155; Y10T 70/5199;  
(Continued)

- (56) **References Cited**  
U.S. PATENT DOCUMENTS  
D393,793 S \* 4/1998 Blanch ..... D8/341  
D396,628 S \* 8/1998 Blanch ..... D8/341  
D471,786 S \* 3/2003 Ellis ..... D8/350  
(Continued)

**OTHER PUBLICATIONS**  
Best smart locks for your Siri, Alexa or Z-Wave-enabled smart home from August, Schlage, more., Blair Altland—Mar. 5, 2019, 9to5toys.com, <https://9to5toys.com/2019/03/05/best-smart-locks-2019/>.\*

*Primary Examiner* — Eric L Goodman  
*Assistant Examiner* — Steven J Czyz  
(74) *Attorney, Agent, or Firm* — Taft Stettinius & Hollister LLP

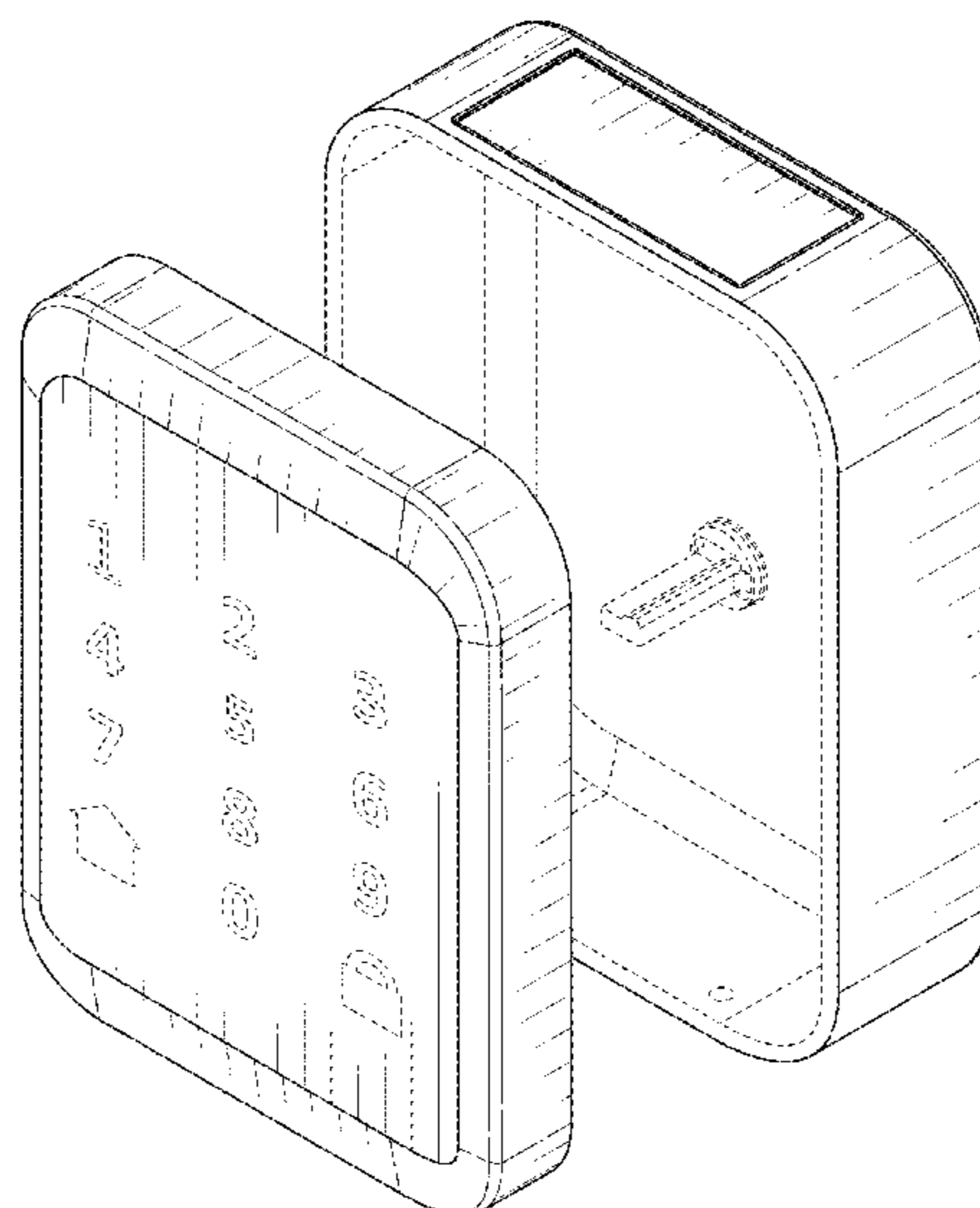
(57) **CLAIM**

The ornamental design for a compact electronic lock, as shown and described.

**DESCRIPTION**

FIG. 1 is a front, top, right side perspective view of an interior component of a compact electronic lock showing our new design;  
 FIG. 2 is a front elevational view of the interior component;  
 FIG. 3 is a right side elevational view of the interior component;  
 FIG. 4 is a left side elevational view of the interior component;  
 FIG. 5 is a top plan view of the interior component;  
 FIG. 6 is a bottom plan view of the interior component;  
 FIG. 7 is a back elevational view of the interior component;  
 FIG. 8 is a front, top, right side perspective view of an exterior component of the compact electronic lock showing our new design;  
 FIG. 9 is a front elevational view of the exterior component;  
 FIG. 10 is a left side elevational view of the exterior component;  
 FIG. 11 is a right side elevational view of the exterior component;  
 FIG. 12 is a top plan view of the exterior component;  
 FIG. 13 is a bottom plan view of the exterior component;  
 FIG. 14 is a back elevational view of the exterior component; and,  
 FIG. 15 is an exploded assembly side perspective view of the compact electronic lock showing both the interior and exterior components.  
 The broken lines in the drawing figures depict unclaimed subject matter that forms no part of the claimed design.

**1 Claim, 11 Drawing Sheets**



(58) **Field of Classification Search**  
 CPC ..... Y10T 70/5221; Y10T 70/5212; Y10T  
 70/7062  
 See application file for complete search history.

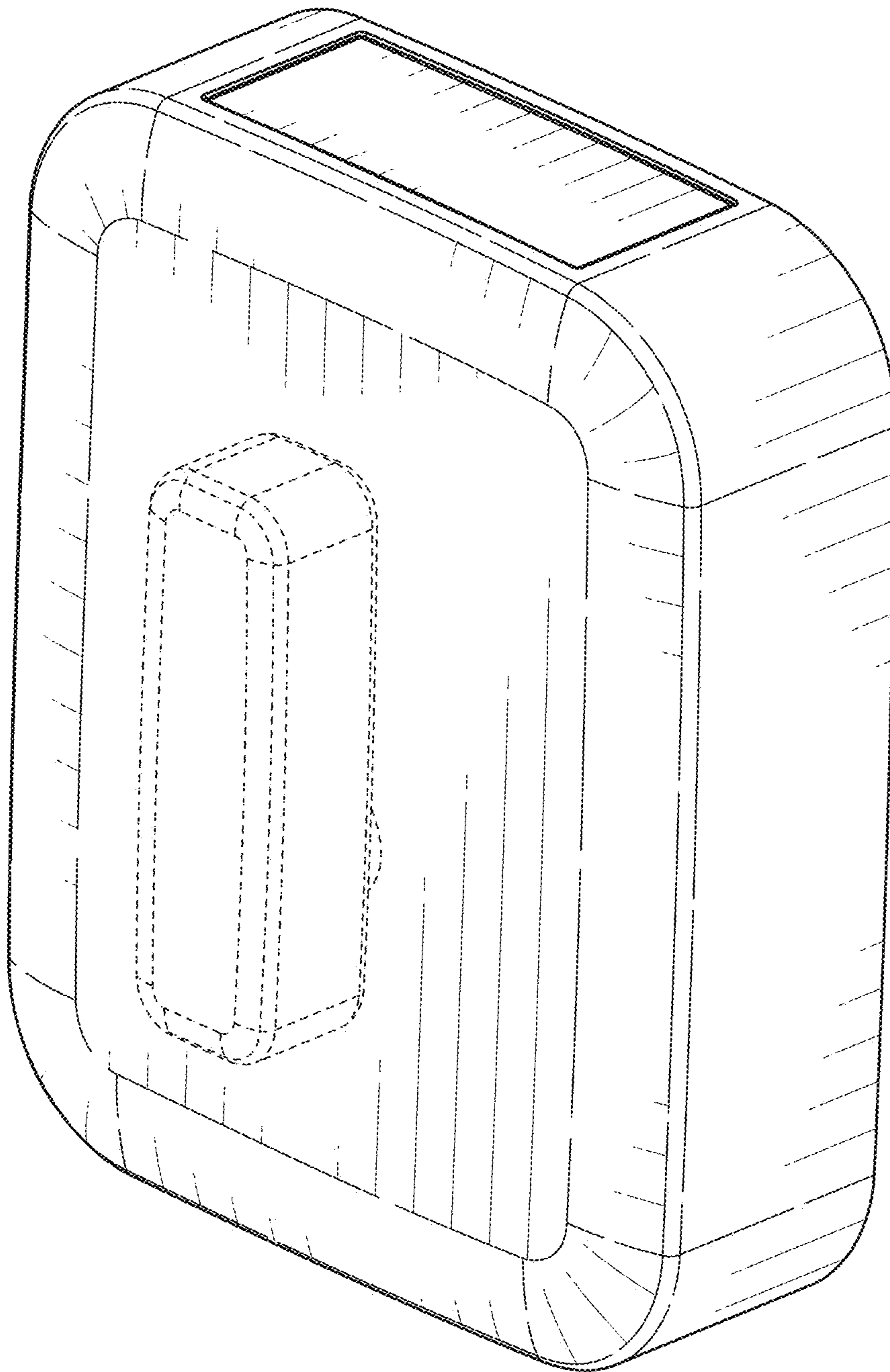
(56) **References Cited**

U.S. PATENT DOCUMENTS

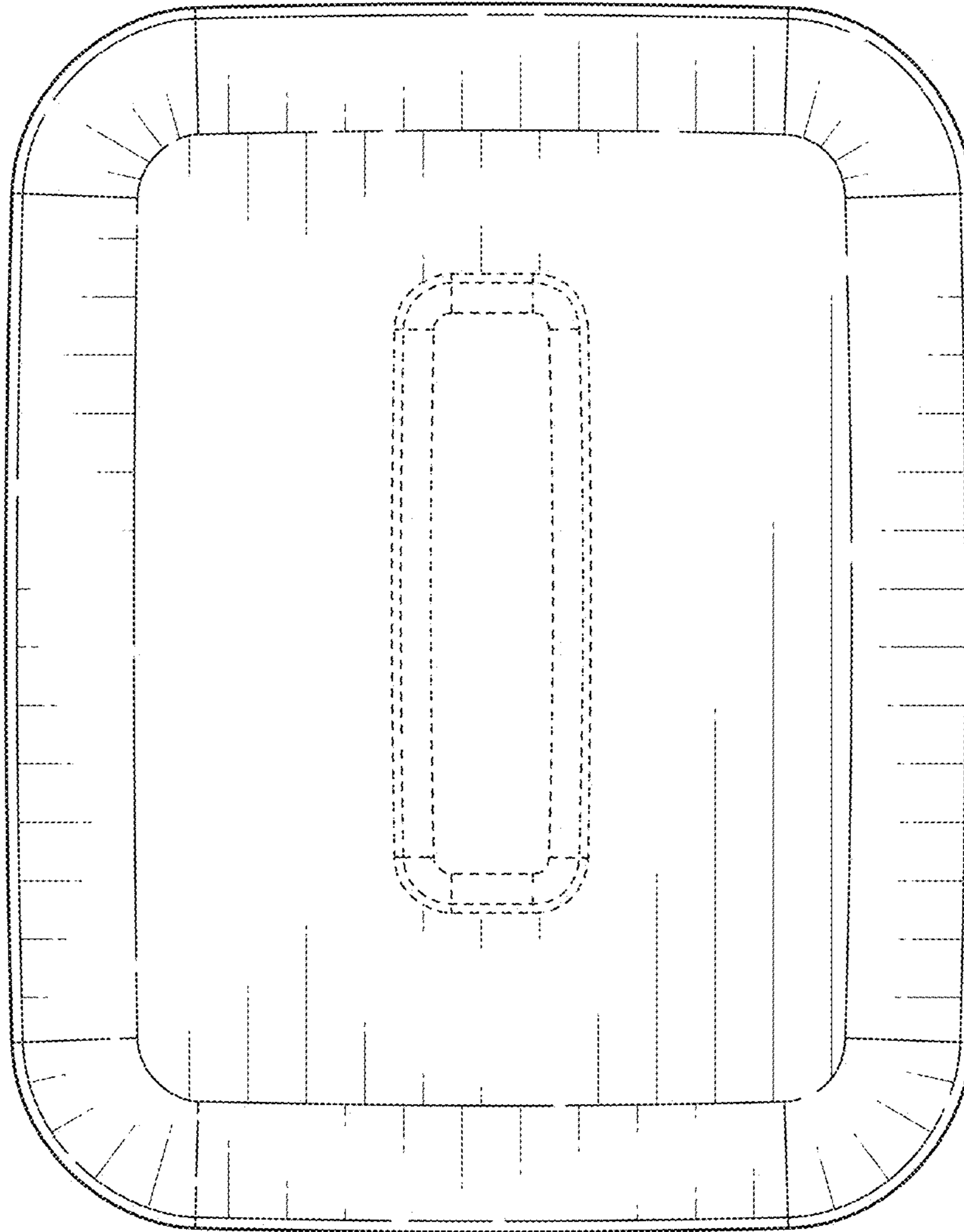
6,564,600 B1 \* 5/2003 Davis ..... E05B 47/0669  
 70/277  
 6,612,141 B2 \* 9/2003 Bates ..... E05B 47/0607  
 70/257  
 D592,936 S \* 5/2009 Douglas ..... D8/330  
 D593,399 S \* 6/2009 Douglas ..... D8/330  
 7,543,469 B1 \* 6/2009 Tseng ..... E05B 47/026  
 292/142  
 D645,726 S \* 9/2011 Lu ..... D8/330  
 D666,074 S \* 8/2012 Genord ..... D8/330  
 D677,145 S \* 3/2013 Hsieh ..... D8/330  
 D682,658 S \* 5/2013 Cramer ..... D8/331  
 D683,205 S \* 5/2013 Cramer ..... D8/331  
 8,869,574 B2 \* 10/2014 Schmidt-Lackner .....  
 E05B 17/147  
 292/244  
 D720,202 S \* 12/2014 Gokcebay ..... D8/331  
 8,931,315 B2 \* 1/2015 Frolov ..... G07C 9/00174  
 70/279.1  
 D722,260 S \* 2/2015 Warmenhoven ..... D8/330  
 D736,590 S \* 8/2015 Roberts, III ..... D8/330  
 D736,591 S \* 8/2015 Groleski ..... D8/330  
 9,097,037 B2 \* 8/2015 McKibben ..... G08C 17/02  
 D738,192 S \* 9/2015 Hetfield ..... D8/350  
 D756,749 S \* 5/2016 Lu ..... D8/331  
 D760,062 S \* 6/2016 Groleski ..... D8/331  
 D761,079 S \* 7/2016 Groleski ..... D8/331

9,406,181 B2 \* 8/2016 Almomani ..... G07C 9/00309  
 D768,463 S \* 10/2016 Kraus ..... D8/330  
 D778,708 S \* 2/2017 Jeng ..... D8/330  
 D779,305 S \* 2/2017 Ku ..... D8/330  
 D779,919 S \* 2/2017 Shargh ..... D8/330  
 D781,130 S \* 3/2017 Shargh ..... D8/330  
 D783,384 S \* 4/2017 Shargh ..... D8/330  
 D790,948 S \* 7/2017 Lai ..... D8/330  
 D790,950 S \* 7/2017 Kraus ..... D8/330  
 D792,191 S \* 7/2017 Ku ..... D8/330  
 D792,192 S \* 7/2017 Huang ..... D8/331  
 D794,414 S \* 8/2017 Chou ..... D8/330  
 D802,396 S \* 11/2017 Hsu ..... D8/330  
 D803,027 S \* 11/2017 Huang ..... D8/331  
 D811,850 S \* 3/2018 Schneider ..... D8/331  
 D812,448 S \* 3/2018 Schneider ..... D8/331  
 D817,148 S \* 5/2018 Carpintero ..... D8/331  
 D818,345 S \* 5/2018 Morstatt ..... D8/330  
 D818,795 S \* 5/2018 Morstatt ..... D8/331  
 D818,797 S \* 5/2018 Morstatt ..... D8/334  
 D826,690 S \* 8/2018 Chiang ..... D8/331  
 D833,255 S \* 11/2018 Lee ..... D8/331  
 D835,968 S \* 12/2018 Gokcebay ..... D8/331  
 D835,970 S \* 12/2018 Morstatt ..... D8/331  
 D836,417 S \* 12/2018 Gokcebay ..... D8/331  
 D837,029 S \* 1/2019 Cavanna ..... D8/331  
 10,240,365 B2 \* 3/2019 Almomani ..... G07C 9/00309  
 D844,414 S \* 4/2019 Leites ..... D8/353  
 D856,779 S \* 8/2019 Schneider ..... D8/330  
 D861,462 S \* 10/2019 Singtoroj ..... D8/353  
 D866,291 S \* 11/2019 Morstatt ..... D8/330  
 D867,104 S \* 11/2019 Morstatt ..... D8/330  
 D867,853 S \* 11/2019 Lin ..... D8/331  
 D869,261 S \* 12/2019 Watson ..... D8/330  
 D872,560 S \* 1/2020 Watson ..... D8/350

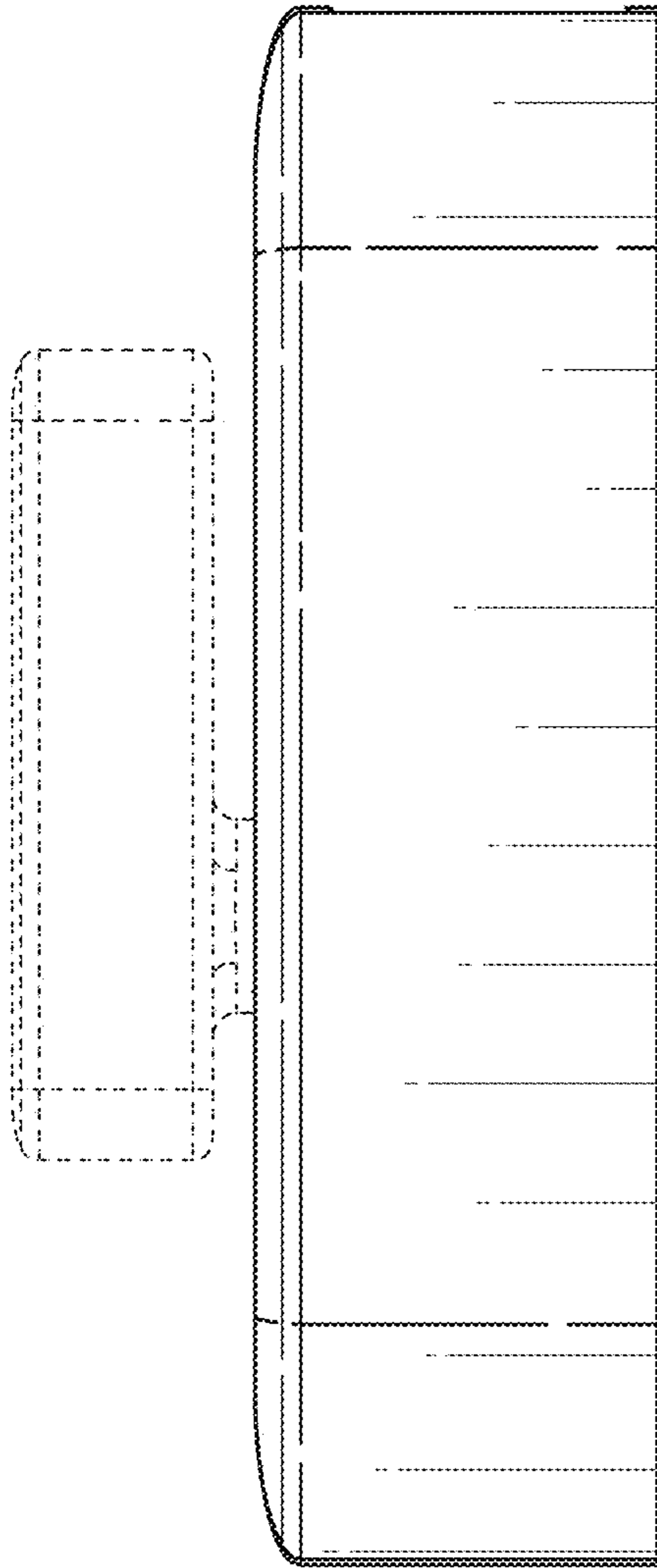
\* cited by examiner



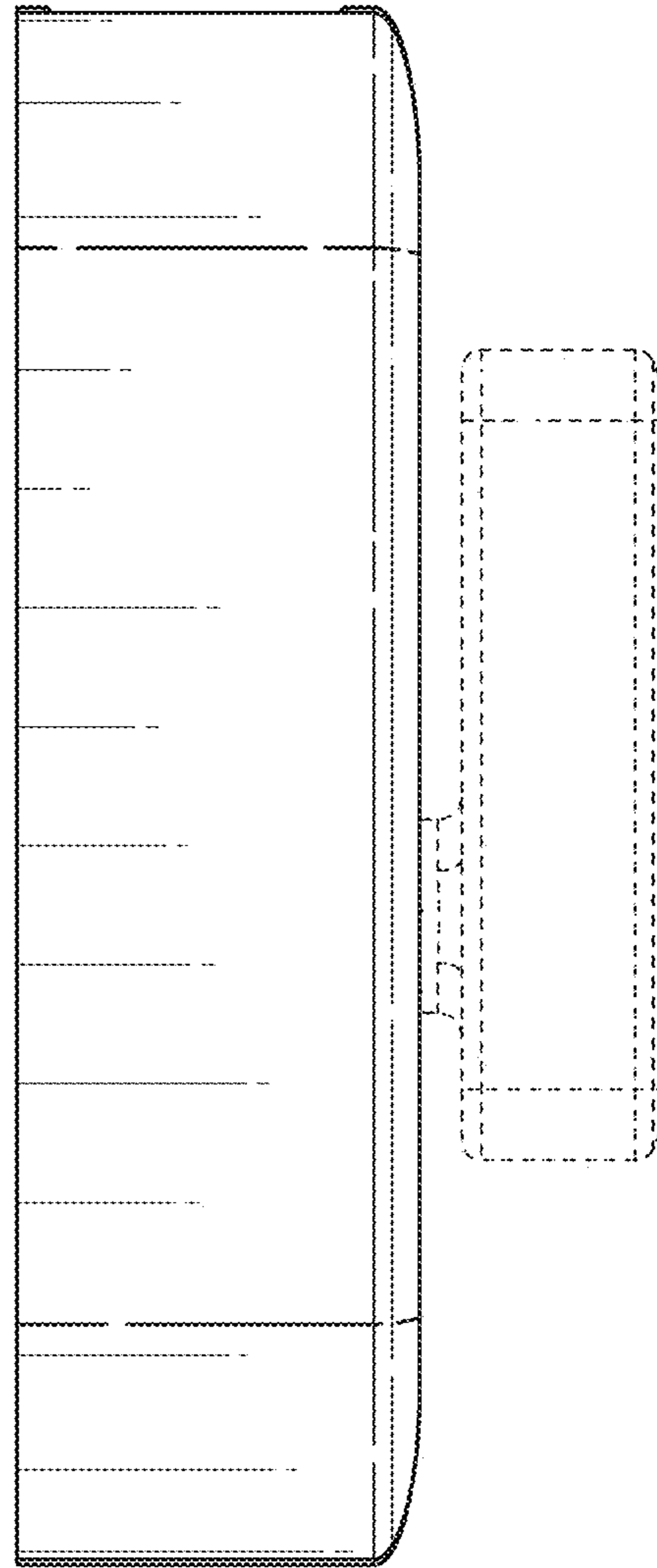
*Fig. 1*



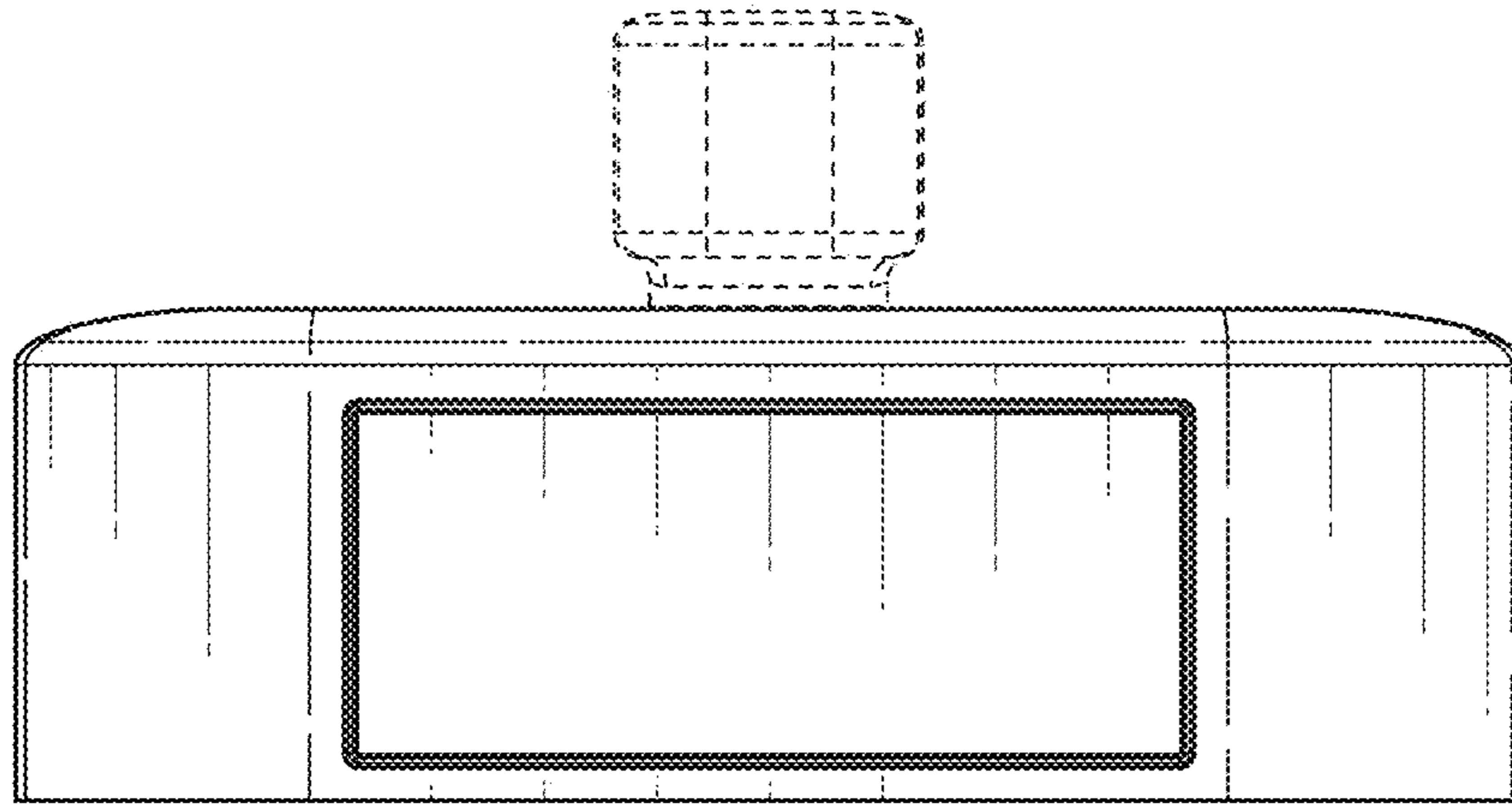
*Fig. 2*



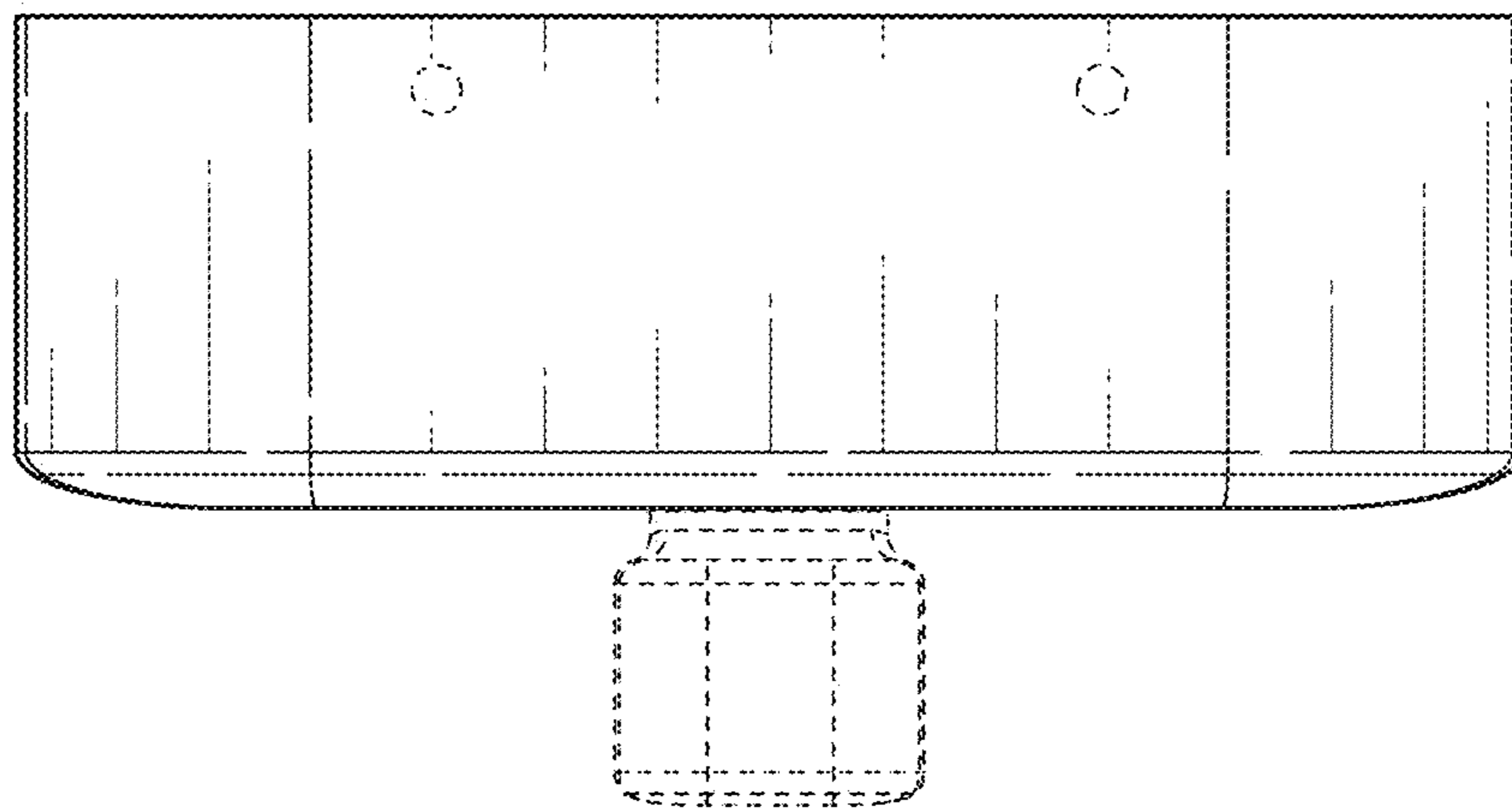
*Fig. 3*



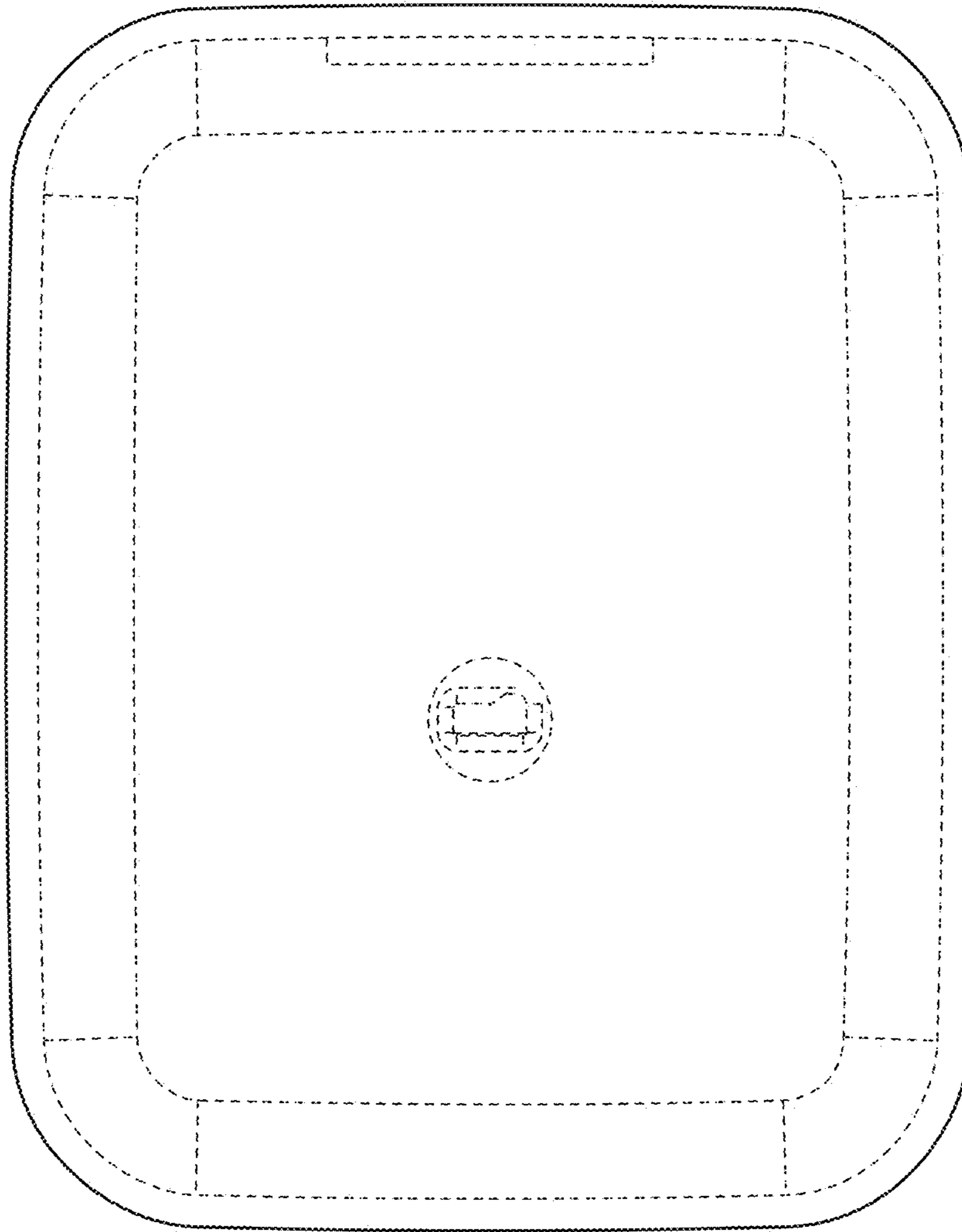
*Fig. 4*



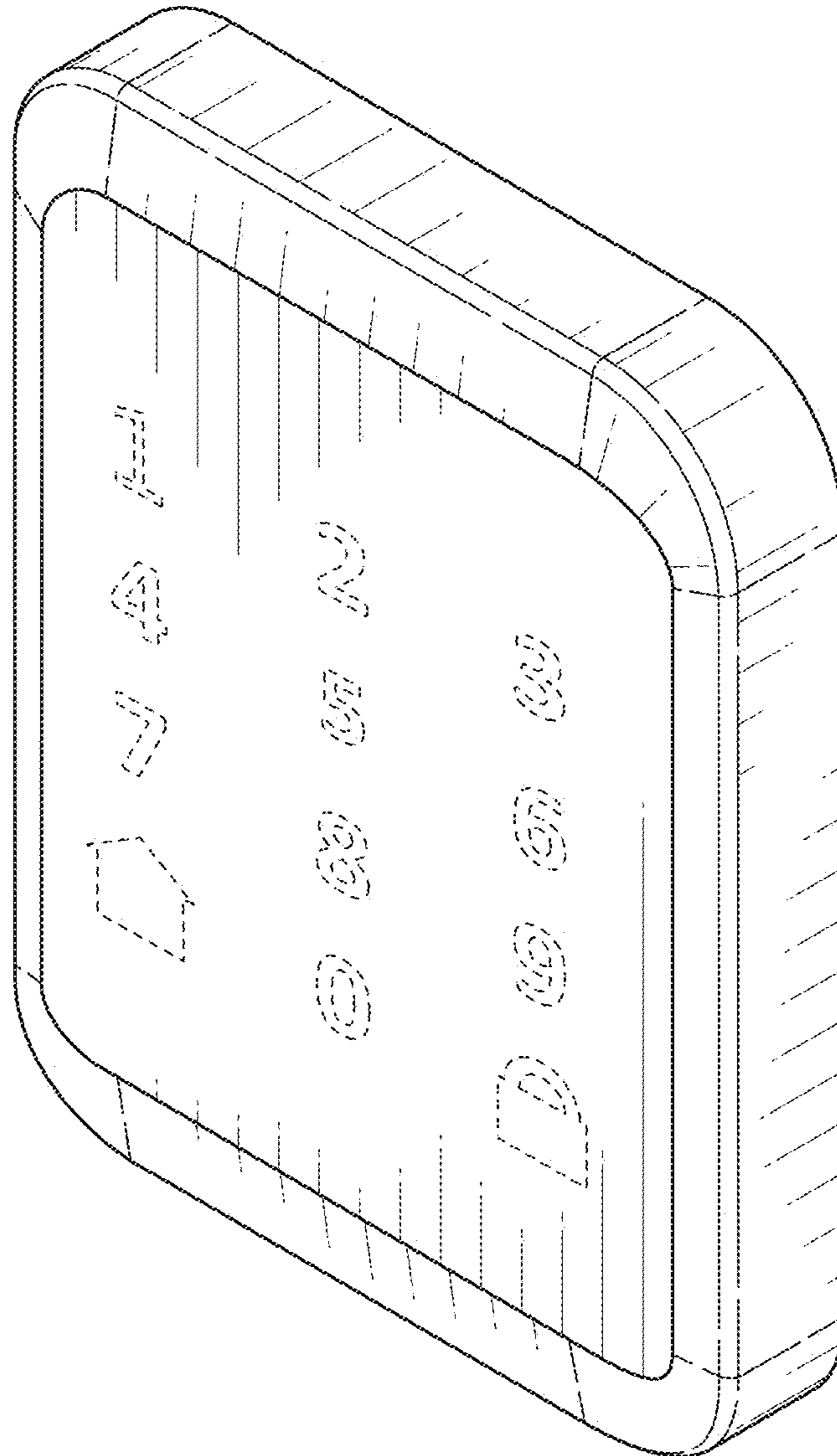
*Fig. 5*



*Fig. 6*

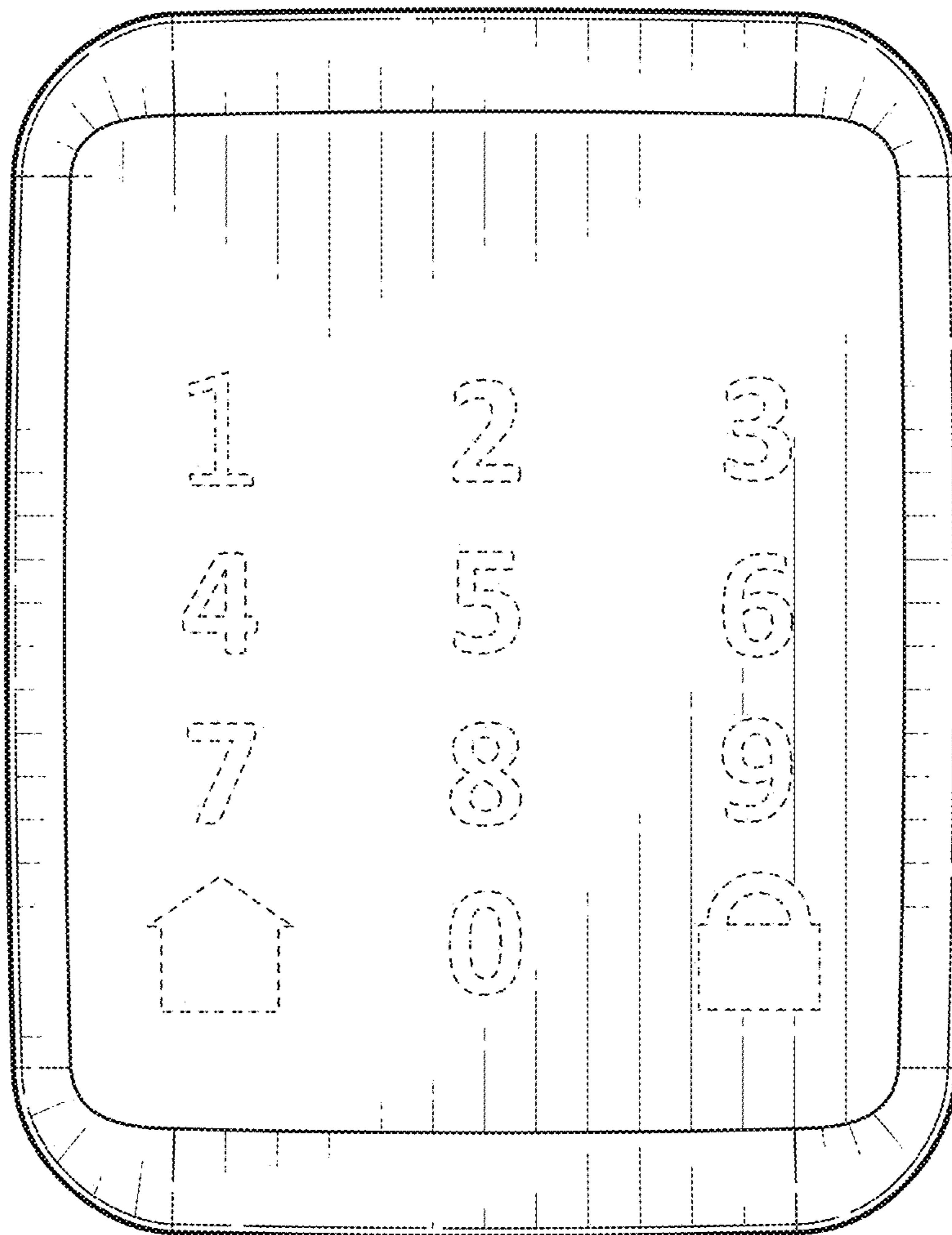


*Fig. 7*

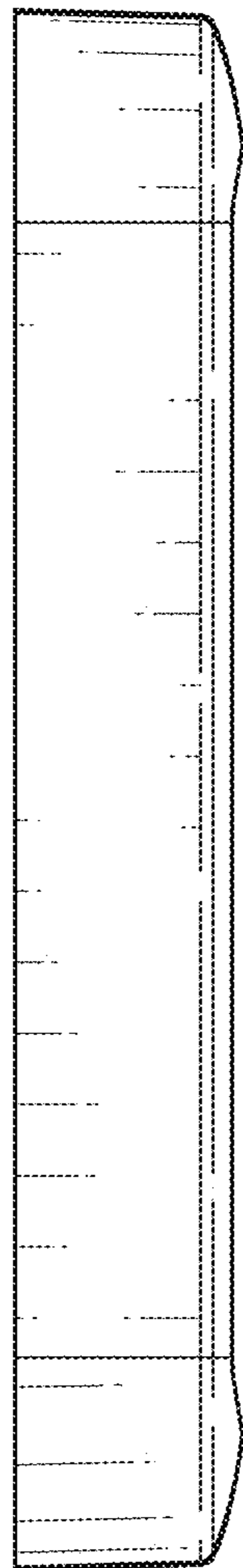


*Fig. 8*





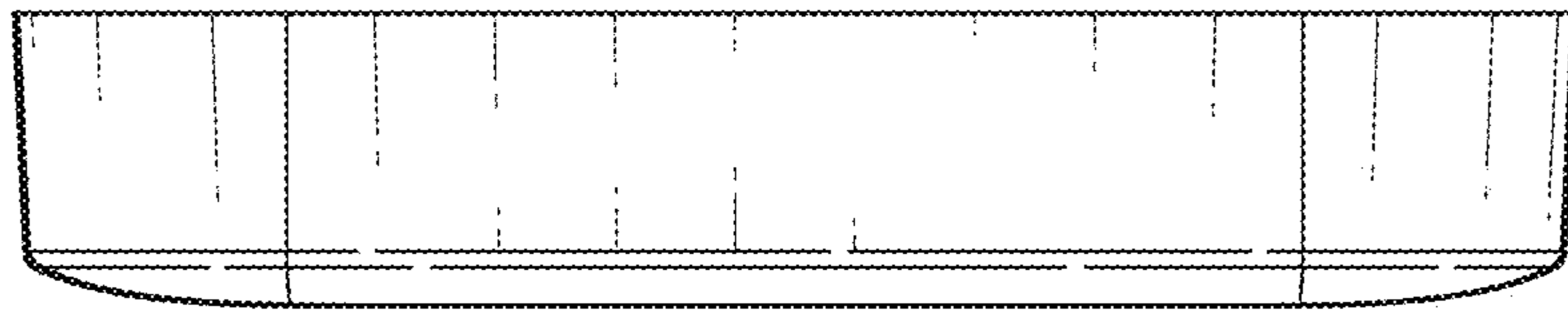
*Fig. 9*



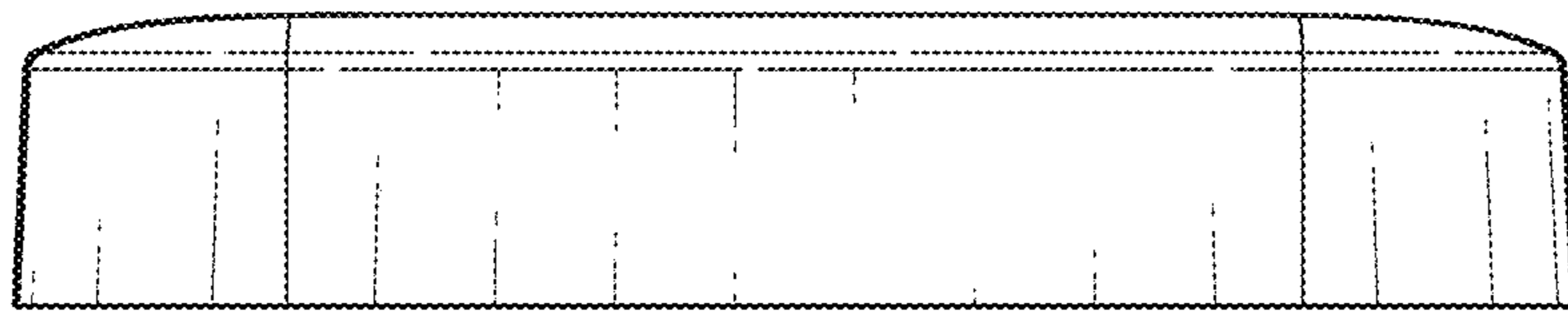
*Fig. 10*



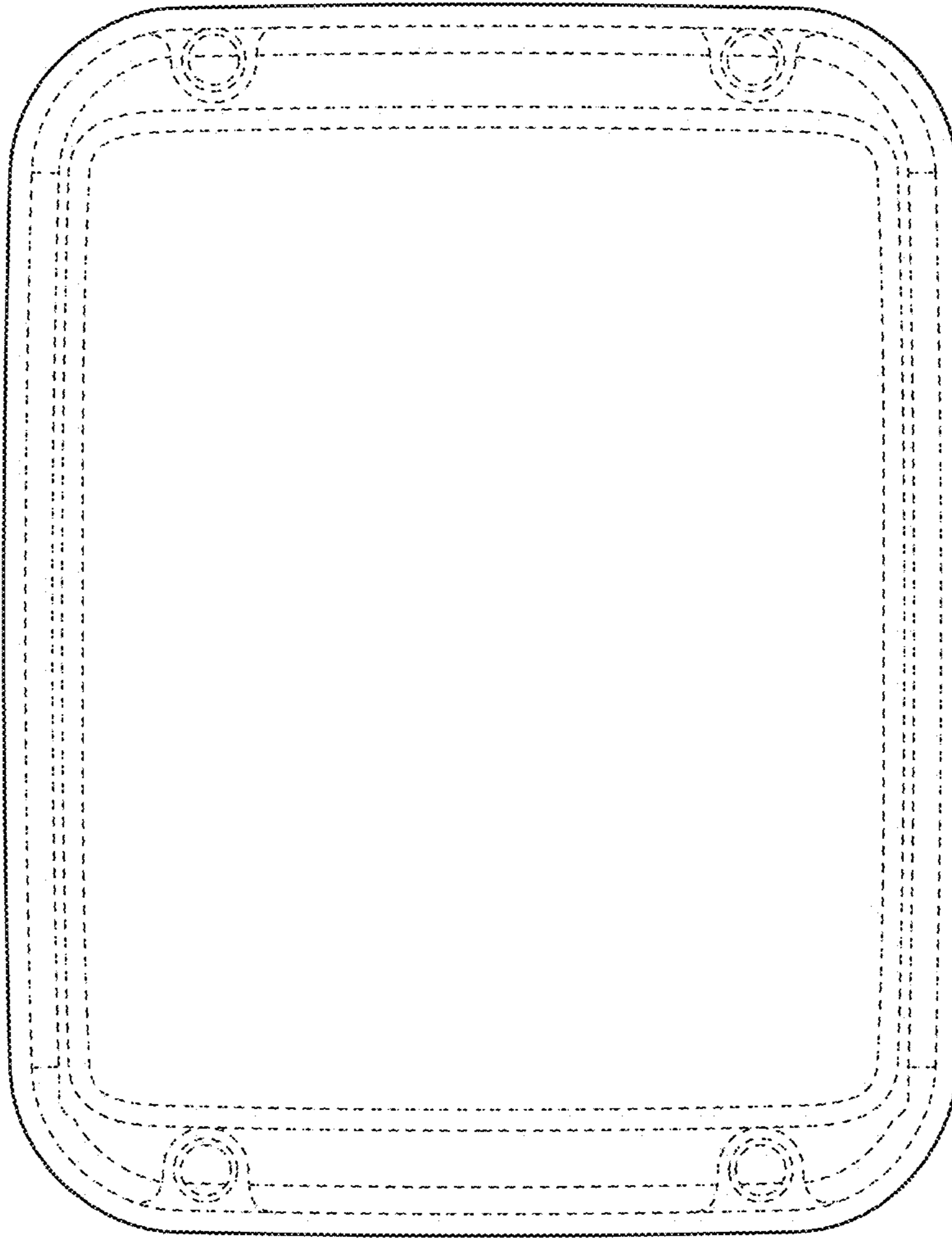
*Fig. 11*



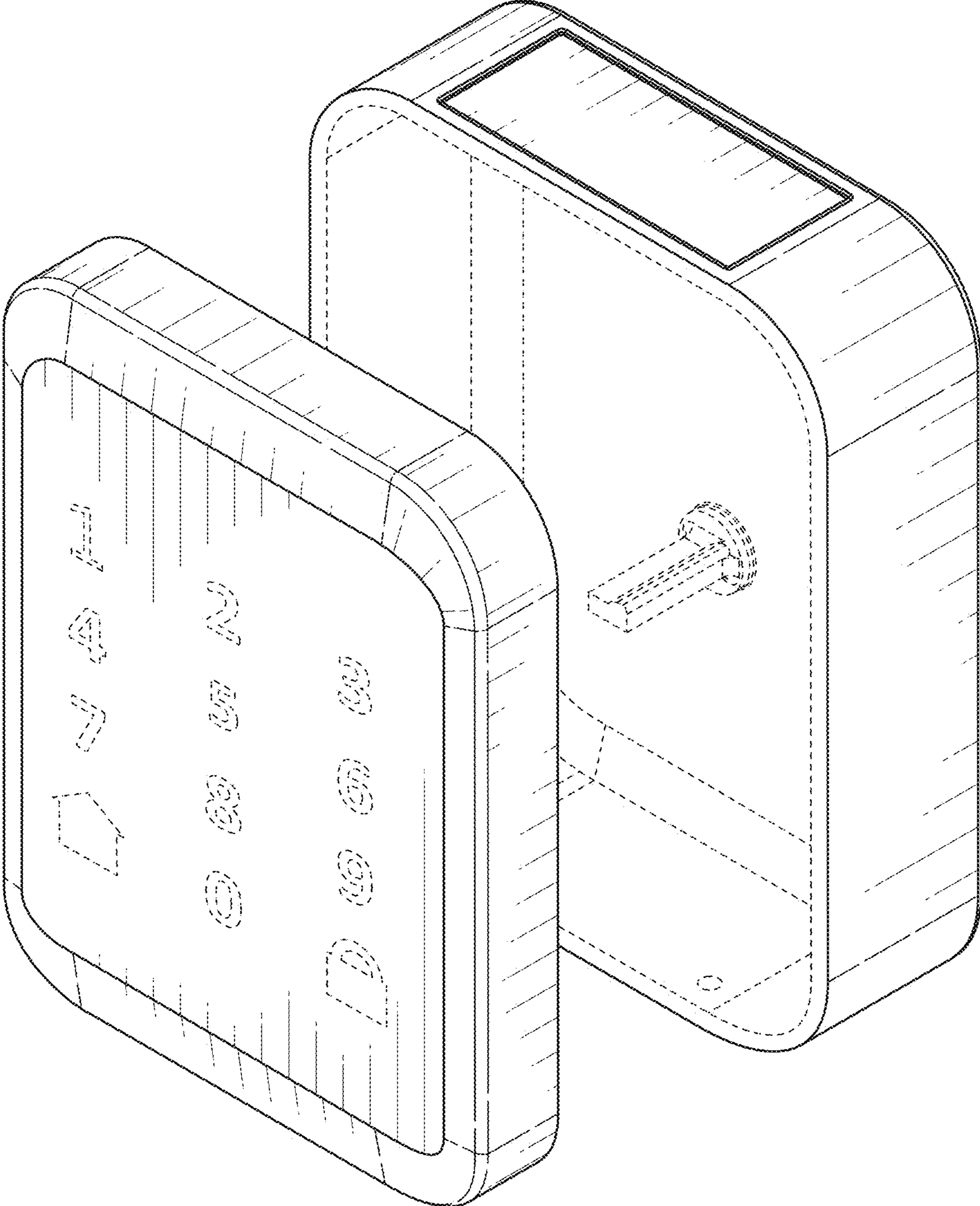
*Fig. 12*



*Fig. 13*



*Fig. 14*



*Fig. 15*