



US00D888499S

(12) **United States Design Patent** (10) **Patent No.:** **US D888,499 S**  
**McGee, Jr. et al.** (45) **Date of Patent:** **\*\* \*Jun. 30, 2020**

(54) **DRINKING VESSEL**  
(71) Applicant: **SAMIAM GROUP, LLC**, Hartford, CT (US)  
(72) Inventors: **Samuel McGee, Jr.**, Hartford, CT (US); **Derrick Johnson**, Avon, CT (US); **Brett Virgl**, Cedar Rapids, IA (US)  
(73) Assignee: **SAMIAM GROUP, LLC**, Hartford, CT (US)  
(\* ) Notice: This patent is subject to a terminal disclaimer.  
(\*\*) Term: **15 Years**  
(21) Appl. No.: **29/662,759**  
(22) Filed: **Sep. 7, 2018**  
(51) **LOC (12) Cl.** ..... **07-01**  
(52) **U.S. Cl.**  
USPC ..... **D7/515; D7/523**  
(58) **Field of Classification Search**  
USPC ..... D7/533-536, 509-511, 514, 515, 518, D7/523, 529, 532, 316-319, 524, 528,  
(Continued)

(56) **References Cited**  
**U.S. PATENT DOCUMENTS**  
D21,149 S \* 11/1891 Wilhelm ..... D7/524  
D168,409 S \* 12/1952 Kell ..... D7/524  
(Continued)

**FOREIGN PATENT DOCUMENTS**  
KR 3000491820000 7/1984

**OTHER PUBLICATIONS**  
Hartford Yard Goats, "First baseball team ever to sell beer baseball bats . . .", Aug. 11, 2018, Twitter, <https://twitter.com/goyardgoats/status/1028344259001413634?lang=en> (Year: 2018).\*  
(Continued)

*Primary Examiner* — Brett Miller  
(74) *Attorney, Agent, or Firm* — Banner & Witcoff, Ltd.

(57) **CLAIM**

The ornamental design for a drinking vessel, as shown and described.

**DESCRIPTION**

FIG. 1 is a top front perspective view of a drinking vessel showing our new design;  
FIG. 2 is a front view thereof;  
FIG. 3 is a rear view thereof;  
FIG. 4 is a right side view thereof;  
FIG. 5 is a left side view thereof;  
FIG. 6 is a top view thereof;  
FIG. 7 is a bottom view thereof;  
FIG. 8 is a cross-sectional view taken along 8-8 of FIG. 6;  
FIG. 9 is a top front perspective view of an alternative embodiment of a drinking vessel showing our new design;  
FIG. 10 is a front view thereof;  
FIG. 11 is a rear view thereof;  
FIG. 12 is a right side view thereof;  
FIG. 13 is a left side view thereof;  
FIG. 14 is a top view thereof;  
FIG. 15 is a bottom view thereof; and,  
FIG. 16 is a cross-sectional view taken along 16-16 of FIG. 14.  
The even-length broken lines depicting of the unshaded elements of the drinking vessel in FIGS. 8 and 16 show features that form no part of the claimed design. The uneven-length broken lines depicting the remainder of the drinking vessel in FIGS. 6 and 14 show features that form no part of the claimed design.

**1 Claim, 10 Drawing Sheets**

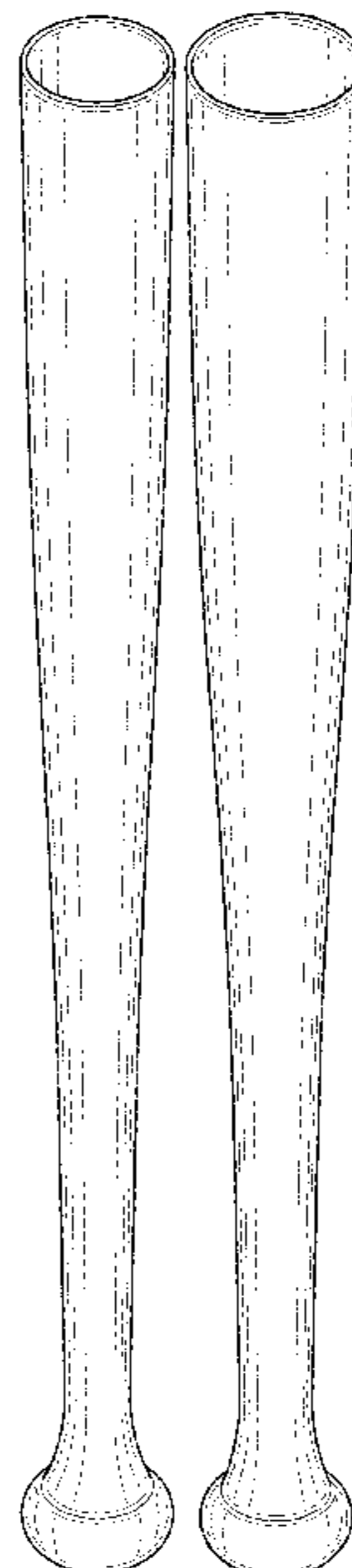

(58) **Field of Classification Search**

USPC .. D7/607, 608, 619.1, 624.2, 521, 530, 537;  
D9/552, 554, 565, 668; D11/146, 153,  
D11/152; D21/725

CPC ..... A47G 19/2205; A47G 19/2288; B65D  
81/3876

See application file for complete search history.

(56) **References Cited**

U.S. PATENT DOCUMENTS

D217,090 S \* 4/1970 Angelakos ..... D7/523  
D386,678 S \* 11/1997 Tyra ..... D21/725  
D400,051 S \* 10/1998 Miyagi ..... D7/524  
D400,395 S \* 11/1998 Wilson ..... D7/396.6  
D405,685 S \* 2/1999 Rusnock ..... D9/549  
D419,379 S \* 1/2000 Madden ..... D7/515  
D435,194 S \* 12/2000 Betras ..... D7/510  
D446,748 S \* 8/2001 Hutton ..... D11/146  
D474,519 S \* 5/2003 Filice ..... D21/725  
D482,749 S \* 11/2003 Gumpel ..... D21/725  
D594,515 S \* 6/2009 Giblin ..... D21/725  
D604,560 S \* 11/2009 Priest ..... D7/507  
D626,612 S \* 11/2010 Fitzgerald ..... D21/725  
D698,497 S \* 1/2014 Smith ..... D28/76

D717,603 S \* 11/2014 Federighi ..... D7/509  
D717,604 S \* 11/2014 Klinge ..... D7/523  
D718,576 S \* 12/2014 Hinterleitner ..... D7/523  
D719,034 S \* 12/2014 Sauczuk ..... D21/725  
D732,870 S \* 6/2015 Hollander ..... D7/300.2  
D765,341 S \* 9/2016 Porody ..... D1/105  
D801,119 S \* 10/2017 Petre ..... D7/523  
D809,867 S \* 2/2018 Leigh ..... D7/523  
D821,817 S \* 7/2018 Di Giuseppantonio ..... D7/524  
D873,138 S \* 1/2020 Cramton ..... D9/451  
2004/0209716 A1 \* 10/2004 Vacek ..... A63B 59/54  
473/567

OTHER PUBLICATIONS

CREE Q5 LED, Aug. 24, 2018 (review date), DHgate.com, <https://www.dhgate.com/product/new-cree-q5-led-tactical-flashlight-torch/406164114.html#seo=WAP> (Year: 2018).  
ThirstBat, Apr. 21, 2017 (page last updated), Kickstarter, <https://www.kickstarter.com/projects/423469748/thirstbat> (Year: 2017).  
Baseball Bat Mug | Personalized Gifts for Players, Coaches & Fans [online], [retrieved Sep. 5, 2018], Retrieved from [dugoutmugs.com](http://dugoutmugs.com) [Internet] <URL: <https://dugoutmugs.com/> [date unknown but prior to filing date]>.

\* cited by examiner

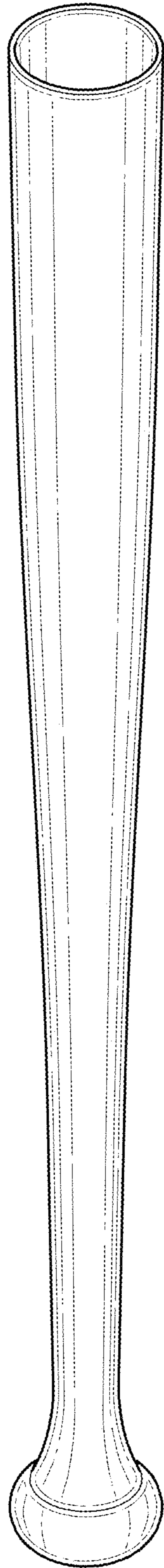

FIG. 1

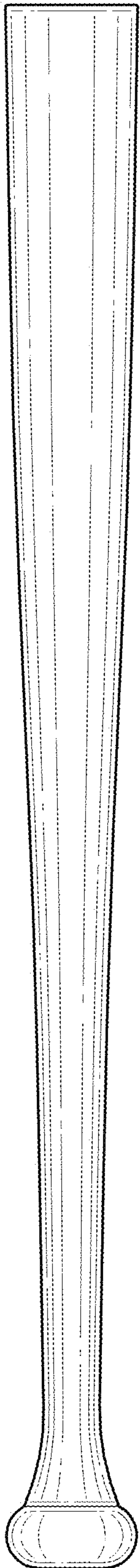

FIG. 2

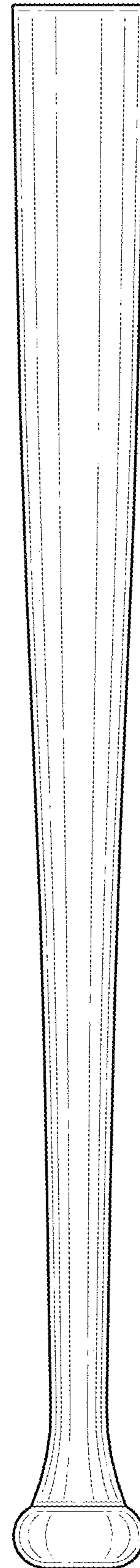

FIG. 3

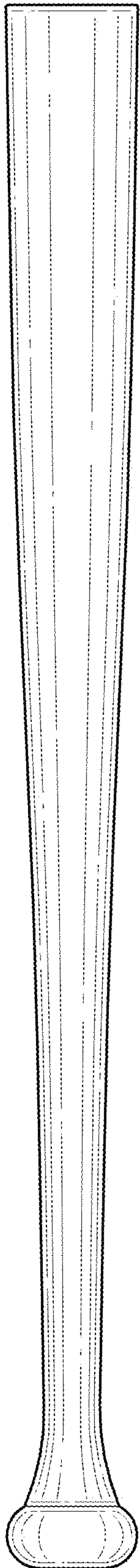

FIG. 4

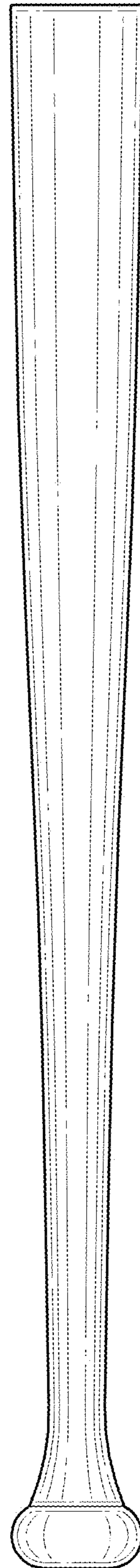
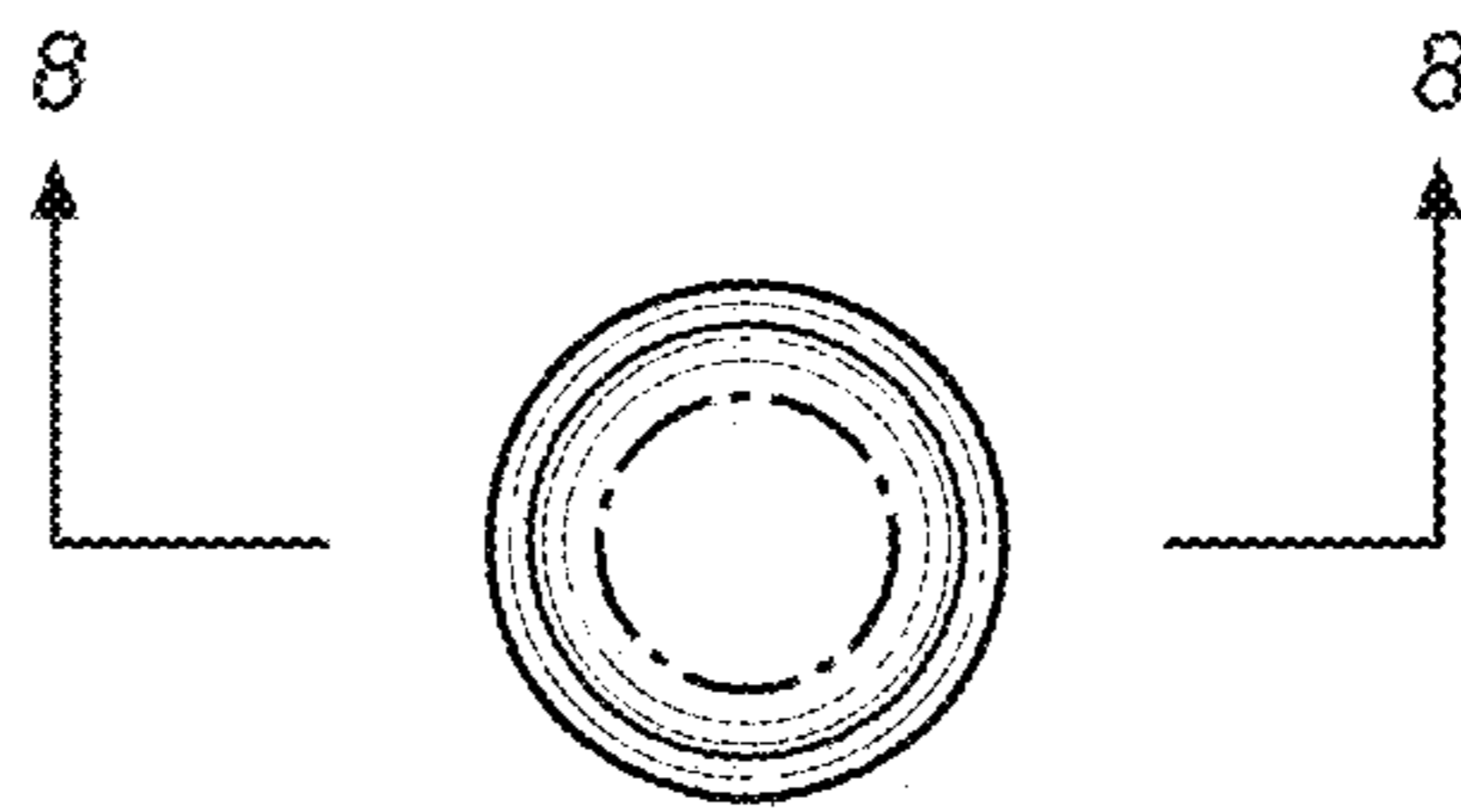
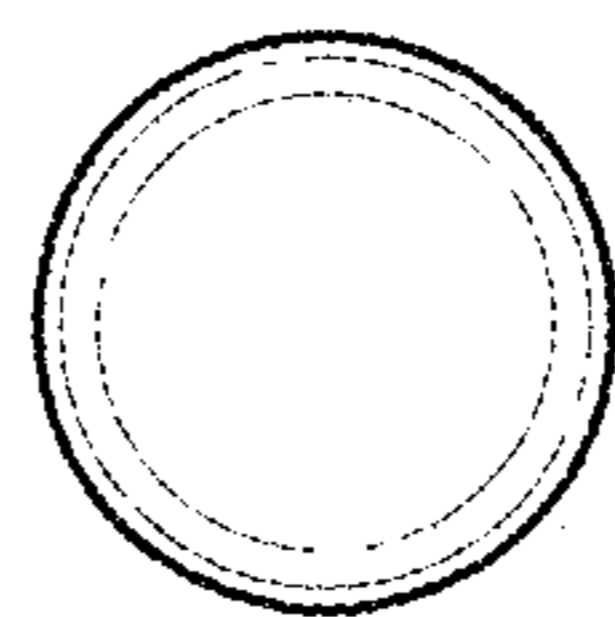

FIG. 5



**FIG. 6**



**FIG. 7**

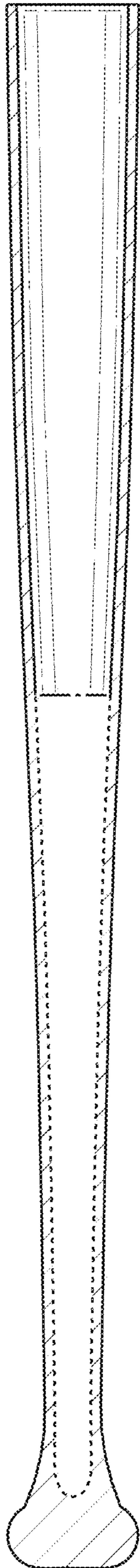
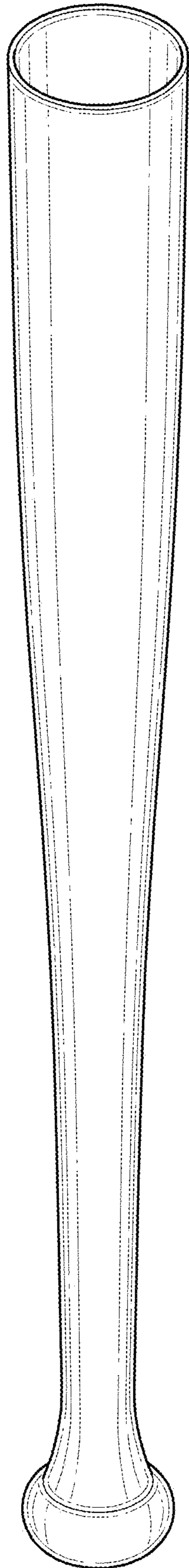

FIG. 8



**FIG. 9**



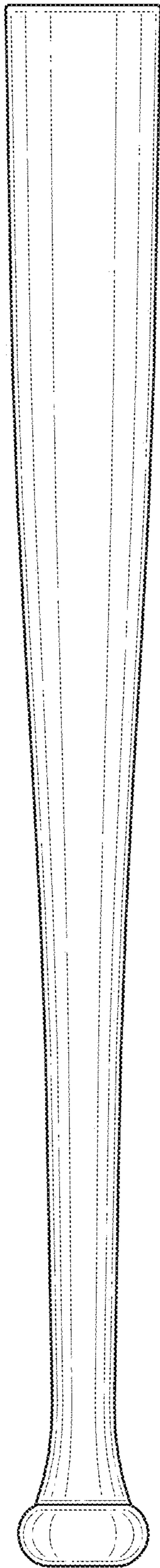

FIG. 10

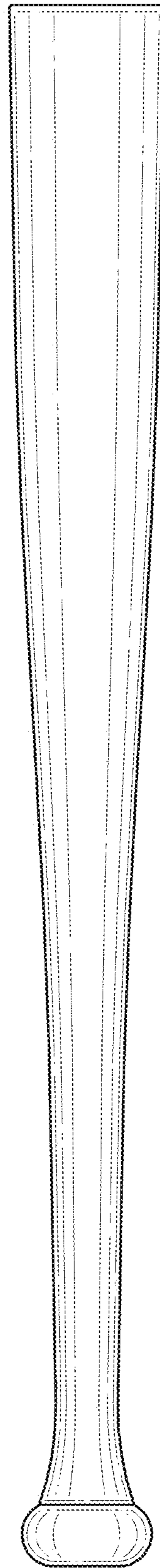

FIG. 11

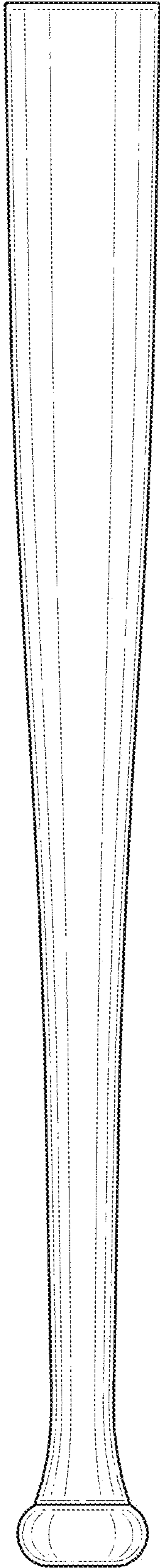

FIG. 12

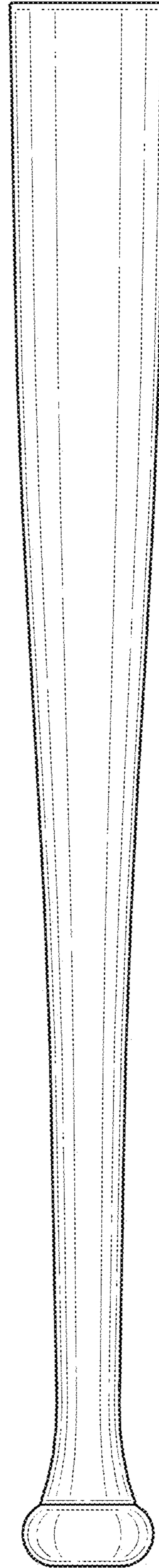

FIG. 13

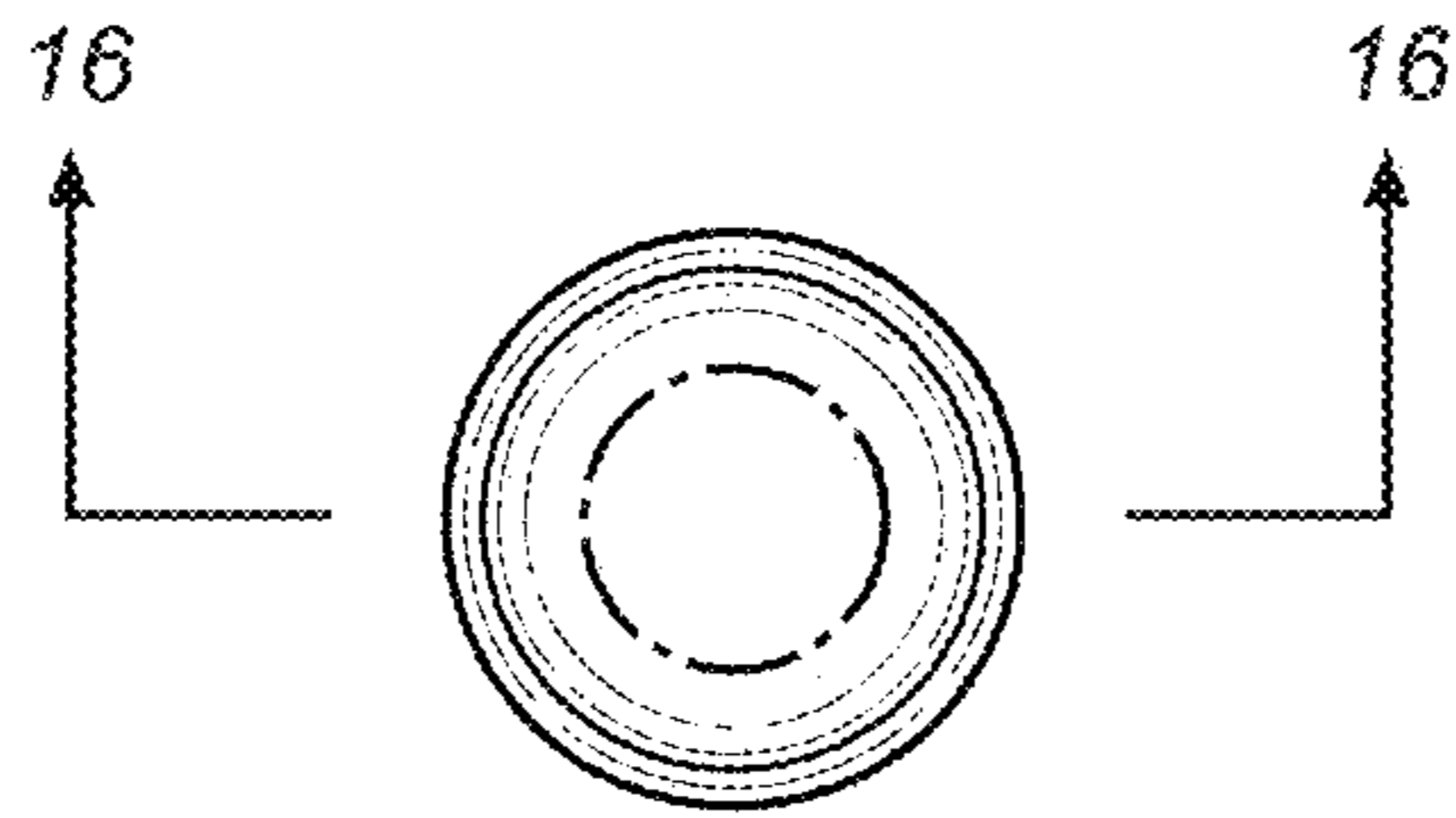

FIG. 14

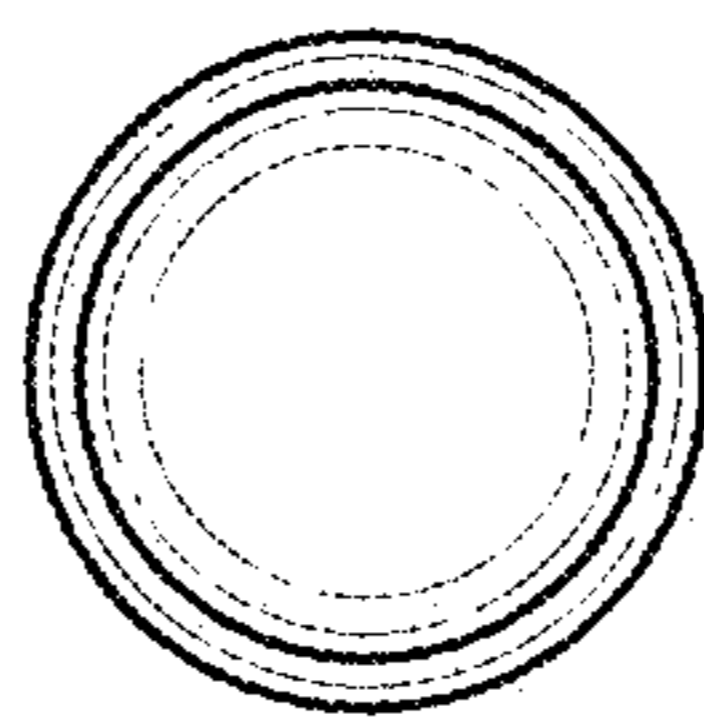

FIG. 15

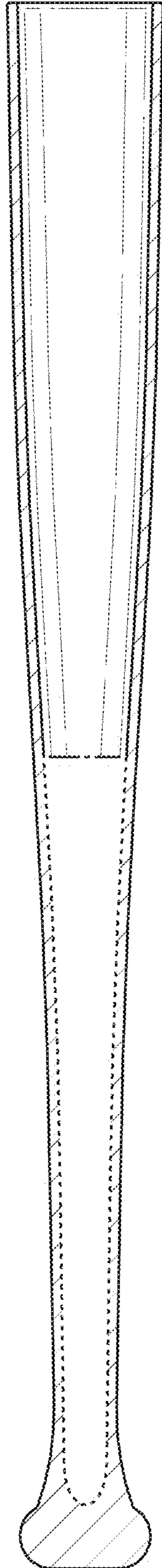

FIG. 16