



US00D888416S

(12) **United States Design Patent**
Amat

(10) **Patent No.:** **US D888,416 S**
(45) **Date of Patent:** **** Jun. 30, 2020**

(54) **HANDBAG**

(71) Applicant: **J. Choo Limited**, London (GB)

(72) Inventor: **Lina Amat**, London (GB)

(73) Assignee: **J. Choo Limited**, London (GB)

(**) Term: **15 Years**

(21) Appl. No.: **29/619,354**

(22) Filed: **Sep. 28, 2017**

(30) **Foreign Application Priority Data**

Apr. 3, 2017 (EM) 003838283-0008

(51) **LOC (12) Cl.** **03-01**

(52) **U.S. Cl.**
USPC **D3/232; D3/243**

(58) **Field of Classification Search**
USPC **D3/232-253, 273-277, 292, 303, 304, D3/285, 287, 318**

CPC .. **A45C 1/024; A45C 3/04; A45C 3/06; A45C 3/08; A45C 3/10; A45C 7/0059; A45C 7/0077; A45C 13/08; A45C 13/26; A45C 2001/083**

See application file for complete search history.

(56) **References Cited**

U.S. PATENT DOCUMENTS

D121,435 S *	7/1940	Goldsmith	D3/241
D127,933 S *	6/1941	Lewis	D3/245
D127,934 S *	6/1941	Lewis	D3/245
D134,558 S *	12/1942	Tashman	D3/243
D582,156 S *	12/2008	Gonzalez	D3/245
D669,264 S *	10/2012	Gonzalez	D3/243

D802,916 S * 11/2017 Koutsolioutsos D3/232

* cited by examiner

Primary Examiner — Cathron C Brooks

Assistant Examiner — Andrew T Nemeth

(74) *Attorney, Agent, or Firm* — Fross Zelnick Lehrman & Zissu, P.C.; Lawrence E. Apolzon, Esq.

(57) **CLAIM**

The ornamental design for a handbag, as shown and described.

DESCRIPTION

FIG. 1 is a front perspective view of a handbag showing my new design;

FIG. 1A is a cross-sectional view of the portion of the handbag indicated in FIG. 1;

FIG. 2 is a right side view thereof;

FIG. 3 is a left side view thereof;

FIG. 4 is a front view thereof;

FIG. 5 is a back view thereof;

FIG. 6 is a top view thereof;

FIG. 7 is a bottom view thereof;

FIG. 8 is a front perspective view of an alternative embodiment of the handbag shown in FIG. 1;

FIG. 8A is a cross-sectional view of the portion of the handbag indicated in FIG. 8;

FIG. 9 is a right side view thereof;

FIG. 10 is a left side view thereof;

FIG. 11 is a front view thereof;

FIG. 12 is a back view thereof;

FIG. 13 is a top view thereof; and,

FIG. 14 is a bottom view thereof.

The broken line showing of portions of the body of the bag, top decorative element, and jewel piece illustrate portions of the article that form no part of the claimed design.

1 Claim, 12 Drawing Sheets

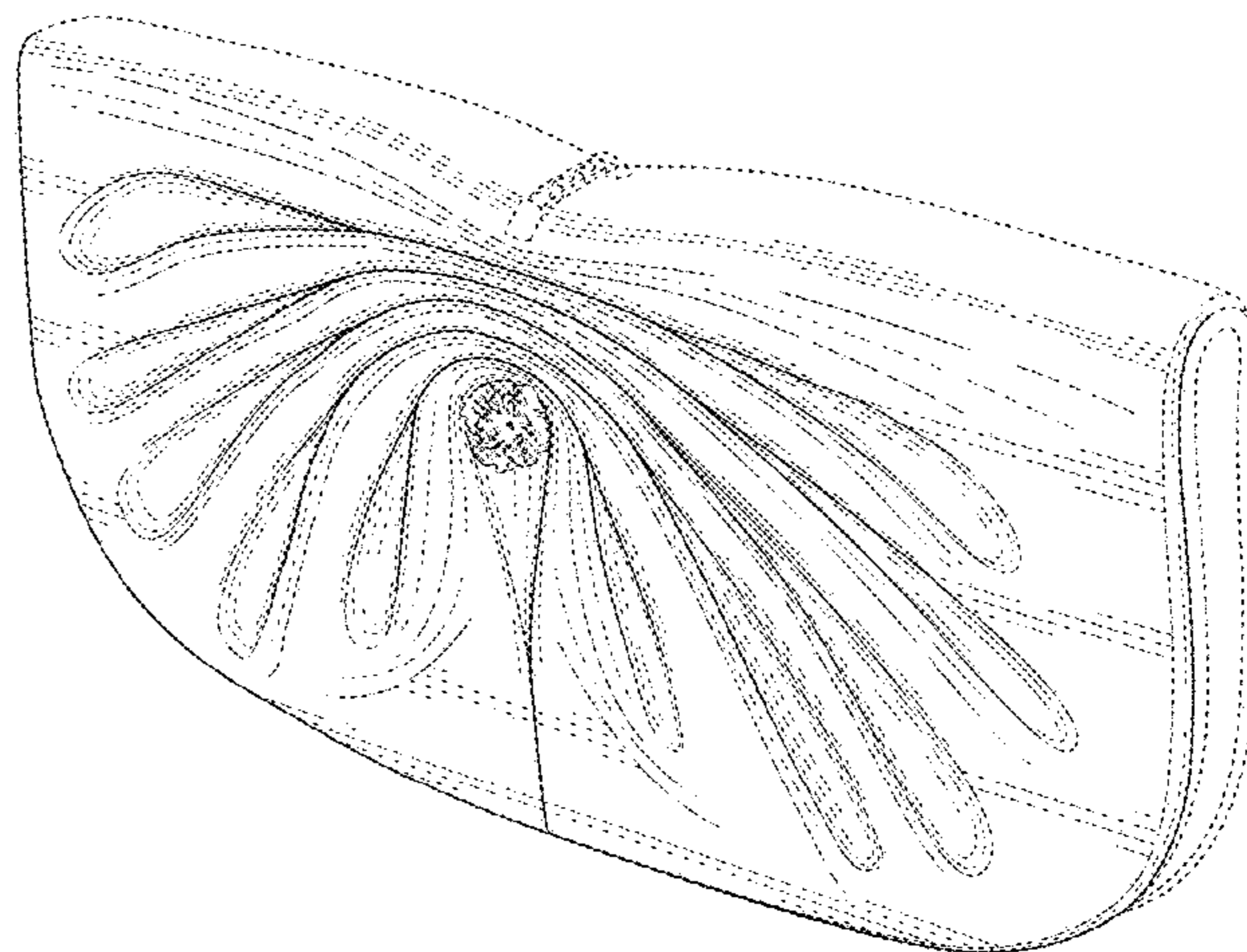
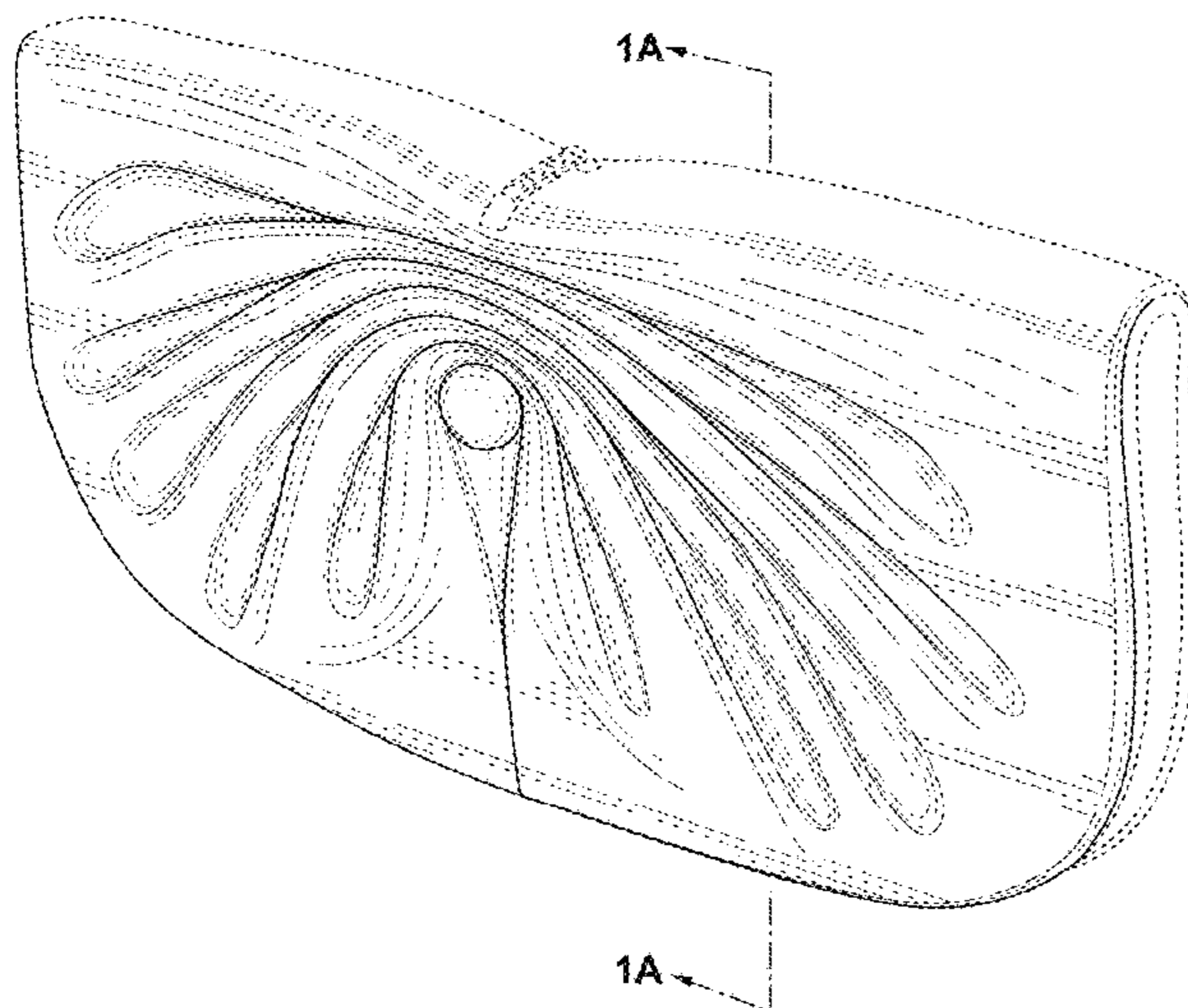

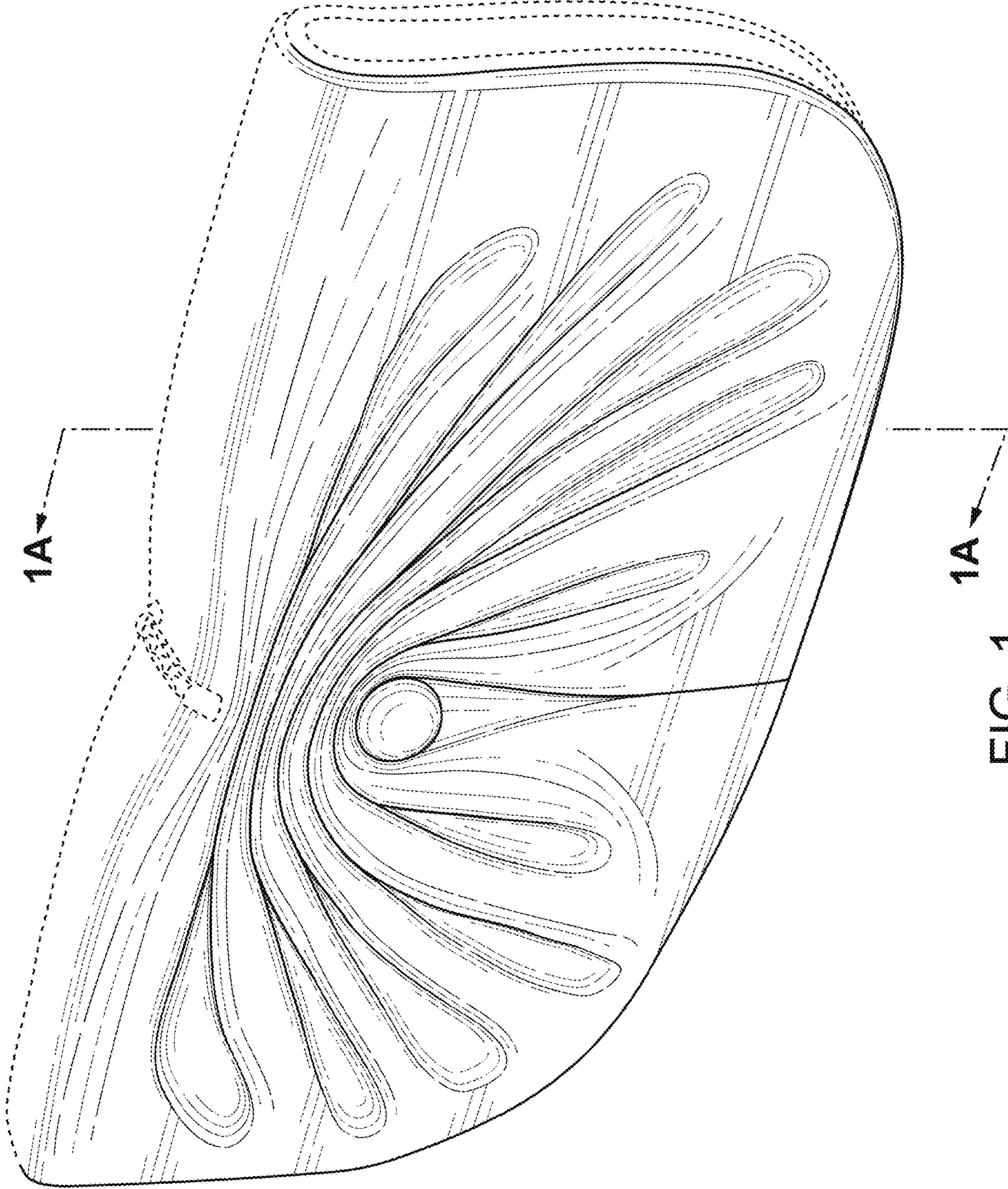

FIG. 1

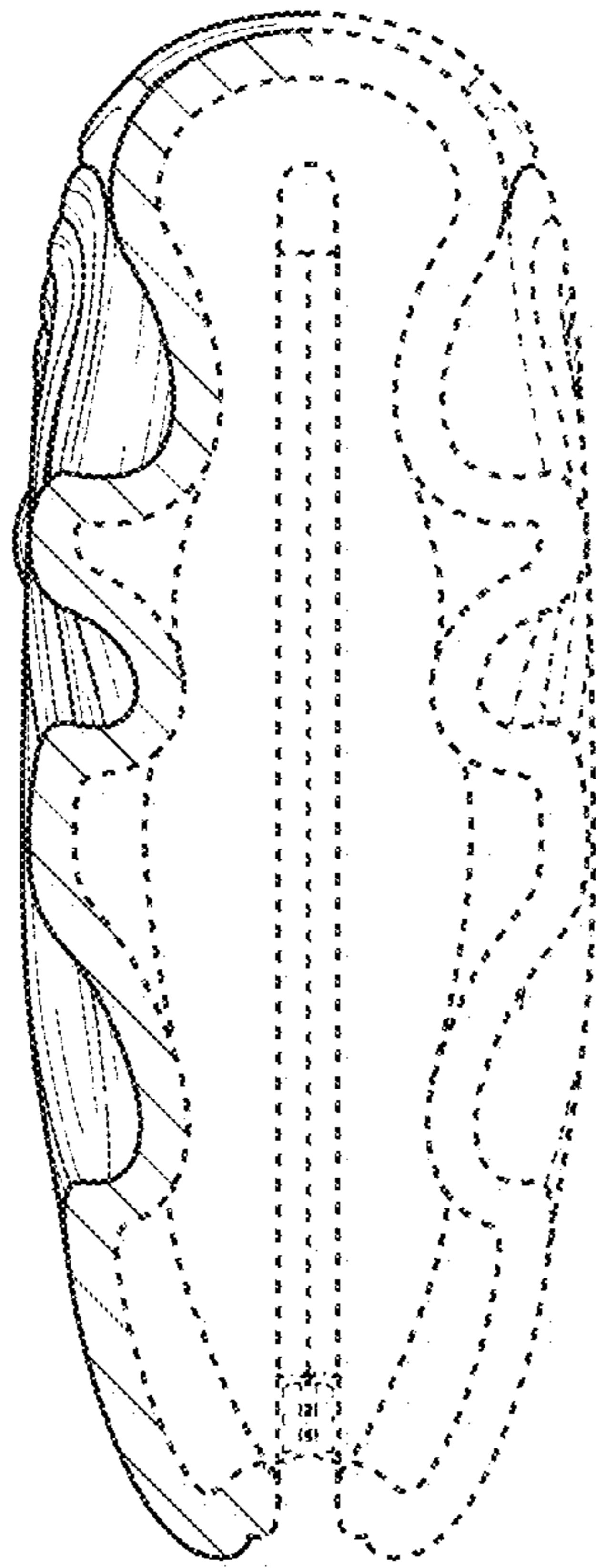

FIG. 1A

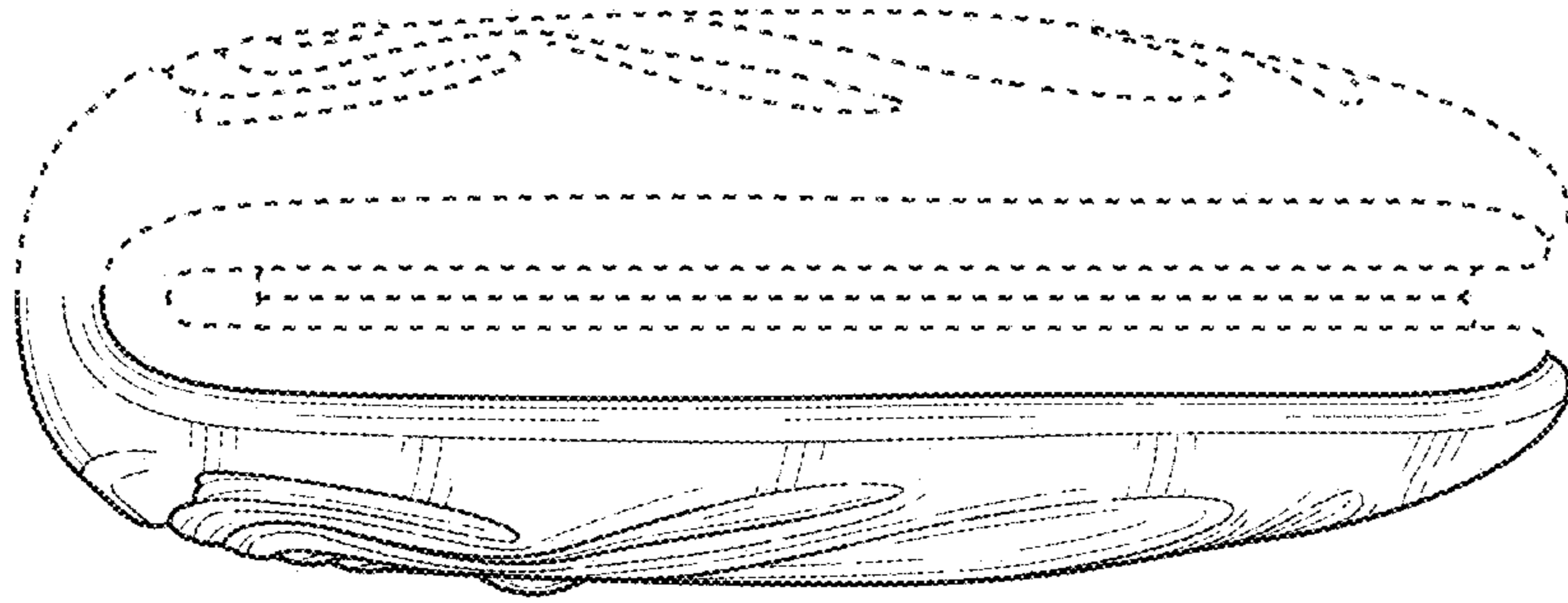

FIG. 3

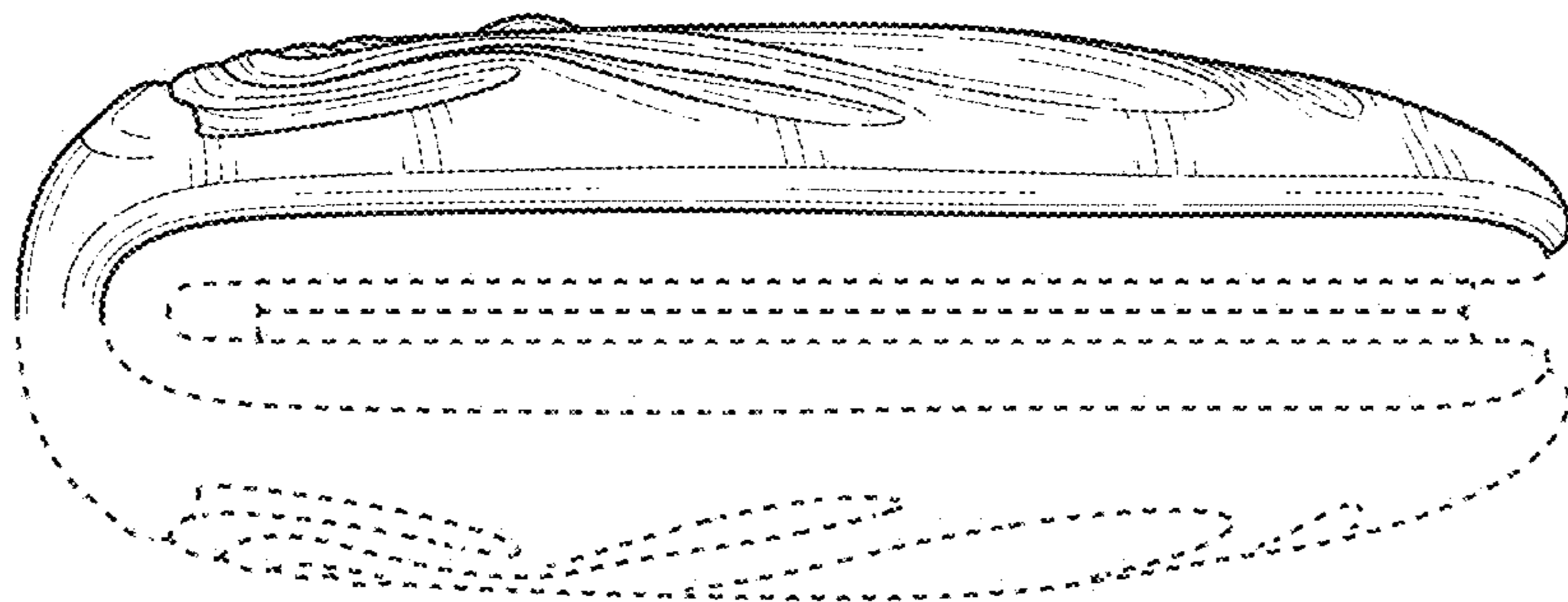

FIG. 2

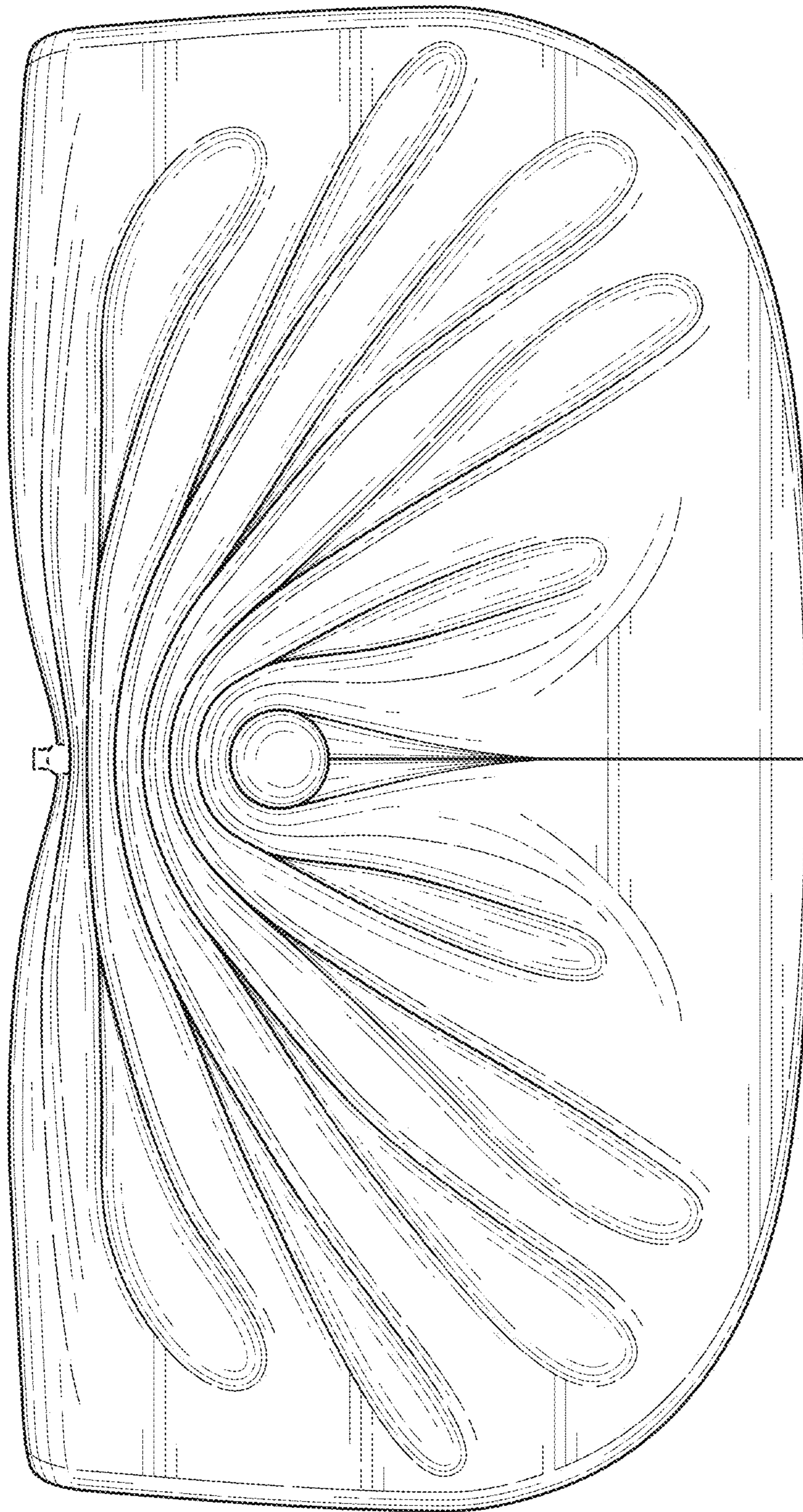

FIG. 4

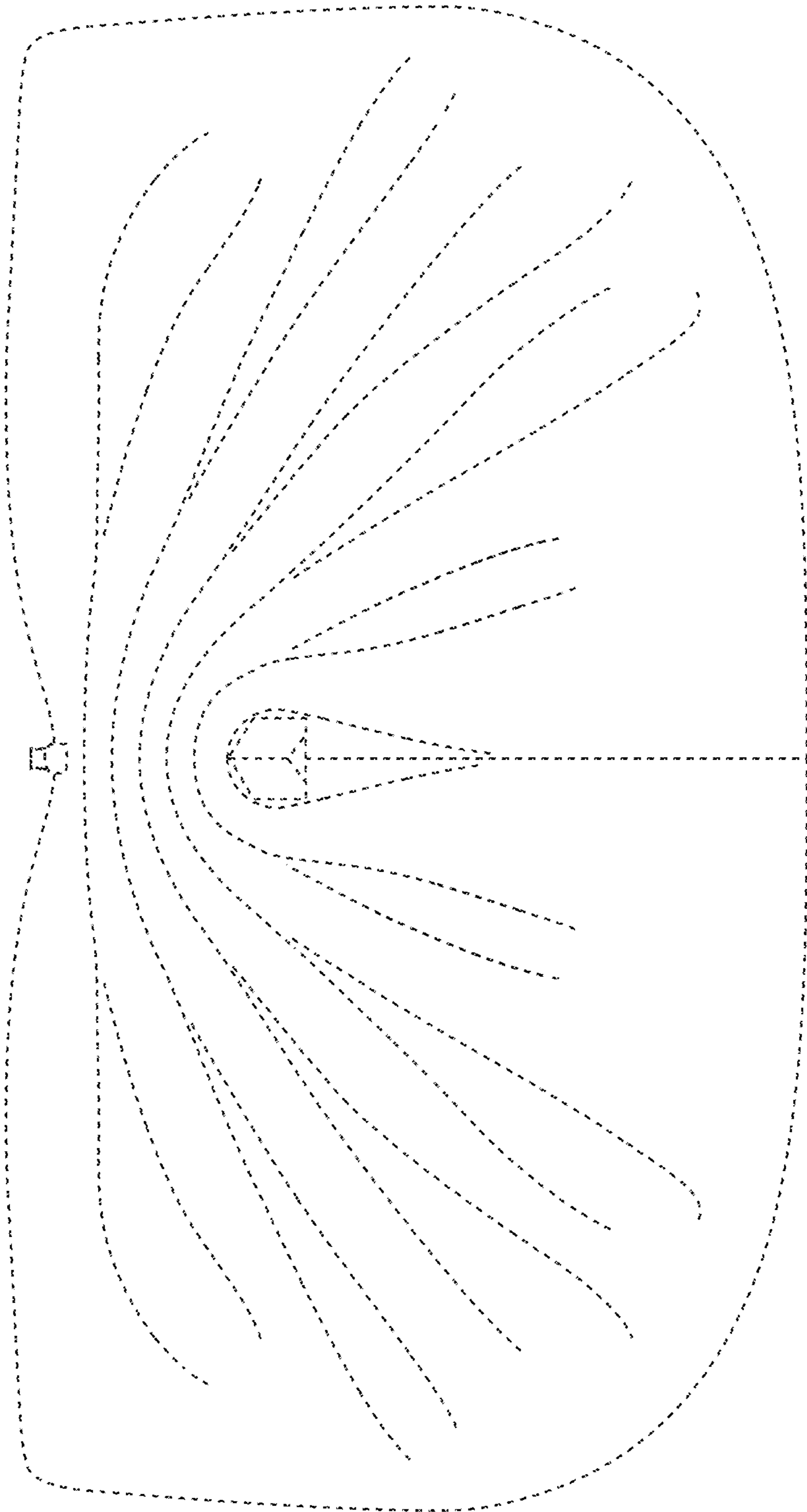

FIG. 5

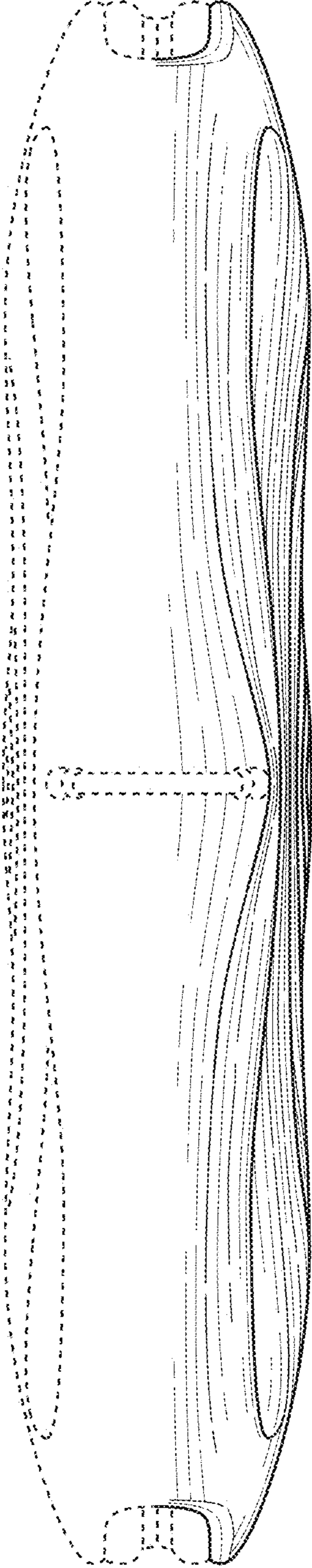

FIG. 6

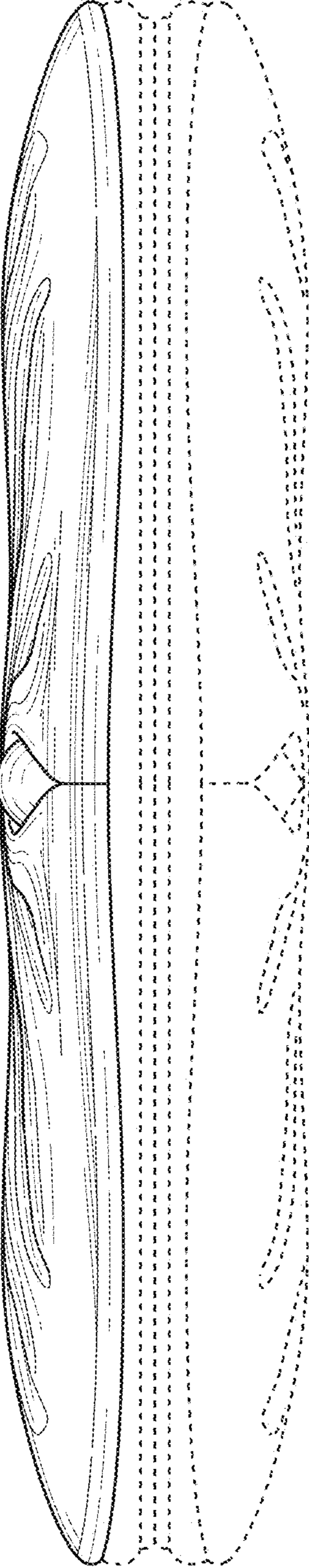

FIG. 7

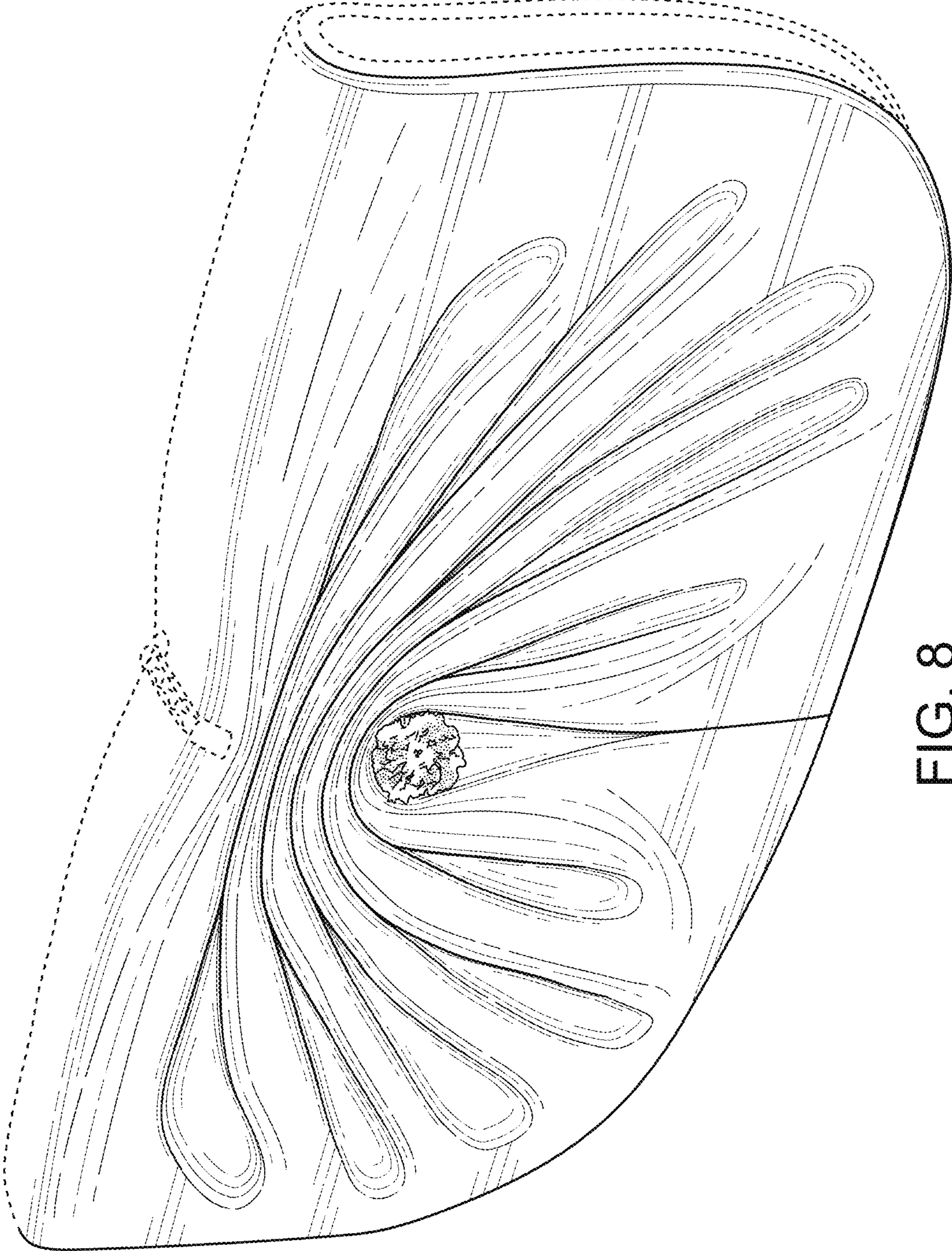

FIG. 8

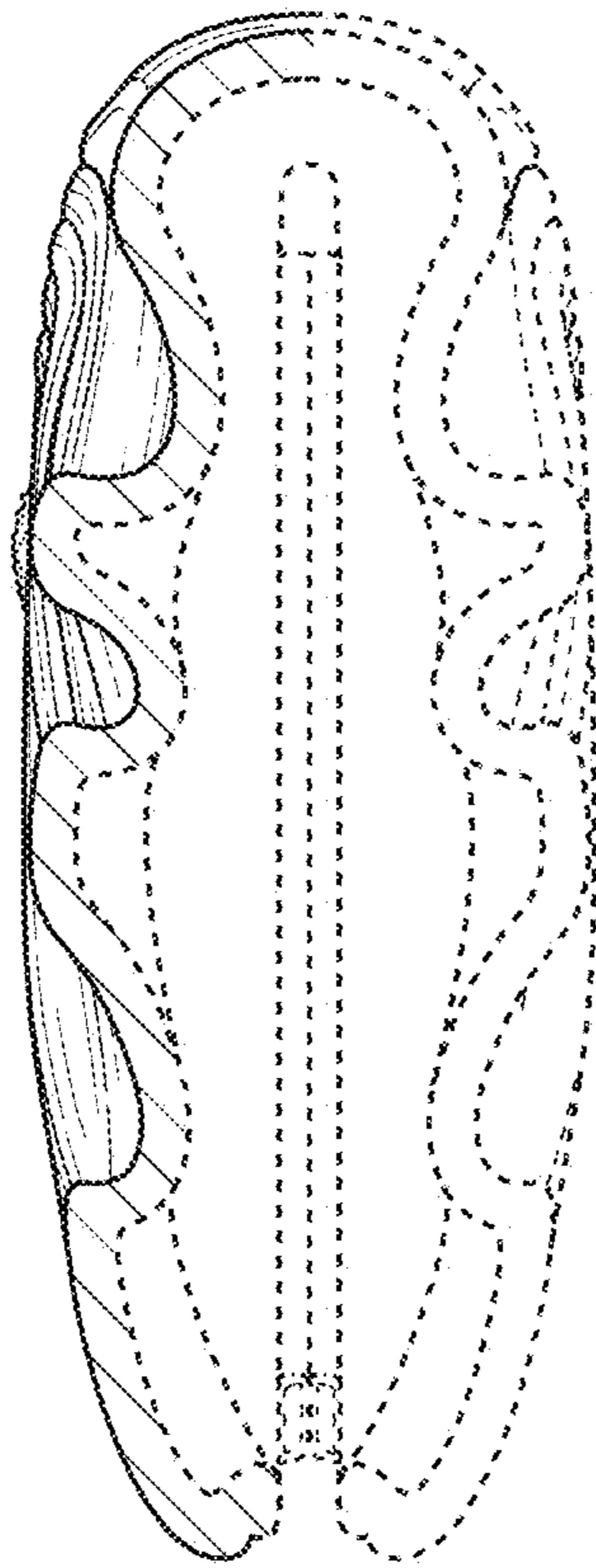

FIG. 8A

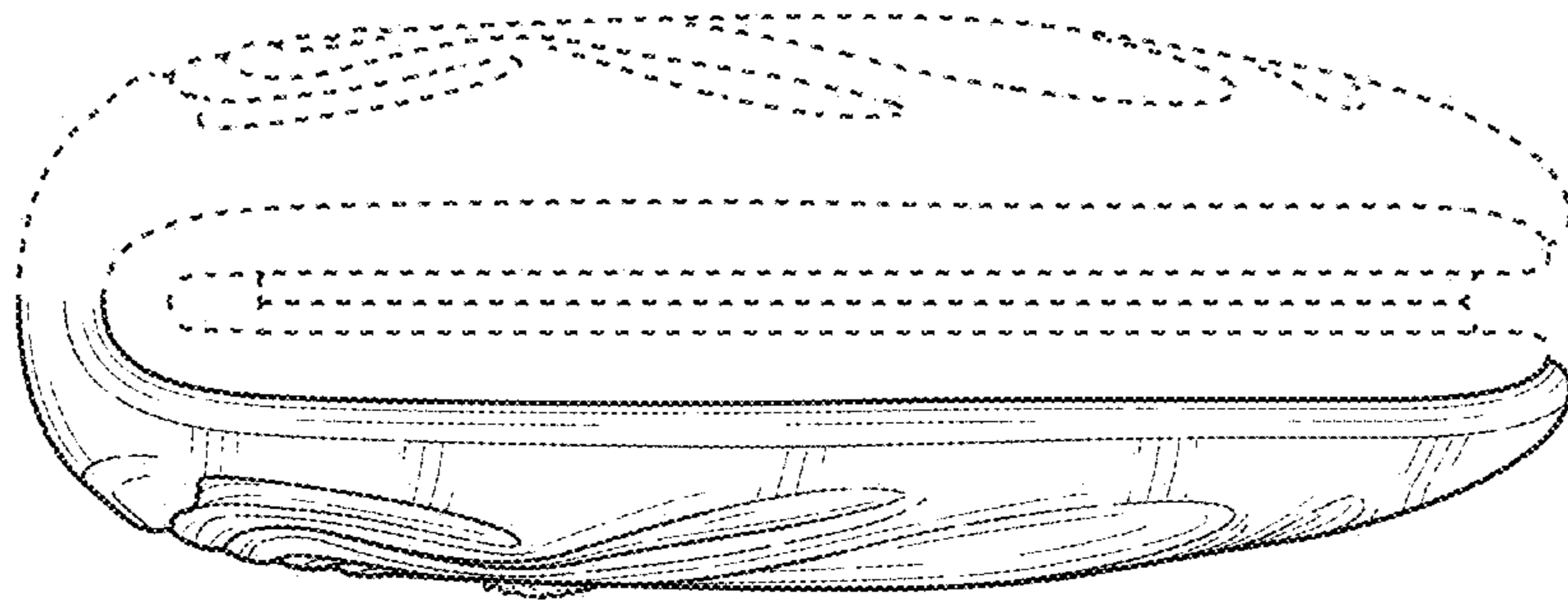

FIG. 10

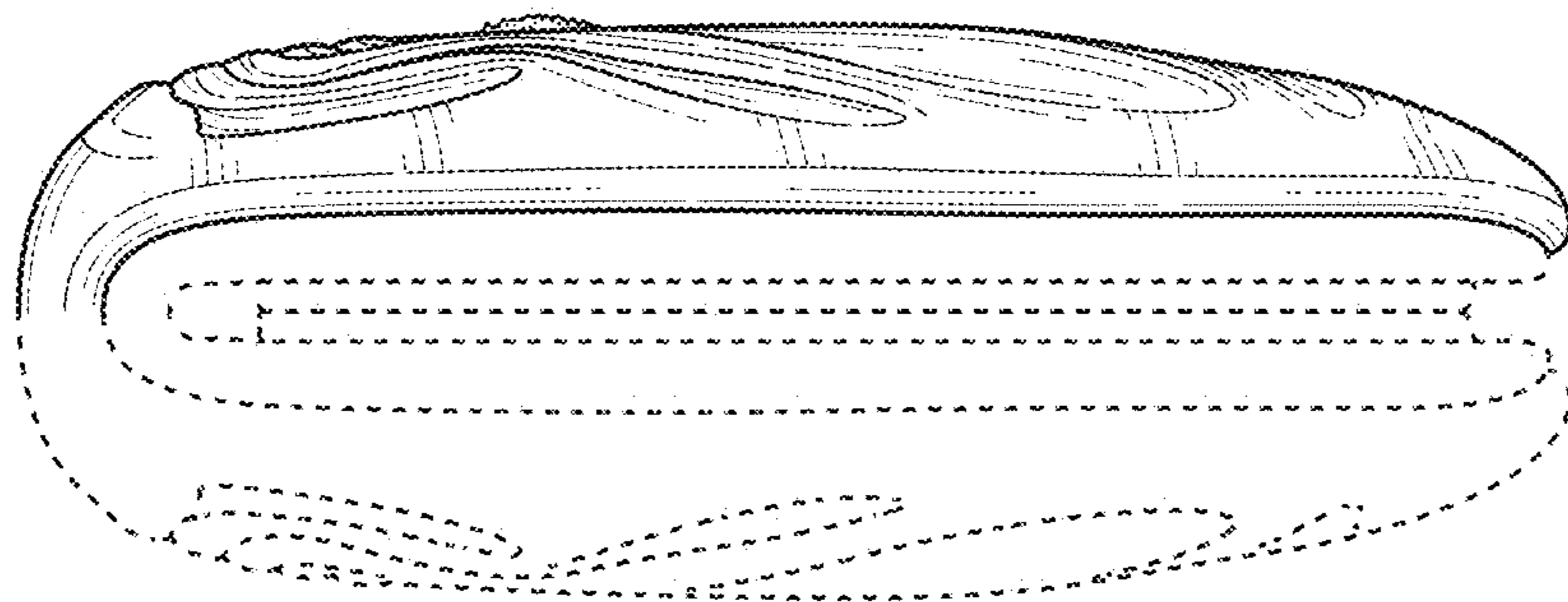

FIG. 9

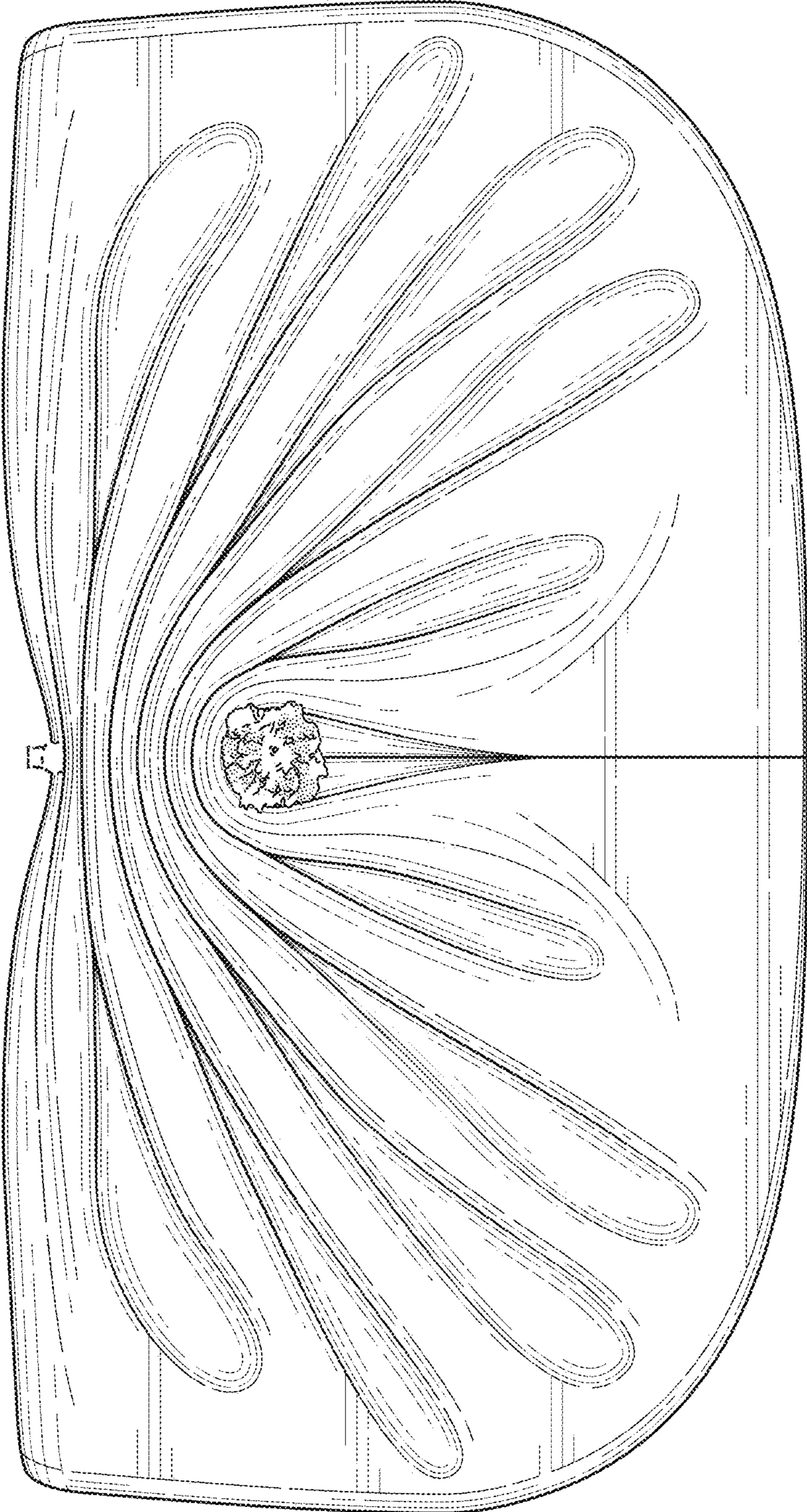

FIG. 11

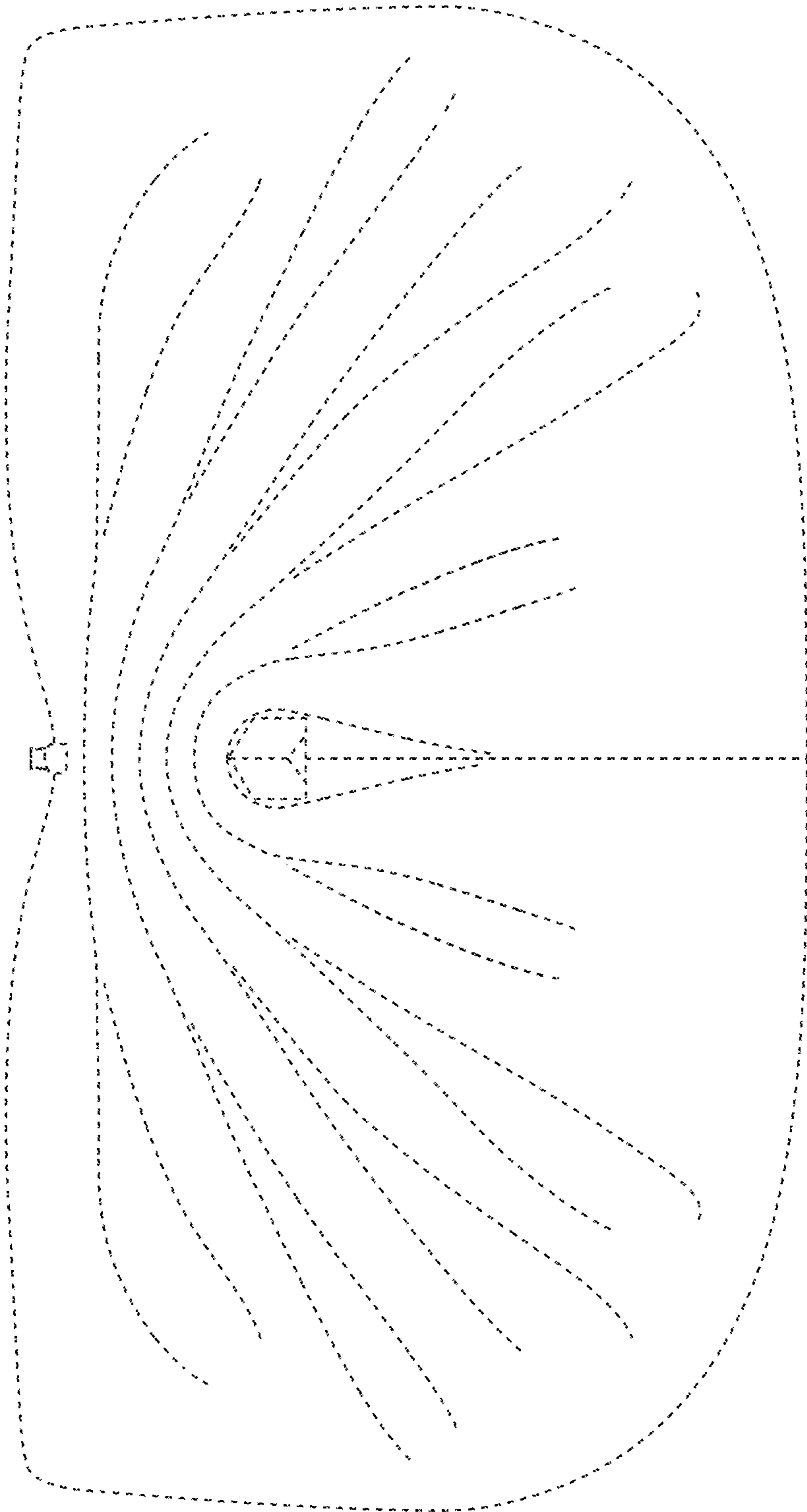

FIG. 12

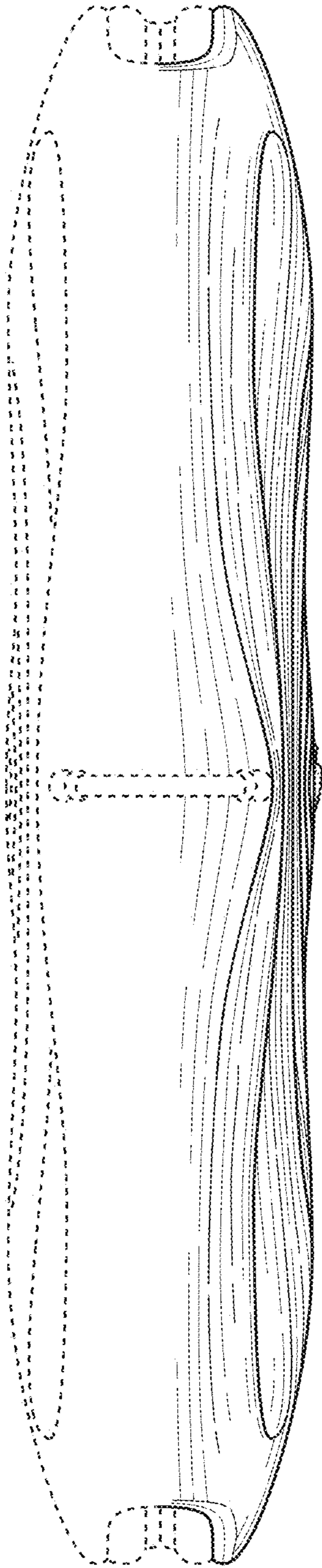

FIG. 13

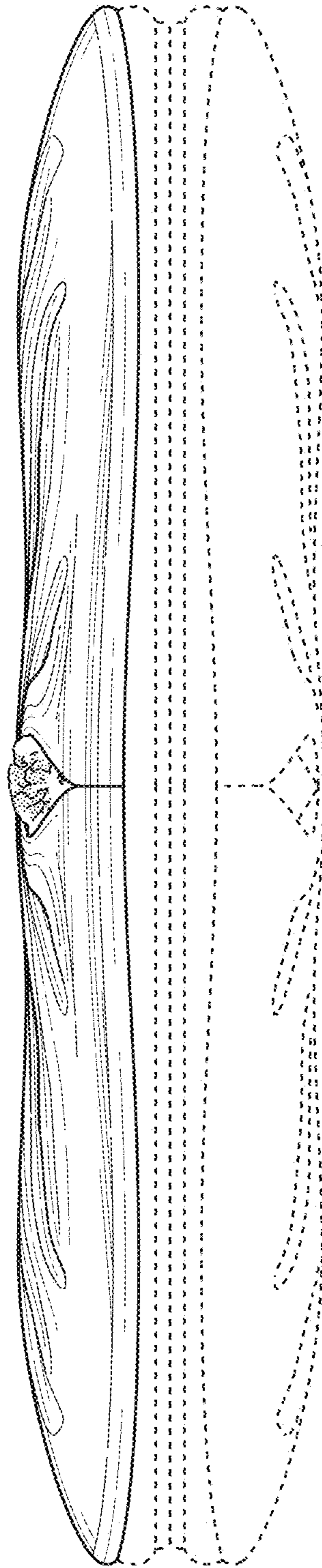

FIG. 14