



US00D888315S

(12) **United States Design Patent** (10) **Patent No.:** **US D888,315 S**  
**Velez** (45) **Date of Patent:** **\*\* Jun. 23, 2020**

(54) **LIGHT FIXTURE**

(71) Applicant: **Holly Hunt Enterprises, Inc.**, Chicago, IL (US)

(72) Inventor: **Alberto Velez**, Chicago, IL (US)

(73) Assignee: **HOLLY HUNT ENETERPRISES, INC.**, Chicago, IL (US)

(\*\*) Term: **15 Years**

(21) Appl. No.: **29/650,707**

(22) Filed: **Jun. 8, 2018**

(51) **LOC (12) Cl.** ..... **26-03**

(52) **U.S. Cl.**  
USPC ..... **D26/85; D26/89**

(58) **Field of Classification Search**  
USPC ..... D26/80-86, 88-91, 118, 74, 122, 124  
CPC .... F21S 8/04; F21S 8/043; F21S 8/046; F21S 8/061; F21S 8/063; F21S 8/065  
See application file for complete search history.

(56) **References Cited**

**U.S. PATENT DOCUMENTS**

D43,886 S *	4/1913	Mohr	.....	D26/83
D112,463 S *	12/1938	Levy	.....	D26/122
D117,834 S *	11/1939	Levy	.....	D26/122
D139,435 S *	11/1944	Cressaty	.....	D26/124
D162,543 S *	3/1951	Ingle	.....	D26/122
D169,972 S *	7/1953	Glatthar et al.	.....	D26/89
D171,443 S *	2/1954	Flett	.....	D26/122
D177,568 S *	5/1956	Hills	.....	D26/122
3,593,021 A *	7/1971	Auerbach	.....	F21V 17/105
				362/434
D297,267 S *	8/1988	Scowen	.....	D26/122

(Continued)

**OTHER PUBLICATIONS**

Textured White Wall Sconce No. 2694.98 by Sonneman, Available at build.com, visited Feb. 3, 2020. (Year: 2020).\*

(Continued)

*Primary Examiner* — Clare E Heflin

(74) *Attorney, Agent, or Firm* — The Belles Group, P.C.

(57) **CLAIM**

I claim the ornamental design for a light fixture, as shown and described.

**DESCRIPTION**

FIG. 1 is a front perspective view of a light fixture showing my new design according to a first embodiment of the present invention.

FIG. 2 is a front elevation view thereof.

FIG. 3 is a rear elevation view thereof.

FIG. 4 is a left side view thereof.

FIG. 5 is a right side view thereof.

FIG. 6 is a top plan view thereof.

FIG. 7 is a bottom plan view thereof.

FIG. 8 is a front perspective view of a light fixture showing my new design according to a second embodiment of the present invention.

FIG. 9 is a front elevation view thereof.

FIG. 10 is a rear elevation view thereof.

FIG. 11 is a right side view thereof.

FIG. 12 is a left side view thereof.

FIG. 13 is a top plan view thereof.

FIG. 14 is a bottom plan view thereof.

FIG. 15 is a front perspective view of a light fixture showing my new design according to a third embodiment of the present invention.

FIG. 16 is a front elevation view thereof.

FIG. 17 is a rear elevation view thereof.

FIG. 18 is a right side view thereof.

FIG. 19 is a left side view thereof.

FIG. 20 is a top plan view thereof; and,

FIG. 21 is a bottom plan view thereof.

The broken lines illustrate portions of the light fixture that form no part of the claimed design.

**1 Claim, 15 Drawing Sheets**

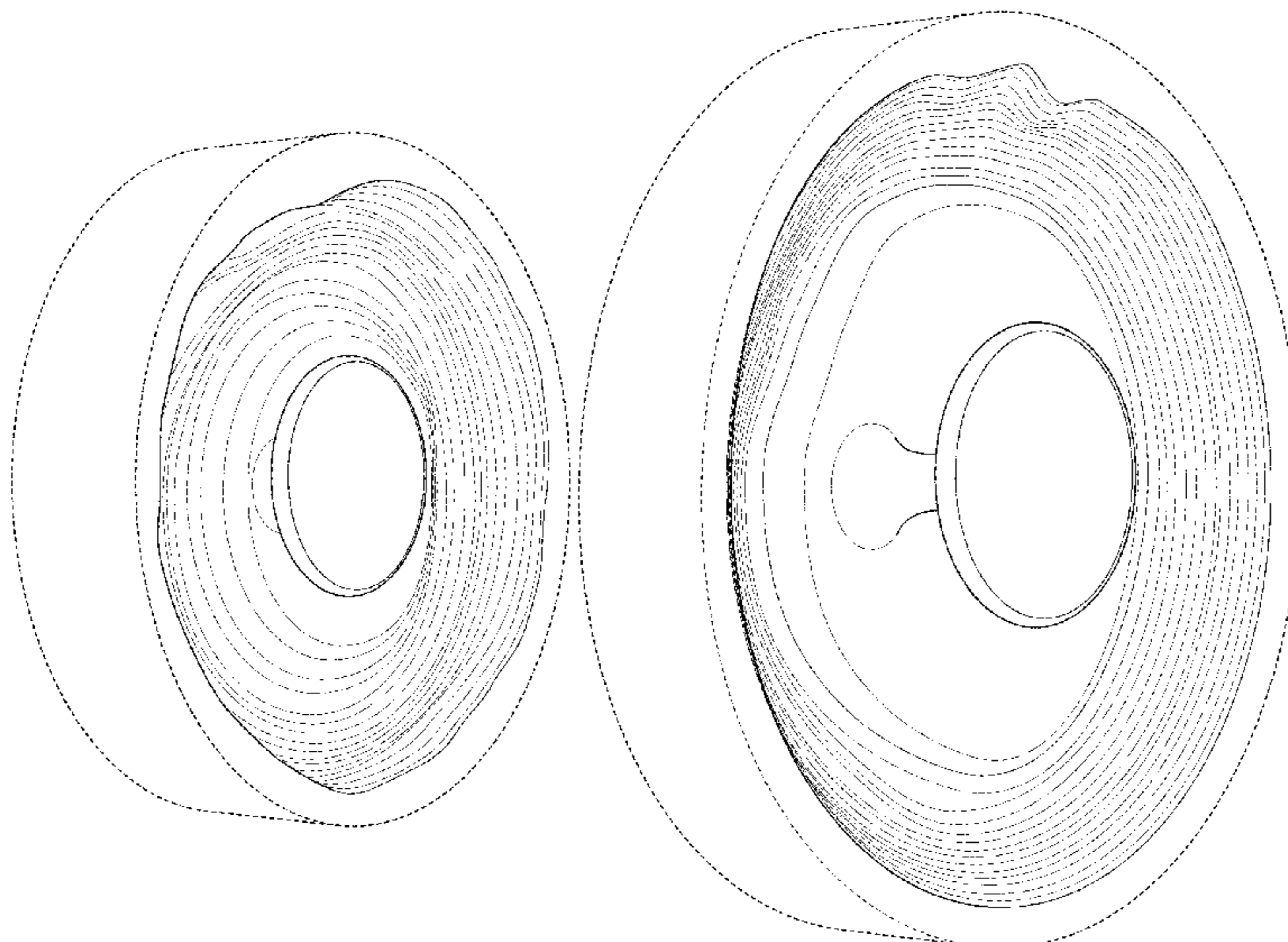

(56)

**References Cited**

U.S. PATENT DOCUMENTS

D331,123	S	*	11/1992	Clayton	.....	D26/122
D509,016	S	*	8/2005	Benghozi	.....	D26/74
D572,402	S	*	7/2008	Nakabayashi	.....	D26/124
D583,984	S	*	12/2008	Takahashi	.....	D26/89
D625,043	S	*	10/2010	Tessnow	.....	D26/124
D641,918	S	*	7/2011	Reo	.....	D26/118
D667,985	S	*	9/2012	Gielen	.....	D26/89
D674,962	S	*	1/2013	Drake	.....	D26/118
D699,387	S	*	2/2014	Snell	.....	D26/124
D705,473	S	*	5/2014	Messisaen	.....	D26/74
D723,210	S	*	2/2015	Highbridge	.....	D26/89
D773,102	S	*	11/2016	Meise	.....	D26/89
D807,562	S	*	1/2018	Amato	.....	D26/88
D809,180	S	*	1/2018	Oh	.....	D26/86
D841,868	S	*	2/2019	Xu	.....	D26/89

OTHER PUBLICATIONS

Polished Chrome Wall Sconce No. E20024-PC by ET2 Lighting.  
Available at build.com, visited Feb. 3, 2020. (Year: 2020).\*

Silver Leaf Wall Sconce No. WS-30624-SL by Modern Forms.  
Available at build.com, visited Feb. 3, 2020. (Year: 2020).\*

Brushed Nickel Wall Sconce No. WS-98812-BN by Modern Forms.  
Available at build.com, visited Feb. 3, 2020. (Year: 2020).\*

\* cited by examiner

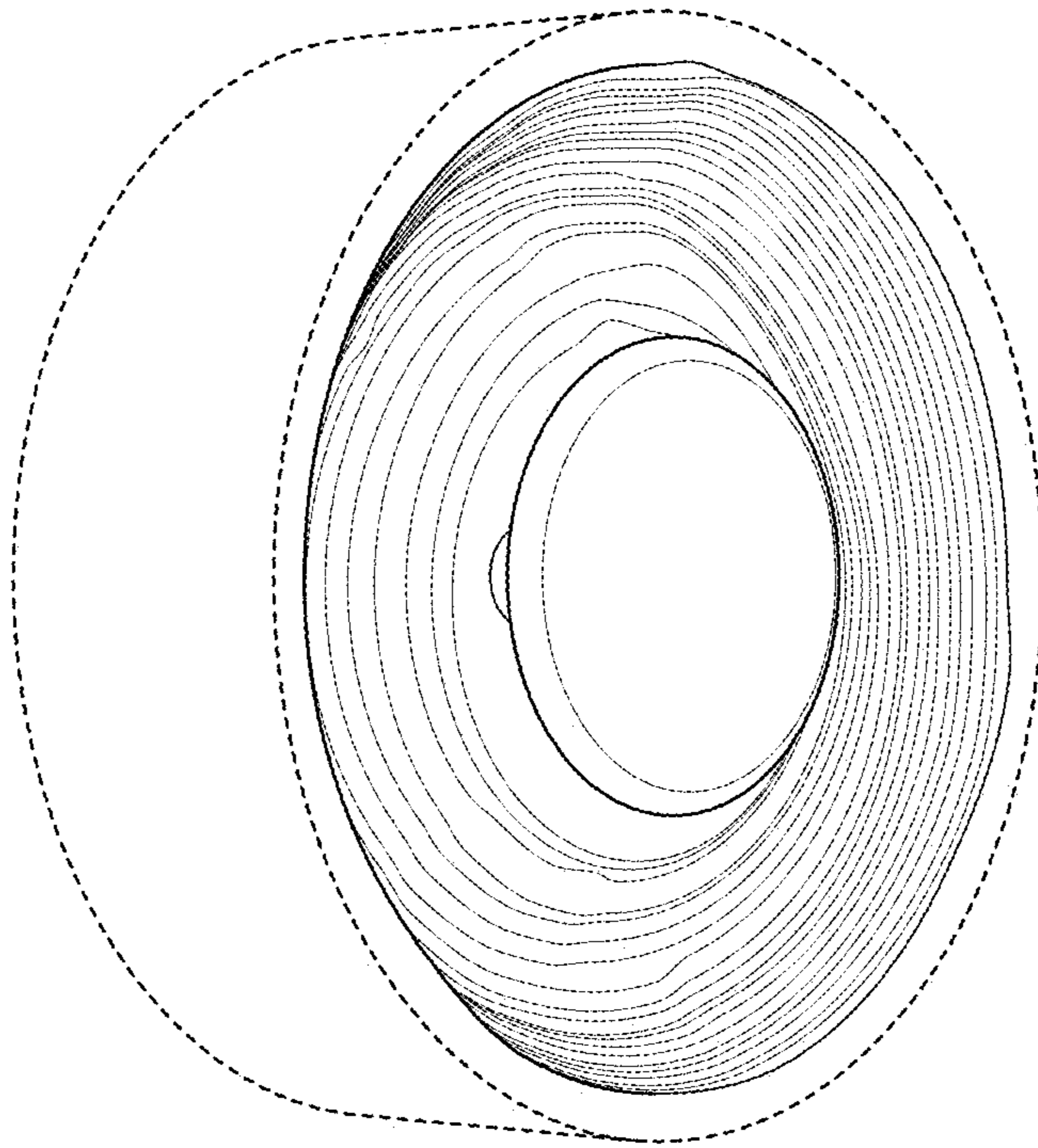

FIG. 1

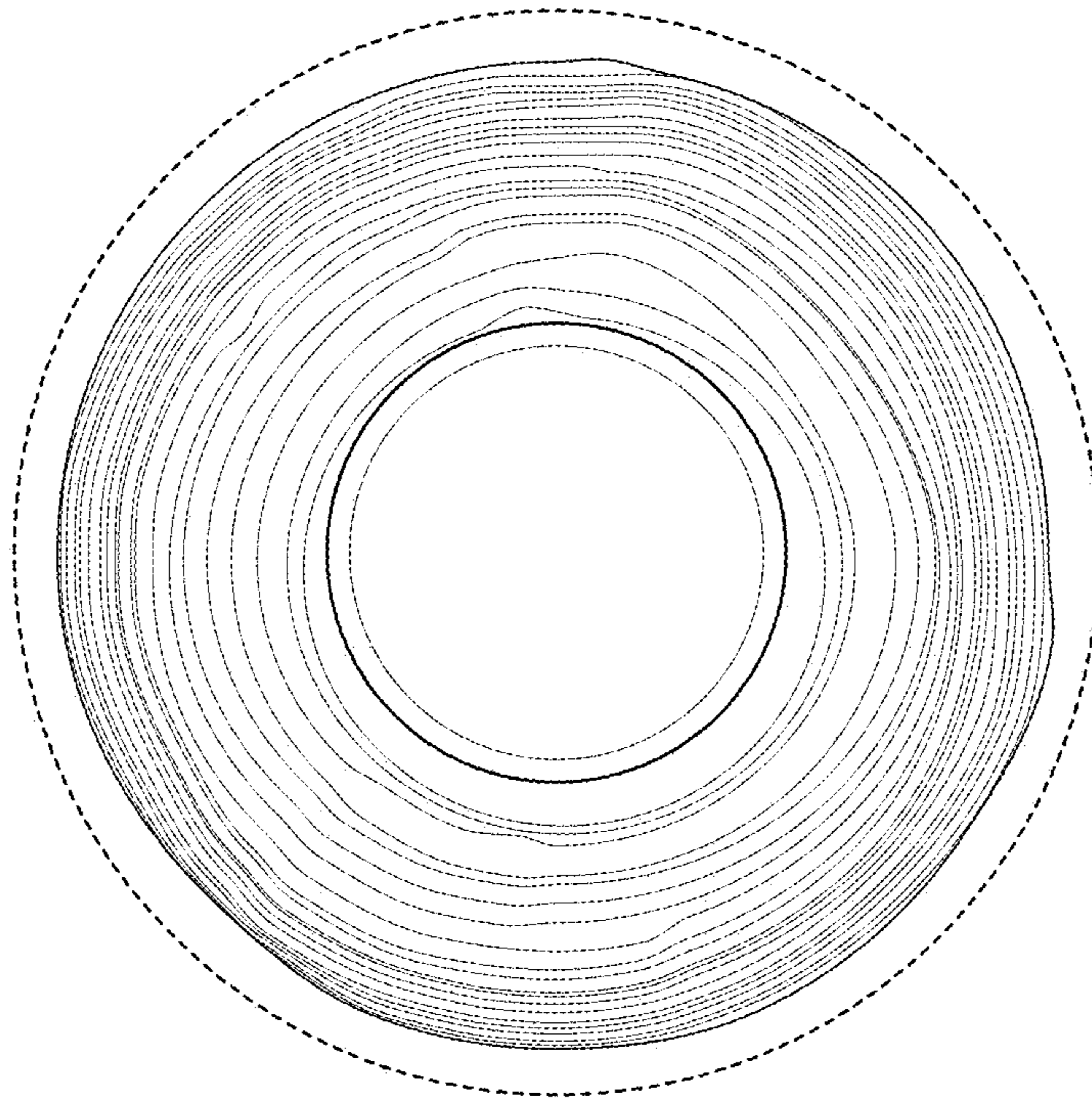

FIG. 2

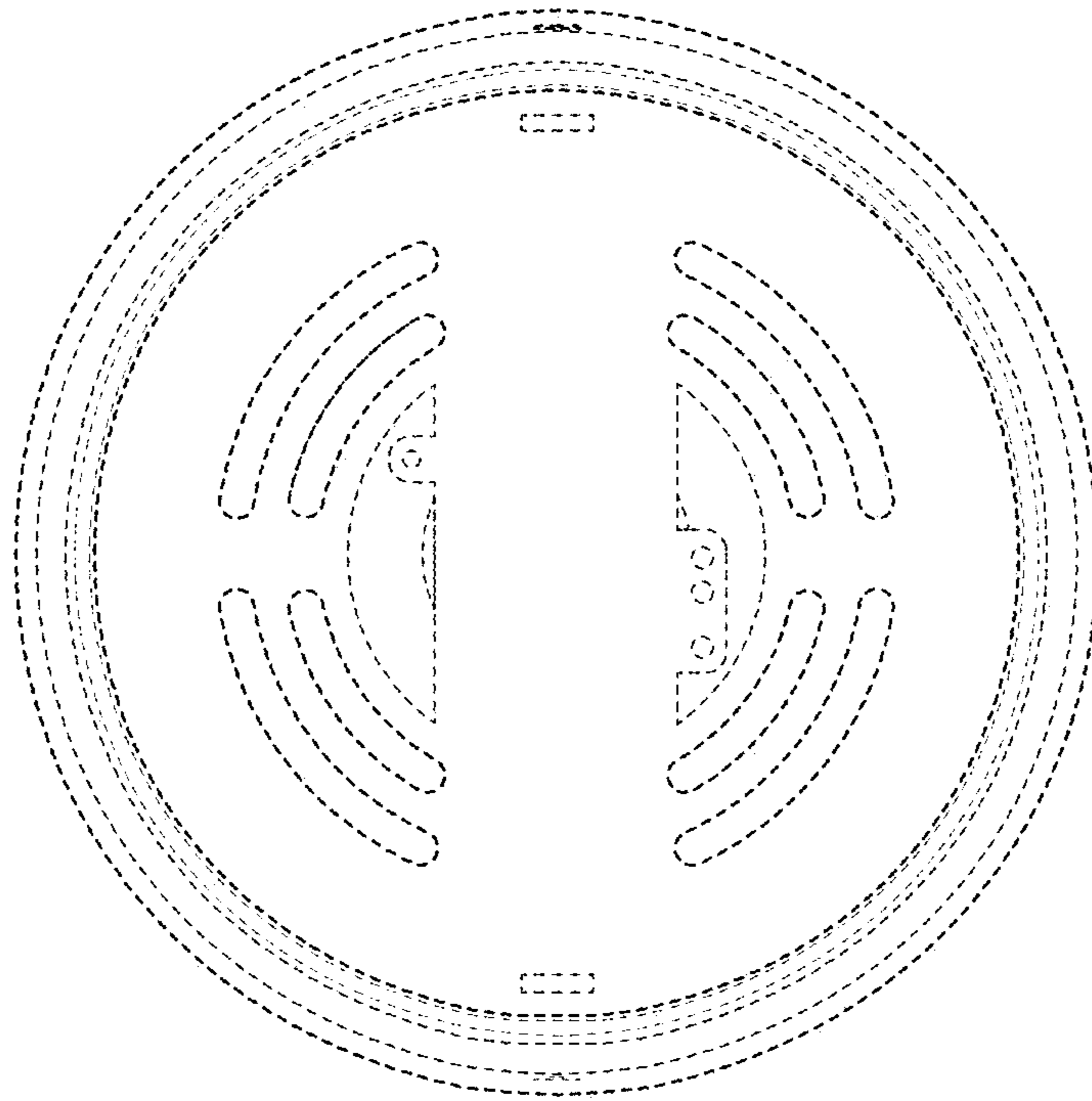

FIG. 3

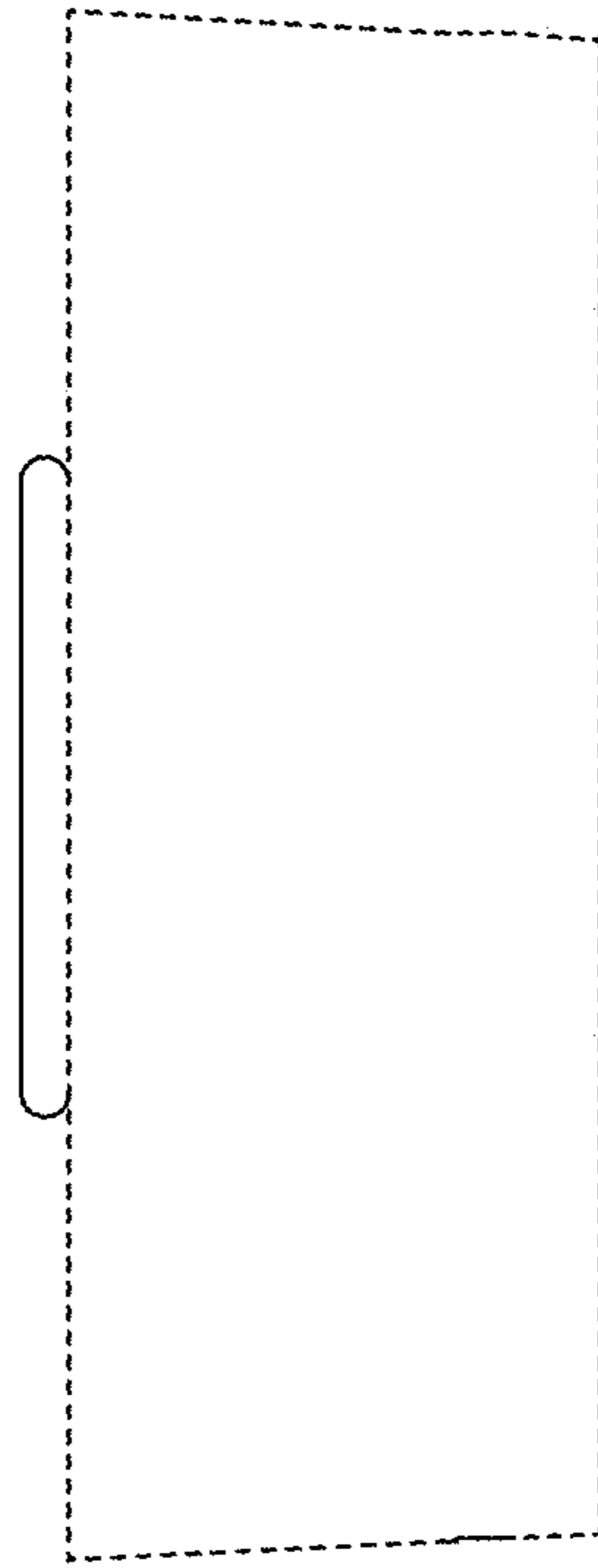

FIG. 4

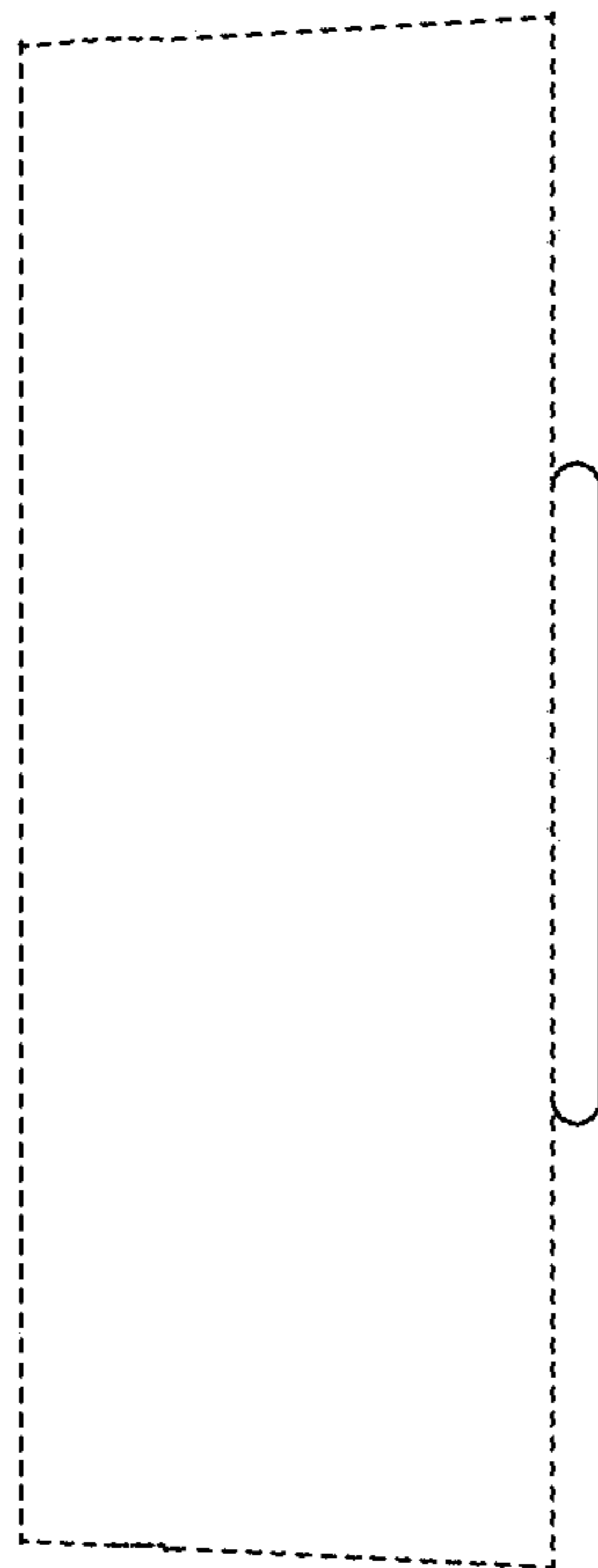

FIG. 5

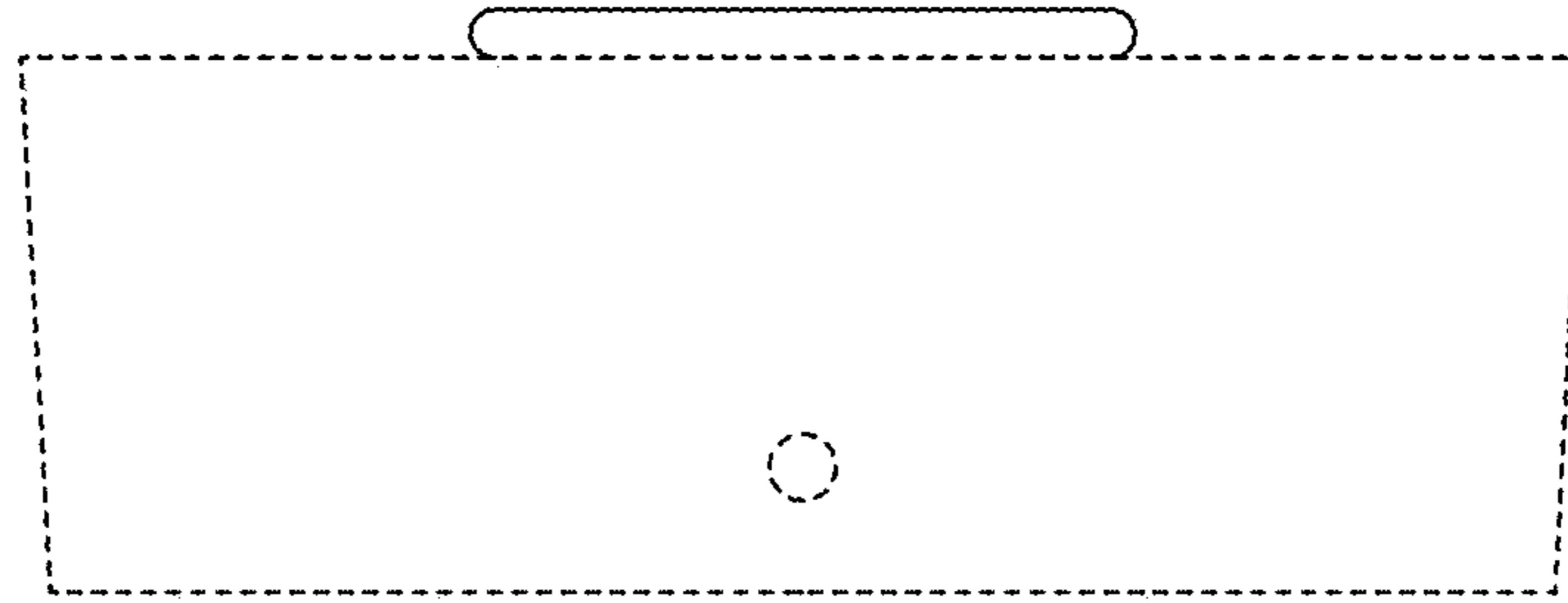

FIG. 6

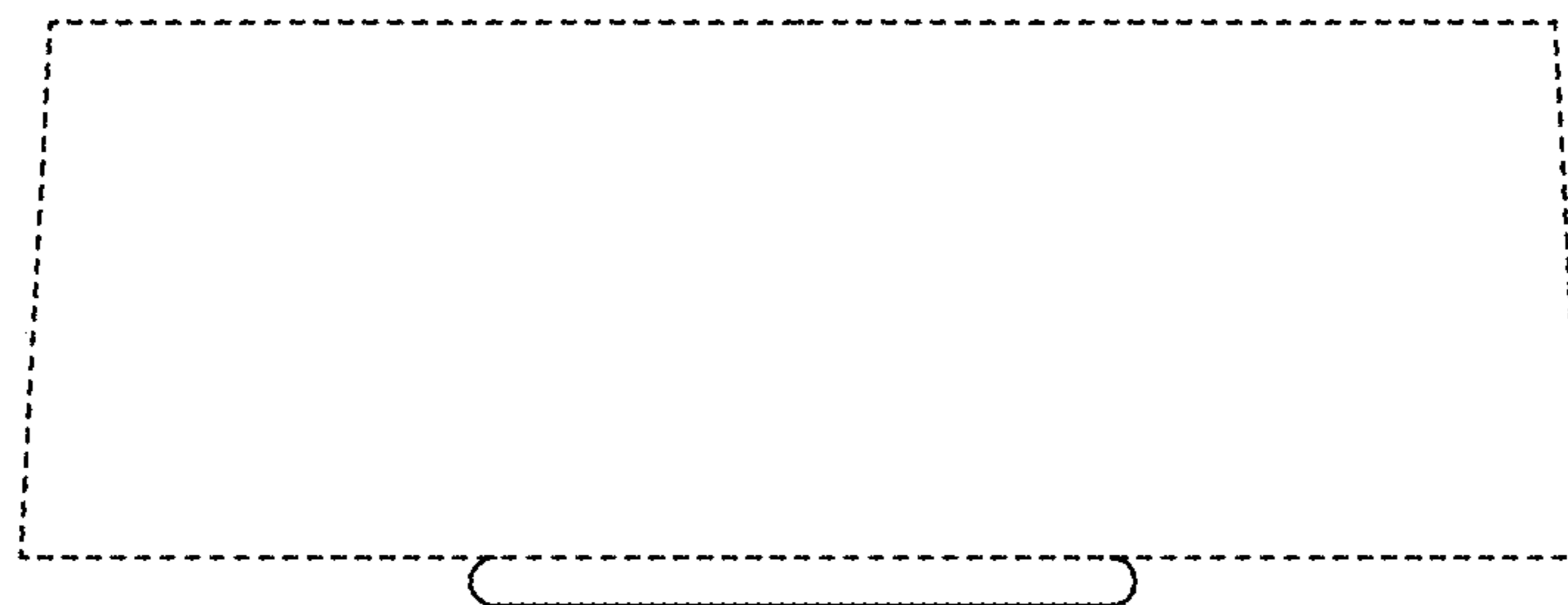

FIG. 7

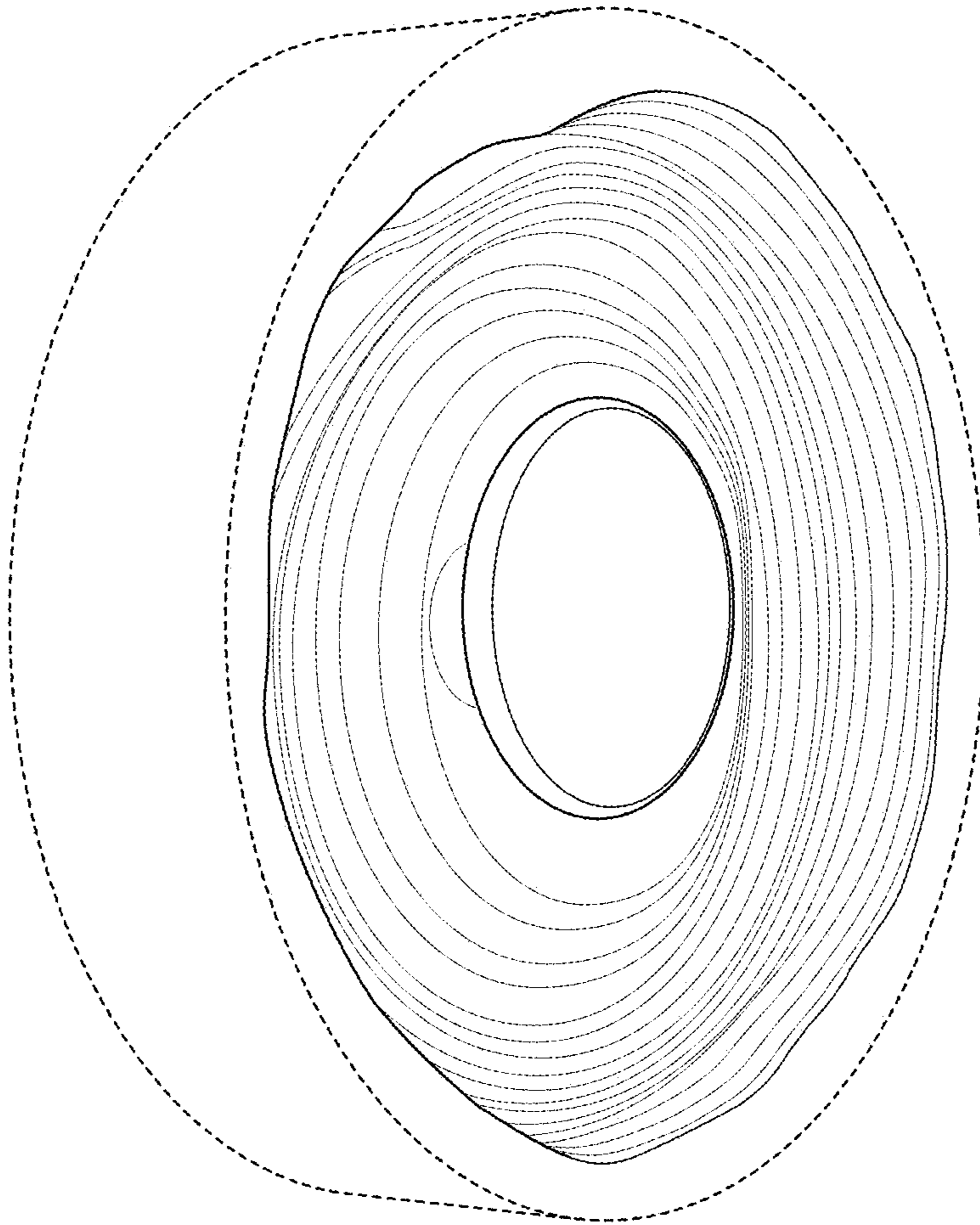

FIG. 8





FIG. 9

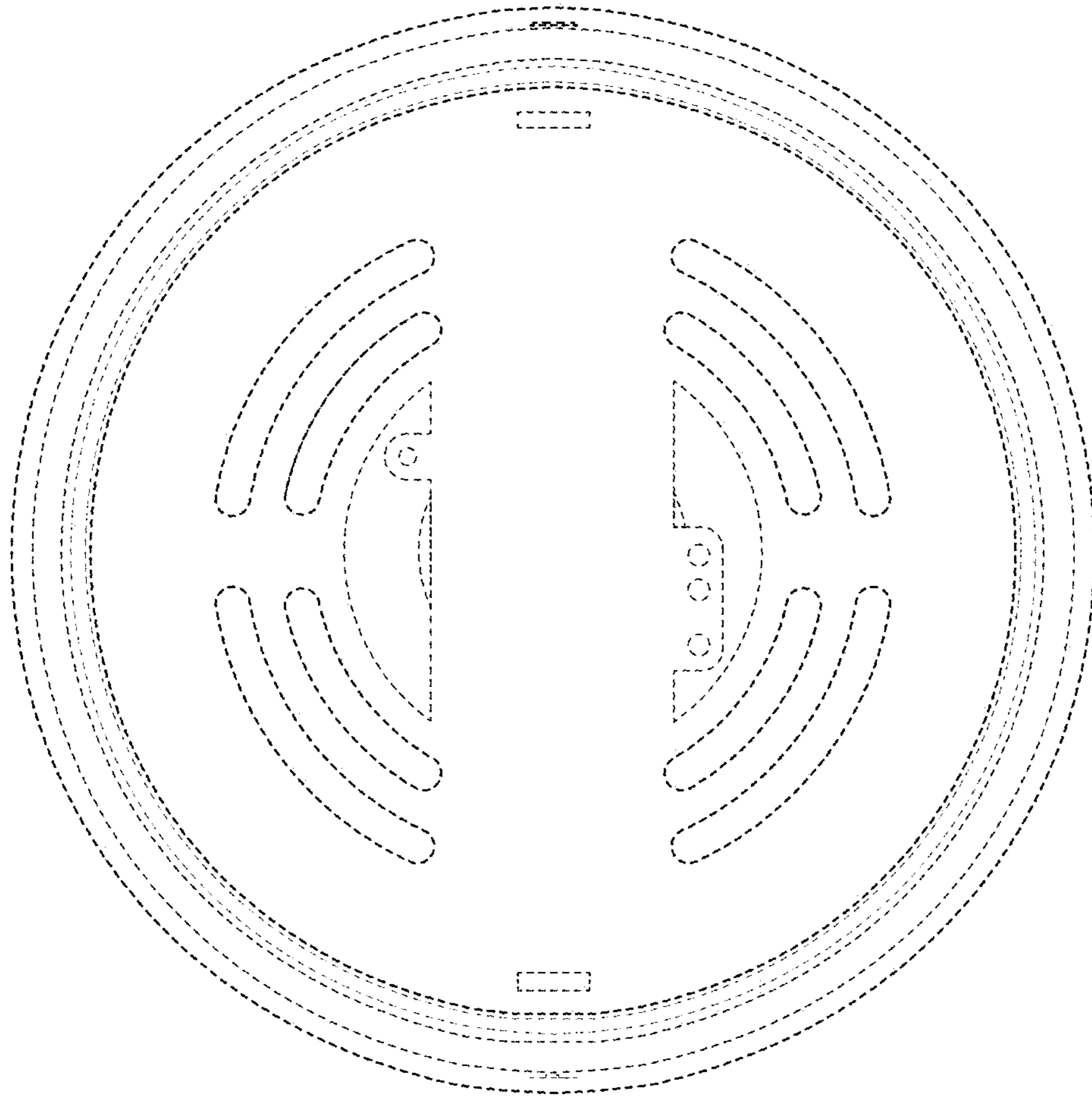

FIG. 10

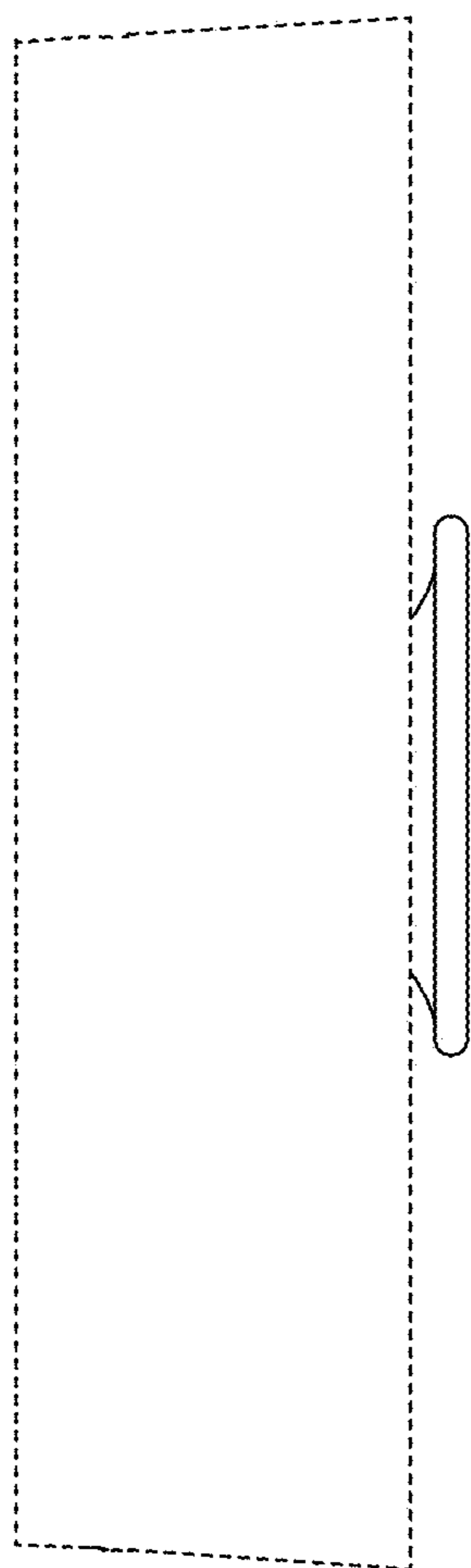

FIG. 11

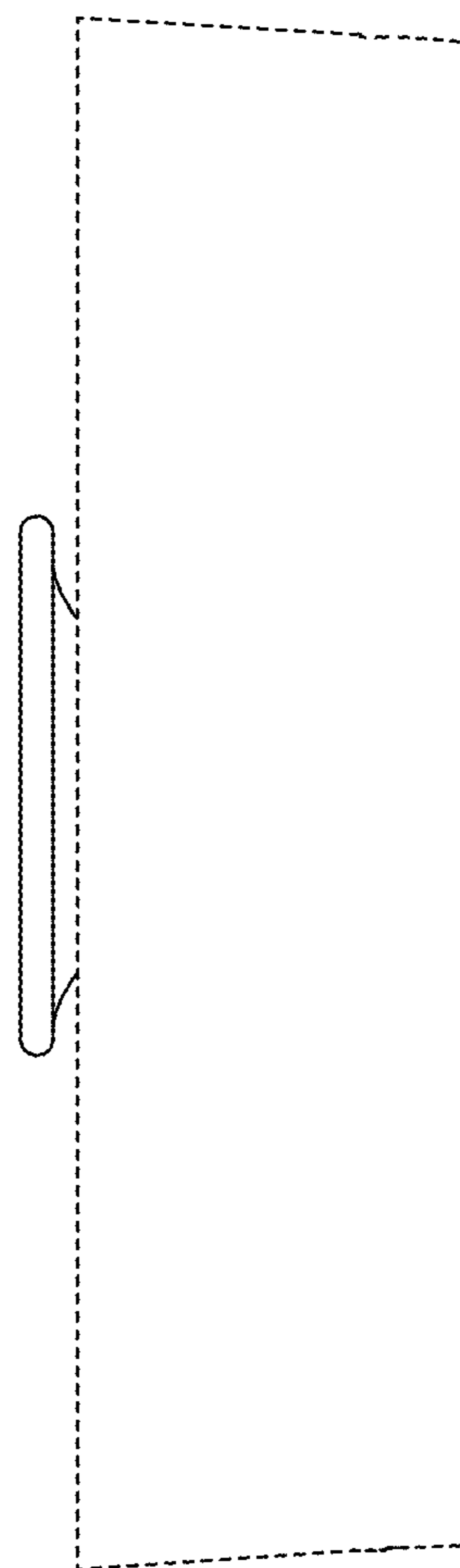

FIG. 12

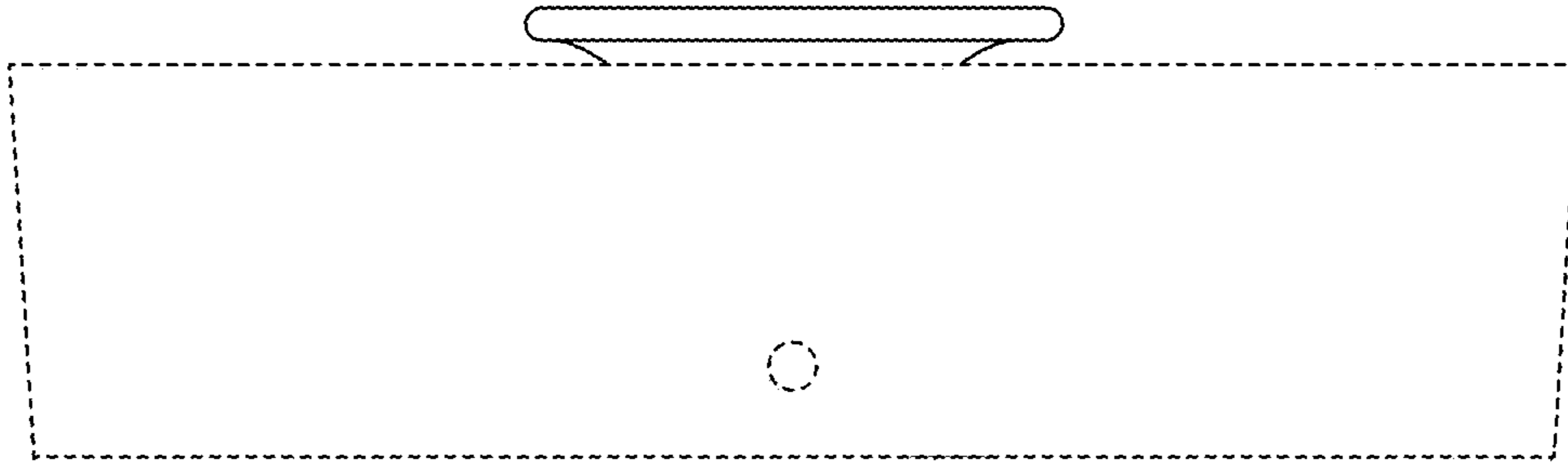

FIG. 13

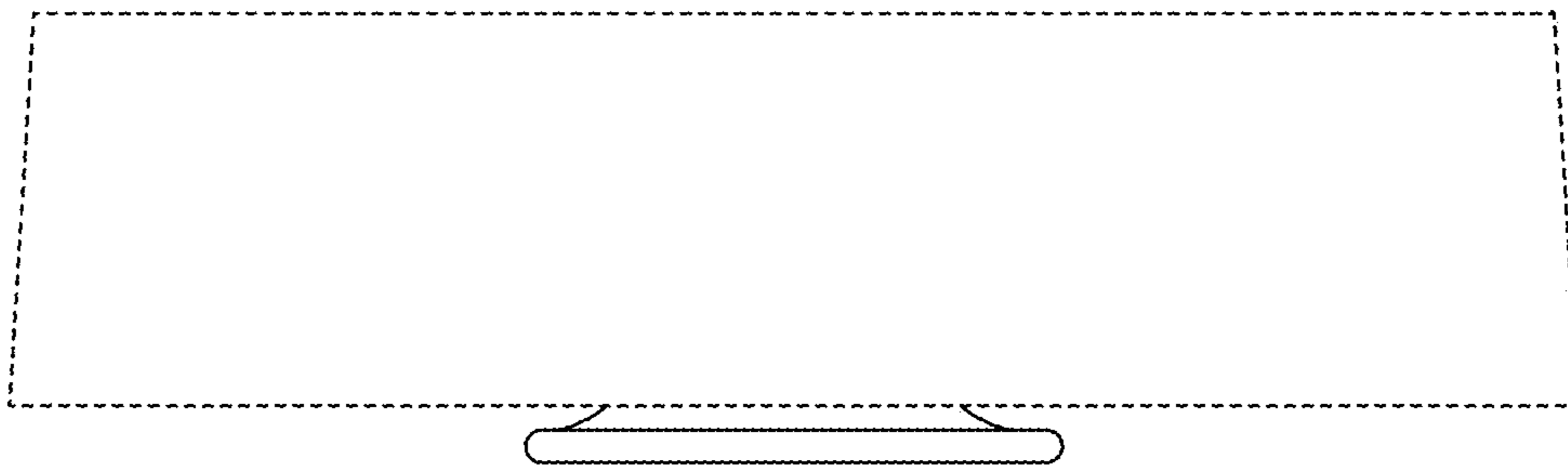

FIG. 14

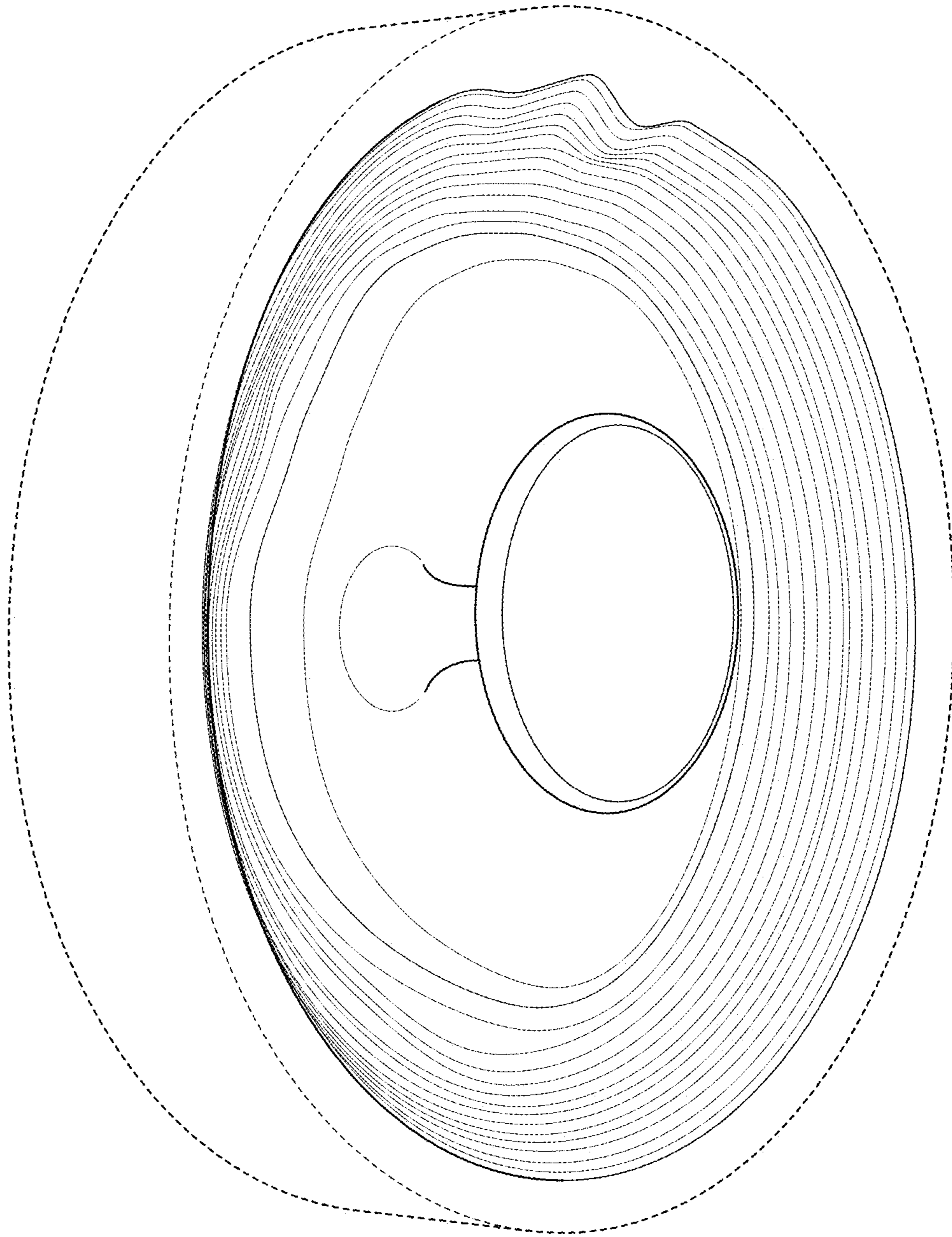

FIG. 15

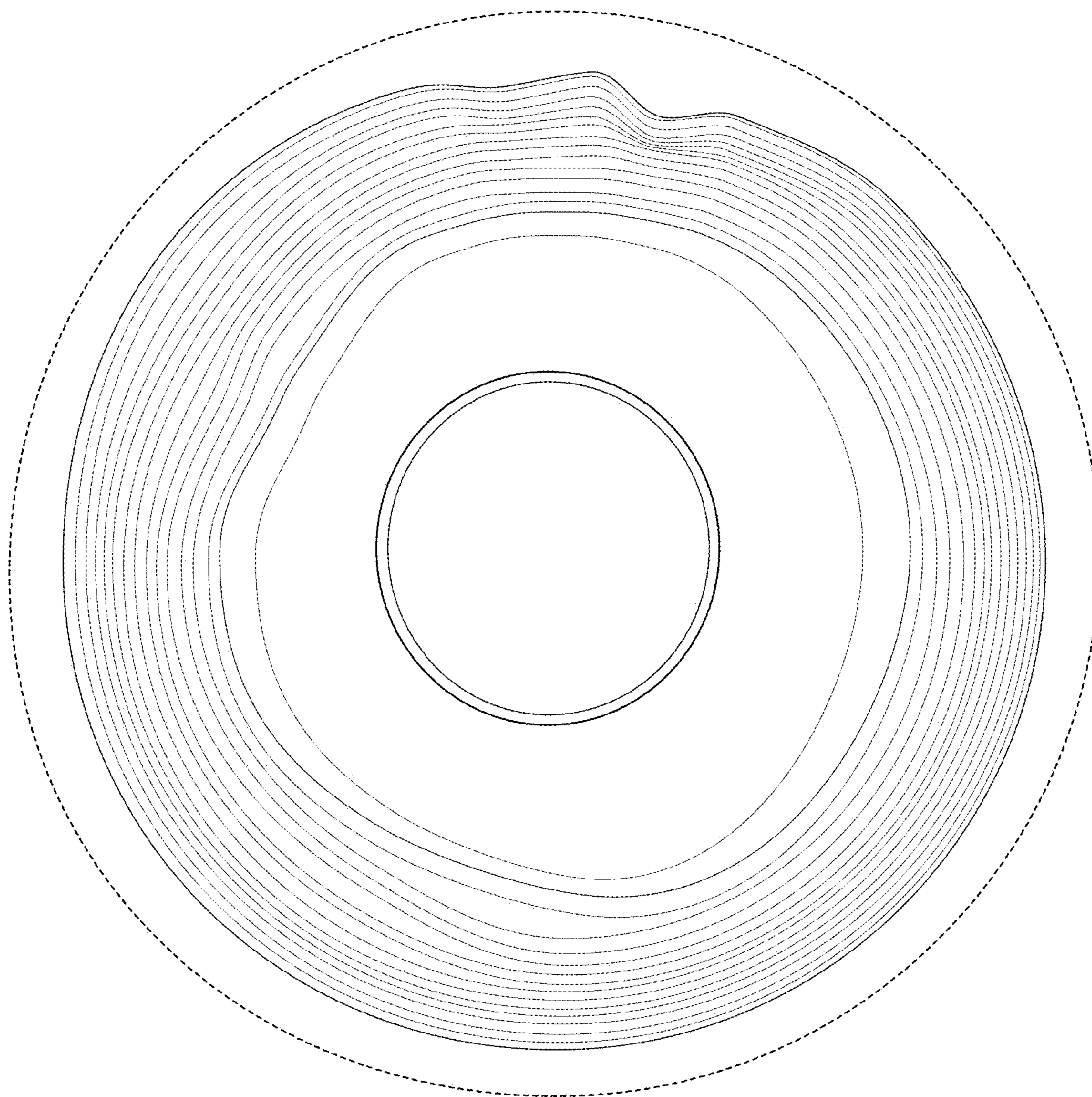

FIG. 16

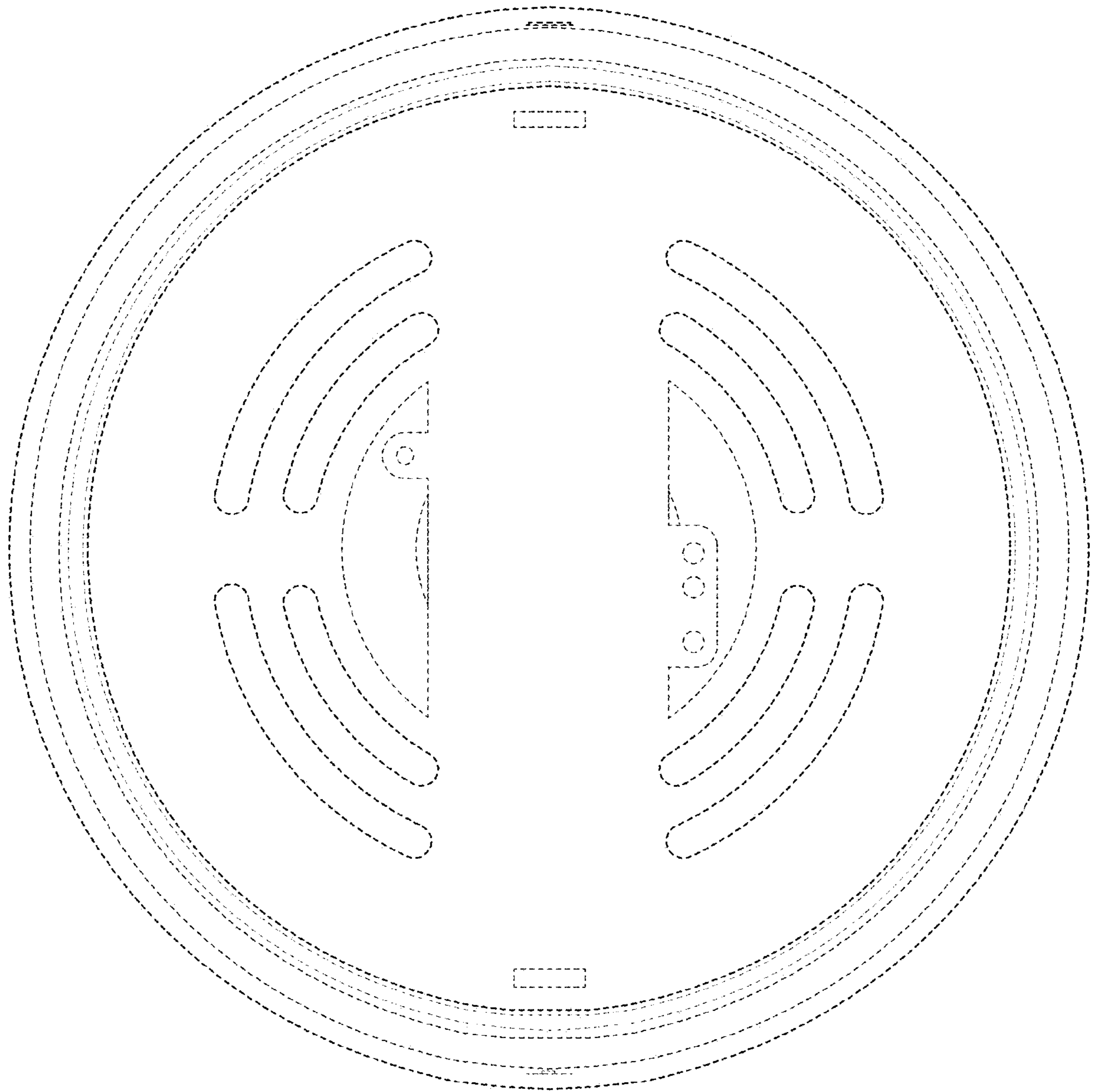

FIG. 17

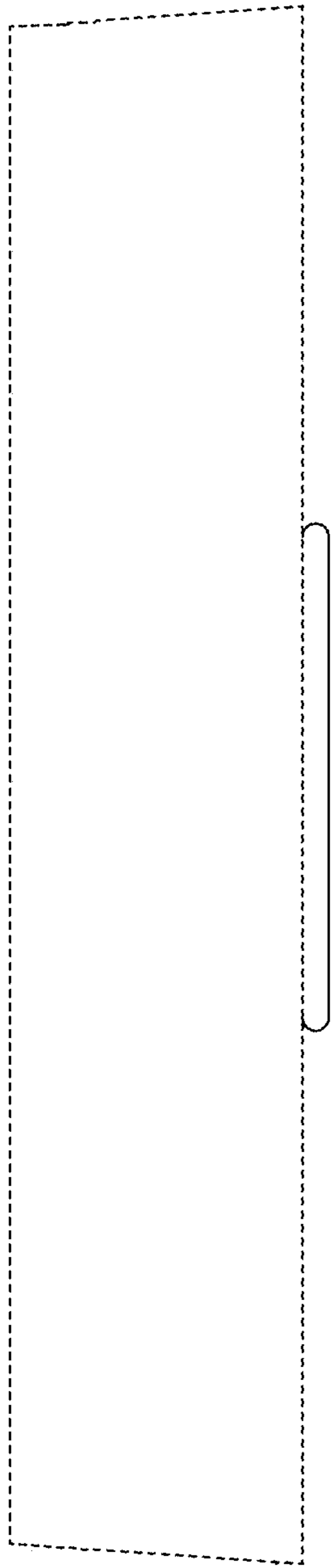

FIG. 18

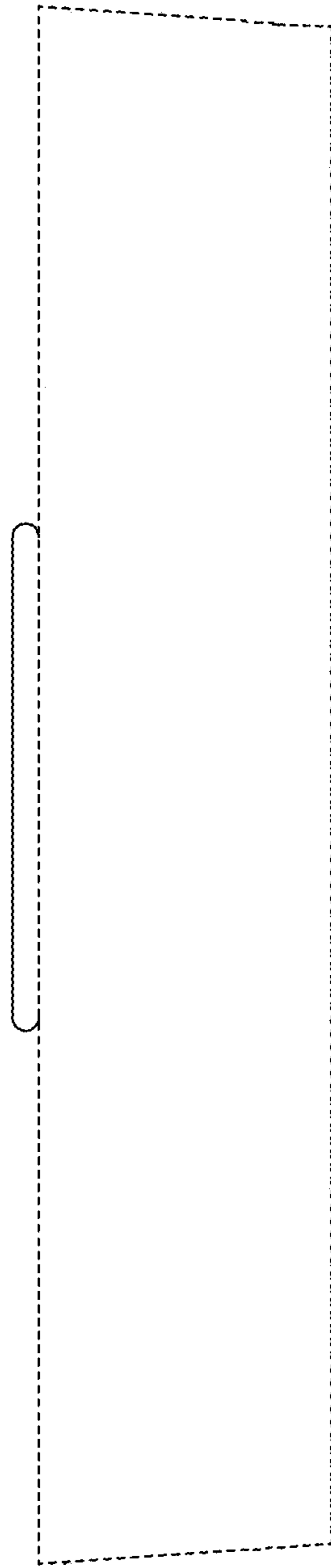

FIG. 19



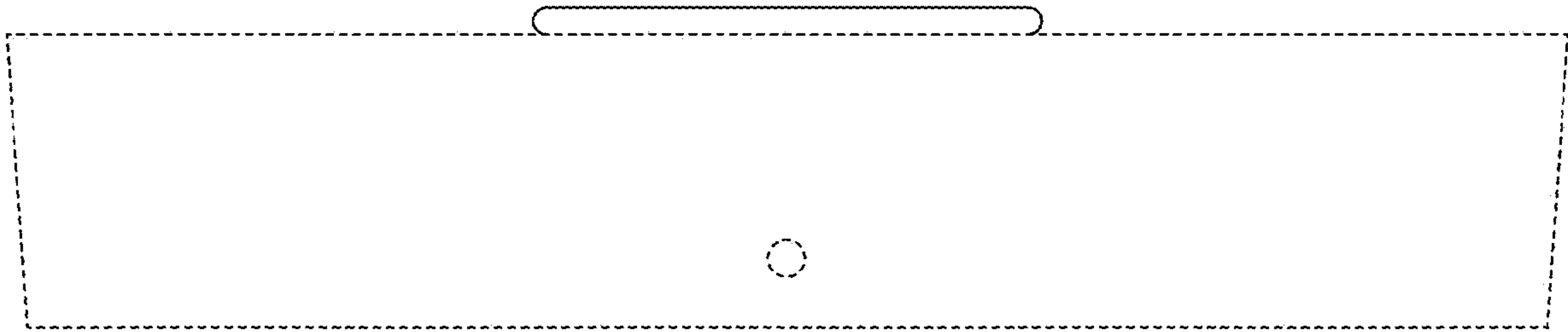

FIG. 20

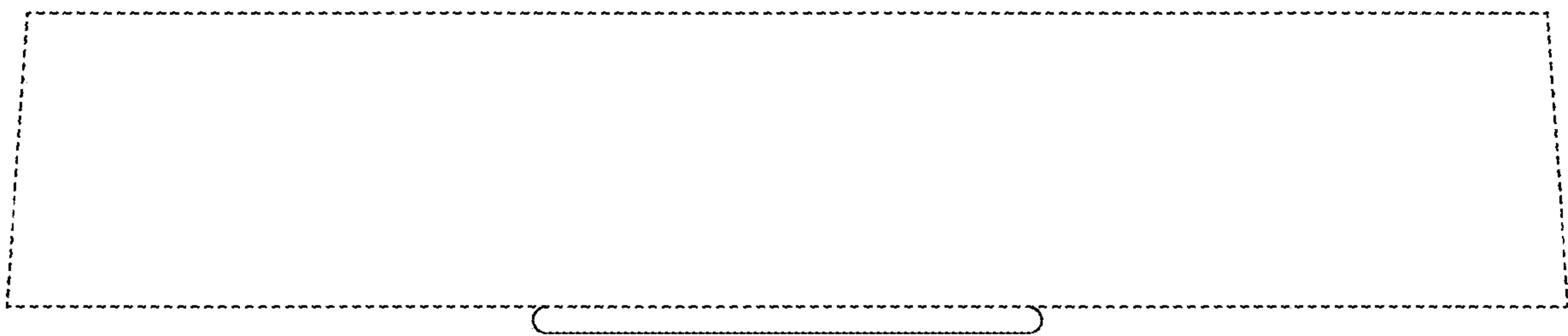

FIG. 21