



US00D888175S

(12) **United States Design Patent** (10) **Patent No.:** **US D888,175 S**  
**Doerksen et al.** (45) **Date of Patent:** **\*\* Jun. 23, 2020**

(54) **ELECTRIC VEHICLE FRONT**

FOREIGN PATENT DOCUMENTS

(71) Applicant: **Future Motion, Inc.**, Santa Cruz, CA (US)

TW 450823 B 8/2001  
WO 2009071879 A9 6/2009

(72) Inventors: **Kyle Jonathan Doerksen**, Santa Cruz, CA (US); **Beau Robertson**, Santa Cruz, CA (US)

OTHER PUBLICATIONS

Ben Smither, "Balancing Scooter / Skateboard", video, retrieved Sep. 22, 2016 from <https://www.youtube.com/watch?v=HGbbag9dkIU>, uploaded to YouTube on Mar. 4, 2007.

(73) Assignee: **Future Motion, Inc.**, Santa Cruz, CA (US)

(Continued)

(\*\*) Term: **15 Years**

*Primary Examiner* — Cynthia M. Chin

(74) *Attorney, Agent, or Firm* — Kolitch Romano LLP

(21) Appl. No.: **29/683,174**

(57) **CLAIM**

The ornamental design for an electric vehicle front, as shown and described.

(22) Filed: **Mar. 11, 2019**

(51) **LOC (12) Cl.** ..... **21-02**

(52) **U.S. Cl.**  
USPC ..... **D21/771**

**DESCRIPTION**

(58) **Field of Classification Search**  
USPC ..... D21/419, 421, 423, 426, 760, 763, 765, D21/766, 769, 771, 776, 803; D12/1  
CPC ..... A63C 17/01; A63C 17/12; A63C 2203/00; A63C 2203/011; A63C 2203/012; A63C 2203/013; A63C 2203/40; A63C 2203/52; B62D 51/02; B62K 2202/00; B62K 2207/00; B62K 2207/02; B62K 2207/04  
See application file for complete search history.

FIG. 1 is a bottom, front, and left side perspective view of our new design for an electric vehicle front, showing an illustration of use on an electric vehicle;  
FIG. 2 is another bottom, front, and left side perspective view thereof, with the exemplary electric vehicle removed for clarity of details;  
FIG. 3 is a top, rear, and right side perspective view thereof;  
FIG. 4 is a front view thereof;  
FIG. 5 is a rear view thereof;  
FIG. 6 is a right side view thereof;  
FIG. 7 is a left side view thereof;  
FIG. 8 is a top view thereof; and,  
FIG. 9 is a bottom view thereof.

The broken lines shown in the drawings are for the purpose of illustrating environmental subject matter and portions of the article that form no part of the claimed design. The shading lines shown in the drawings represent the approximate three-dimensional contour of the design, and are not intended to indicate surface decoration.

(56) **References Cited**

U.S. PATENT DOCUMENTS

1,585,258 A	5/1926	Moore
4,023,864 A	5/1977	Lang et al.
4,106,786 A	8/1978	Talbott
4,109,741 A	8/1978	Gabriel
4,997,196 A	3/1991	Wood
5,119,277 A	6/1992	Copley et al.
5,119,279 A	6/1992	Makowsky
5,132,883 A	7/1992	La Lumandier

(Continued)

**1 Claim, 9 Drawing Sheets**

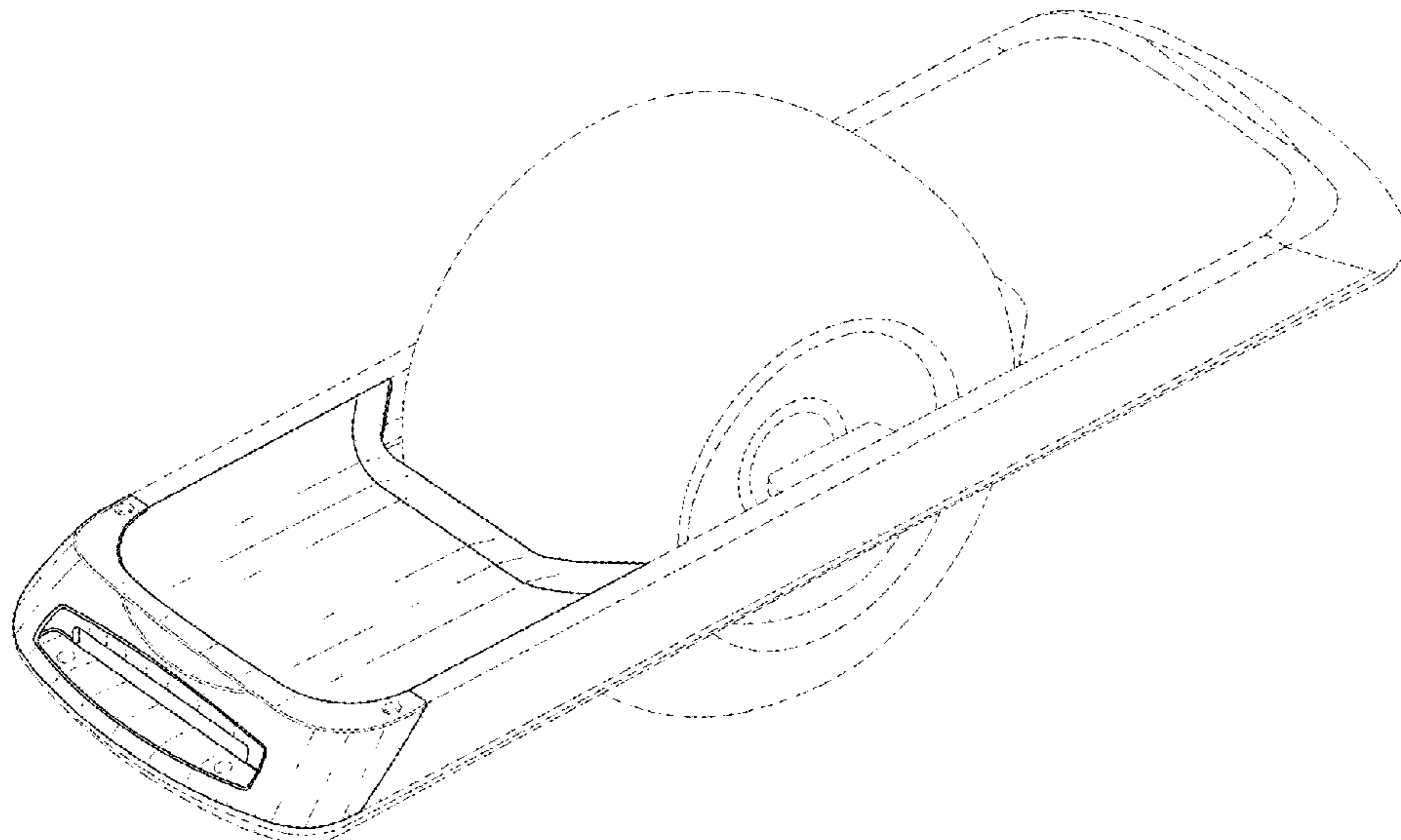

(56)

References Cited

U.S. PATENT DOCUMENTS

5,487,441 A 1/1996 Endo et al.  
 5,513,080 A 4/1996 Magle et al.  
 5,794,730 A 8/1998 Kamen  
 6,050,357 A 8/2000 Staelin et al.  
 6,223,104 B1 4/2001 Kamen et al.  
 6,242,701 B1 6/2001 Breed et al.  
 6,288,505 B1 9/2001 Heinzmann et al.  
 6,332,103 B1 12/2001 Steenson, Jr. et al.  
 6,408,240 B1 6/2002 Morrell et al.  
 6,536,788 B1 3/2003 Kuncz et al.  
 6,538,411 B1 3/2003 Field et al.  
 6,553,271 B1 4/2003 Morrell  
 6,561,294 B1 5/2003 Kamen et al.  
 6,779,621 B2 8/2004 Kamen et al.  
 6,789,640 B1 9/2004 Arling et al.  
 6,827,163 B2 12/2004 Amsbury et al.  
 6,874,591 B2 4/2005 Morrell et al.  
 6,965,206 B2 11/2005 Kamen et al.  
 6,992,452 B1 1/2006 Sachs et al.  
 7,023,330 B2 4/2006 Kamen et al.  
 7,053,289 B2 5/2006 Iwai et al.  
 7,090,040 B2 8/2006 Kamen et al.  
 7,091,724 B2 8/2006 Heinzmann et al.  
 7,130,702 B2 10/2006 Morrell  
 7,138,774 B2 11/2006 Negoro et al.  
 7,157,875 B2 1/2007 Kamen et al.  
 7,172,044 B2 2/2007 Bouvet  
 7,198,280 B2 4/2007 Hara  
 7,263,453 B1 8/2007 Gansler et al.  
 D551,592 S 9/2007 Chang et al.  
 7,424,927 B2 9/2008 Hiramatsu  
 7,467,681 B2 12/2008 Hiramatsu  
 7,479,097 B2 1/2009 Rosborough et al.  
 7,740,099 B2 6/2010 Field et al.  
 7,757,794 B2 7/2010 Heinzmann et al.  
 7,789,174 B2 9/2010 Kamen et al.  
 7,811,217 B2 10/2010 Odien  
 7,857,088 B2 12/2010 Field et al.  
 7,900,725 B2 3/2011 Heinzmann et al.  
 7,962,256 B2 6/2011 Stevens et al.  
 7,963,352 B2 6/2011 Alexander  
 7,979,179 B2 7/2011 Gansler  
 8,052,293 B2 11/2011 Hurwitz  
 8,083,313 B2 12/2011 Karppinen et al.  
 8,146,696 B2 4/2012 Kaufman  
 8,170,780 B2 5/2012 Field et al.  
 8,467,941 B2 6/2013 Field et al.  
 8,490,723 B2 7/2013 Heinzmann et al.  
 8,562,386 B2 10/2013 Carlson et al.

8,682,487 B2 3/2014 Kurth et al.  
 9,101,817 B2 8/2015 Doerksen  
 D746,928 S 1/2016 Doerksen  
 9,452,345 B2\* 9/2016 Doerksen ..... A63C 17/12  
 D768,252 S 10/2016 Bigler  
 D769,997 S 10/2016 Doerksen  
 9,598,141 B1\* 3/2017 Doerksen ..... B62K 11/007  
 9,707,470 B2\* 7/2017 Ma ..... G05D 1/0891  
 D797,875 S\* 9/2017 Ma ..... D21/760  
 D802,693 S\* 11/2017 Lu ..... D21/765  
 9,908,580 B2\* 3/2018 Doerksen ..... B62K 11/007  
 D815,228 S\* 4/2018 Ma ..... D21/765  
 9,962,597 B2\* 5/2018 Doerksen ..... B62K 25/00  
 D821,517 S\* 6/2018 Doerksen ..... D21/765  
 D827,747 S\* 9/2018 Ma ..... D21/765  
 10,112,680 B2\* 10/2018 Doerksen ..... B60K 7/0007  
 10,144,478 B2\* 12/2018 Ying ..... G01L 5/225  
 D843,532 S\* 3/2019 Doerksen ..... D21/765  
 D850,552 S\* 6/2019 Doerksen ..... D21/765  
 10,369,453 B2\* 8/2019 Bigler ..... B60L 50/52  
 10,399,457 B2\* 9/2019 Doerksen ..... B62K 11/007  
 10,456,658 B1\* 10/2019 Doerksen ..... B60L 3/00  
 2005/0241864 A1 11/2005 Hiramatsu  
 2006/0038520 A1 2/2006 Negoro et al.  
 2006/0049595 A1 3/2006 Crigler et al.  
 2006/0170174 A1 8/2006 Hiramatsu  
 2006/0213711 A1 9/2006 Hara  
 2006/0260862 A1 11/2006 Nishikawa  
 2007/0194558 A1 8/2007 Stone et al.  
 2007/0254789 A1 11/2007 Odien  
 2011/0309772 A1 12/2011 Forgey  
 2012/0232734 A1 9/2012 Pelletier  
 2013/0081891 A1 4/2013 Ulmen et al.  
 2013/0175943 A1 7/2013 Tackett  
 2016/0121198 A1\* 5/2016 Doerksen ..... A63C 17/014  
 701/22  
 2017/0120139 A1\* 5/2017 Ma ..... A63C 17/014  
 2018/0072367 A1\* 3/2018 Li ..... B62K 11/007

OTHER PUBLICATIONS

www.electricunicycle.com, "Leviskate self-balancing one-wheel skateboard", video, retrieved Sep. 22, 2016 from <https://www.youtube.com/watch?v=462Jj1xSSqc>, uploaded to YouTube on Aug. 5, 2007.  
 John Xenon, "One wheel self balancing skateboard Ver2 Jan. 2009. #2", video, retrieved Sep. 22, 2016 from <https://www.youtube.com/watch?v=8RPFNUsuW78>, uploaded to YouTube on Jan. 3, 2009.  
 Rodger Cleye, "Leviskate (Balancing Skateboard) in Operation", video, retrieved Sep. 22, 2016 from [https://www.youtube.com/watch?v=eN2J8m\\_E0go](https://www.youtube.com/watch?v=eN2J8m_E0go), uploaded to YouTube on Apr. 18, 2013.

\* cited by examiner

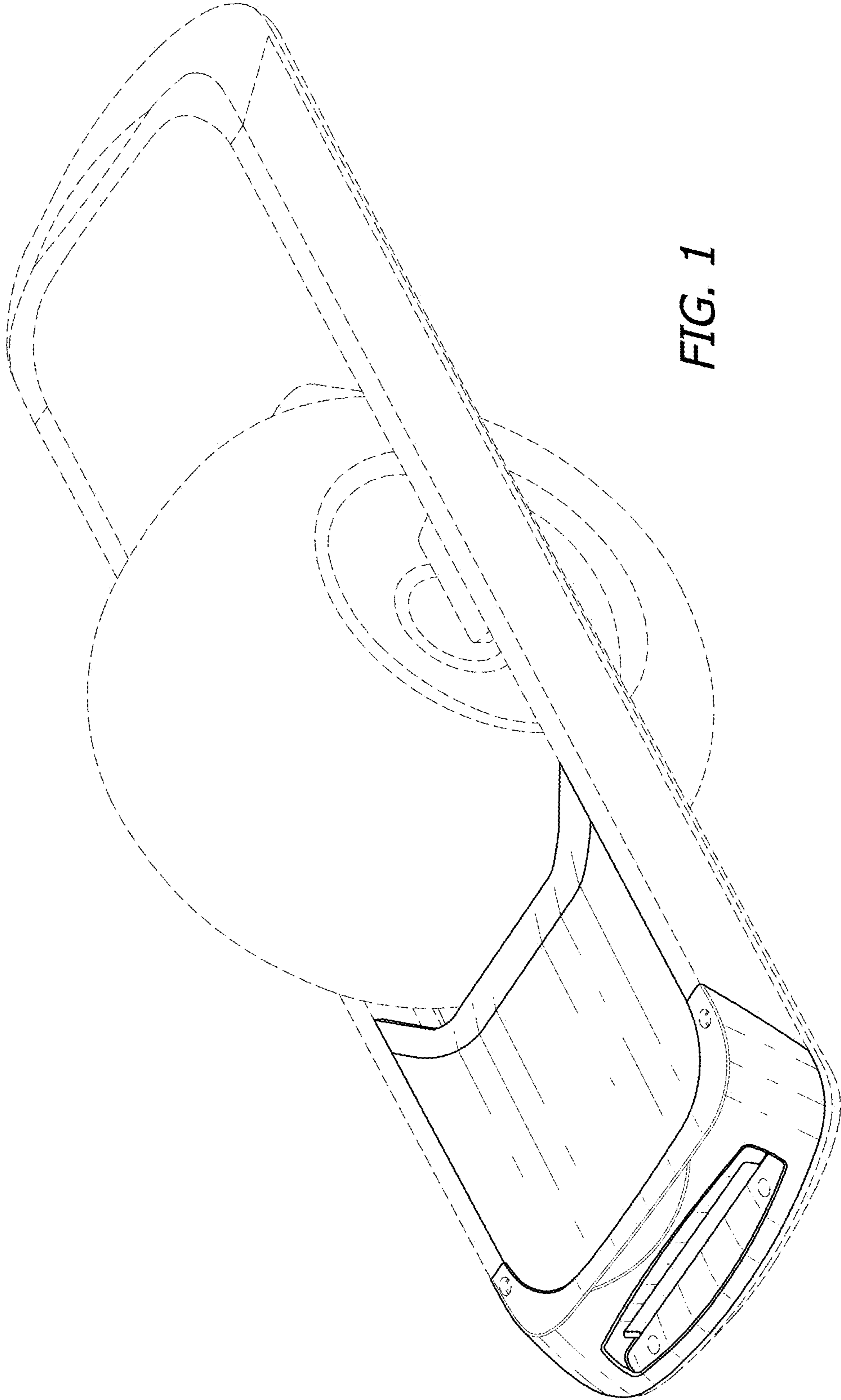

FIG. 1

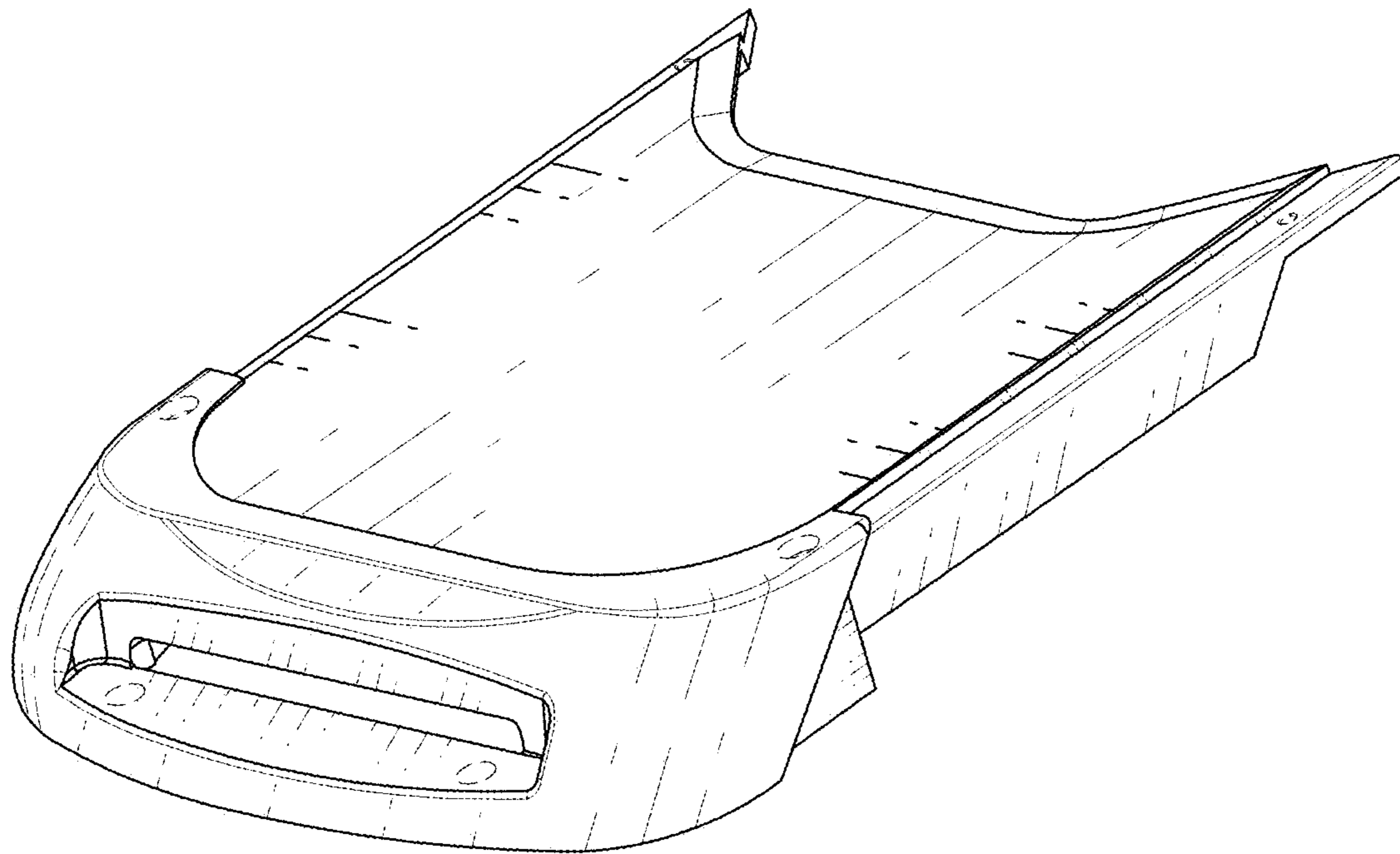

FIG. 2

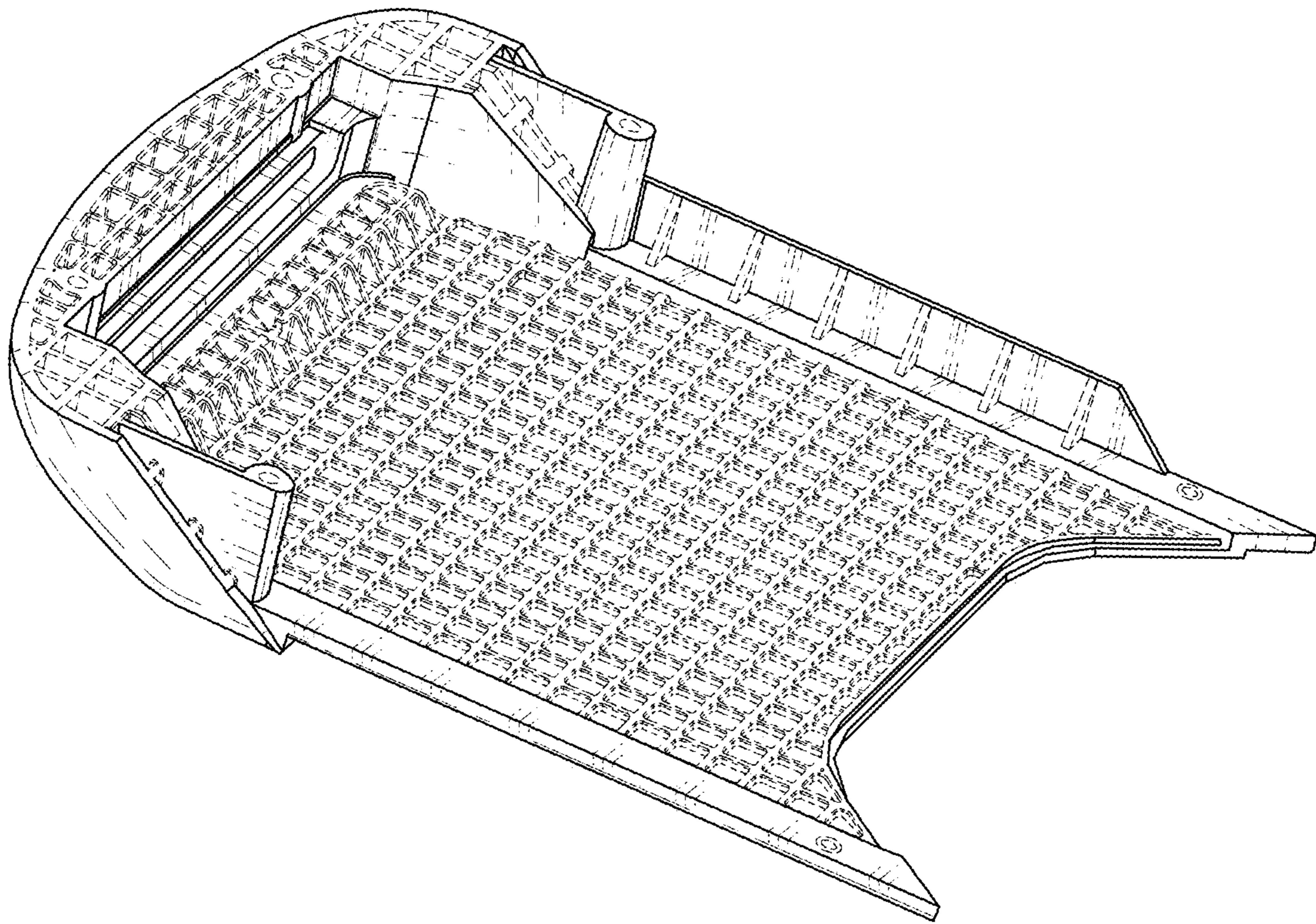

FIG. 3

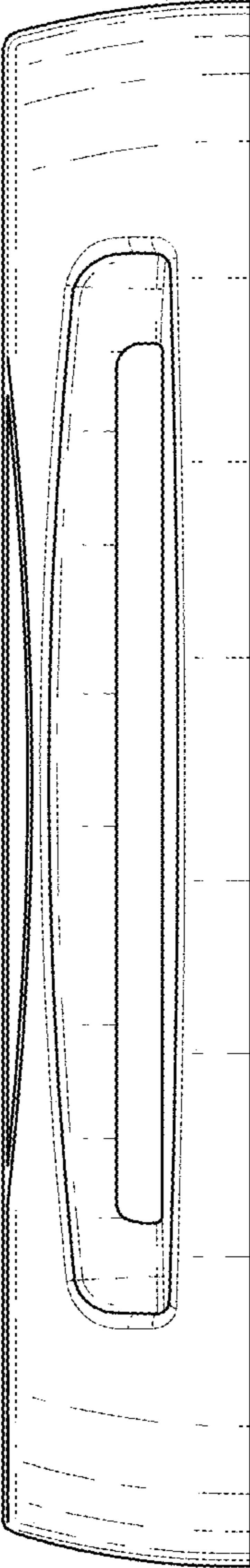

FIG. 4

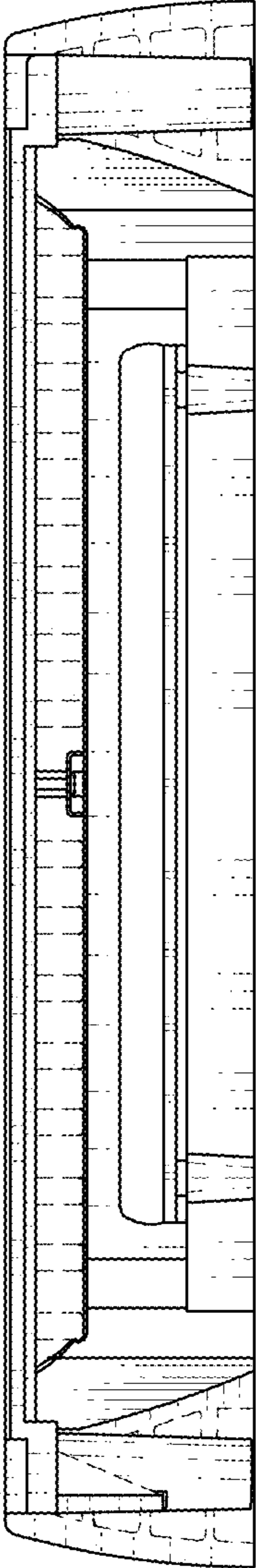

FIG. 5

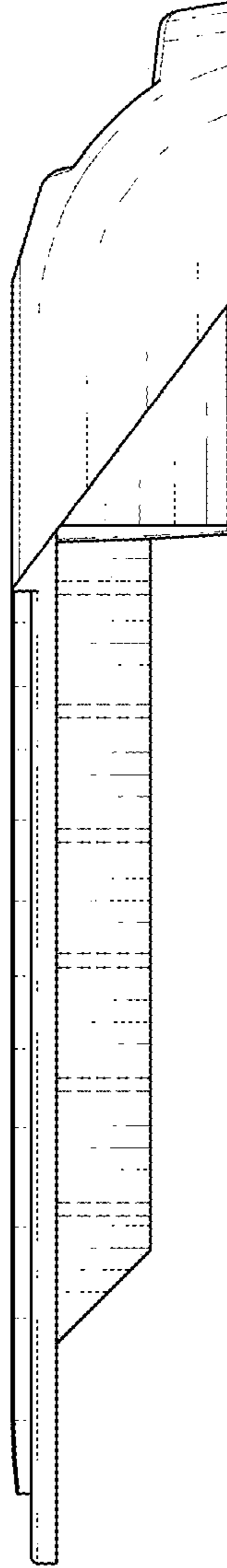

FIG. 6



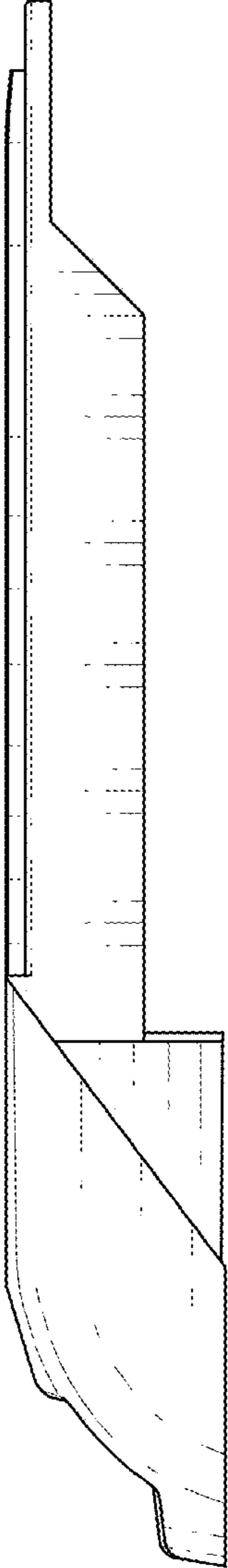
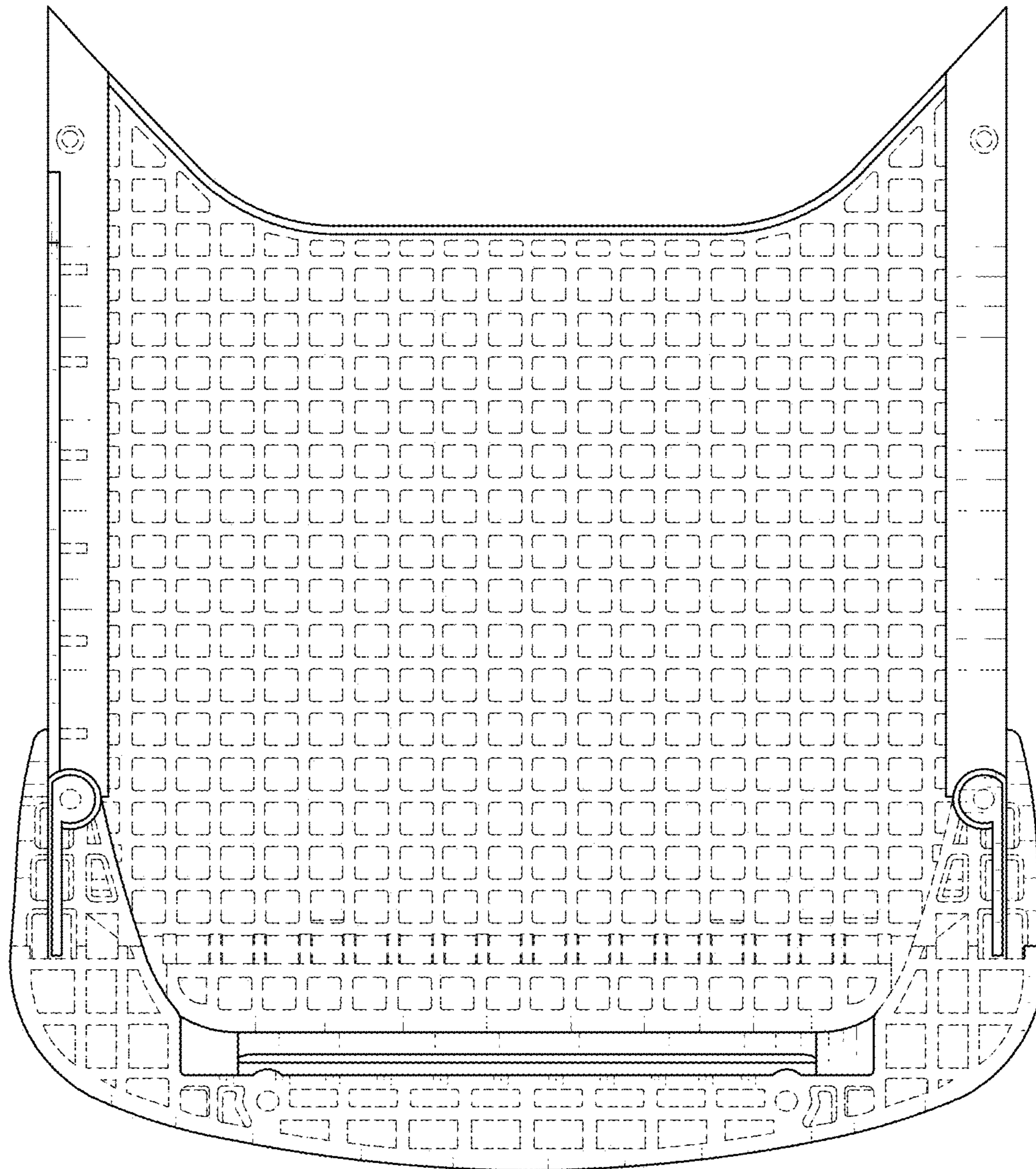

FIG. 7



*FIG. 8*

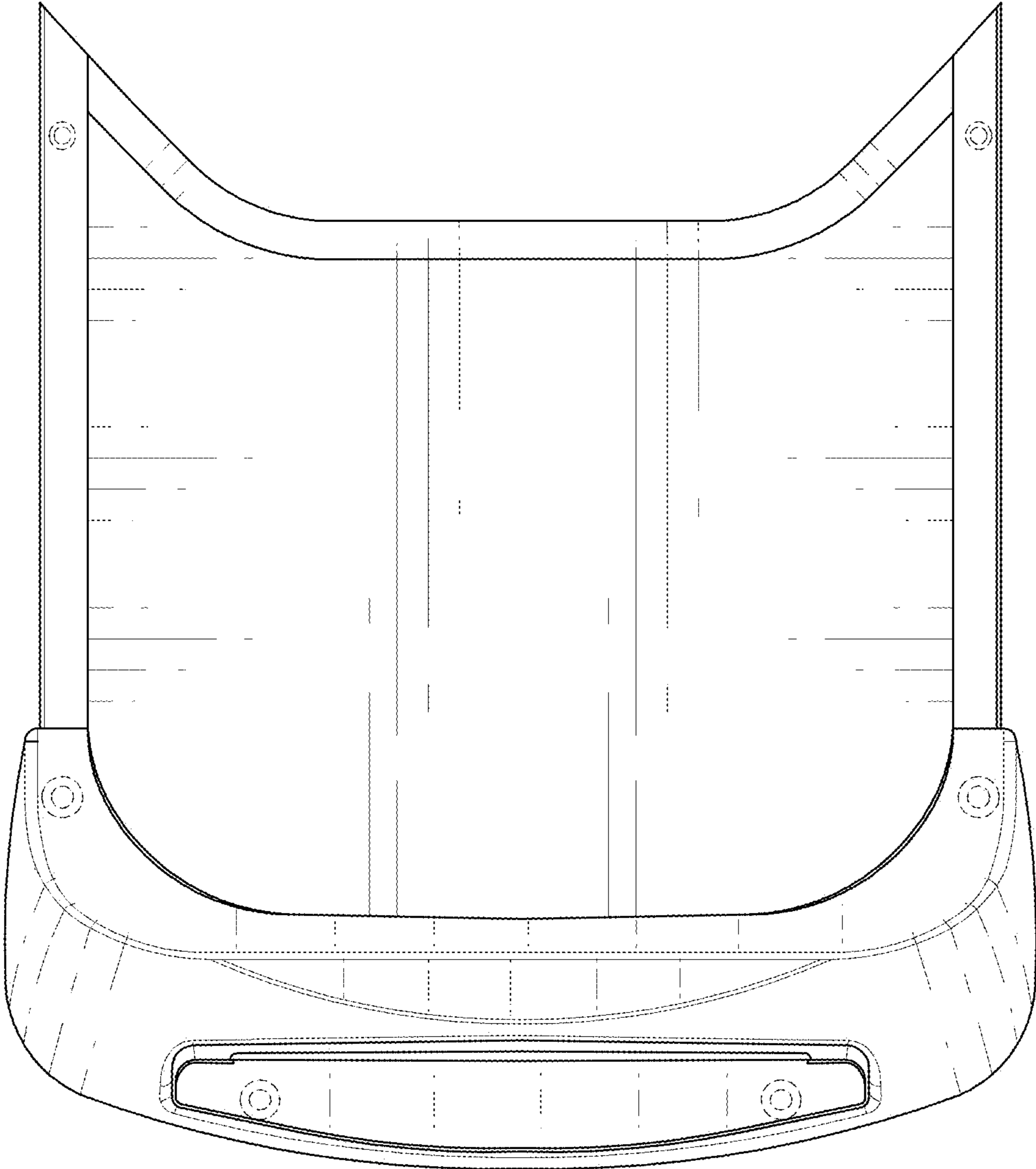

FIG. 9