



US00D888159S

(12) **United States Design Patent** (10) **Patent No.:** **US D888,159 S**
Schoonmaker et al. (45) **Date of Patent:** **** Jun. 23, 2020**

(54) **GAMING MACHINE**

Primary Examiner — Cynthia Ramirez

Assistant Examiner — Michael A Maharajh

(71) Applicant: **Aristocrat Technologies Australia Pty Limited**, North Ryde, NSW (AU)

(74) *Attorney, Agent, or Firm* — McAndrews, Held & Malloy, Ltd.

(72) Inventors: **Rena Schoonmaker**, Las Vegas, NV (US); **Dominic DeMarco**, Round Rock, TX (US)

(57) **CLAIM**

(73) Assignee: **Aristocrat Technologies Australia Pty Limited**, North Ryde (AU)

The ornamental design for a gaming machine, as shown and described.

(**) Term: **15 Years**

DESCRIPTION

(21) Appl. No.: **29/680,138**

(22) Filed: **Feb. 13, 2019**

Related U.S. Application Data

(62) Division of application No. 29/619,823, filed on Oct. 2, 2017, now Pat. No. Des. 846,649.

(51) **LOC (12) Cl.** **21-03**

(52) **U.S. Cl.**
USPC **D21/369**

(58) **Field of Classification Search**
USPC D14/126, 127, 133, 305, 307, 340, 336,
D14/371, 374, 432, 439, 450; D21/324,
D21/325, 369, 370, 371, 385
CPC A63F 2009/2457; A63F 2009/241; A63F
13/00; A63F 9/24; H05K 5/0234; F16M
11/06

See application file for complete search history.

(56) **References Cited**

U.S. PATENT DOCUMENTS

3,780,286 A	12/1973	Alexieff et al.
D295,193 S	4/1988	Visocky et al.
D372,314 S	7/1996	Delman
D391,773 S	3/1998	Zaidman et al.
D392,468 S	3/1998	O'Reilly
D405,976 S	2/1999	Beall

(Continued)

FIG. 1 is a front perspective view of a gaming machine showing our new design according to a first embodiment; FIG. 2 is a front elevation view thereof; FIG. 3 is a rear elevation view thereof; FIG. 4 is a right side elevation view thereof; FIG. 5 is a left side elevation view thereof; FIG. 6 is a top plan view thereof; FIG. 7 is a bottom plan view thereof; FIG. 8 is another front elevation view thereof, showing our new design in an illuminated state; FIG. 9 is a front perspective view of a gaming machine showing our new design according to a second embodiment; FIG. 10 is a front elevation view thereof; FIG. 11 is a rear elevation view thereof; FIG. 12 is a right side elevation view thereof; FIG. 13 is a left side elevation view thereof; FIG. 14 is a top plan view thereof; FIG. 15 is a bottom plan view thereof; and, FIG. 16 is another front elevation view thereof, showing our new design in an illuminated state.

The dashed broken lines in the drawings illustrate portions of the gaming machine that form no part of the claimed design.

The radiating lines in FIGS. 8 and 16 represent the glowing visual effect created by light emanating from the light ring surrounding the upper displays of the gaming machine.

1 Claim, 12 Drawing Sheets

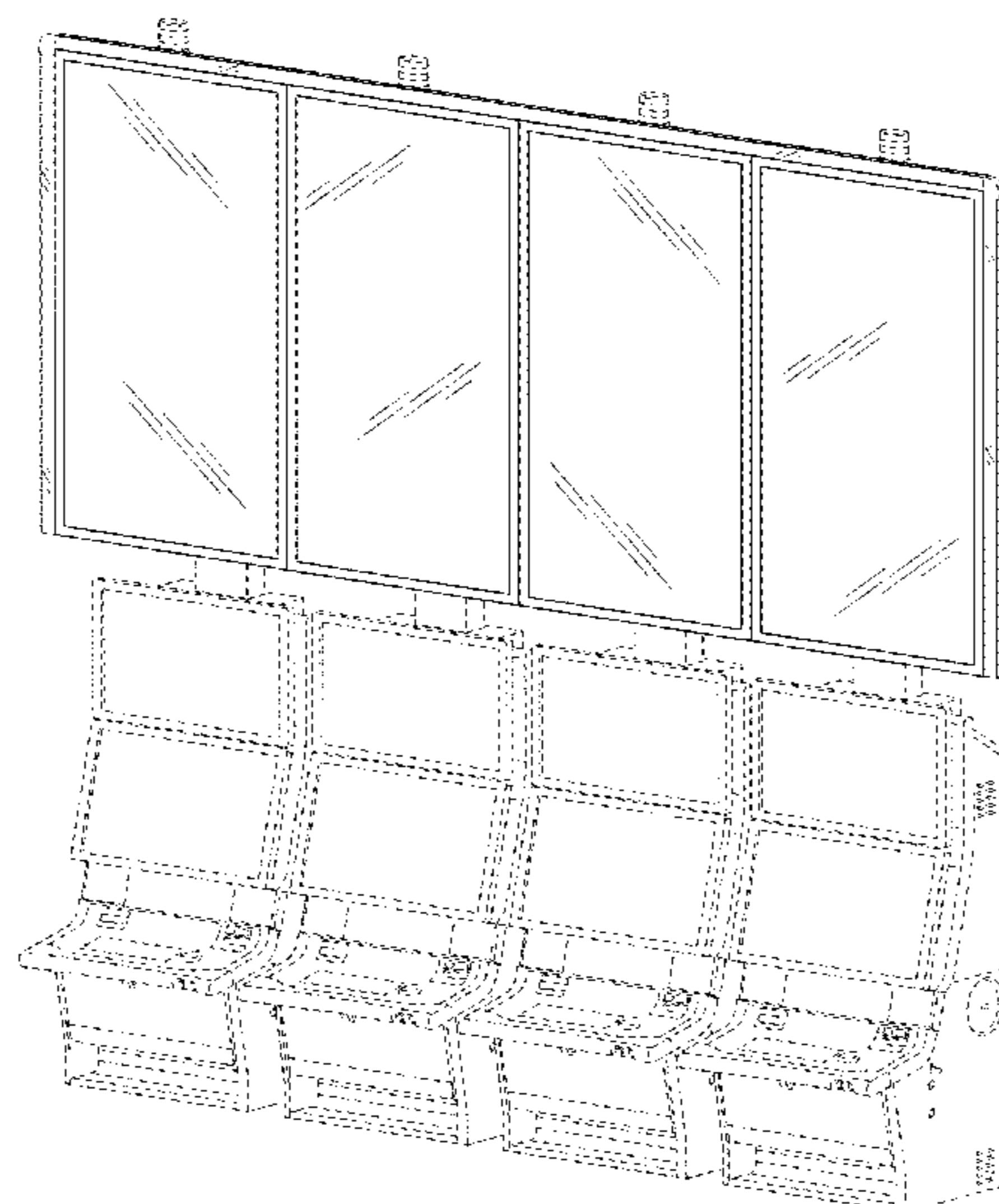

(56)

References Cited

U.S. PATENT DOCUMENTS

D411,582 S	6/1999	Muraki et al.	D715,364 S *	10/2014	Wudtke	D21/385
D503,435 S	3/2005	Morrison	D732,113 S	6/2015	Estep	
D503,436 S	3/2005	Morrison	D732,114 S	6/2015	Estep	
D510,959 S	10/2005	Morrison	D740,571 S	10/2015	Gorham	
D523,249 S	6/2006	Hoernig	D740,888 S	10/2015	DePalma et al.	
D544,922 S	6/2007	Shaffer	D790,232 S	6/2017	Santos	
D572,024 S	7/2008	Shapiro	D806,690 S	1/2018	Schimon	
D594,510 S	6/2009	Sappington et al.	10,013,061 B2	7/2018	Froy	
D602,996 S	10/2009	Takeuchi	10,013,845 B2	7/2018	Froy et al.	
D613,338 S	4/2010	Marukos	D832,356 S	10/2018	Castro et al.	
D636,187 S	4/2011	Kim et al.	D846,649 S *	4/2019	Schoonmaker	D21/369
D636,188 S	4/2011	Kim et al.	D868,714 S *	12/2019	Hodgson	D14/127
D639,568 S	6/2011	Lee et al.	D868,718 S *	12/2019	Hodgson	D14/127
D642,385 S	8/2011	Lee et al.	D868,719 S *	12/2019	Hodgson	D14/127
D676,430 S	2/2013	Blaser	10,506,730 B2 *	12/2019	Wand	
8,382,572 B2	2/2013	Hoffman et al.	D877,810 S *	3/2020	Nelson	D21/369
8,491,385 B2	7/2013	Miodunski	D880,604 S *	4/2020	Olive	D21/369
			2018/0040203 A1	2/2018	Winters et al.	
			2018/0082545 A1	3/2018	Winters et al.	
			2019/0102971 A1 *	4/2019	Schoonmaker	F16M 11/06

* cited by examiner

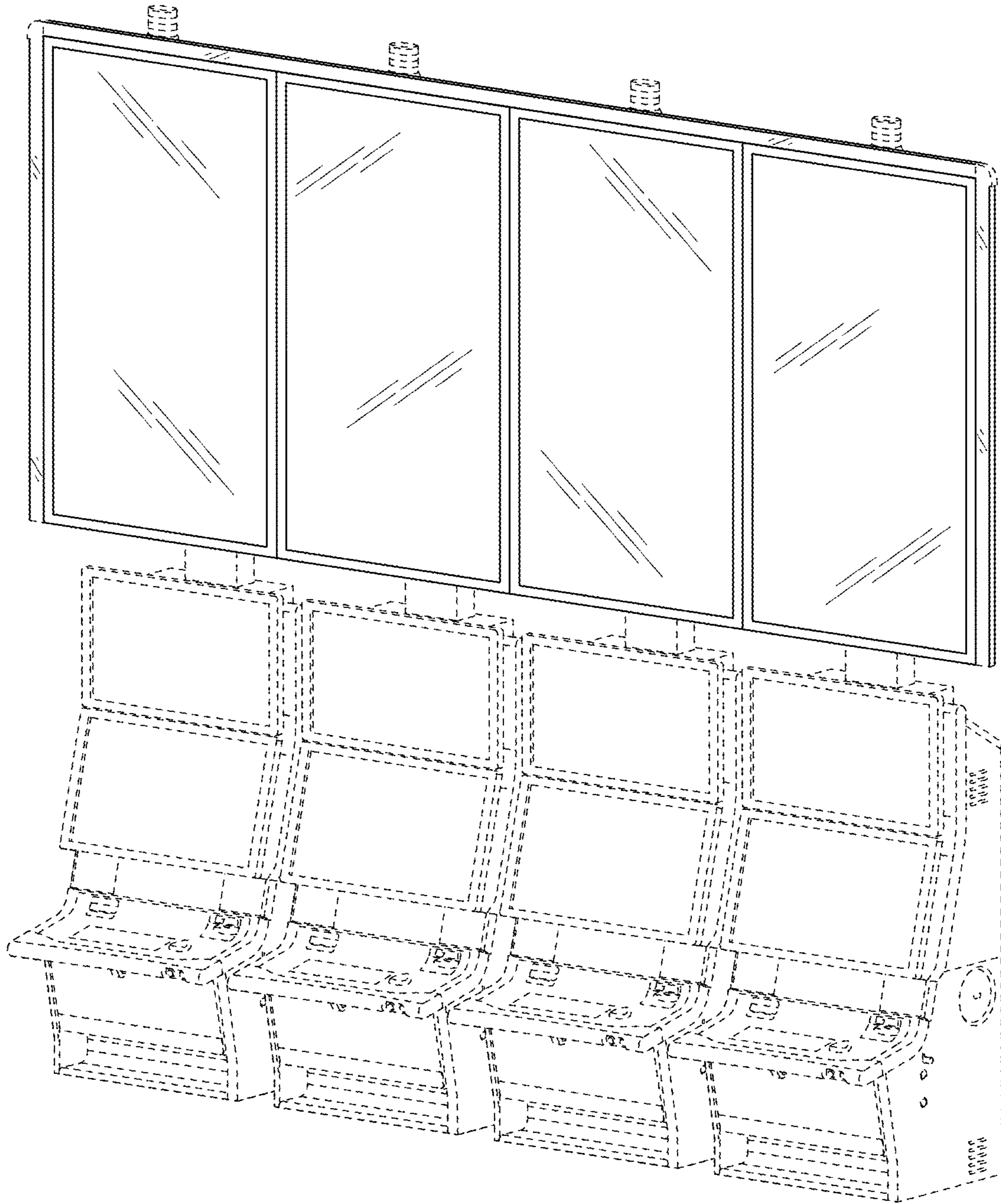

FIG. 1

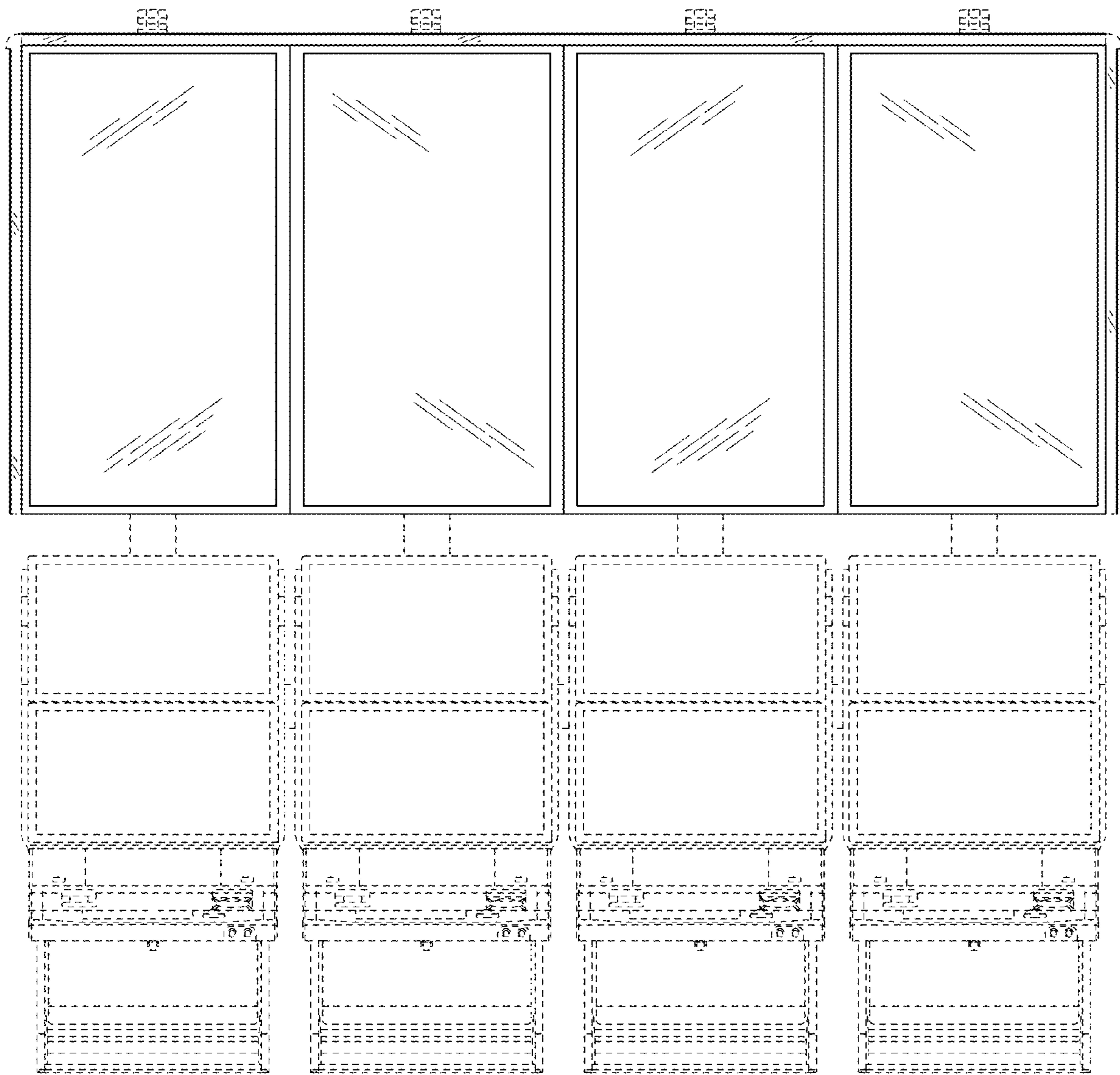

FIG. 2

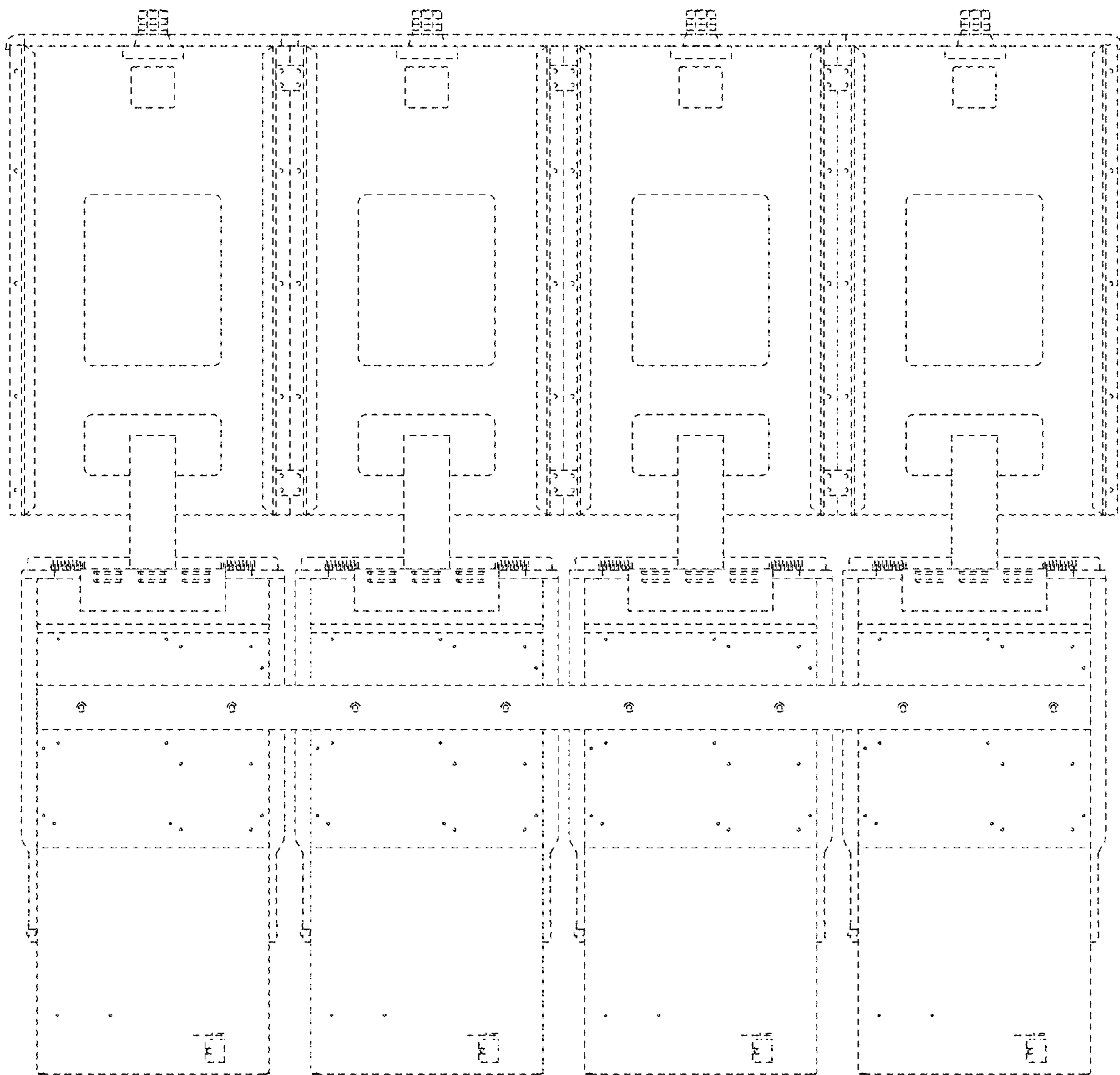

FIG. 3

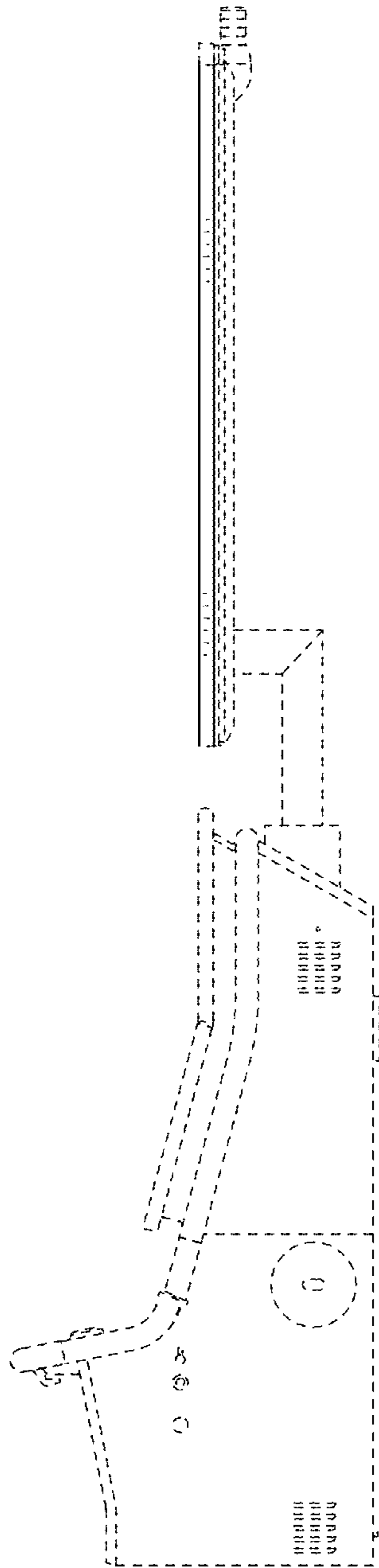

FIG. 4

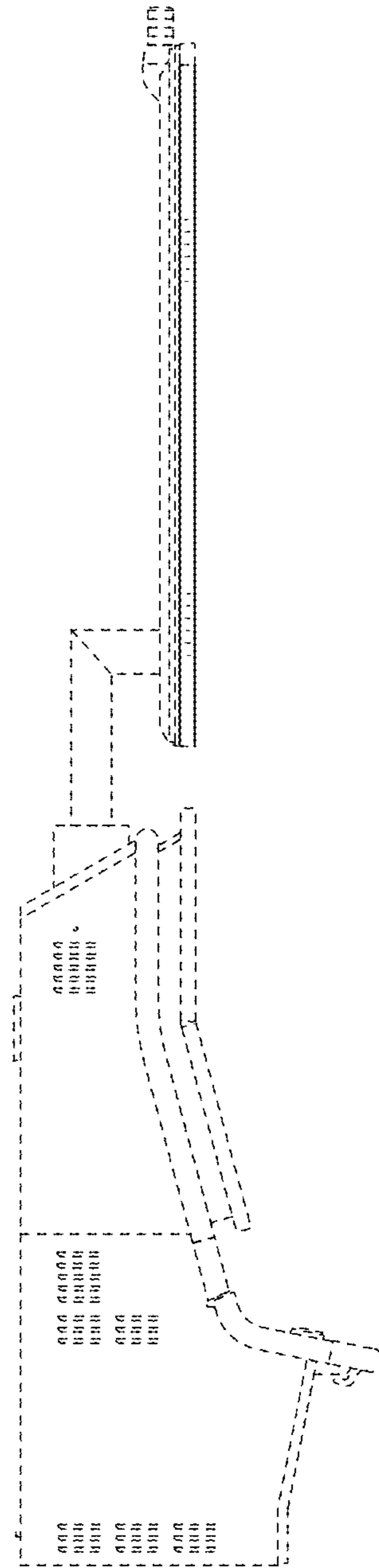

FIG. 5

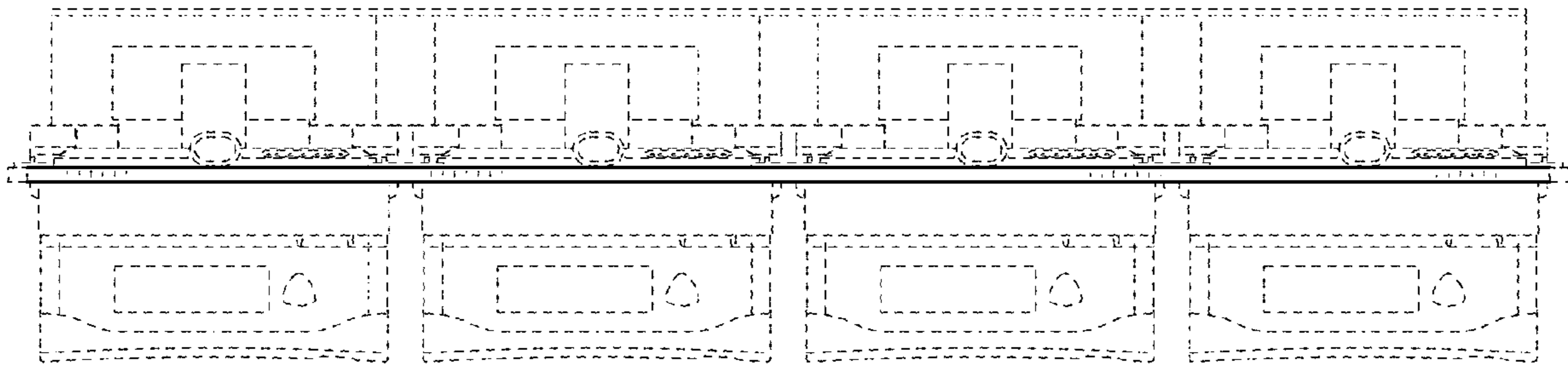

FIG. 6

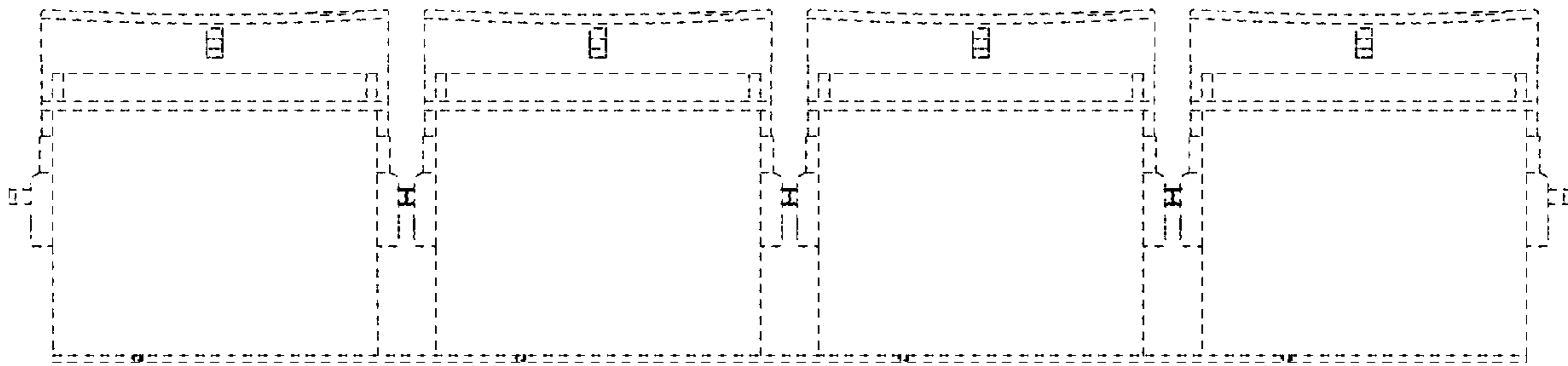

FIG. 7



FIG. 8

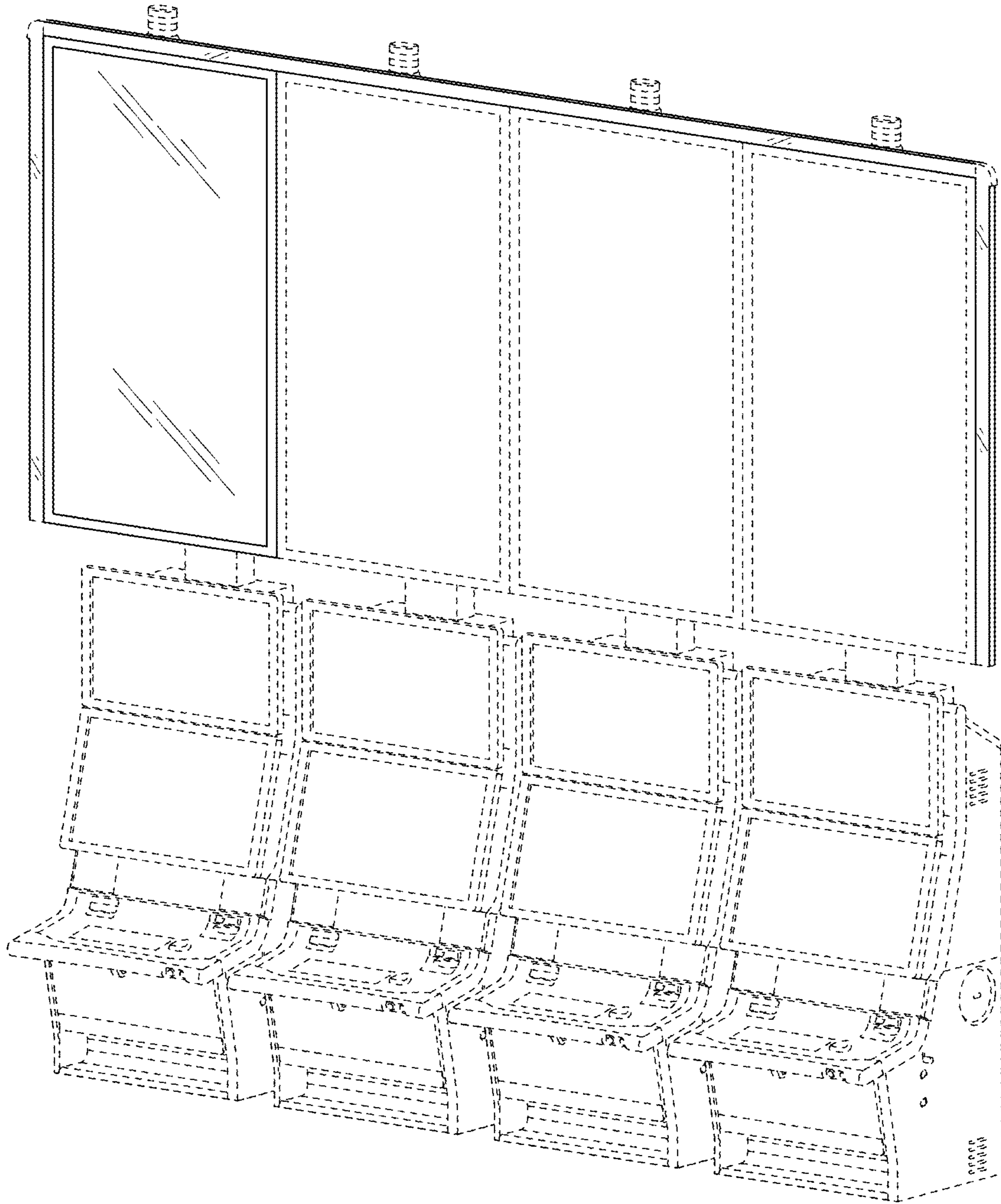

FIG. 9

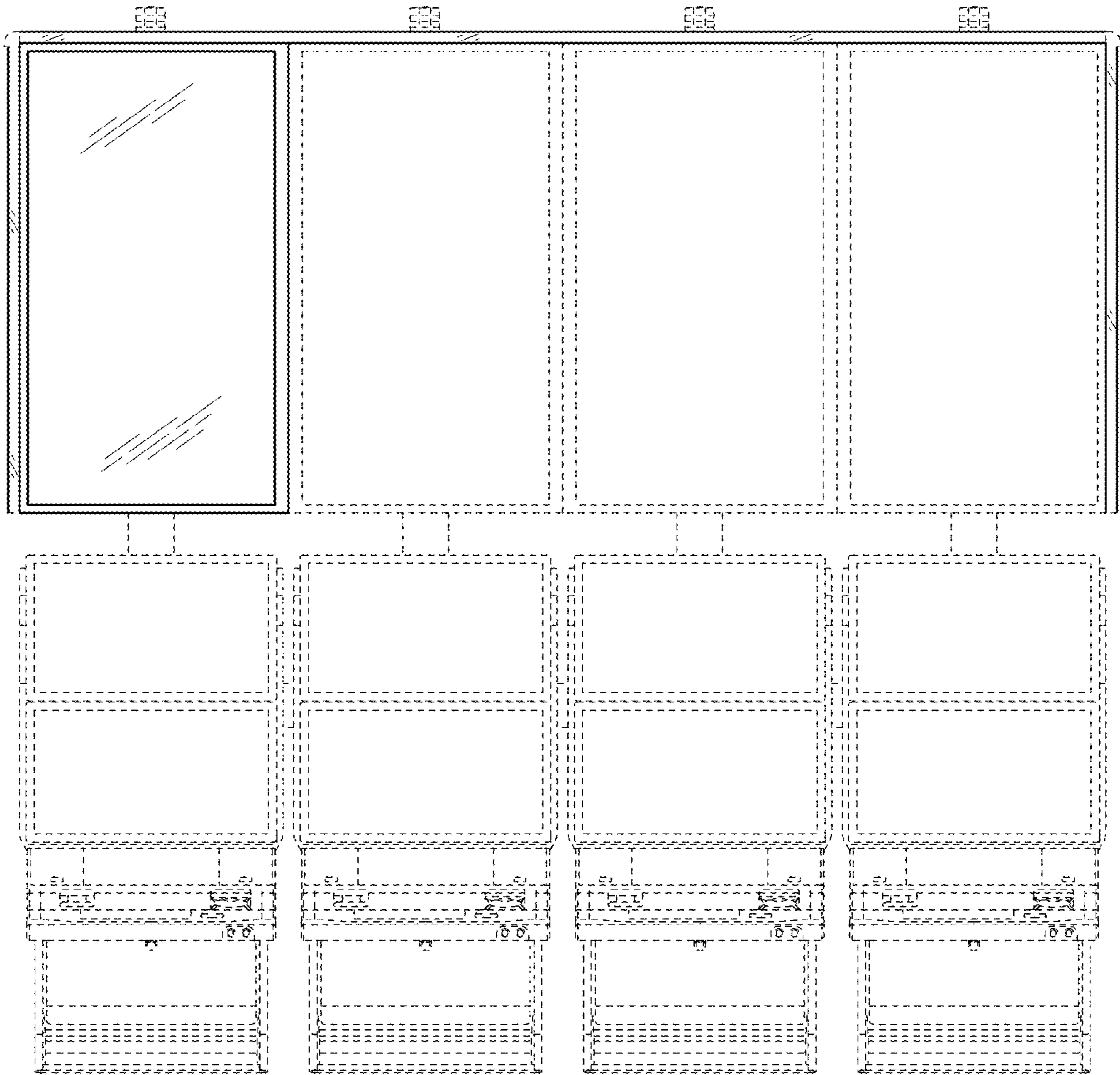

FIG. 10

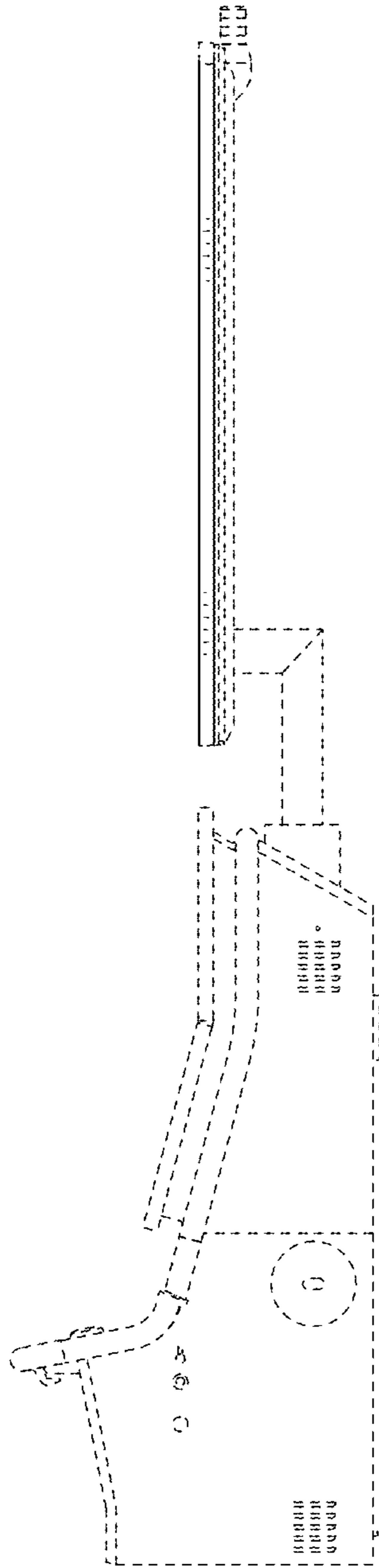

FIG. 12

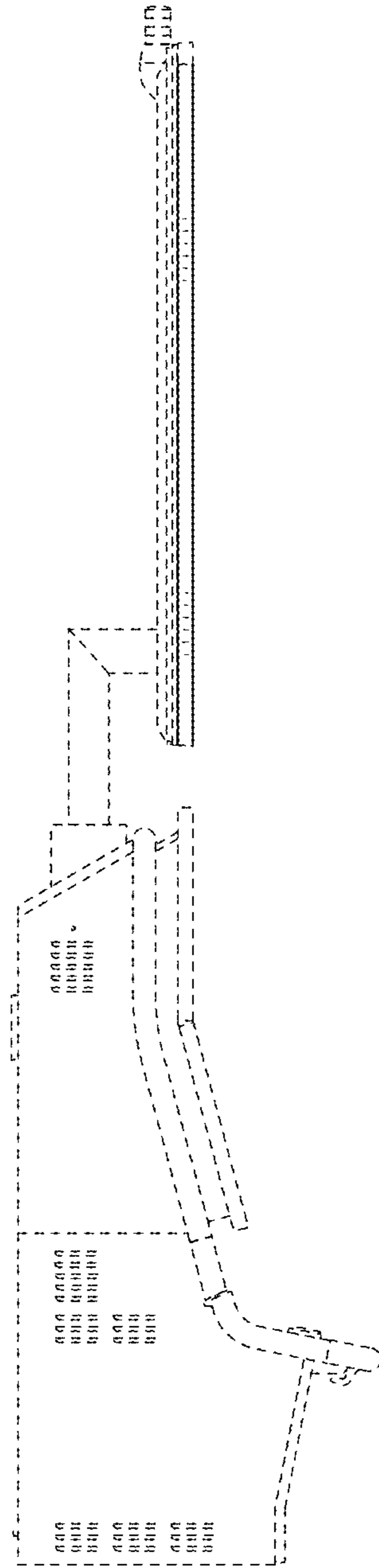

FIG. 13

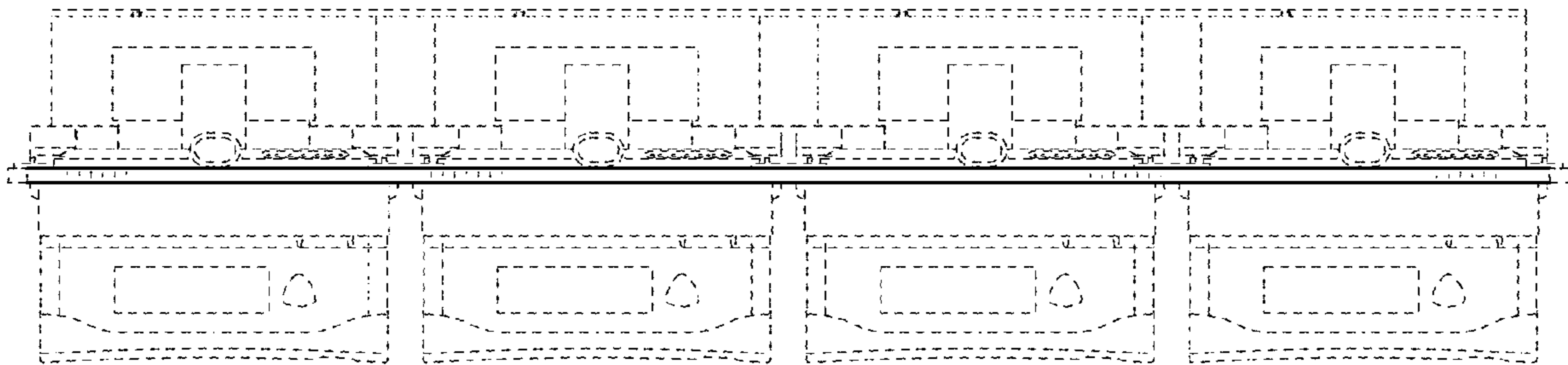

FIG. 14

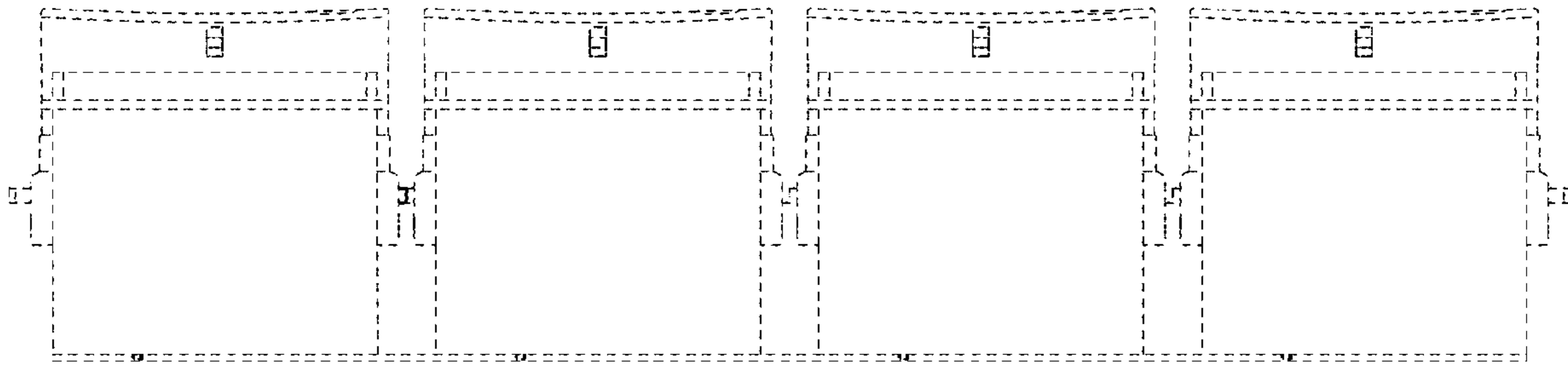

FIG. 15

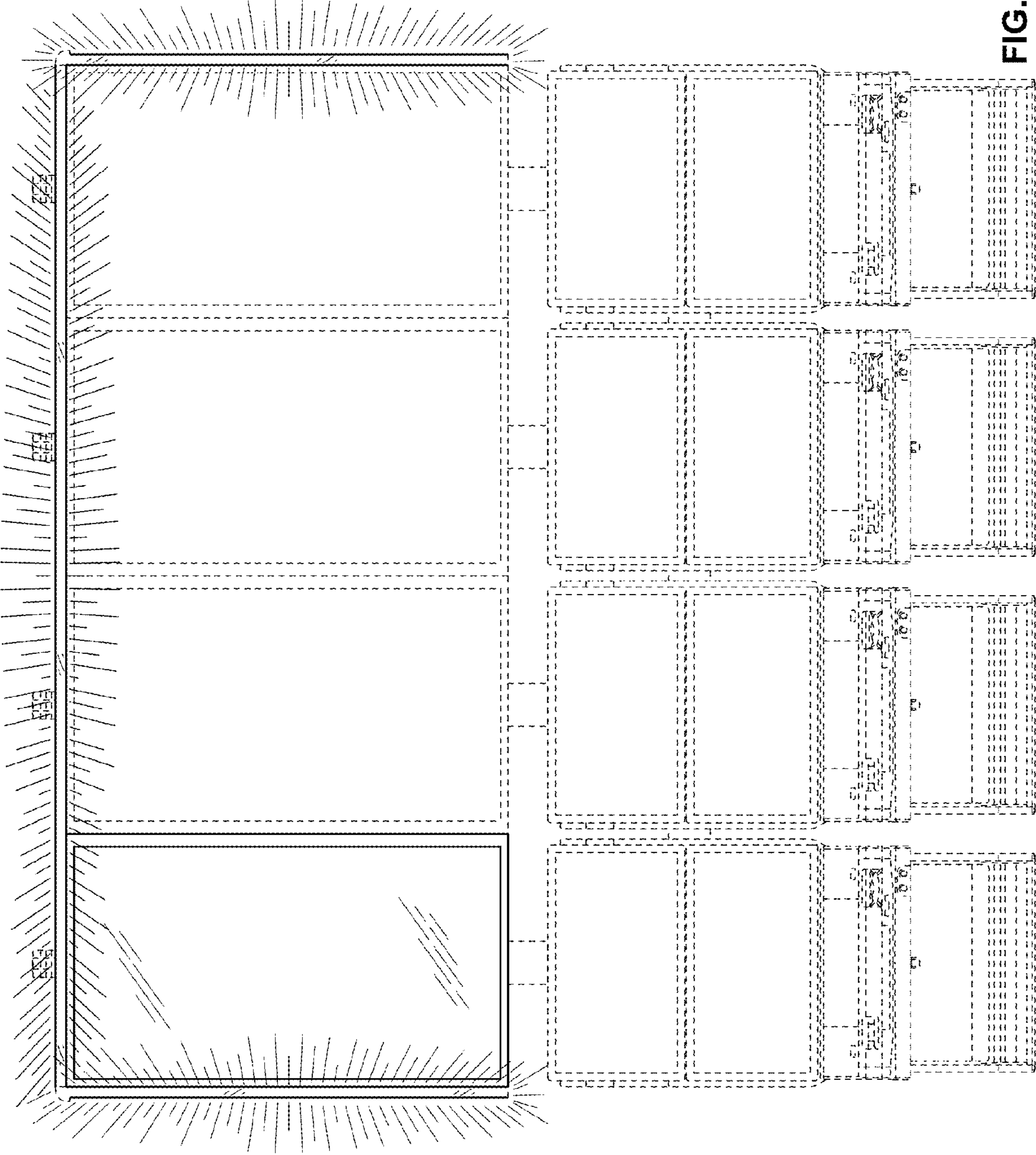

FIG. 16