



US00D887929S

(12) **United States Design Patent** (10) **Patent No.:** **US D887,929 S**
Piaskowski et al. (45) **Date of Patent:** **** Jun. 23, 2020**

(54) **VEHICLE CENTER DISPLAY**
(71) Applicant: **Ford Global Technologies, LLC,**
Dearborn, MI (US)
(72) Inventors: **Joel Piaskowski,** Dusseldorf (DE);
Gordon Platto, Troy, MI (US); **Doyle**
Letson, Novi, MI (US); **Paul Johnston,**
Northville, MI (US); **Andy Thomas,**
Northville, MI (US); **Jim Smithbauer,**
West Bloomfield, MI (US); **Rachael**
Robinson, Royal Oak, MI (US); **Josh**
Greiner, Detroit, MI (US)

(73) Assignee: **Ford Global Technologies, LLC,**
Dearborn, MI (US)

(**) Term: **15 Years**

(21) Appl. No.: **29/685,579**

(22) Filed: **Mar. 29, 2019**

(51) **LOC (12) Cl.** **12-16**

(52) **U.S. Cl.**
USPC **D12/192**

(58) **Field of Classification Search**
USPC D12/192, 415, 114, 345; D15/17, 28;
D10/46, 98, 102-103, 122-12; D23/324
CPC B60H 1/34; B60H 1/3407; B60H 1/3414;
B60H 1/3421; B60H 1/3428; B60H
1/3435; B60H 1/3442; B60H 1/345;
B60H 1/3457; B60H 2001/3464; B60H
2001/3471; B60H 2001/3478; B60H
2001/3485

See application file for complete search history.

(56) **References Cited**

U.S. PATENT DOCUMENTS

9,403,489 B2 * 8/2016 Angeletti B60R 11/0241
D778,250 S * 2/2017 Owens D14/129

D792,362 S * 7/2017 Maxwell D14/130
D815,002 S * 4/2018 Niemiec D12/192
D839,158 S * 1/2019 Buffery D12/192
D840,304 S * 2/2019 Kang D12/192
D849,622 S * 5/2019 Woodhouse D12/192
D856,880 S * 8/2019 Tomasson D12/192
D867,948 S * 11/2019 Engelmann D12/192
2014/0125876 A1 * 5/2014 Nakayama H04N 5/64
348/837
2015/0001870 A1 * 1/2015 Parcher B60K 35/00
296/1.07
2017/0274773 A1 * 9/2017 Woodhouse B60K 35/00
2017/0315354 A1 * 11/2017 Park G02B 27/0149

* cited by examiner

Primary Examiner — Katrina A Betton

(74) *Attorney, Agent, or Firm* — Vichit Chea

(57) **CLAIM**

The ornamental design for a vehicle center display, as shown and described.

DESCRIPTION

FIG. 1 is a front elevational view of a vehicle center display, showing our new design;
FIG. 2 is a rear elevational view thereof;
FIG. 3 is a left side elevational view thereof;
FIG. 4 is a right side elevational view thereof;
FIG. 5 is a top plan view thereof;
FIG. 6 is a top, front and left side perspective view thereof; and,
FIG. 7 is a bottom, front and left side perspective view thereof.

The claimed design is indicated by the relatively dark portions in the figures. The relatively light portions form no part of the claimed design.

1 Claim, 7 Drawing Sheets

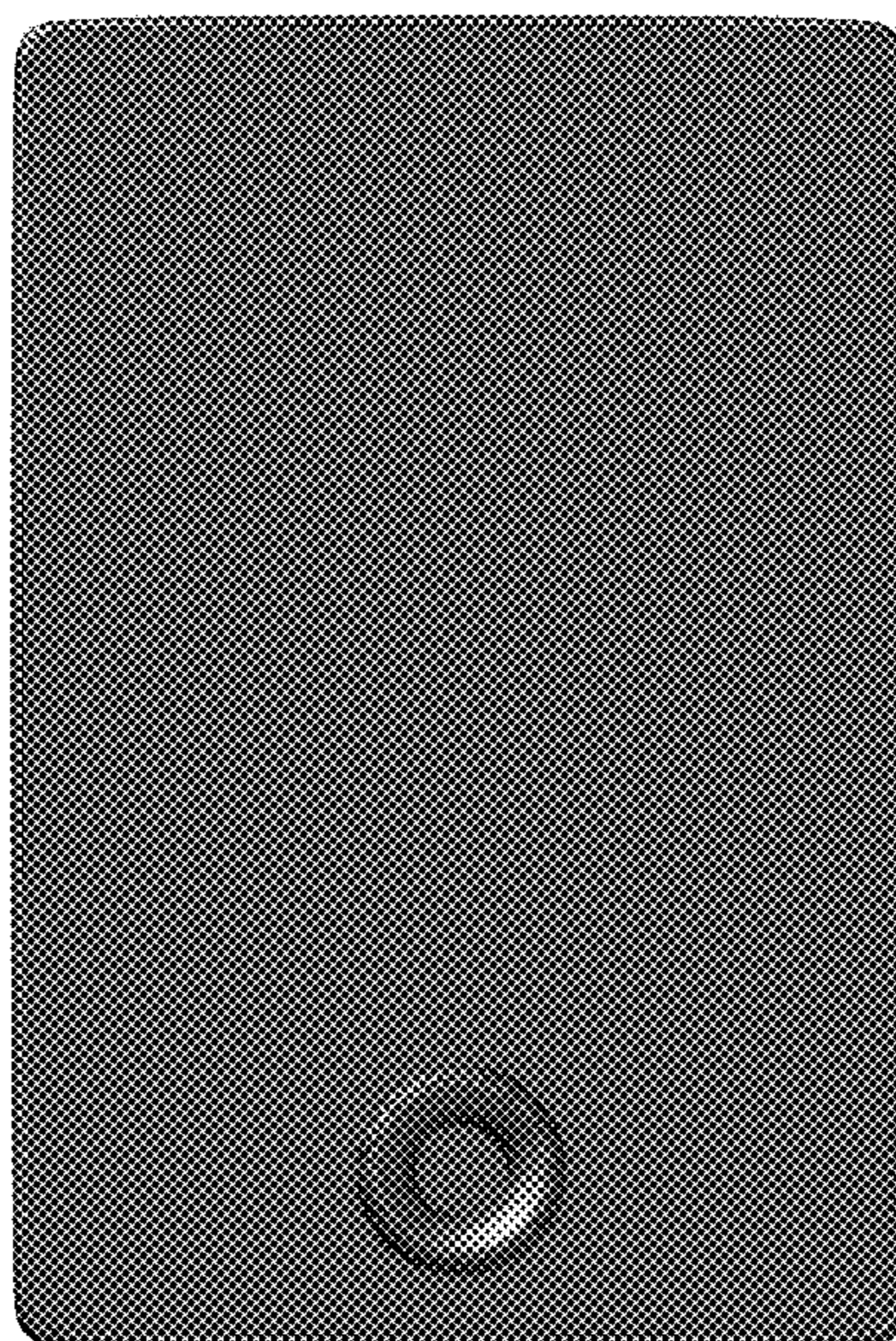

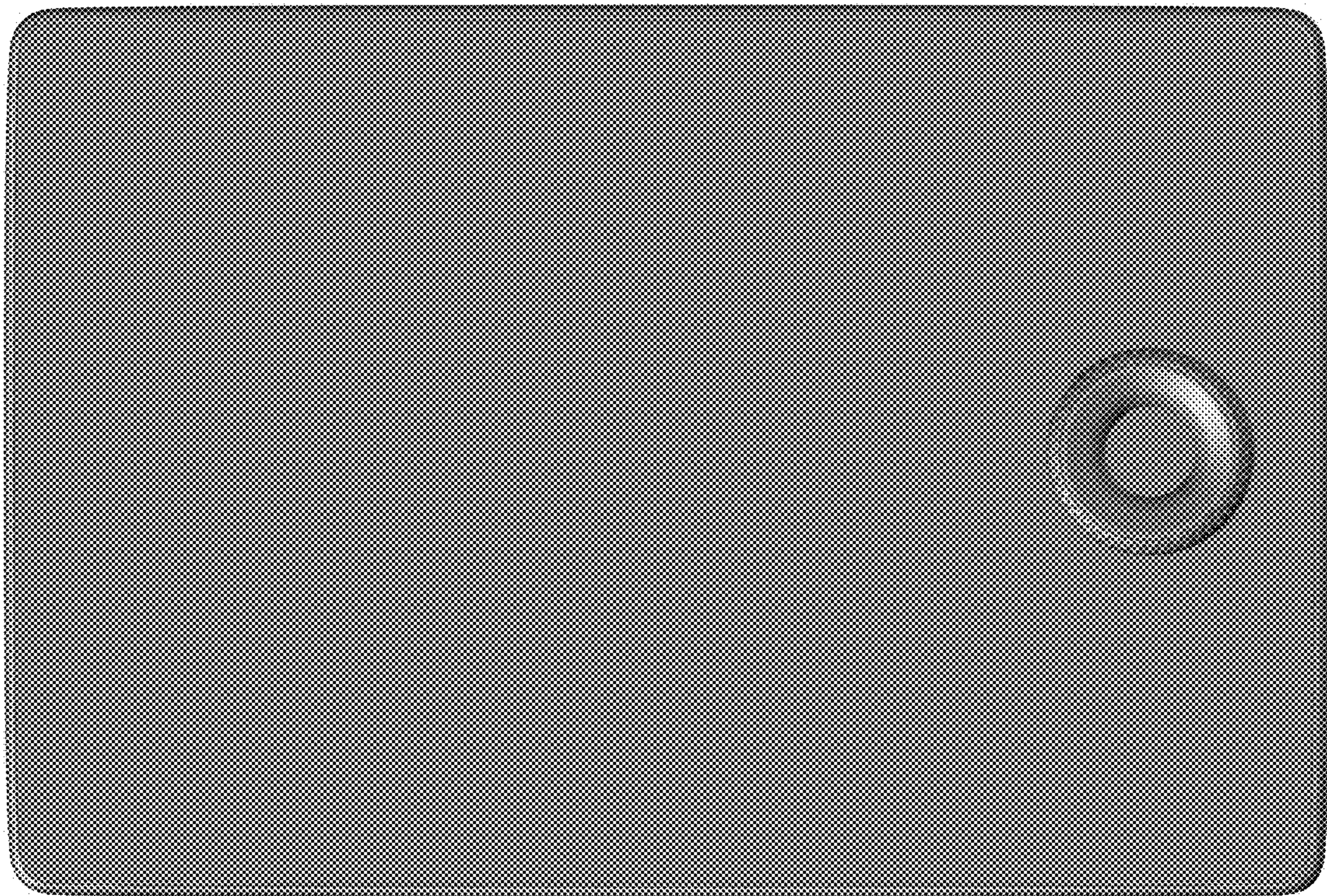

Fig. 1

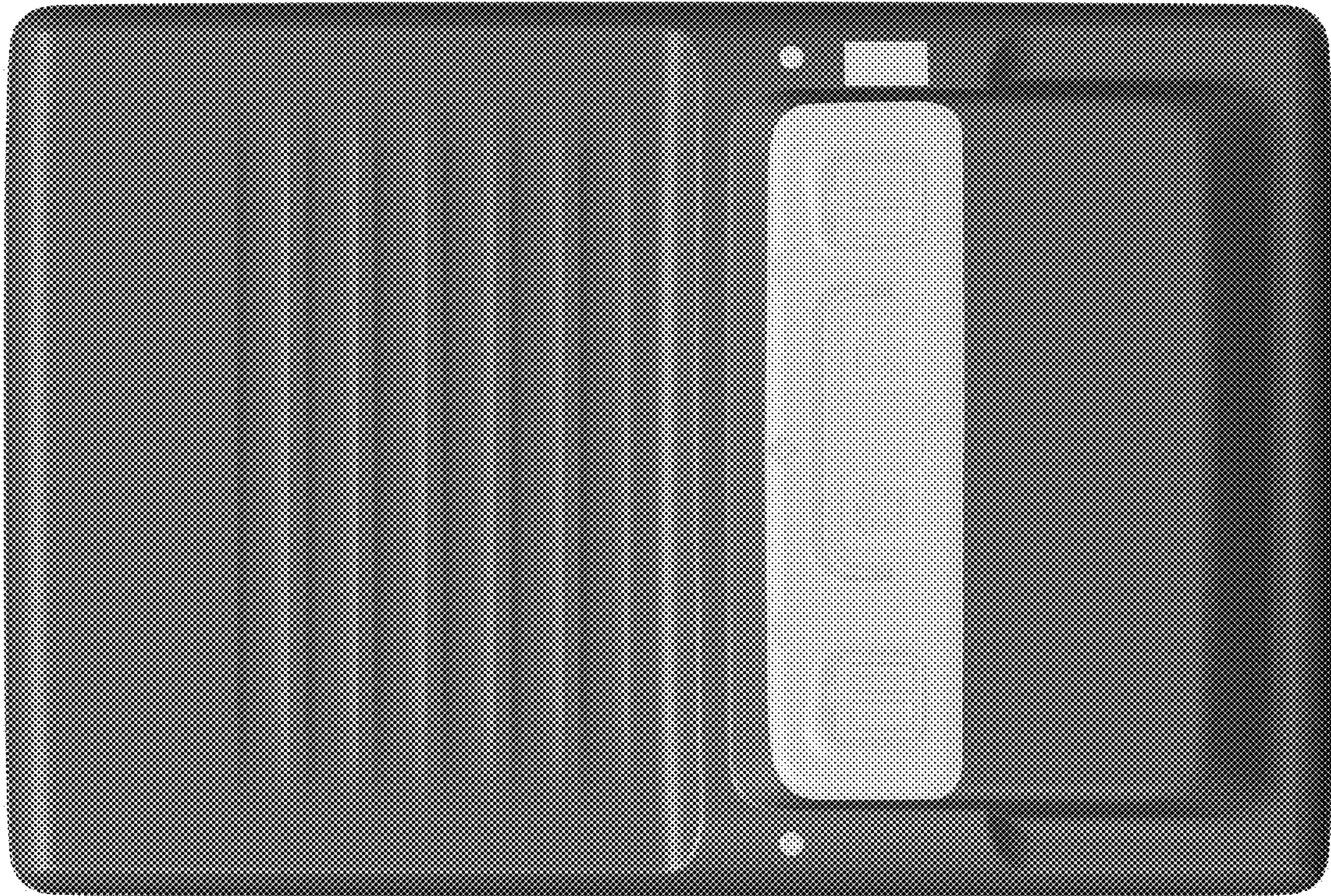
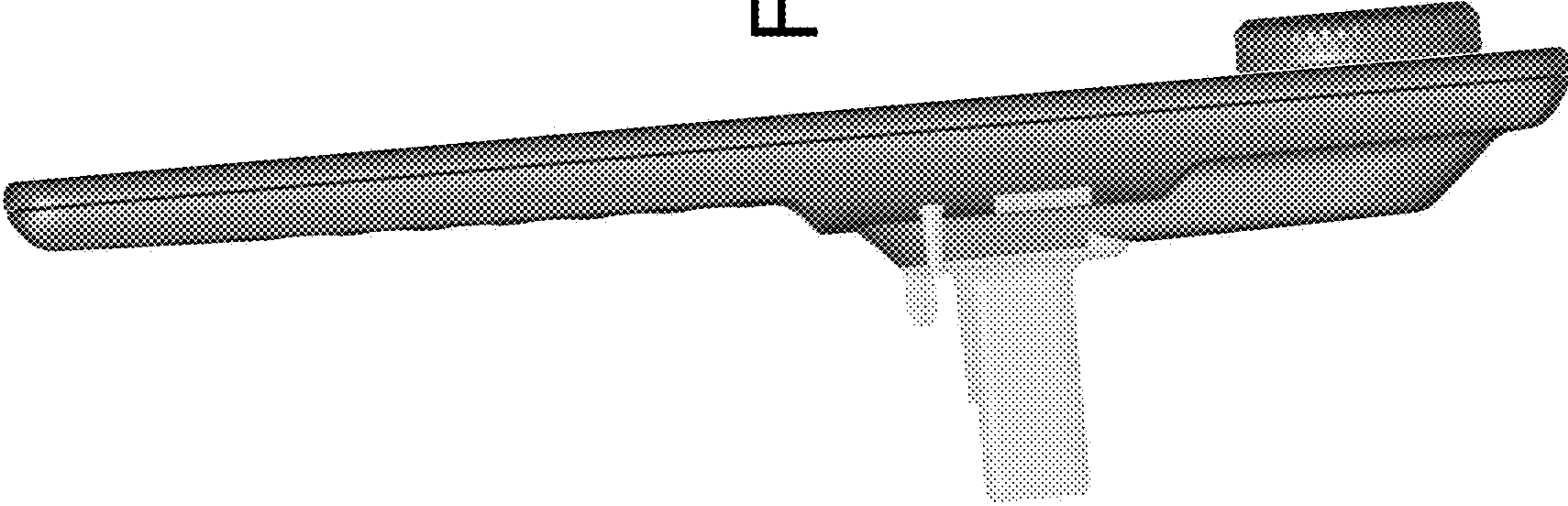

Fig.2

Fig. 3



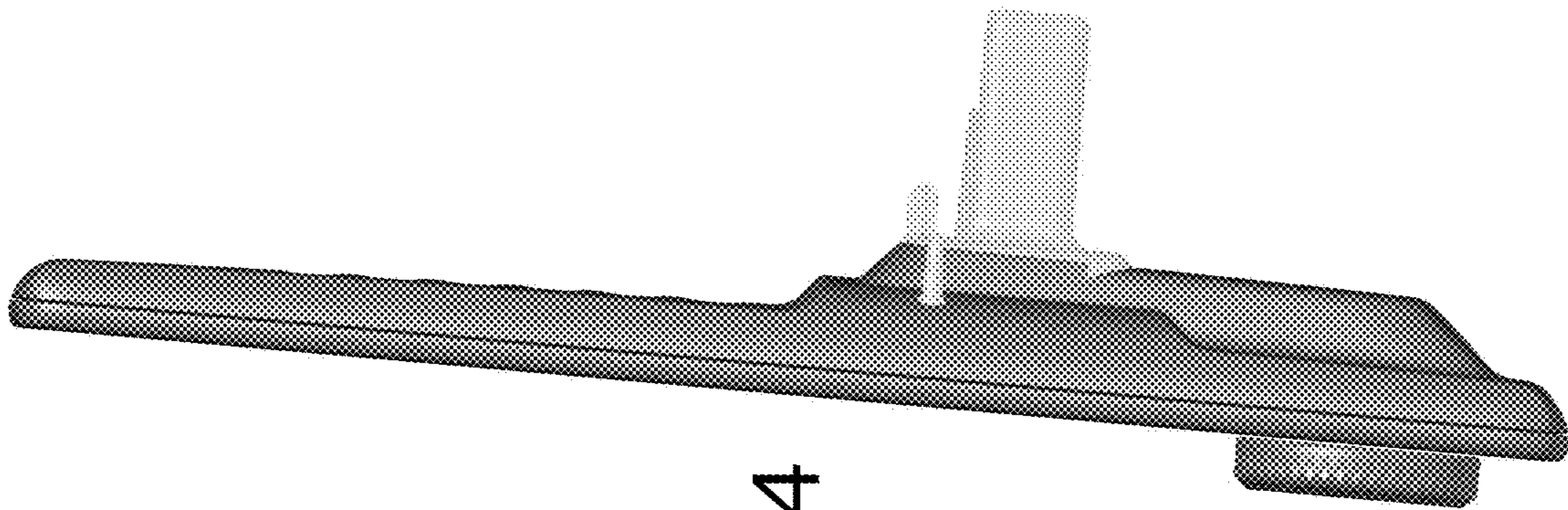

Fig. 4

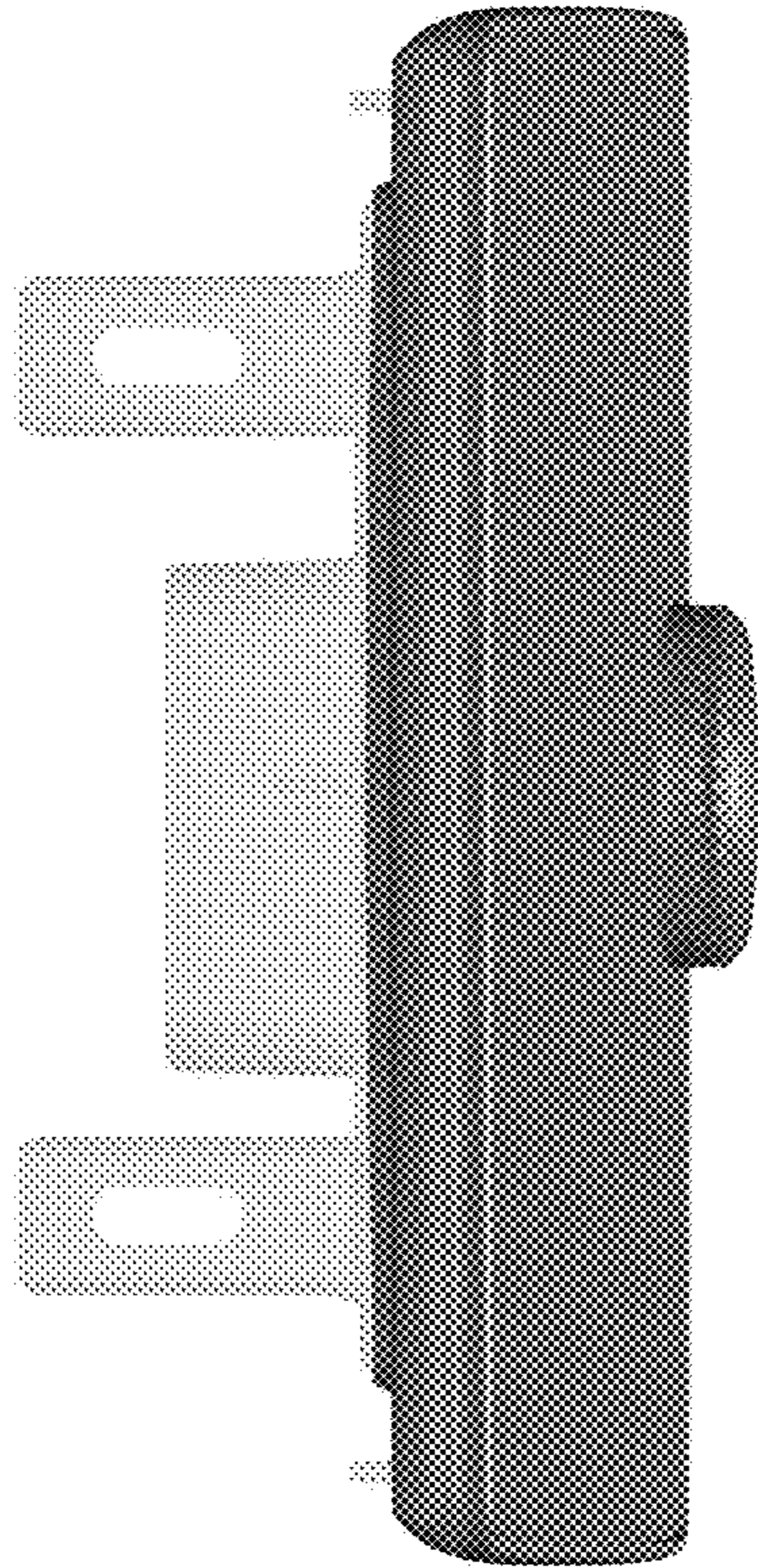

Fig. 5

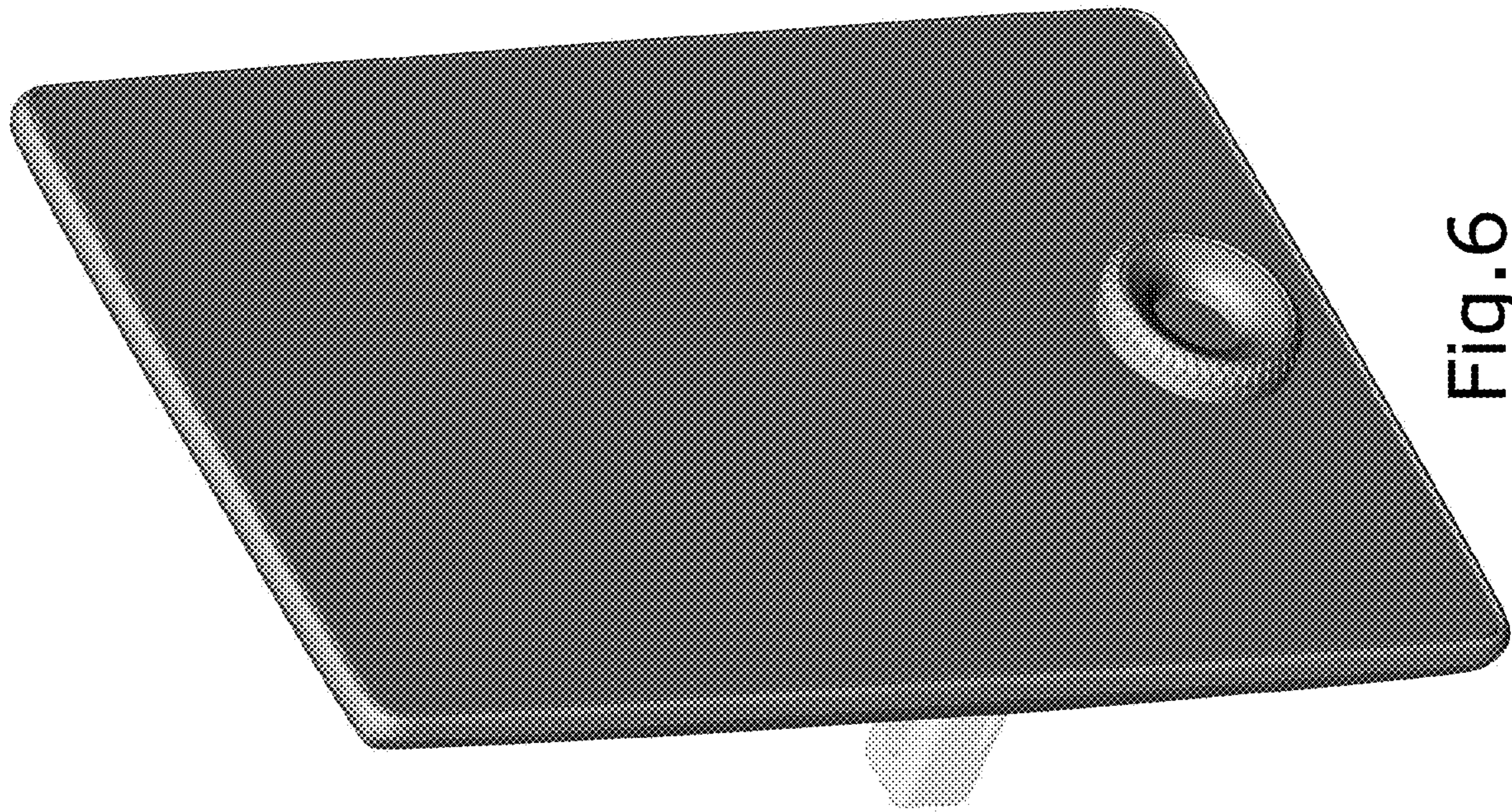

Fig. 6

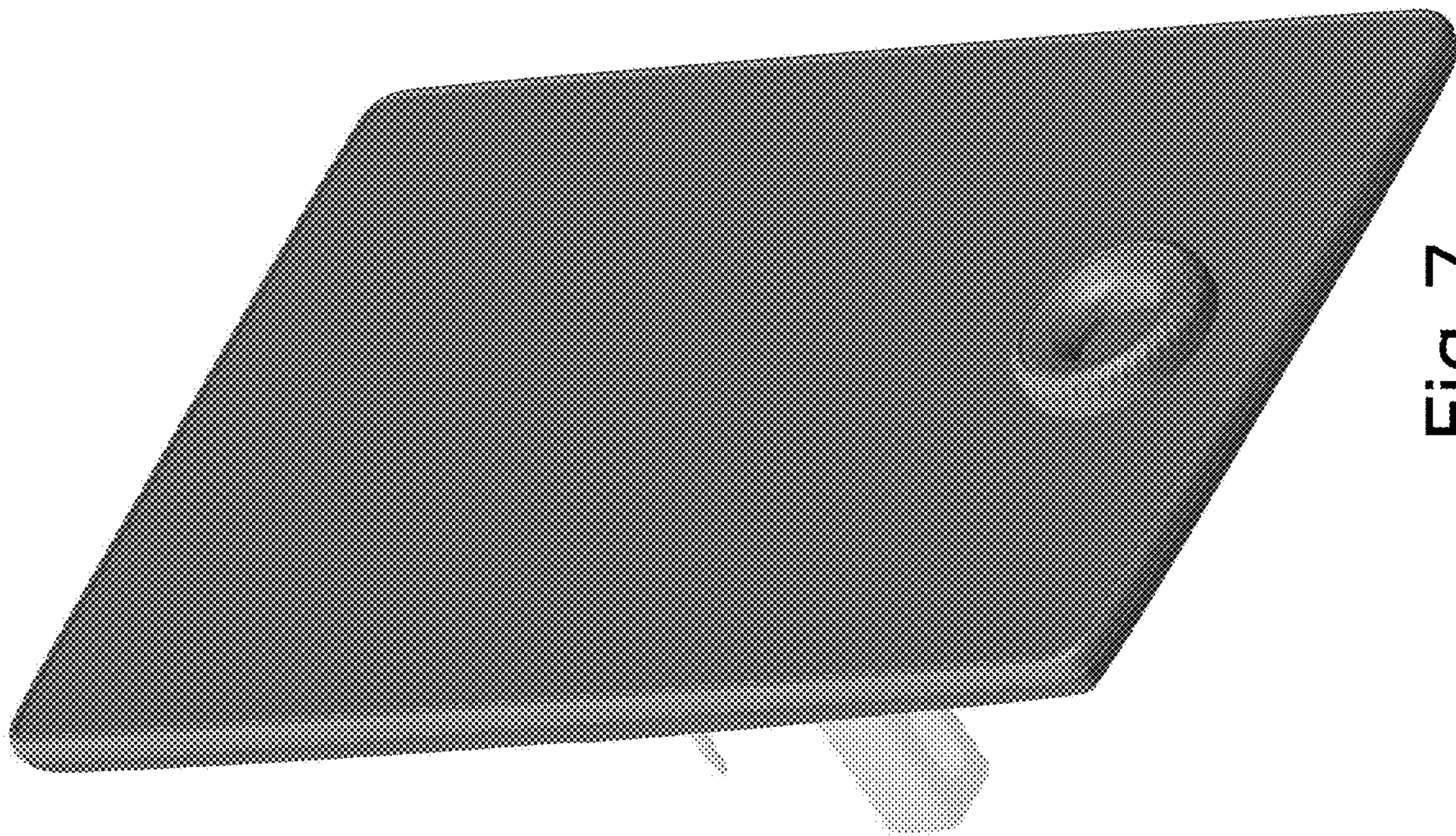

Fig. 7