



US00D887889S

(12) **United States Design Patent** (10) **Patent No.:** **US D887,889 S**  
**Khwaja et al.** (45) **Date of Patent:** **\*\* Jun. 23, 2020**

(54) **VERTICAL FARMING UNIT**

D600,944 S \* 9/2009 McConnell ..... D6/675  
D610,212 S \* 2/2010 Pedersen ..... D21/499  
D616,044 S \* 5/2010 Tervo ..... D21/499

(71) Applicant: **Aamar Khwaja**, Toronto (CA)

(Continued)

(72) Inventors: **Aamar Khwaja**, Toronto (CA); **James Henderson**, Gatineau (CA); **Derek Kirkland**, Chelsea (CA)

*Primary Examiner* — Elizabeth A. Albert

(74) *Attorney, Agent, or Firm* — Norton Rose Fulbright Canada LLP

(\*\*) Term: **15 Years**

(57) **CLAIM**

(21) Appl. No.: **29/651,222**

The ornamental design for a vertical farming unit, as shown and described.

(22) Filed: **Feb. 16, 2018**

**DESCRIPTION**

(51) **LOC (12) Cl.** ..... **11-02**

(52) **U.S. Cl.**  
USPC ..... **D11/155**

(58) **Field of Classification Search**  
USPC ..... D3/304; D6/403–405, 556–558, 512, D6/672, 675, 675.1, 717; D7/640, 641; D9/500, 549, 428; D11/143–156, 164  
CPC ..... A01G 9/02; A01G 9/021; A01G 9/022; A01G 9/025; A01G 9/026; A01G 9/028; A01G 9/029; A01G 9/0291; A01G 9/0293; A01G 9/0295; A01G 9/0297; A01G 9/0299; A01G 9/04; A01G 9/045  
See application file for complete search history.

FIG. 1 is a perspective view of a vertical farming unit showing our new design;  
FIG. 2 is a front view thereof;  
FIG. 3 is a rear view thereof;  
FIG. 4 is a top view thereof;  
FIG. 5 is a bottom view thereof;  
FIG. 6 is a left side view thereof;  
FIG. 7 is a right side view thereof;  
FIG. 8 is a perspective view of a vertical farming unit showing a second embodiment thereof;  
FIG. 9 is a front view thereof;  
FIG. 10 is a rear view thereof;  
FIG. 11 is a top view thereof;  
FIG. 12 is a bottom view thereof;  
FIG. 13 is a left side view thereof;  
FIG. 14 is a right side view thereof;  
FIG. 15 is a perspective view of a vertical farming unit showing a third embodiment thereof;  
FIG. 16 is a front view thereof;  
FIG. 17 is a rear view thereof;  
FIG. 18 is a top view thereof;  
FIG. 19 is a bottom view thereof;  
FIG. 20 is a left side view thereof; and,  
FIG. 21 is a right side view thereof.

(56) **References Cited**

U.S. PATENT DOCUMENTS

D185,509 S \* 6/1959 Pederson ..... D6/301  
D232,289 S \* 8/1974 Moretine ..... D6/675.1  
D234,894 S \* 4/1975 Vandenbeuck ..... D6/675.1  
D236,777 S \* 9/1975 Loomis ..... D6/675.1  
4,407,911 A \* 10/1983 Hooke ..... H01M 2/105  
429/159  
D273,021 S \* 3/1984 Chalabian ..... D20/6  
D306,106 S \* 2/1990 Bush ..... D6/661  
D316,873 S \* 5/1991 Merl ..... D20/6  
5,310,071 A \* 5/1994 Rivlin ..... B65D 81/361  
206/509  
D490,616 S \* 6/2004 Ljahnicky ..... D6/329  
D553,393 S \* 10/2007 Cassel ..... D6/675.1

Broken lines in the drawing depict portions of the vertical farming unit that form no part of the claimed design.

**1 Claim, 21 Drawing Sheets**

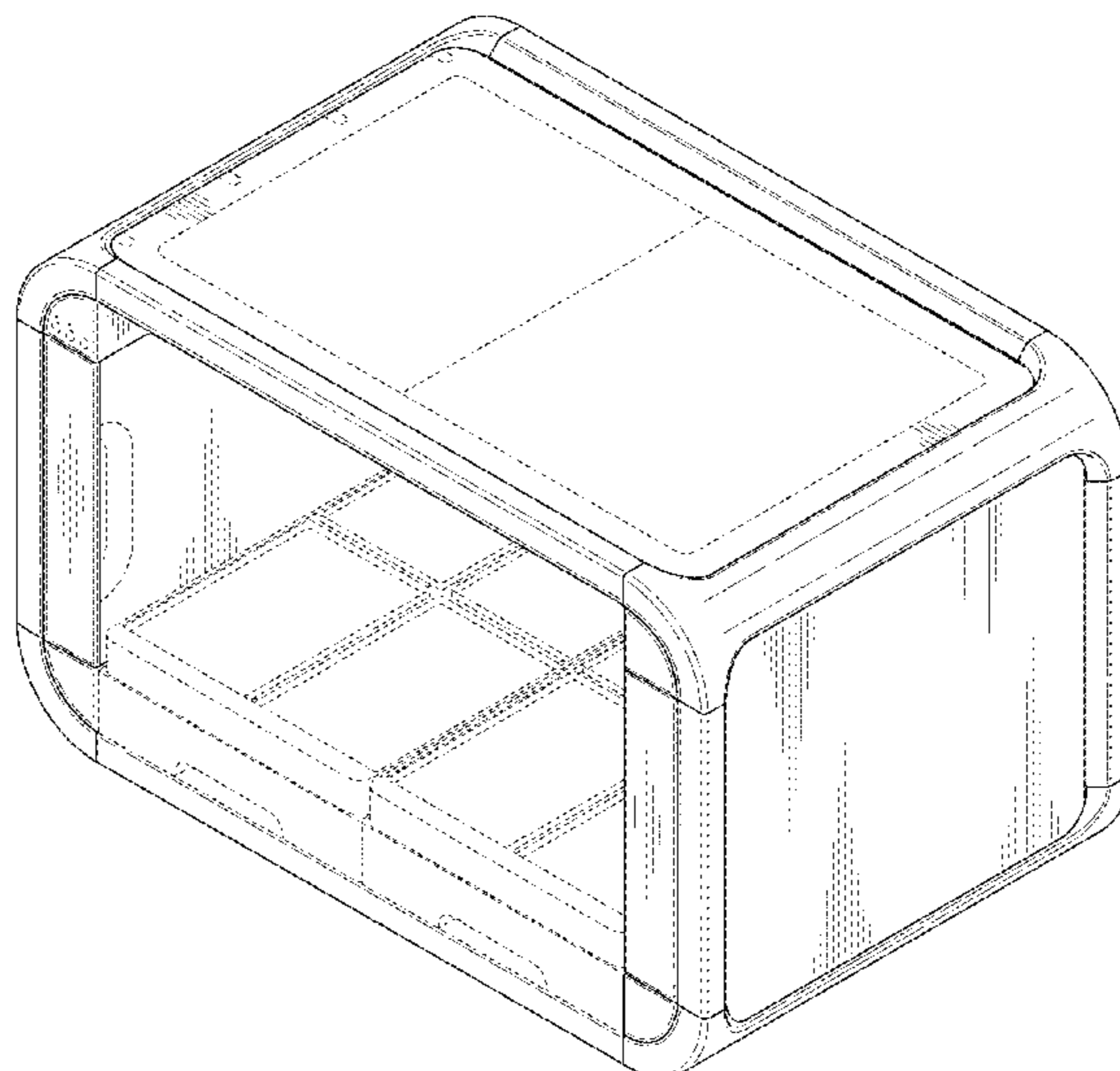

(56)

**References Cited**

U.S. PATENT DOCUMENTS

D616,045 S *	5/2010	Tervo .....	D21/499
D623,443 S *	9/2010	Zambelli .....	D6/661
D681,548 S *	5/2013	Zhang .....	D13/102
D695,350 S *	12/2013	Doleshal .....	D20/99
D698,869 S *	2/2014	Strzelewicz .....	D21/499
D733,196 S *	6/2015	Wolf .....	D15/122
D745,903 S *	12/2015	Armani .....	D15/122
D760,306 S *	6/2016	Wolf .....	D15/122
D776,727 S *	1/2017	Wolf .....	D15/122
D842,130 S *	3/2019	Xiao .....	D10/26
D850,501 S *	6/2019	Schmitt .....	D15/122

\* cited by examiner

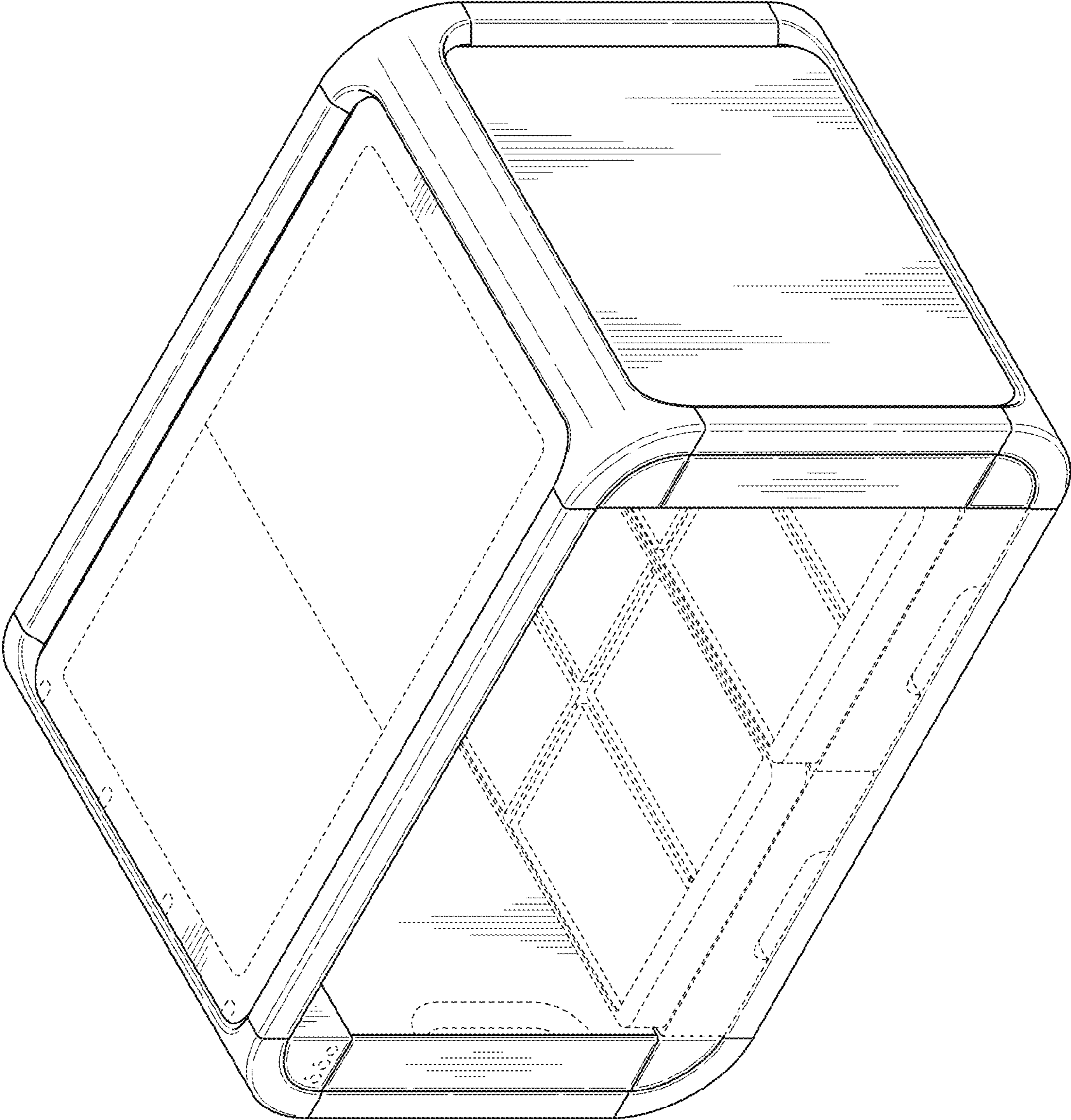

FIG. 1

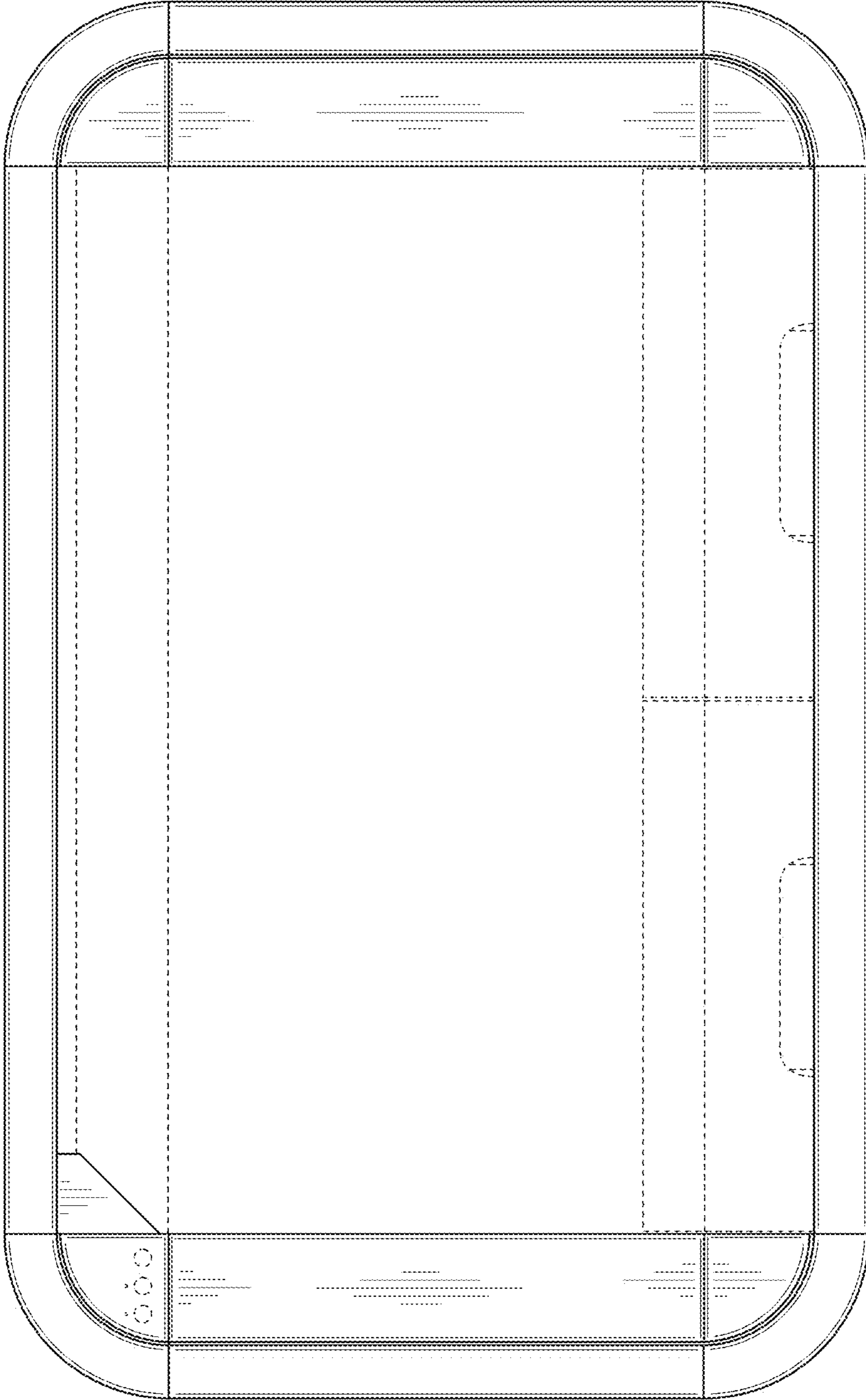

FIG. 2



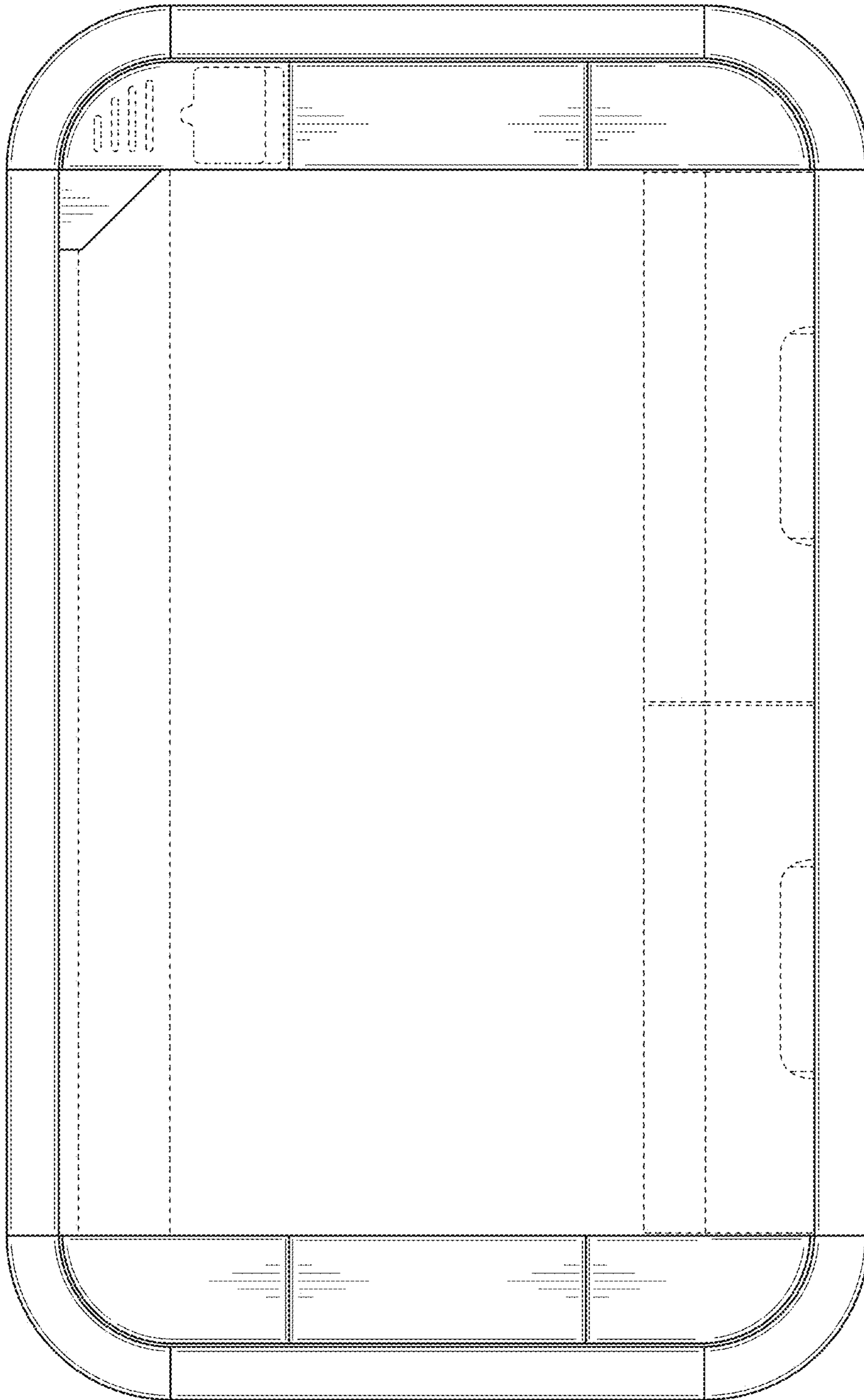

FIG. 3

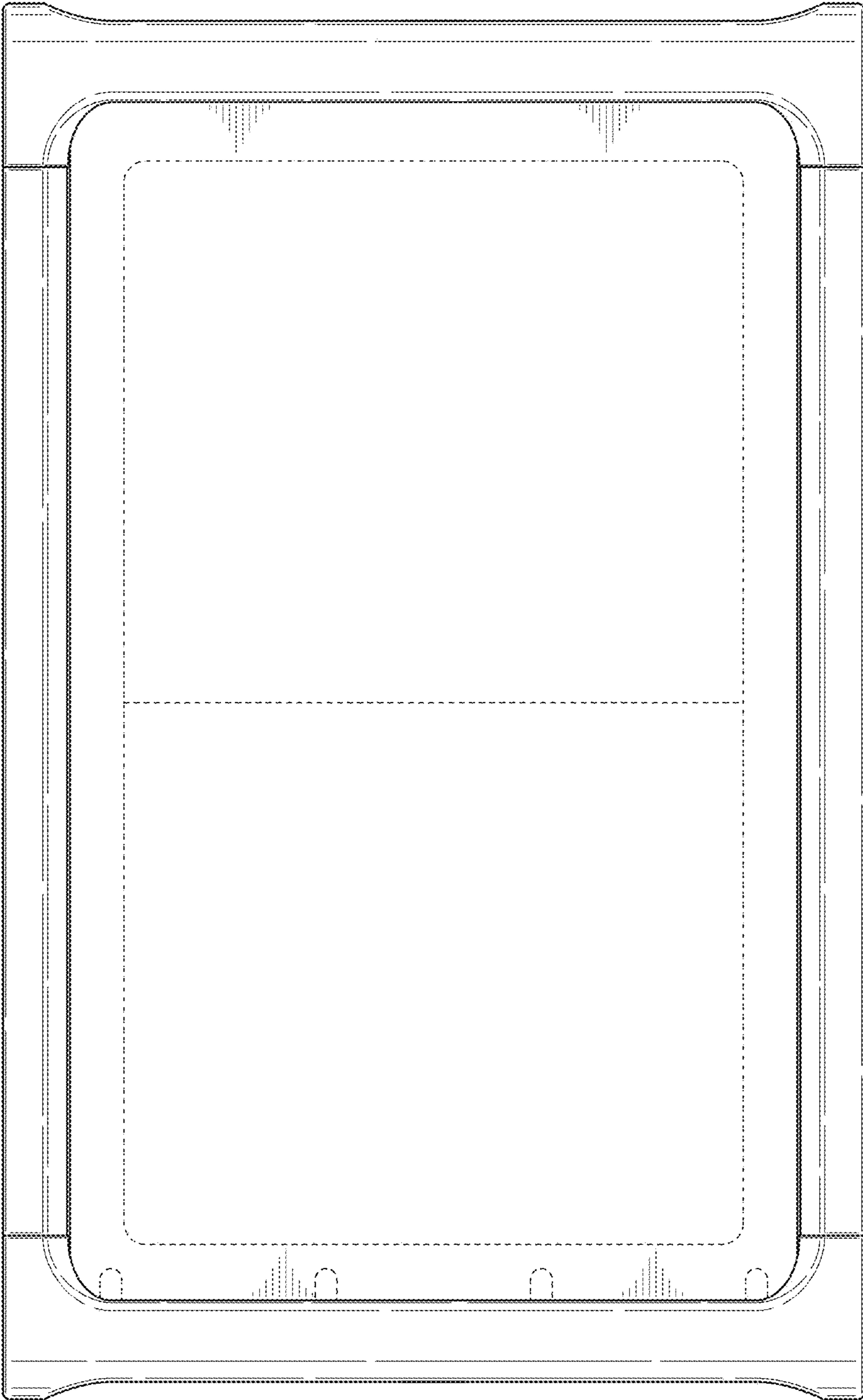

FIG. 4

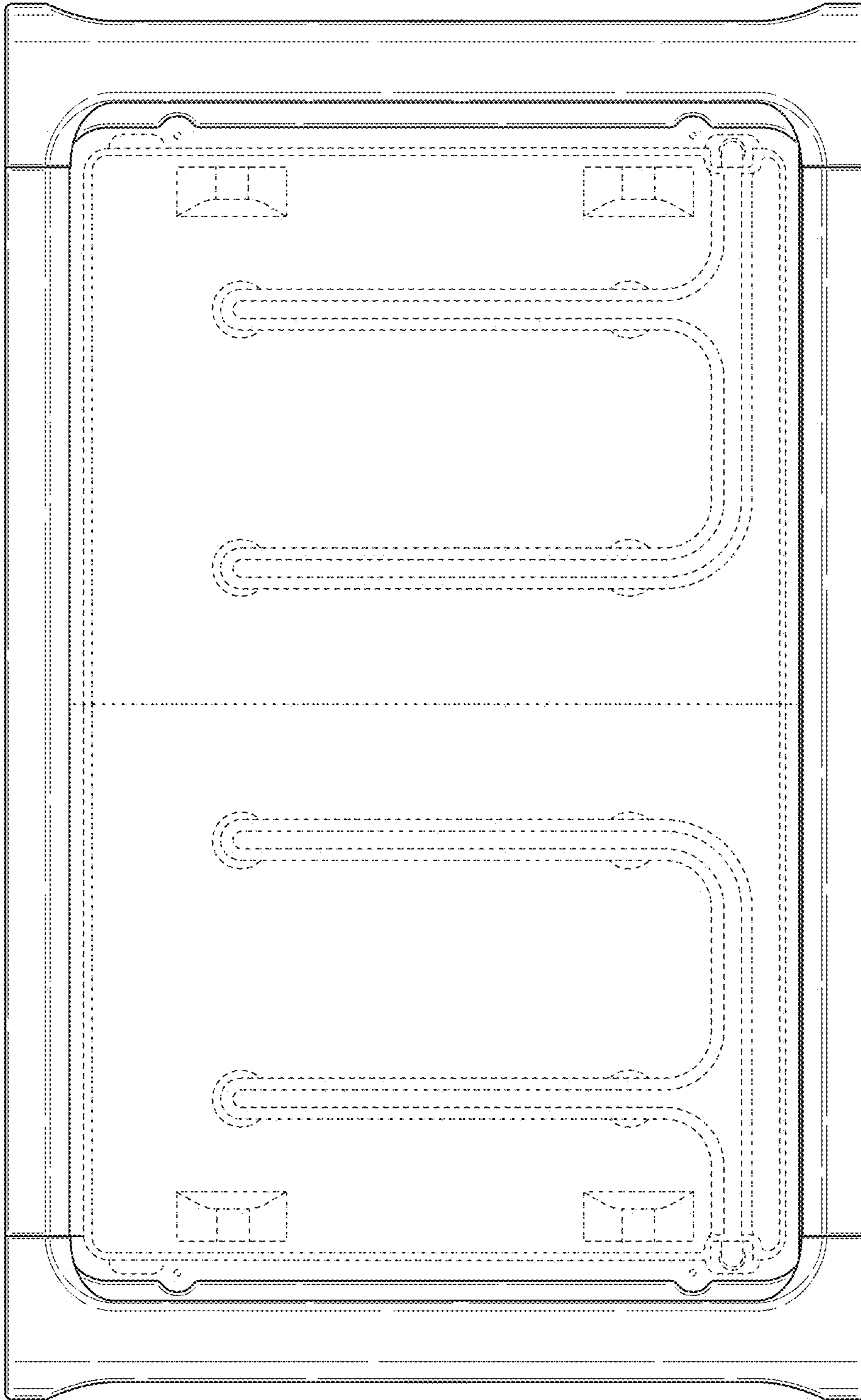

FIG. 5

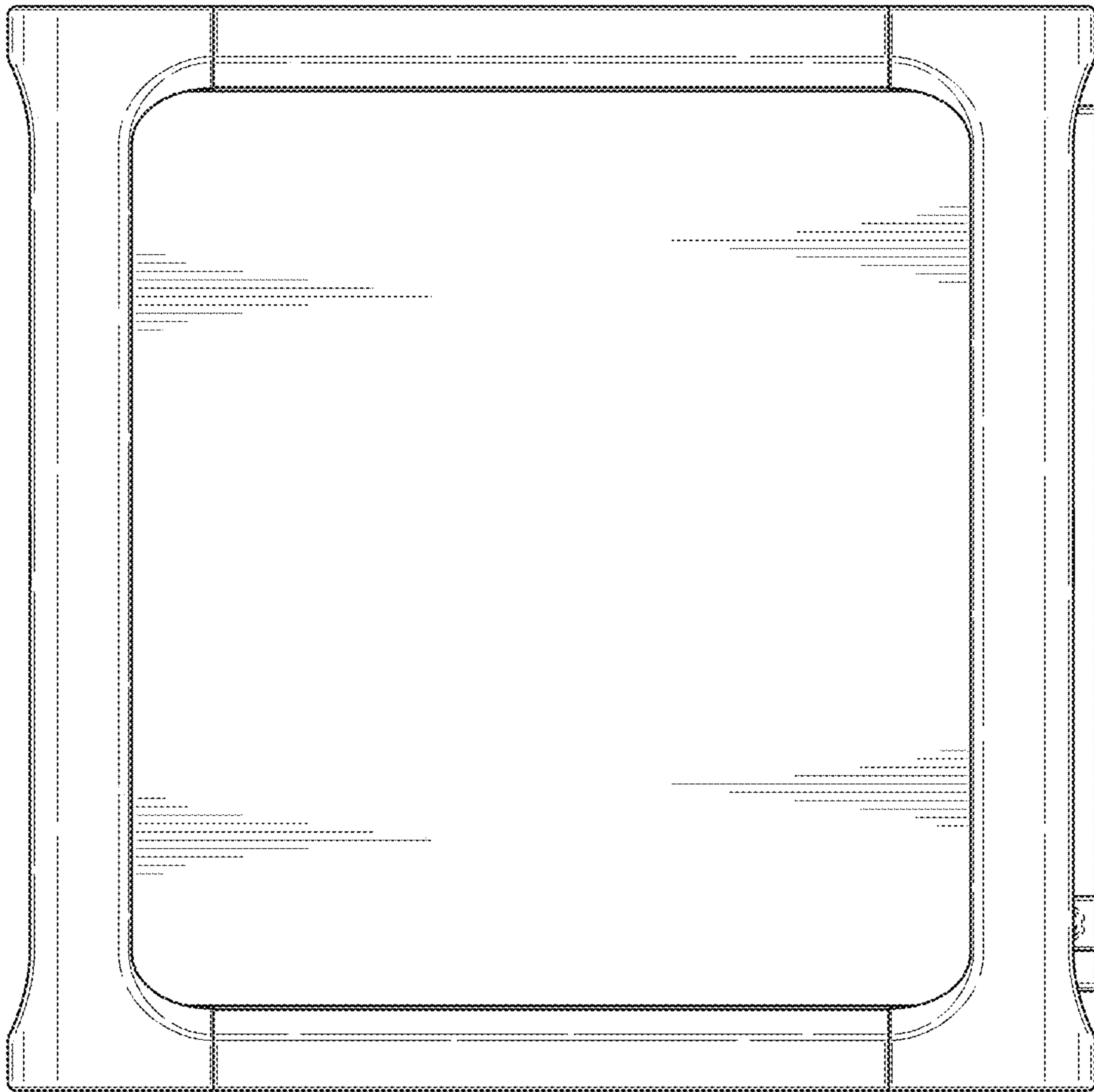

FIG. 6



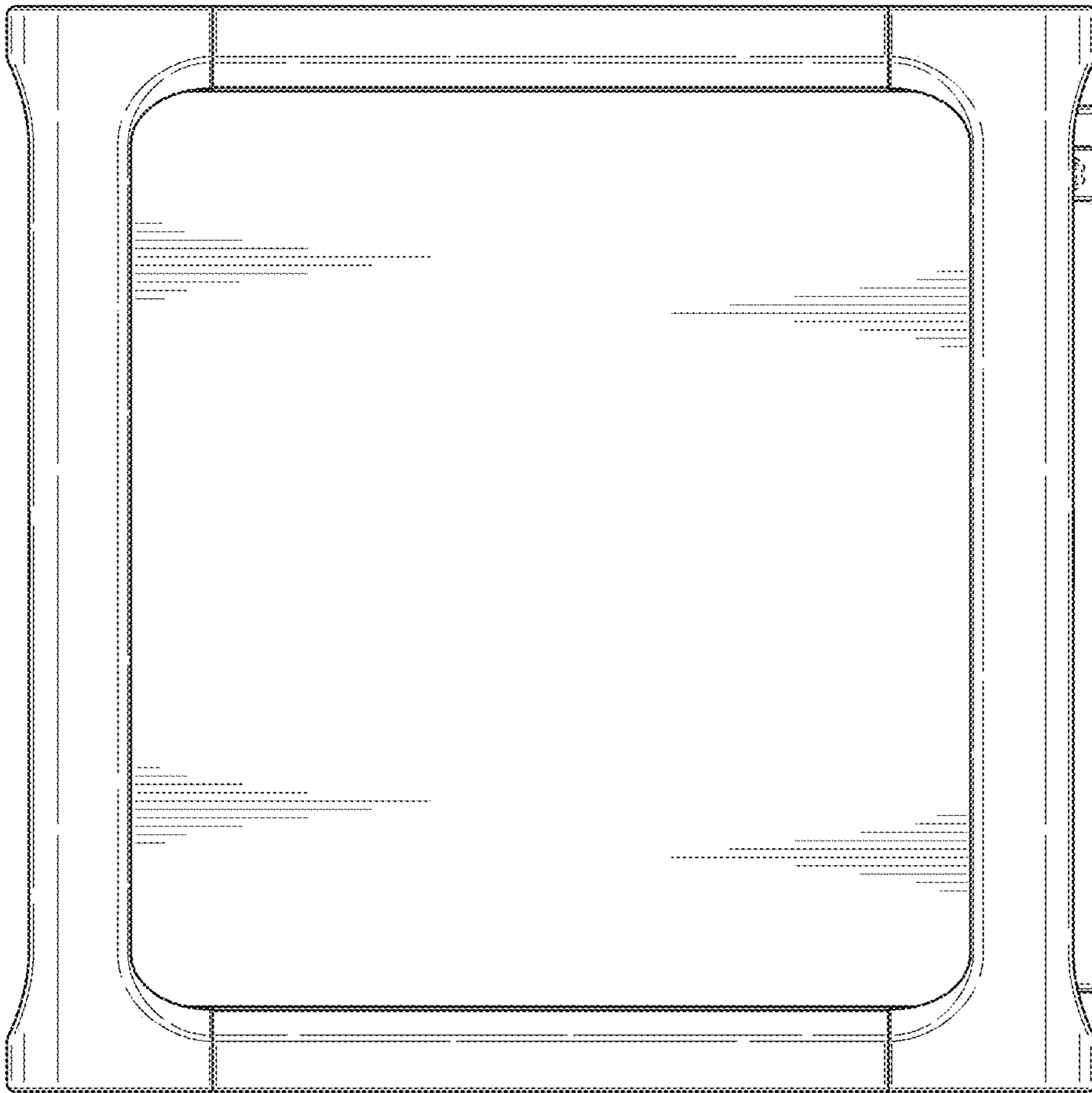

FIG. 7

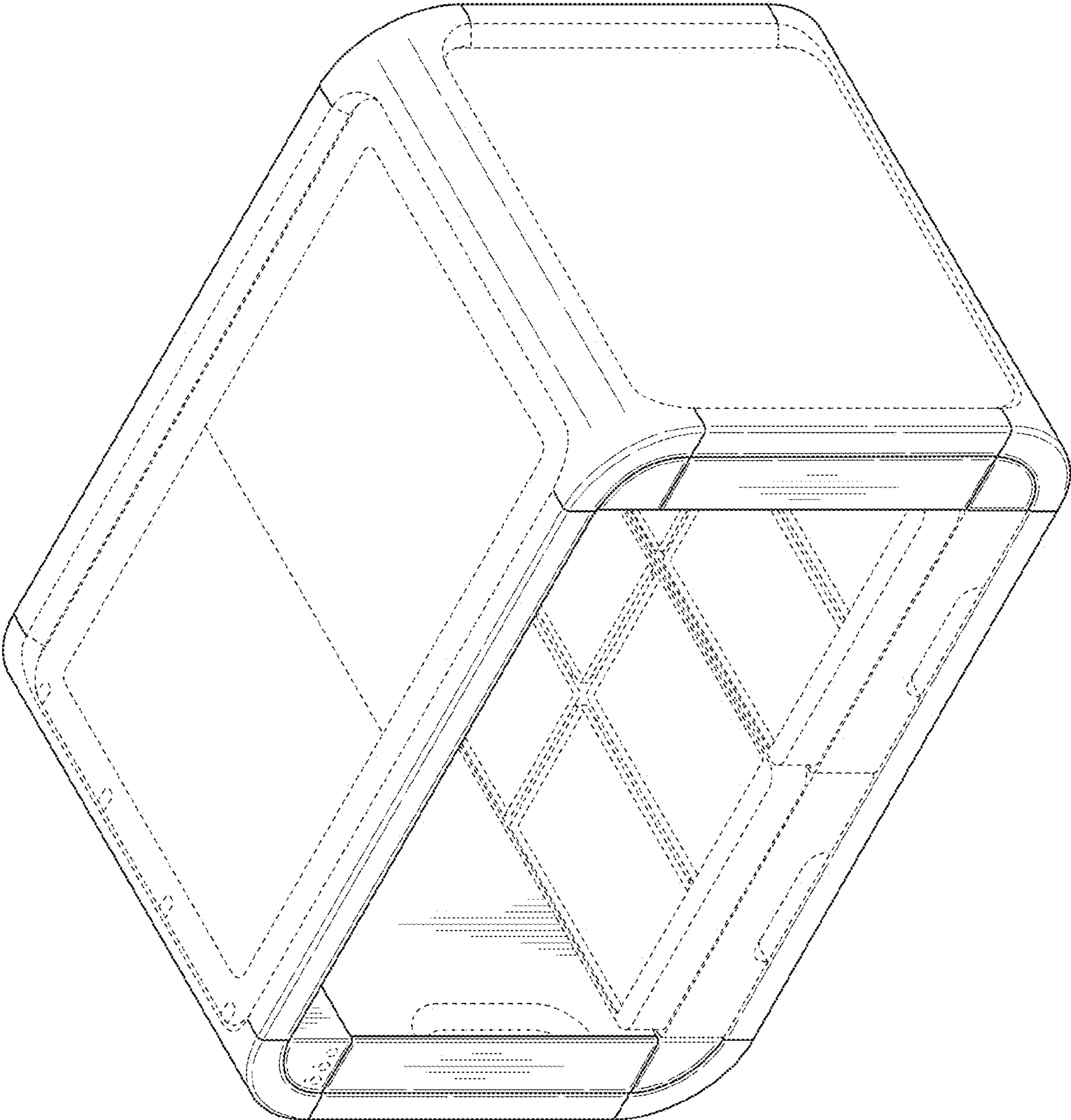

FIG. 8

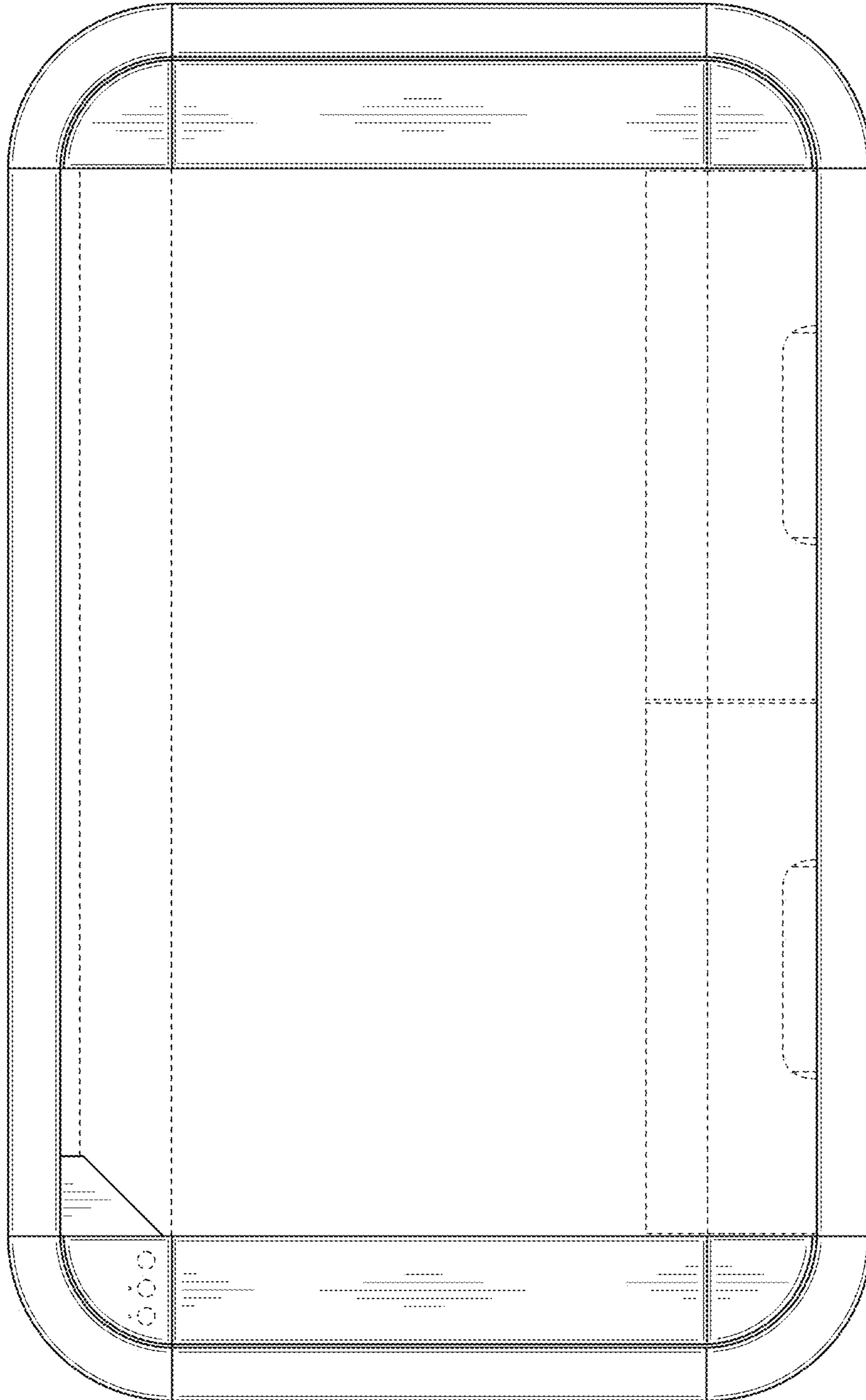

FIG. 9

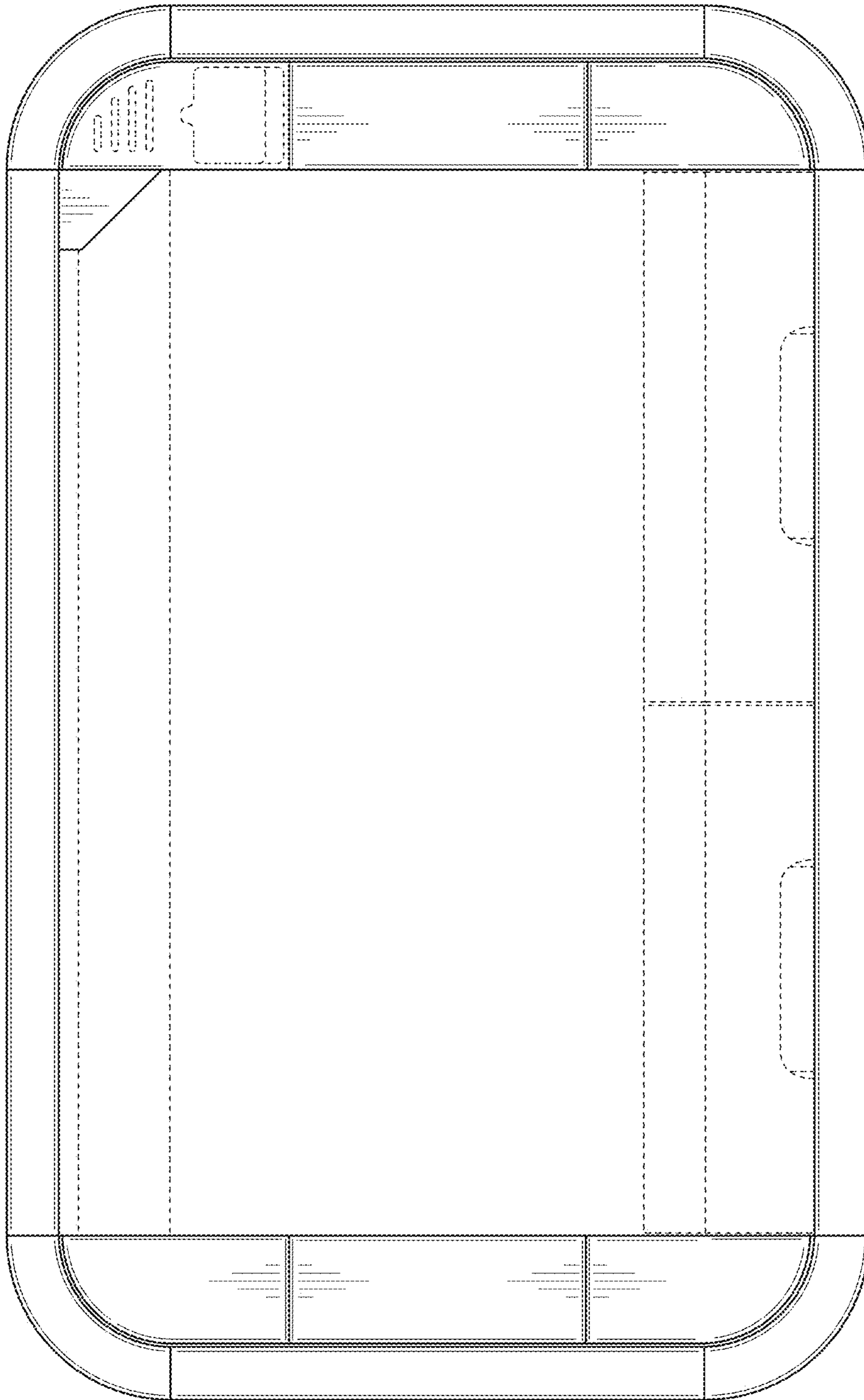

FIG. 10



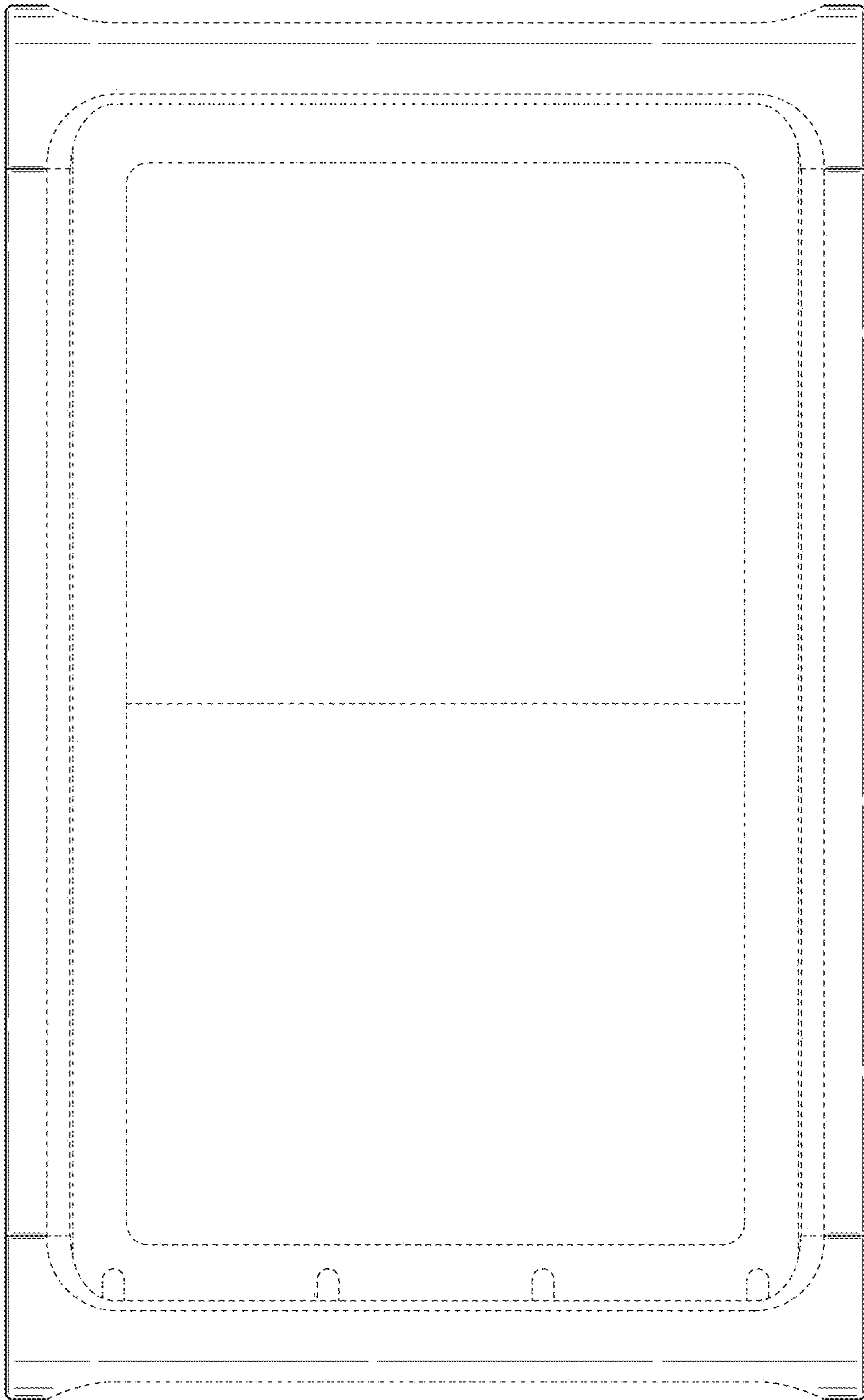

FIG. 11

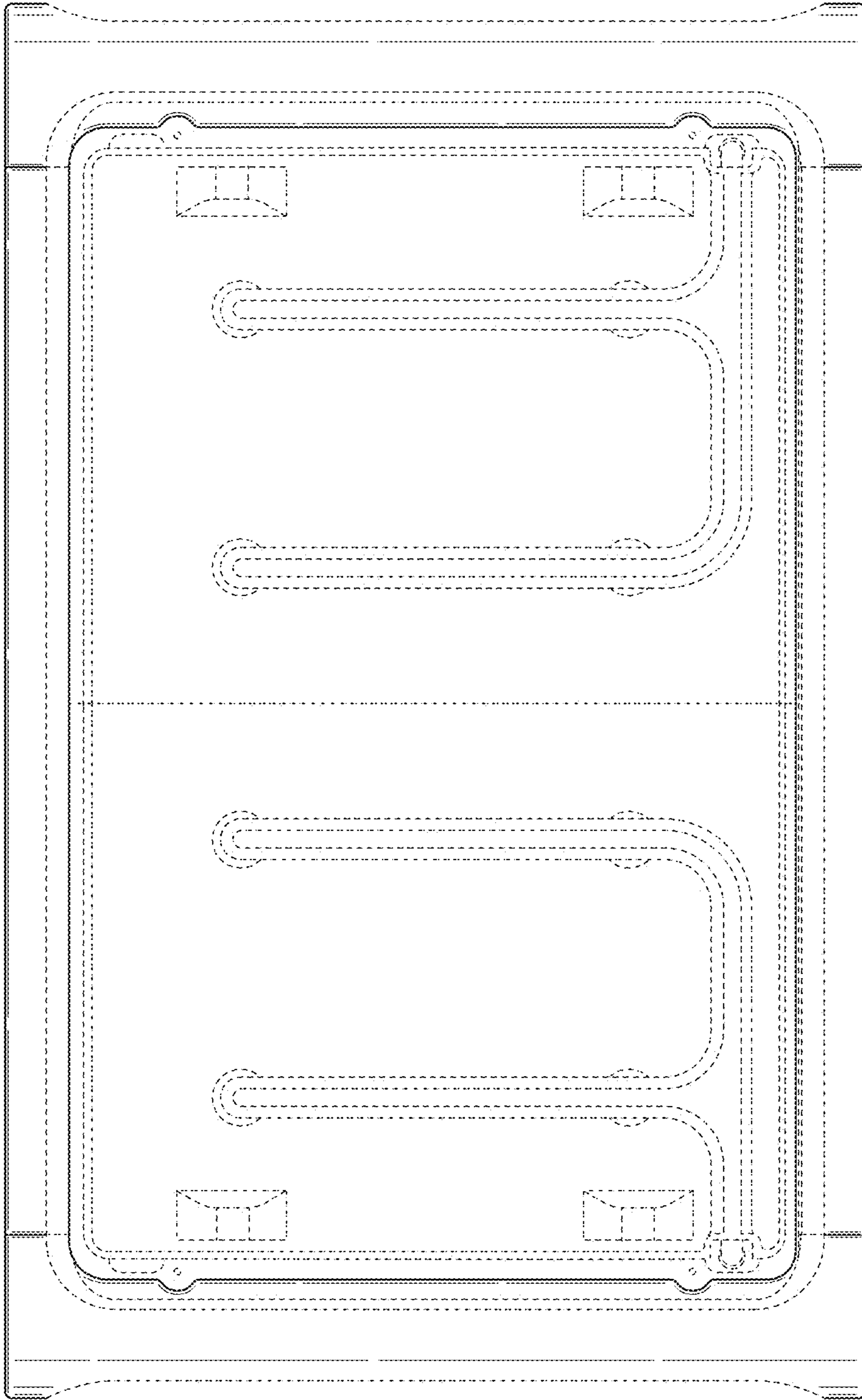

FIG. 12

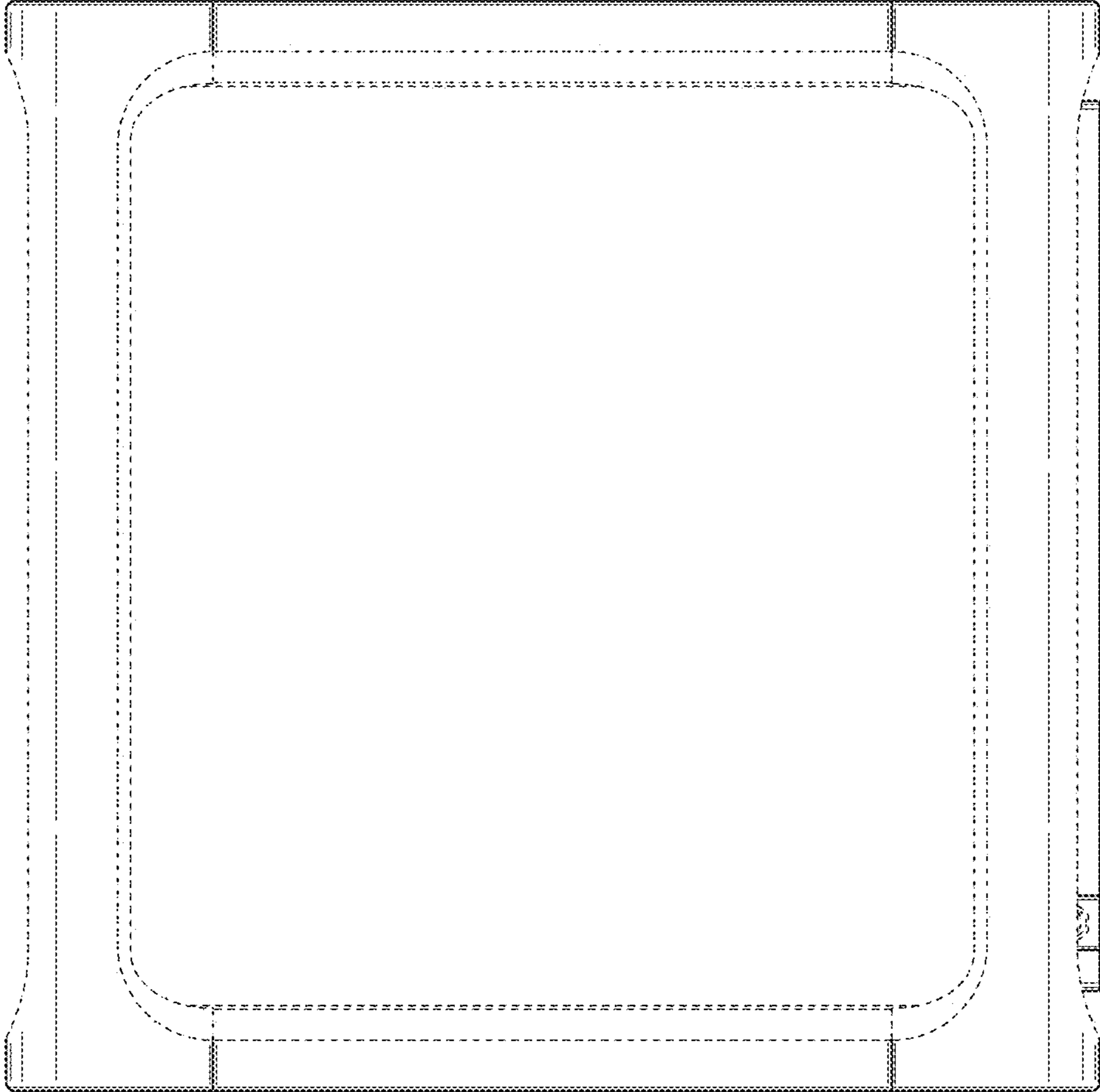
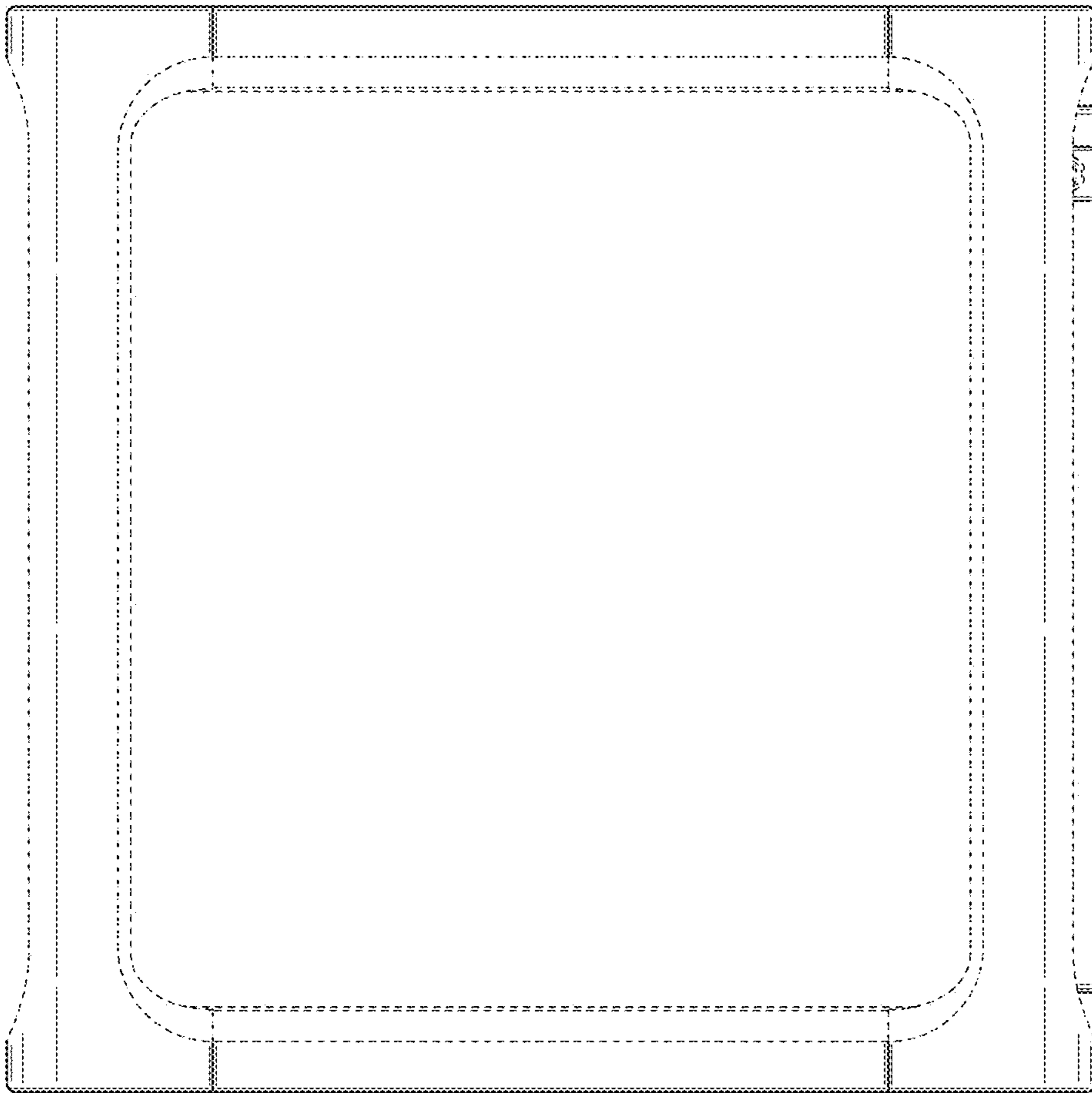

FIG. 13



**FIG. 14**



FIG. 15

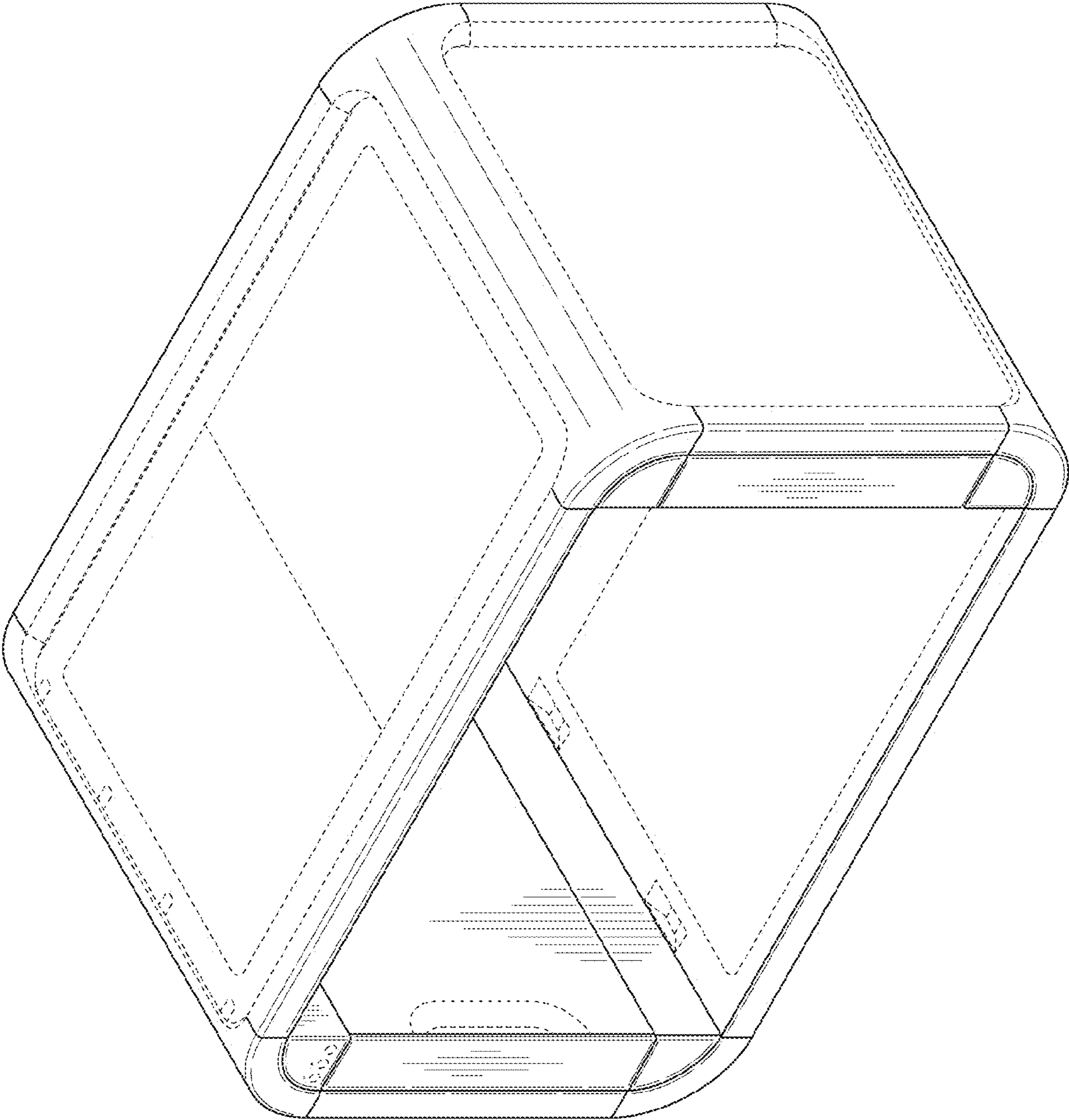

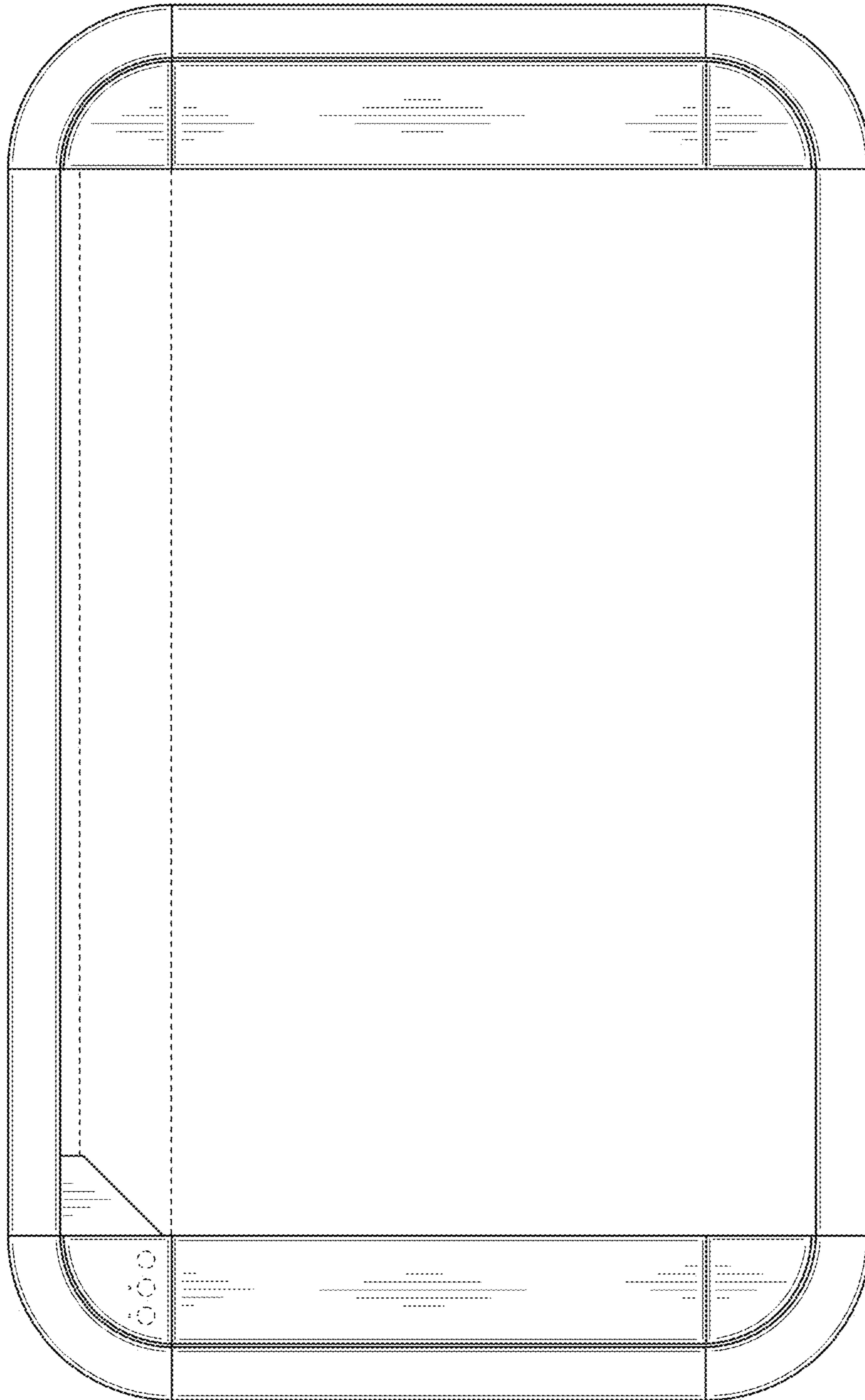

FIG. 16

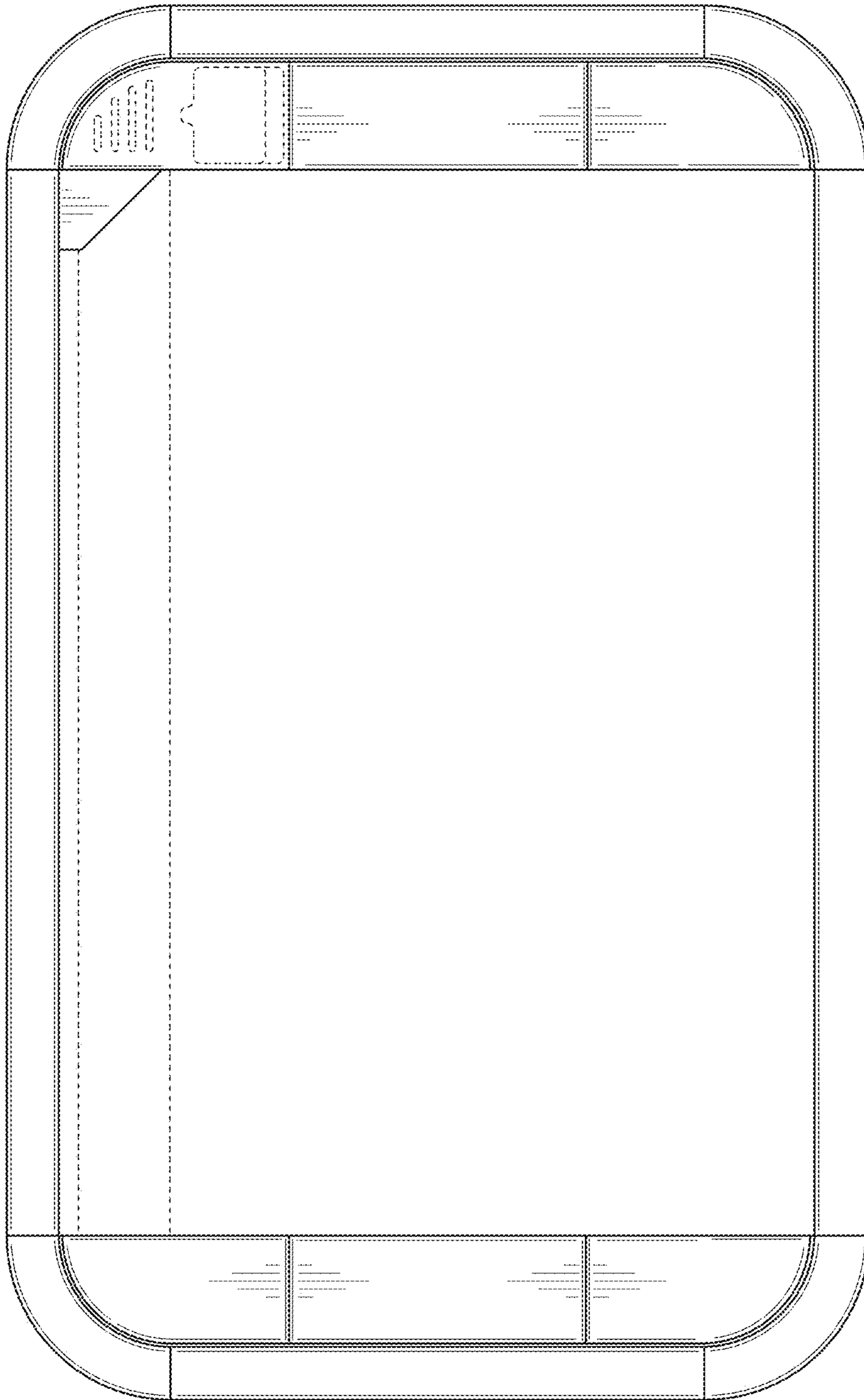

FIG. 17

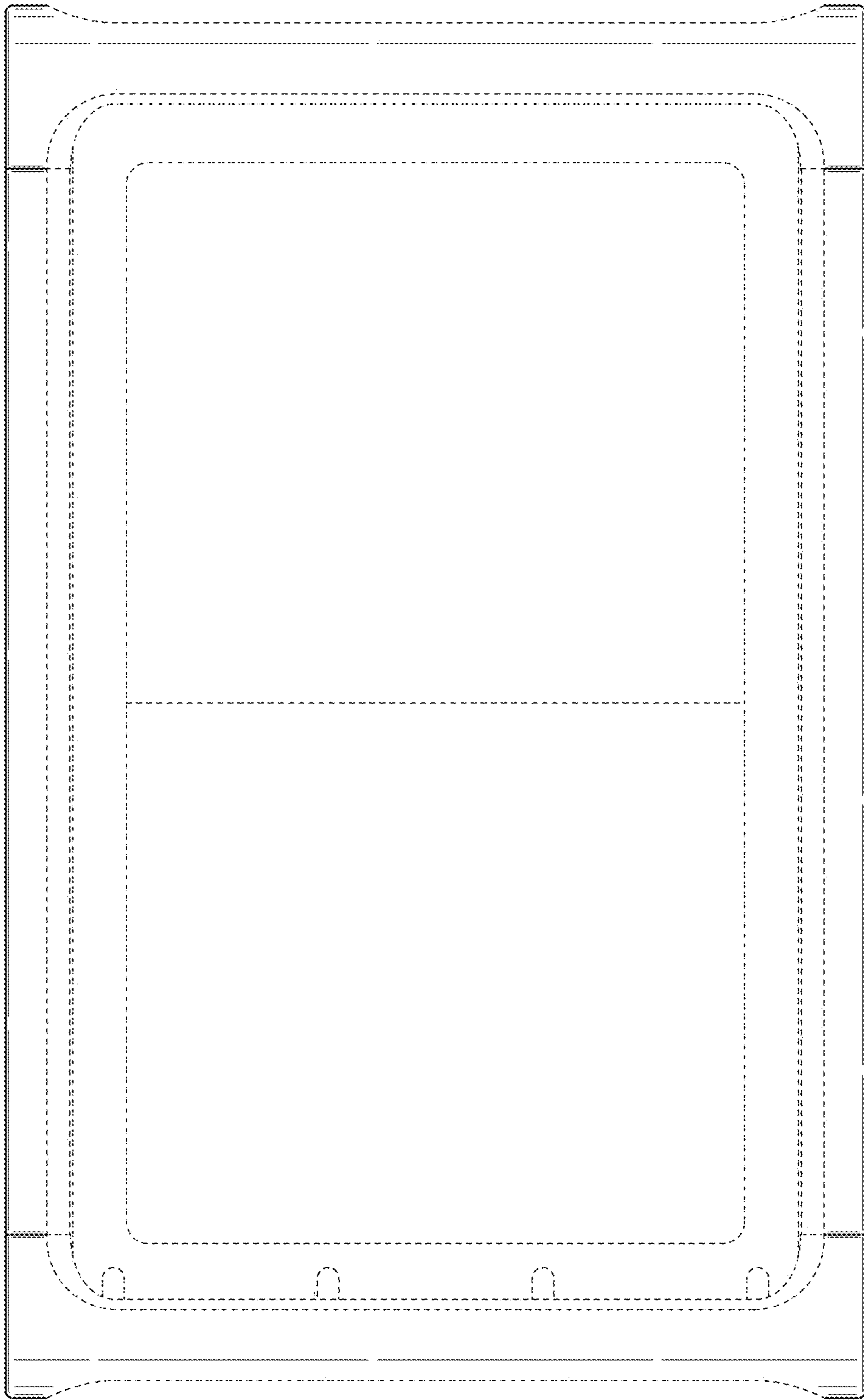

FIG. 18



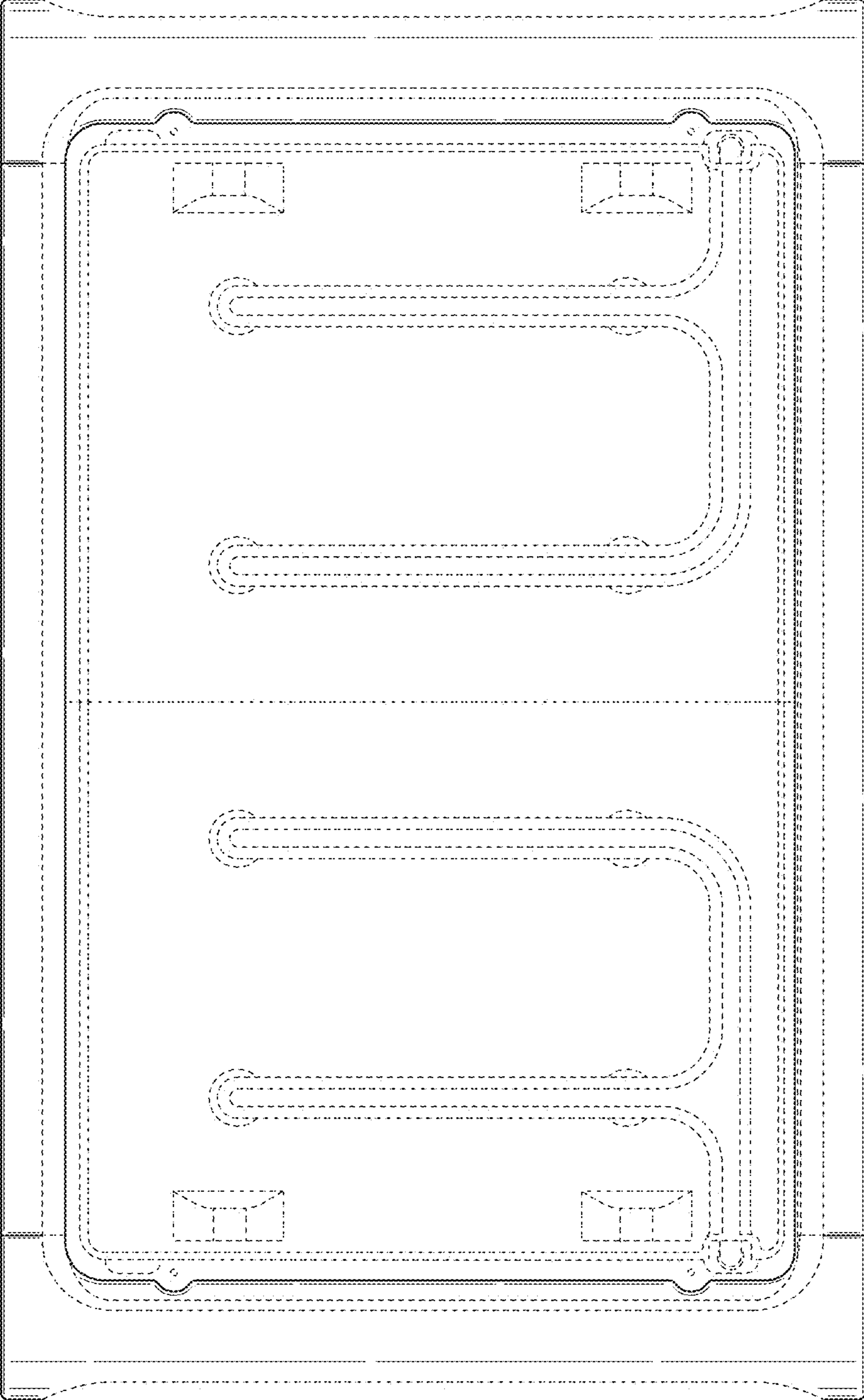

FIG. 19

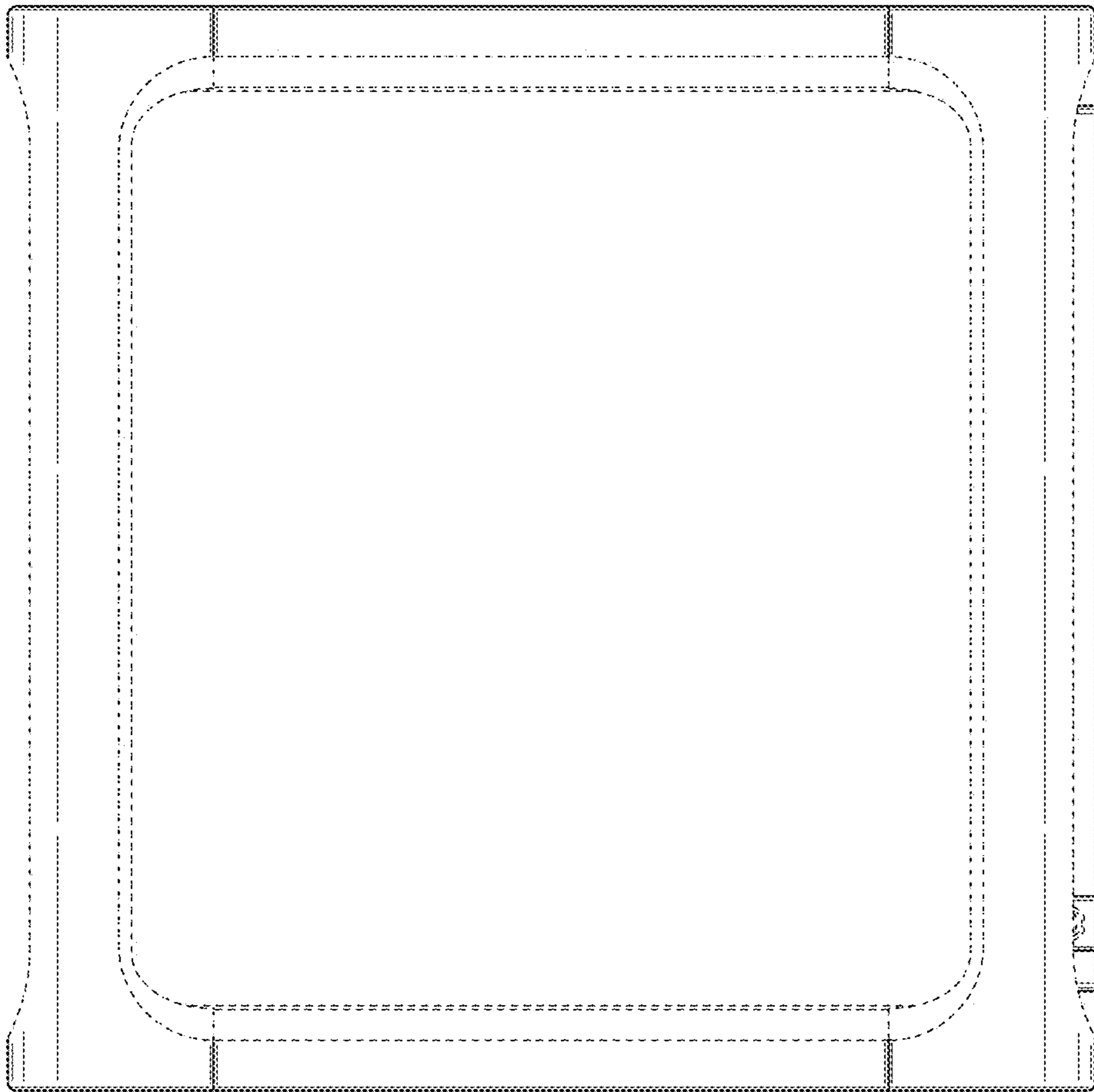

FIG. 20

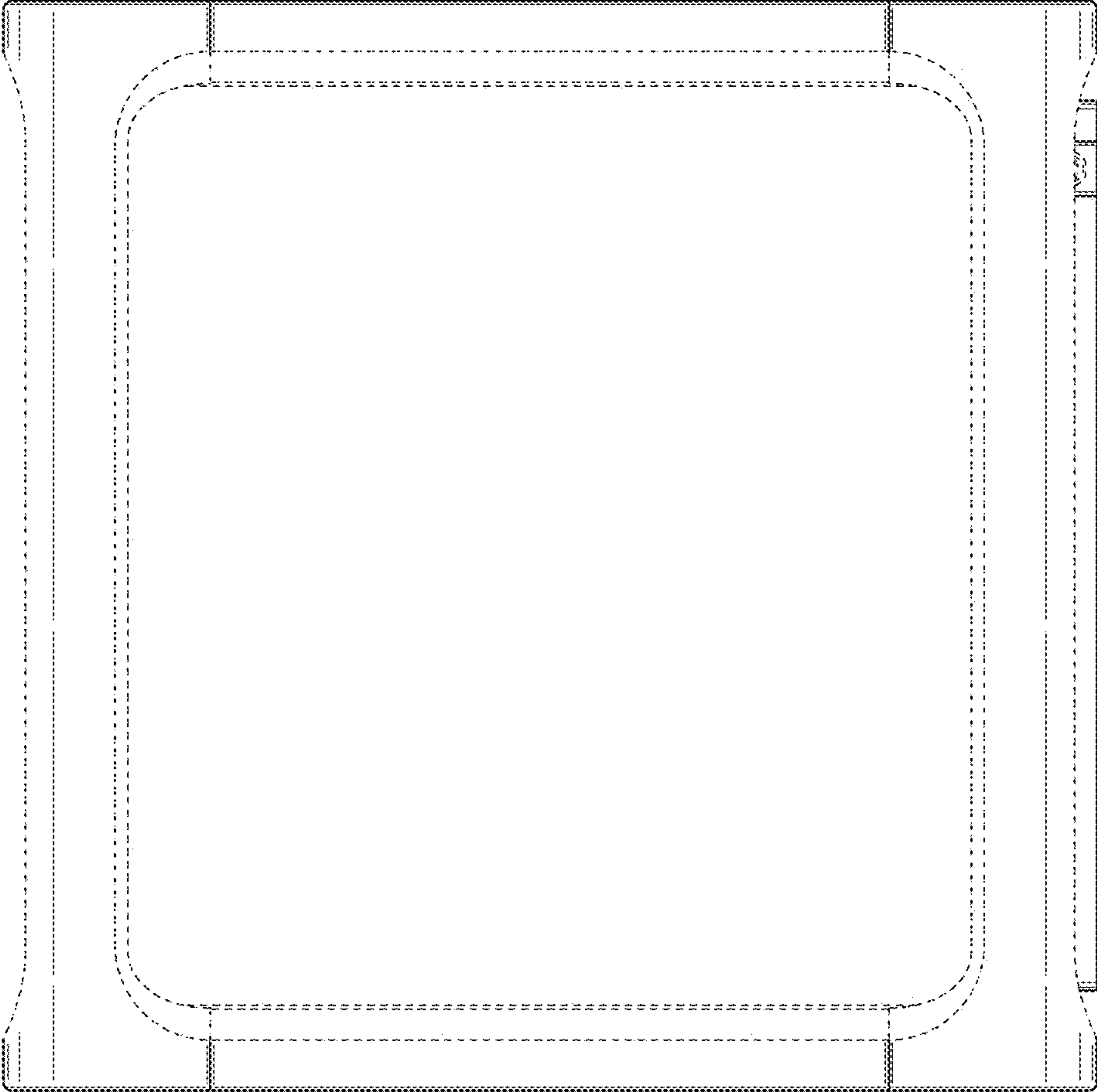

FIG. 21