



US00D887857S

(12) **United States Design Patent** (10) **Patent No.:** **US D887,857 S**  
**Akana et al.** (45) **Date of Patent:** **\*\* Jun. 23, 2020**

(54) **BAG**

(71) Applicant: **Apple Inc.**, Cupertino, CA (US)

(72) Inventors: **Jody Akana**, San Francisco, CA (US); **Molly Anderson**, San Francisco, CA (US); **Bartley K. Andre**, Palo Alto, CA (US); **Shota Aoyagi**, San Francisco, CA (US); **Anthony Michael Ashcroft**, San Francisco, CA (US); **Jeremy Bataillon**, San Francisco, CA (US); **Daniel J. Coster**, San Francisco, CA (US); **Daniele De Iuliis**, San Francisco, CA (US); **M. Evans Hankey**, San Francisco, CA (US); **Julian Hoenig**, San Francisco, CA (US); **Richard P. Howarth**, San Francisco, CA (US); **Jonathan P. Ive**, San Francisco, CA (US); **Duncan Robert Kerr**, San Francisco, CA (US); **Michael Korinek**, San Francisco, CA (US); **Matthew Dean Rohrbach**, San Francisco, CA (US); **Peter Russell-Clarke**, San Francisco, CA (US); **Benjamin Andrew Shaffer**, San Jose, CA (US); **Mikael Silvanto**, San Francisco, CA (US); **Christopher J. Stringer**, Woodside, CA (US); **Clement Tissandier**, San Francisco, CA (US); **Eugene Antony Whang**, San Francisco, CA (US); **Rico Zörkendörfer**, San Francisco, CA (US)

(73) Assignee: **Apple Inc.**, Cupertino, CA (US)

(\*\*) Term: **15 Years**

(21) Appl. No.: **29/674,579**

(22) Filed: **Dec. 21, 2018**

**Related U.S. Application Data**

(63) Continuation of application No. 29/641,663, filed on Mar. 23, 2018, now Pat. No. Des. 838,605, which is (Continued)

(51) **LOC (12) Cl.** ..... **09-05**

(52) **U.S. Cl.**

USPC ..... **D9/703**

(58) **Field of Classification Search**

USPC ..... D9/702-714, 719, 738-740, 517-518, D9/522, 416, 435, 444, 460, 455, 414, (Continued)

(56) **References Cited**

**U.S. PATENT DOCUMENTS**

D254,478 S 3/1980 Carroll  
D343,288 S 1/1994 Chao  
(Continued)

**FOREIGN PATENT DOCUMENTS**

DE D40102866-0001 10/2001  
DE D40102866-0002 10/2001  
JP D1020379 S 9/1998

*Primary Examiner* — Abraham Bahta

(74) *Attorney, Agent, or Firm* — Sterne, Kessler, Goldstein & Fox P.L.L.C.

(57) **CLAIM**

The ornamental design for a bag, as shown and described.

**DESCRIPTION**

FIG. 1 is a top front perspective view of a bag showing the claimed design;

FIG. 2 is a front view thereof;

FIG. 3 is a rear view thereof;

FIG. 4 is a left side view thereof;

FIG. 5 is a right side view thereof;

FIG. 6 is a top view thereof;

FIG. 7 is a bottom view thereof;

FIG. 8 is a reference cross-sectional view taken along line 8-8 in FIG. 5 with handles removed;

FIG. 9 is a reference perspective view showing the bag of FIG. 1 with handles in another state;

FIG. 10 is a top front perspective view of another bag showing the claimed design;

FIG. 11 is a front view thereof;

(Continued)

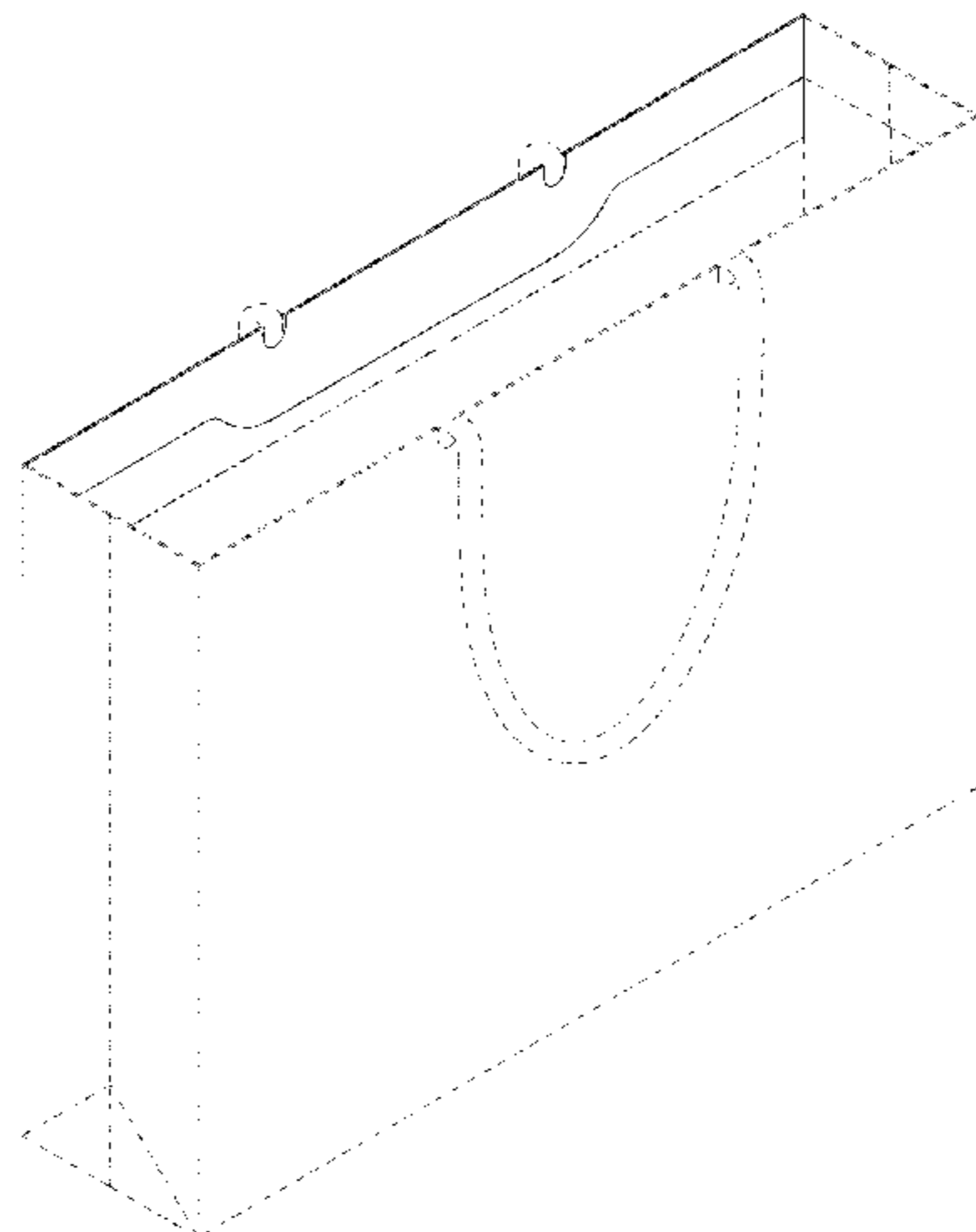

FIG. 12 is a rear view thereof;  
 FIG. 13 is a left side view thereof;  
 FIG. 14 is a right side view thereof;  
 FIG. 15 is a top view thereof;  
 FIG. 16 is a bottom view thereof;  
 FIG. 17 is a reference cross-sectional view taken along line 17-17 in FIG. 14 with handles removed; and,  
 FIG. 18 is a reference perspective view showing the bag of FIG. 10 with handles in another state.  
 The dashed broken lines in the figures show portions of the bag that form no part of the claimed design.  
 The dot-dash broken lines in the figures show boundaries that form no part of the claimed design.

**1 Claim, 16 Drawing Sheets**

**Related U.S. Application Data**

a continuation of application No. 29/571,249, filed on Jul. 15, 2016, now Pat. No. Des. 813,685, which is a continuation of application No. 29/519,818, filed on Mar. 9, 2015, now Pat. No. Des. 764,939.

(58) **Field of Classification Search**

USPC ..... D9/499, 431-432; D7/560-562; 206/434, 426-427, 429-430, 485, 485.1,

206/499, 508, 431, 418-422, 588-594;  
 229/117.3, 185, 121, 122, 200, 207, 236,  
 229/87.01; 220/23.83; 150/100-118;  
 294/137, 152; 383/6, 10, 14, 20, 40, 33,  
 383/104-105, 117, 108, 120, 93, 121.1,  
 383/127; 428/34.3  
 CPC ..... B65D 33/00; B65D 33/06; B65D 33/065;  
 B65D 33/14; B65D 33/1683; B65D  
 33/12; B65D 31/00; B65D 31/04; B65D  
 31/10

See application file for complete search history.

(56)

**References Cited**

U.S. PATENT DOCUMENTS

|           |    |          |              |        |
|-----------|----|----------|--------------|--------|
| D490,301  | S  | 5/2004   | Townsend     |        |
| D494,058  | S  | 8/2004   | Clark        |        |
| D494,853  | S  | 8/2004   | Chan         |        |
| D497,541  | S  | 10/2004  | Clark        |        |
| D498,667  | S  | 11/2004  | Clark        |        |
| D522,379  | S  | 6/2006   | Clark        |        |
| D548,107  | S  | 8/2007   | Glass        |        |
| D578,409  | S  | 10/2008  | Clark        |        |
| 8,474,163 | B2 | 7/2013   | Rubin        |        |
| D764,939  | S  | 8/2016   | Akana et al. |        |
| D785,463  | S  | 5/2017   | Akana et al. |        |
| D838,605  | S  | * 1/2019 | Akana .....  | D9/703 |

\* cited by examiner

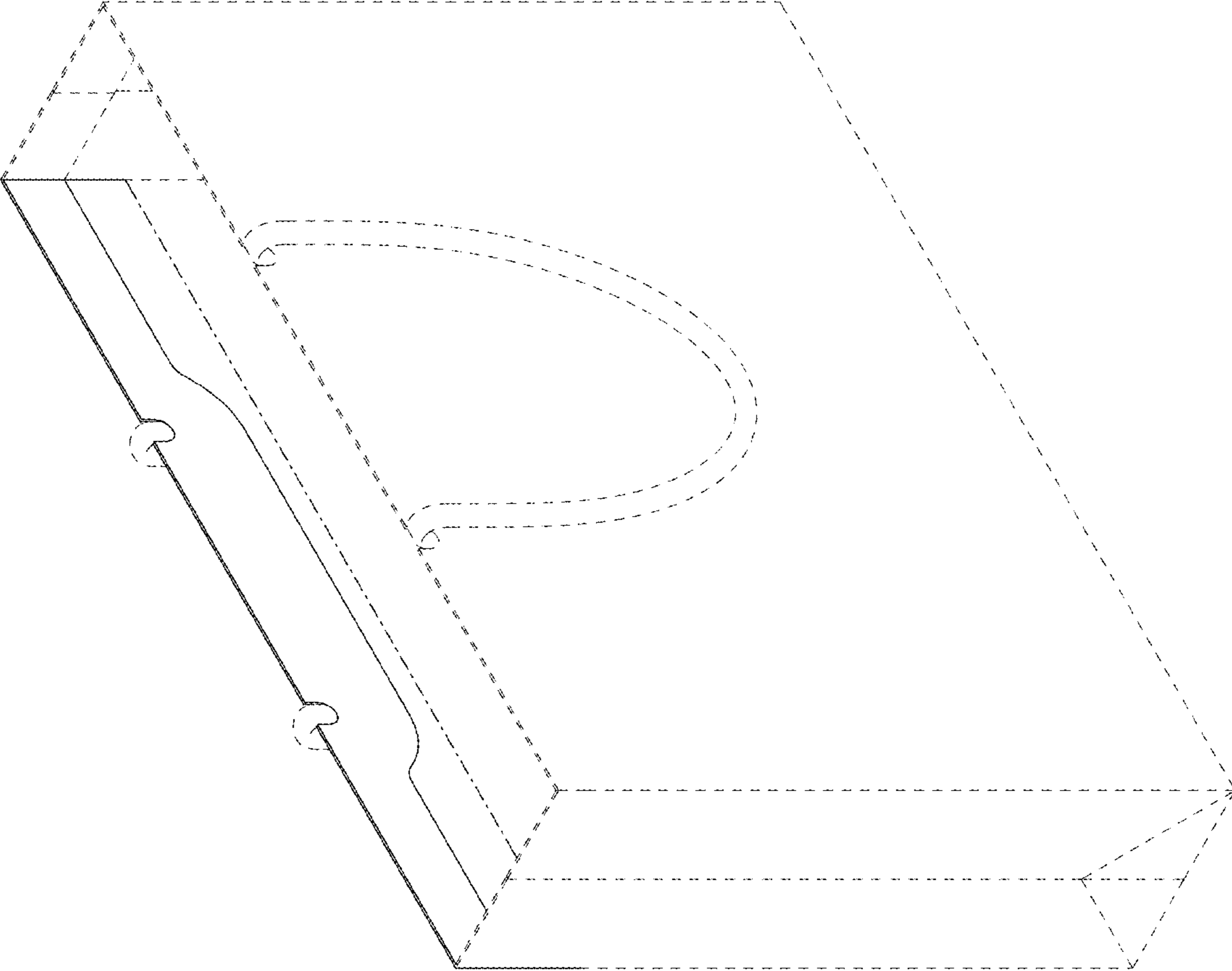

**FIG. 1**

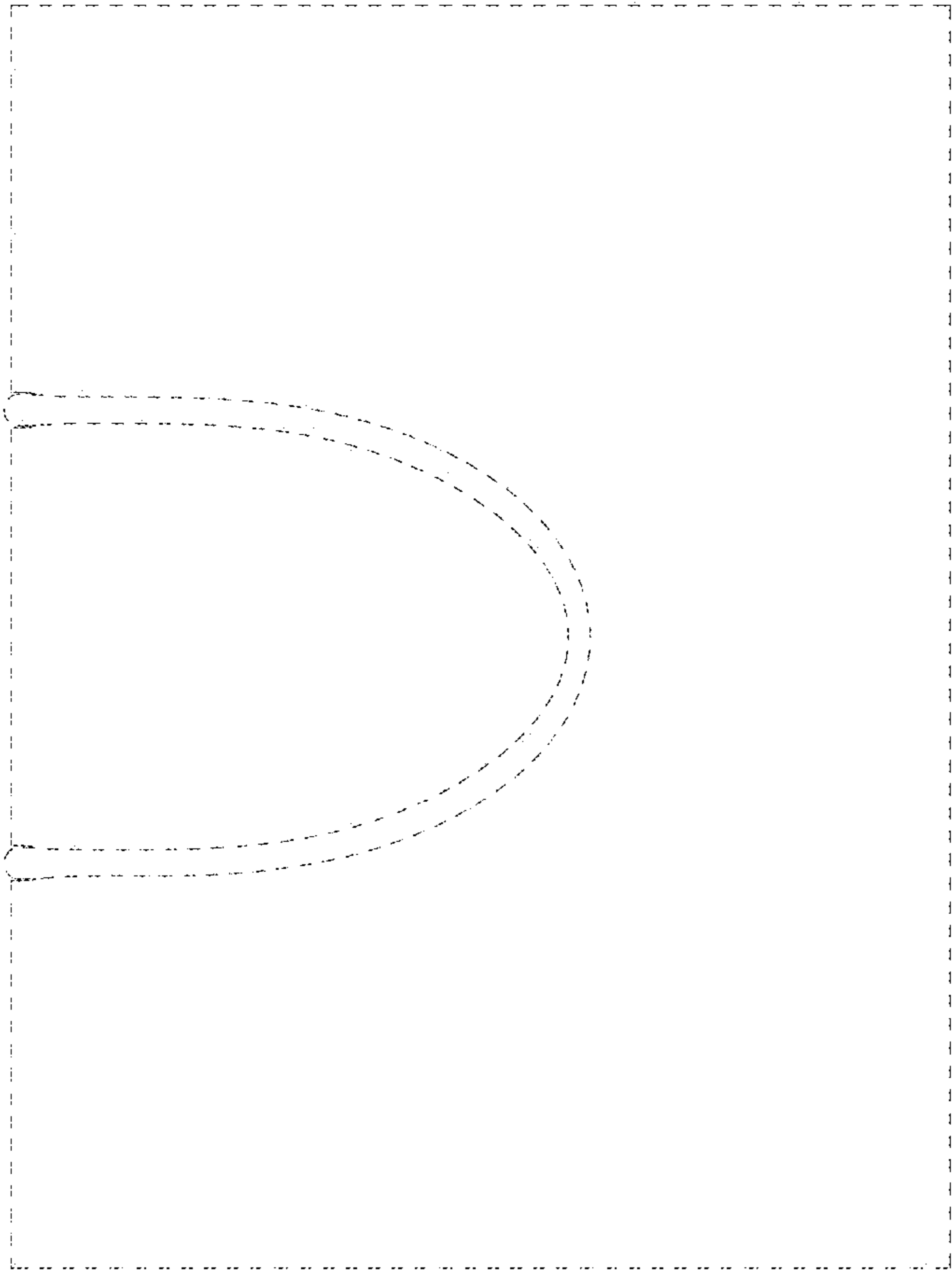

FIG. 2

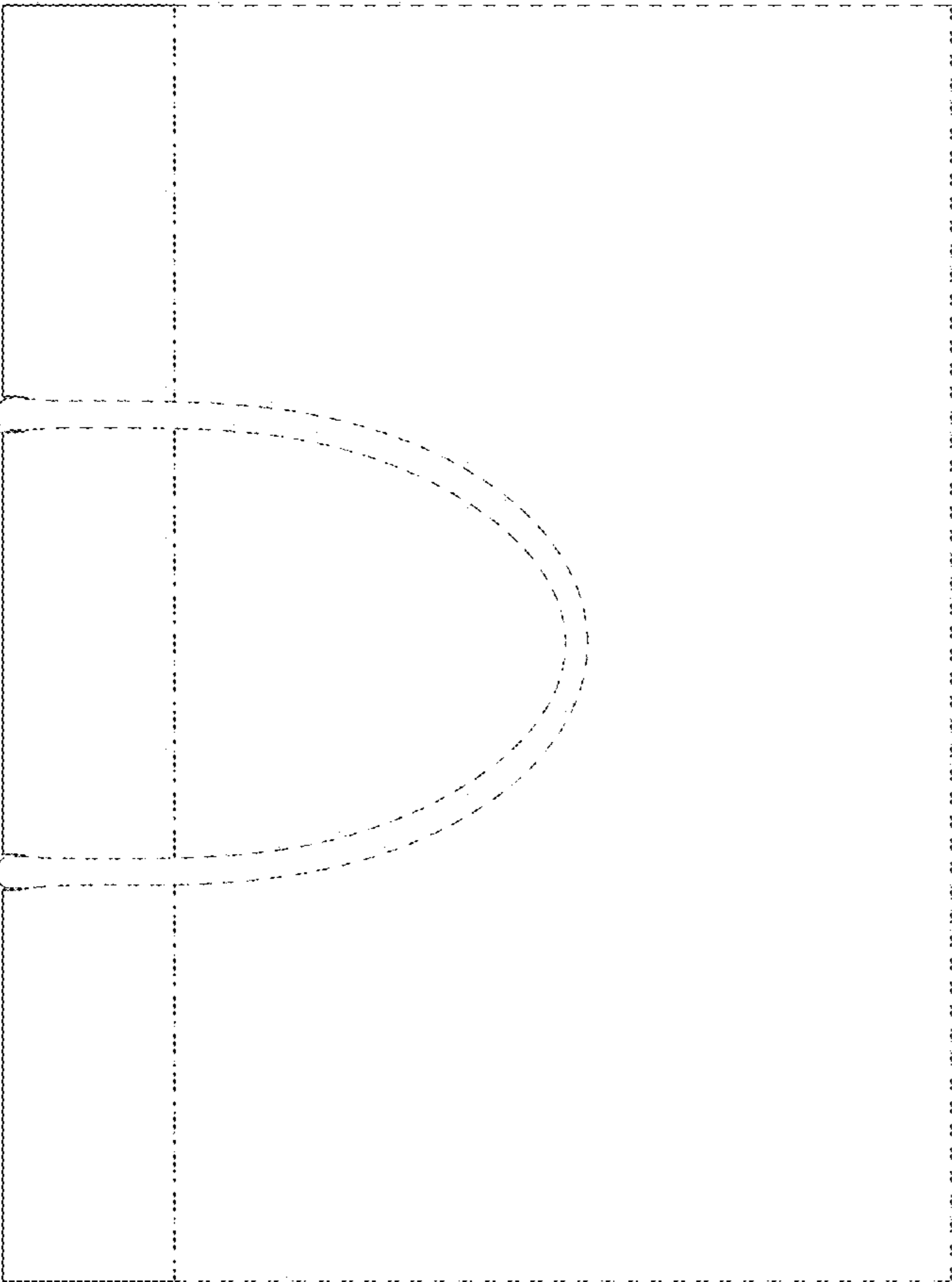

FIG. 3

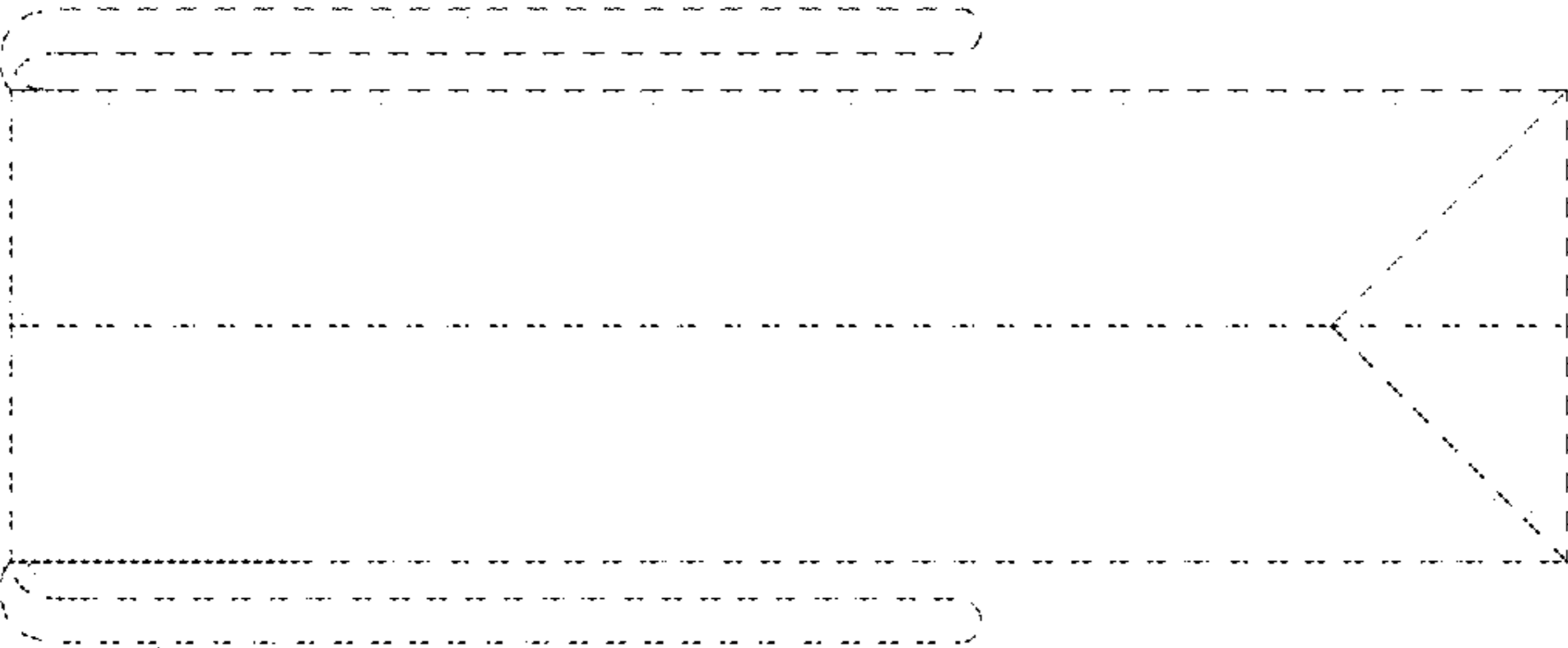
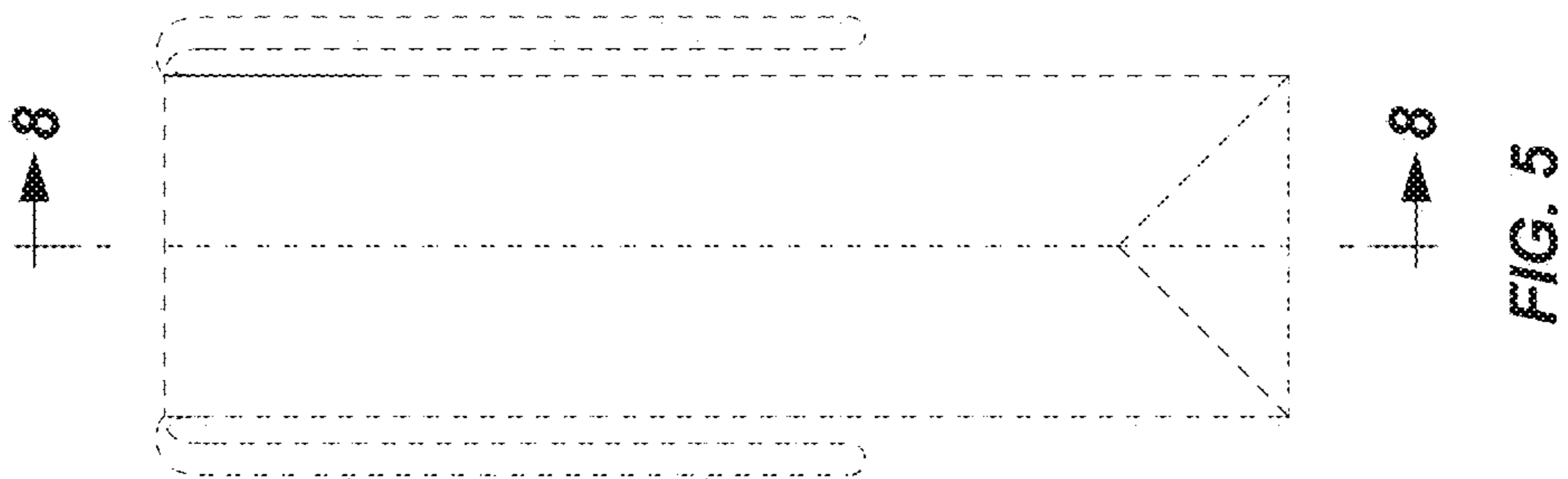

FIG. 4



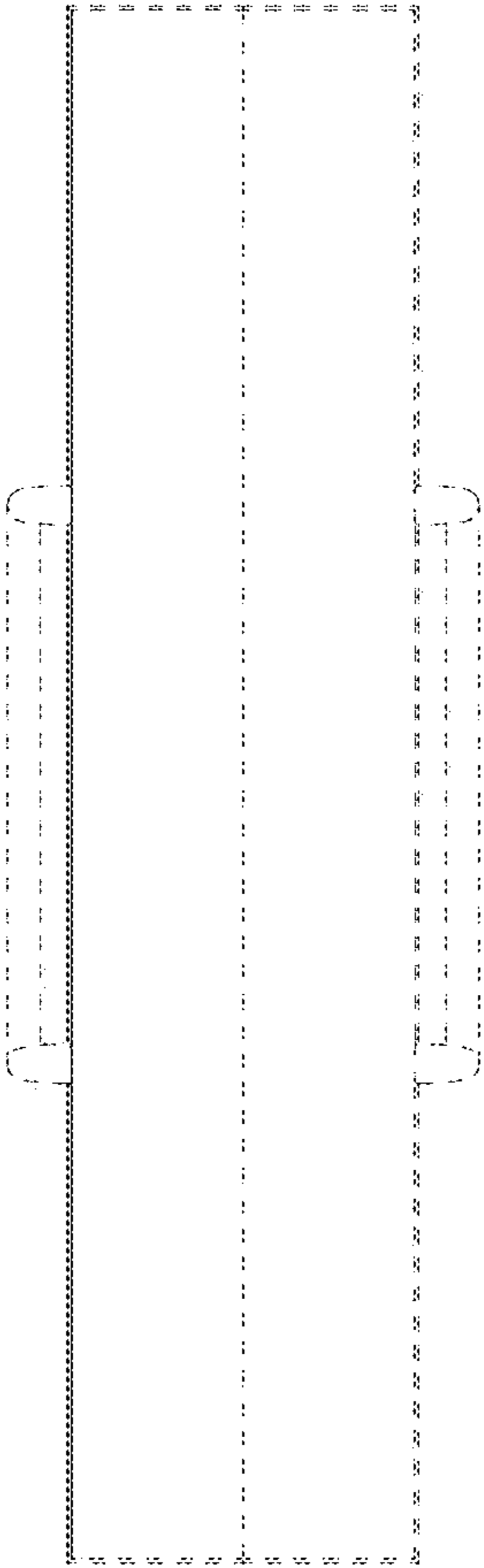

FIG. 6

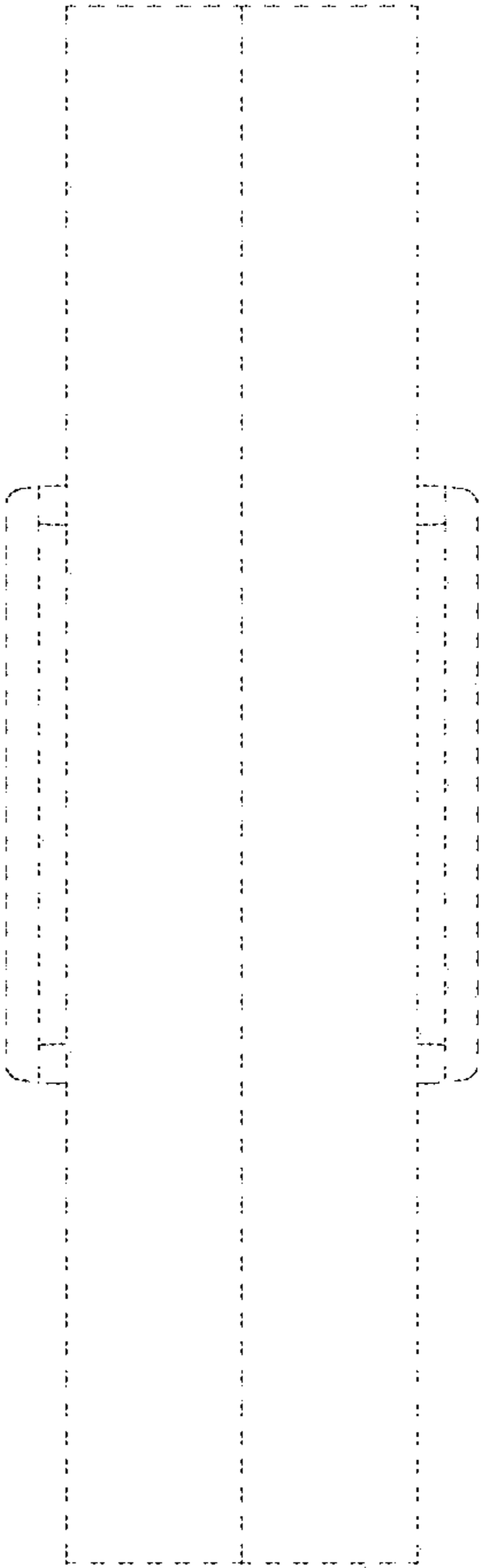

FIG. 7



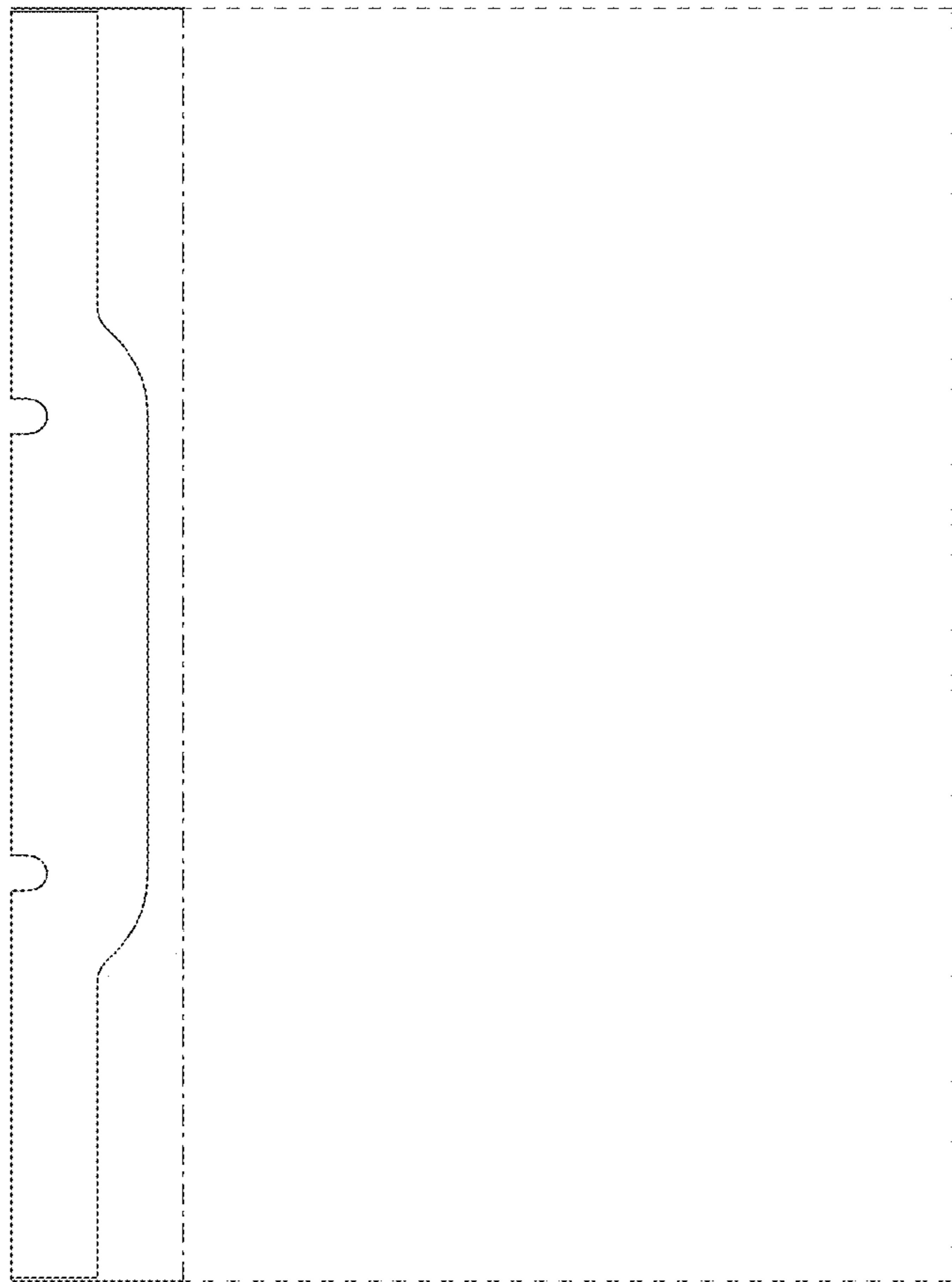

FIG. 8

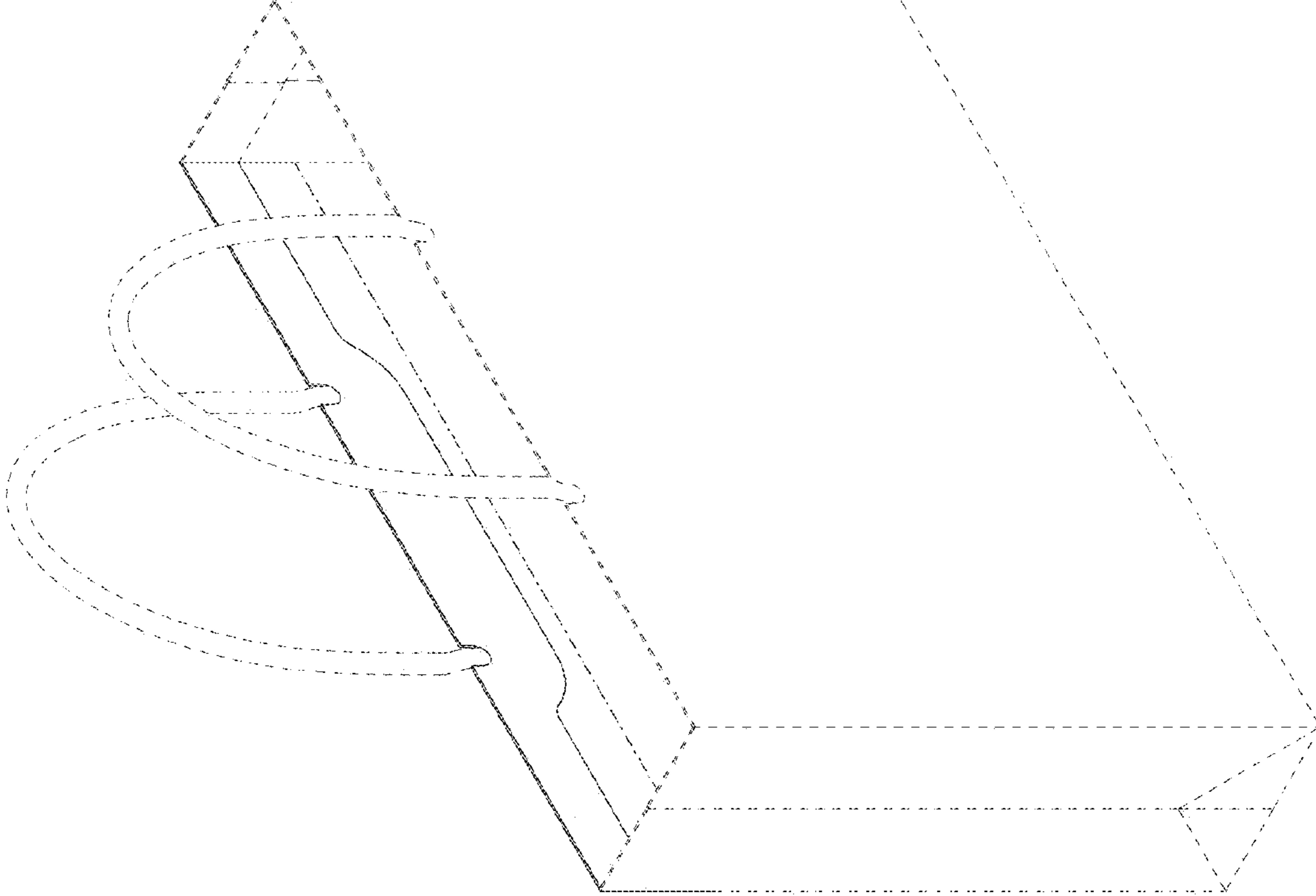

FIG. 9

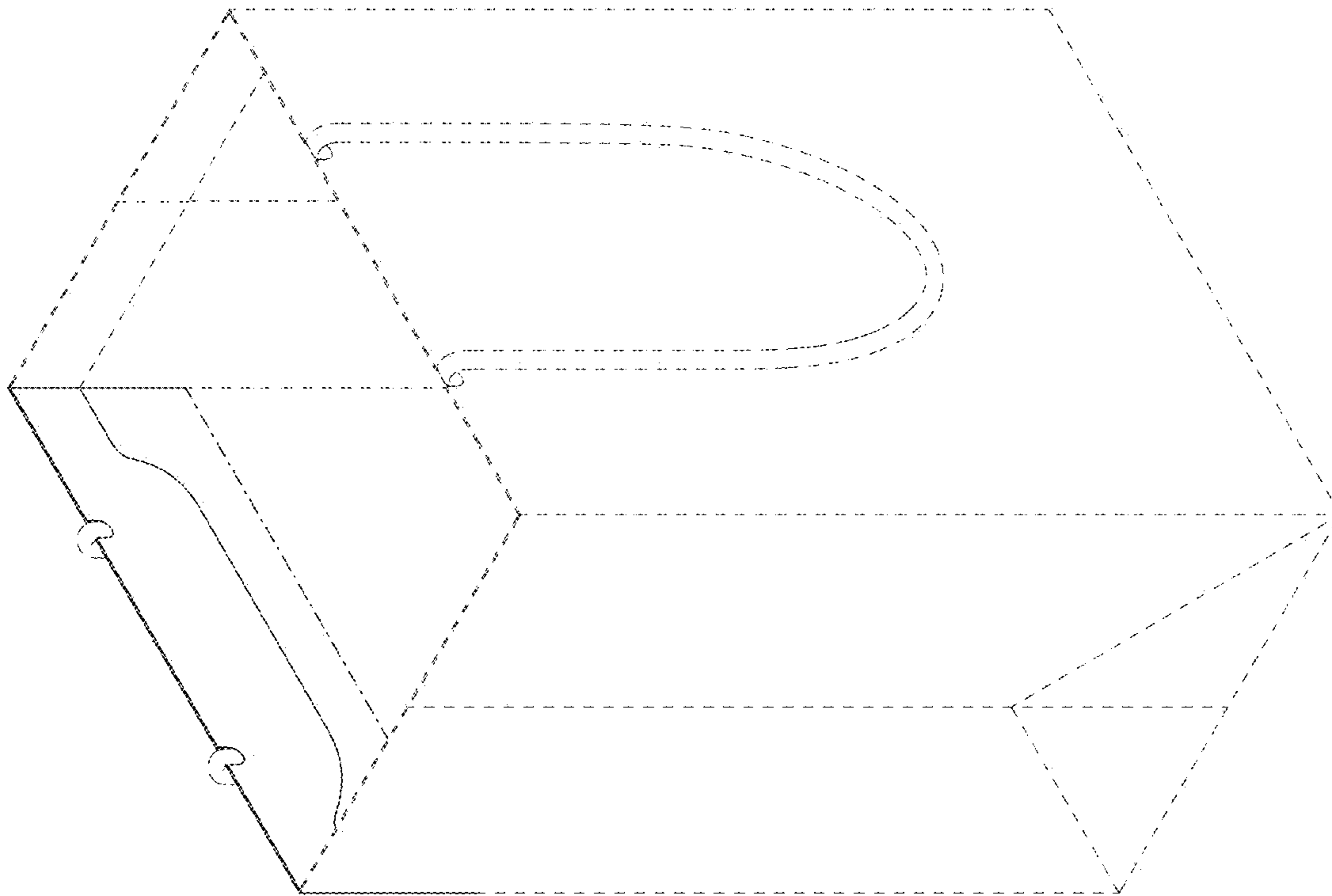

FIG. 10

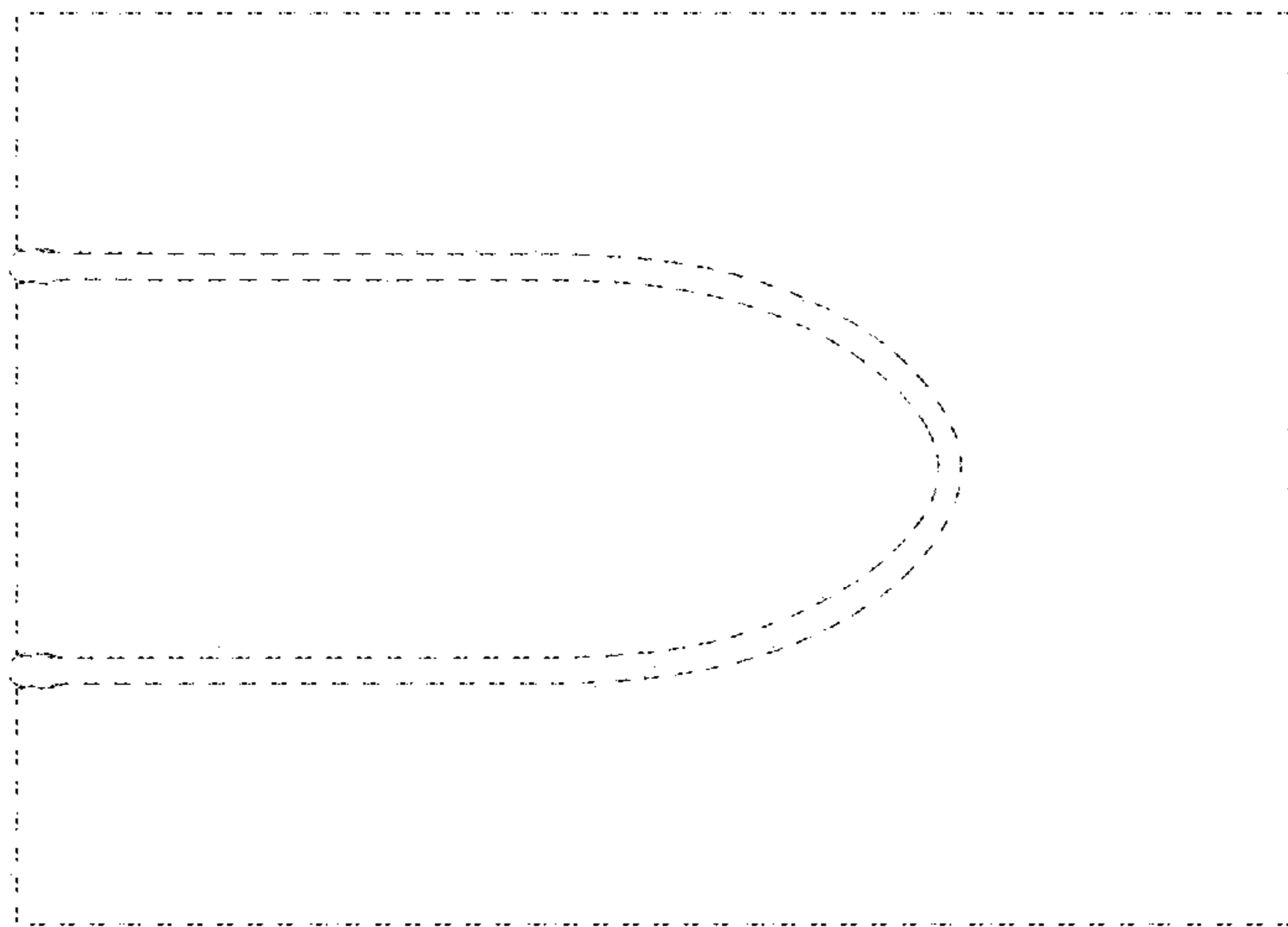

FIG. 11

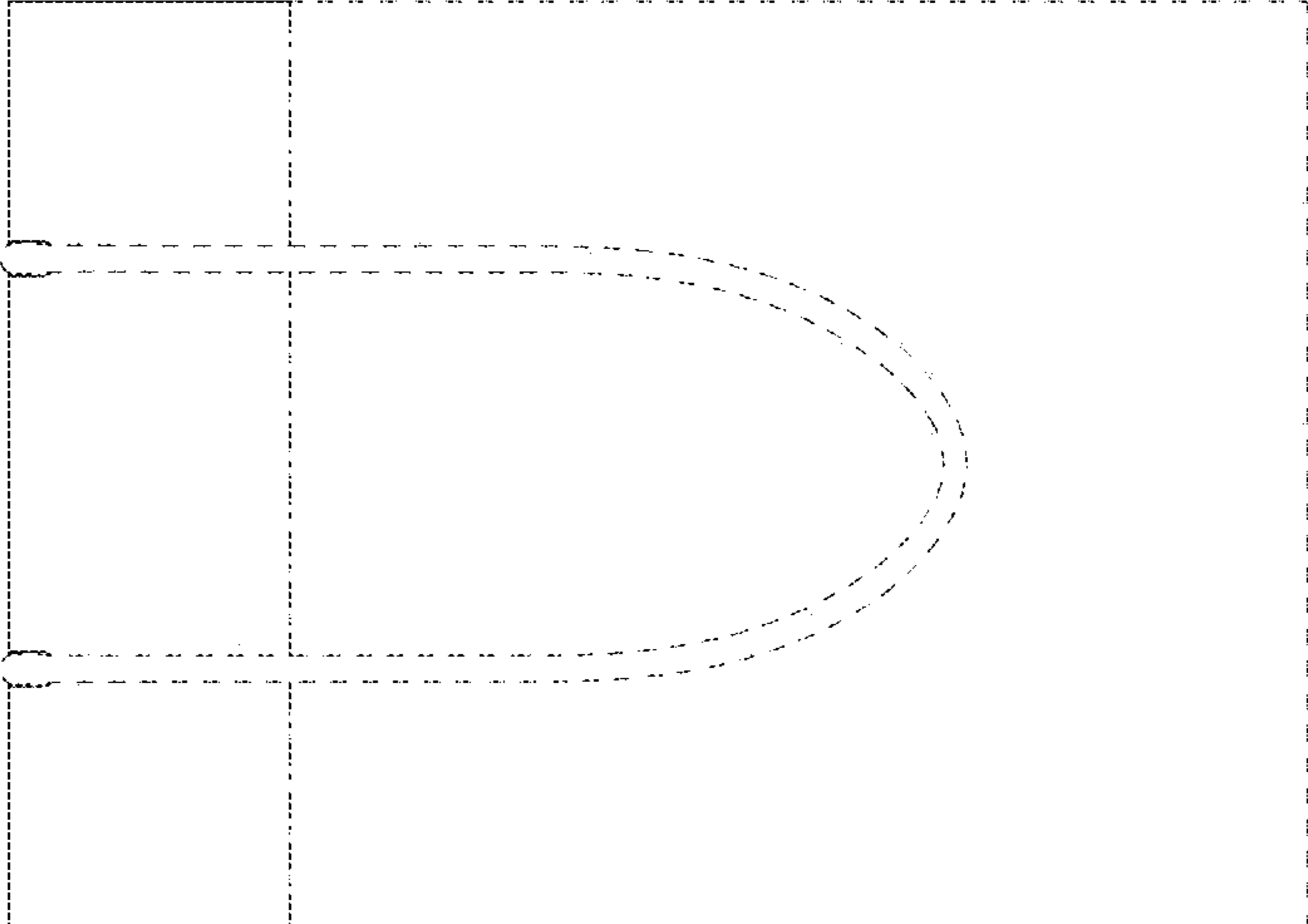

FIG. 12

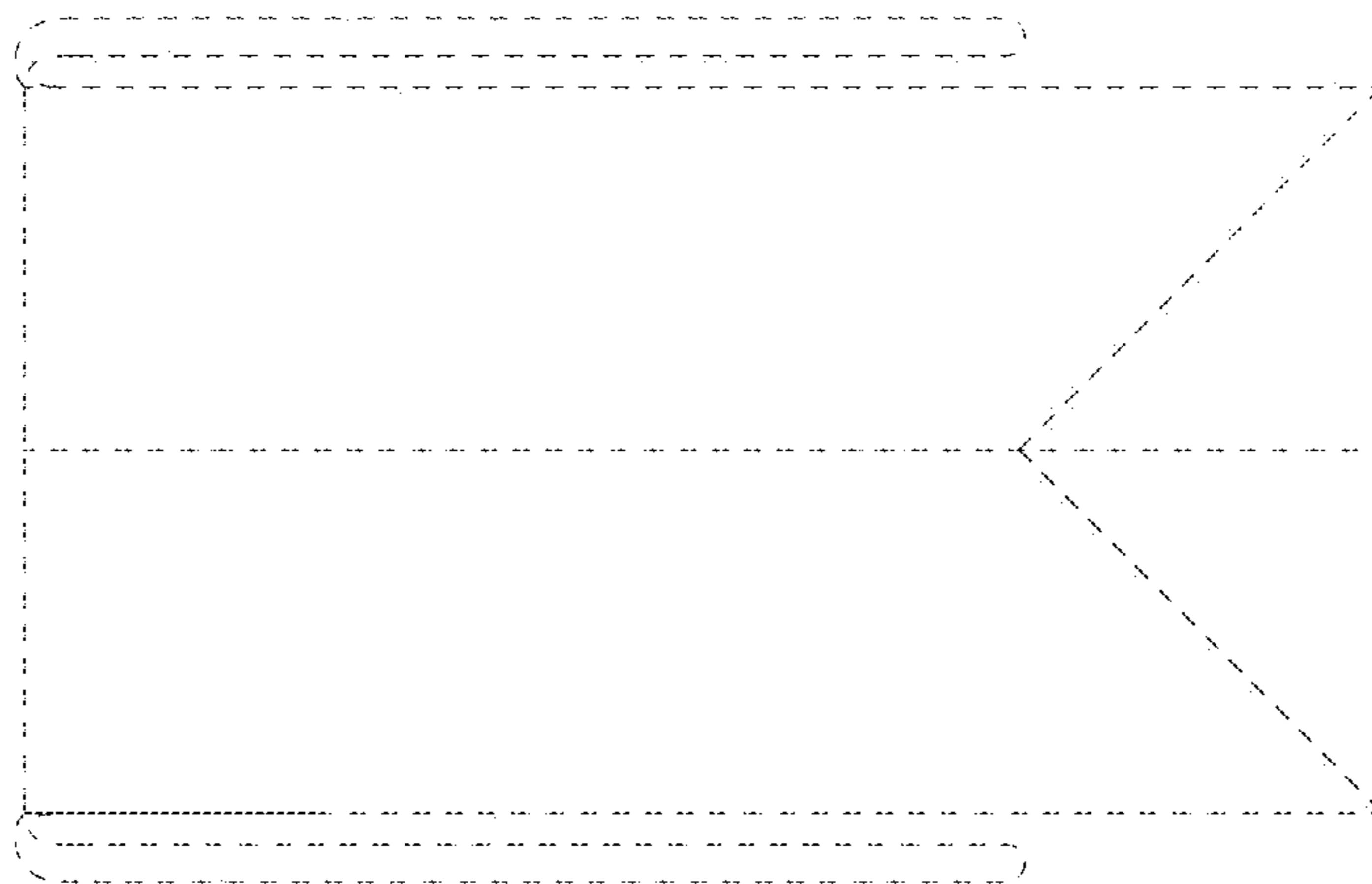

FIG. 13

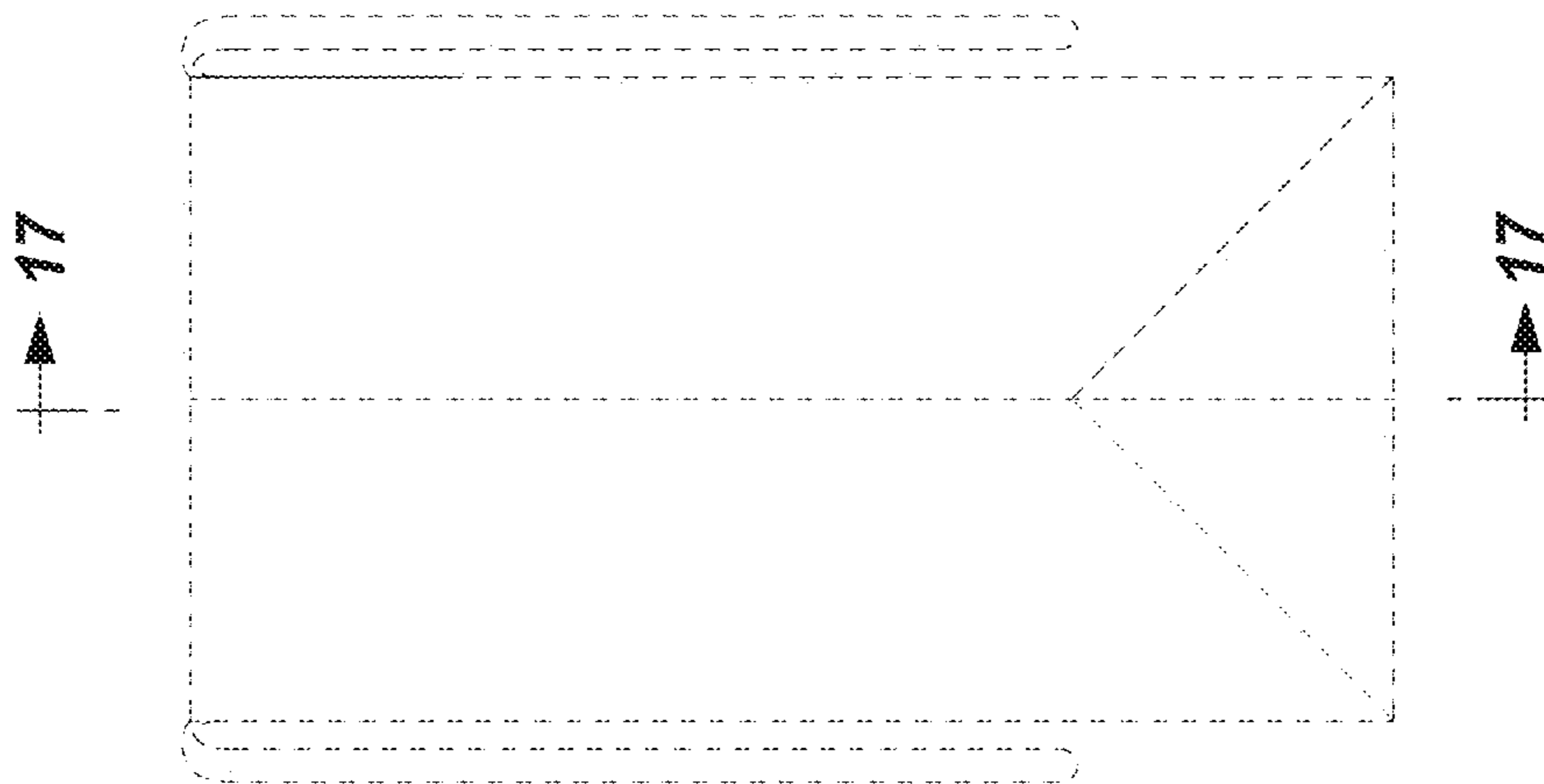

FIG. 14

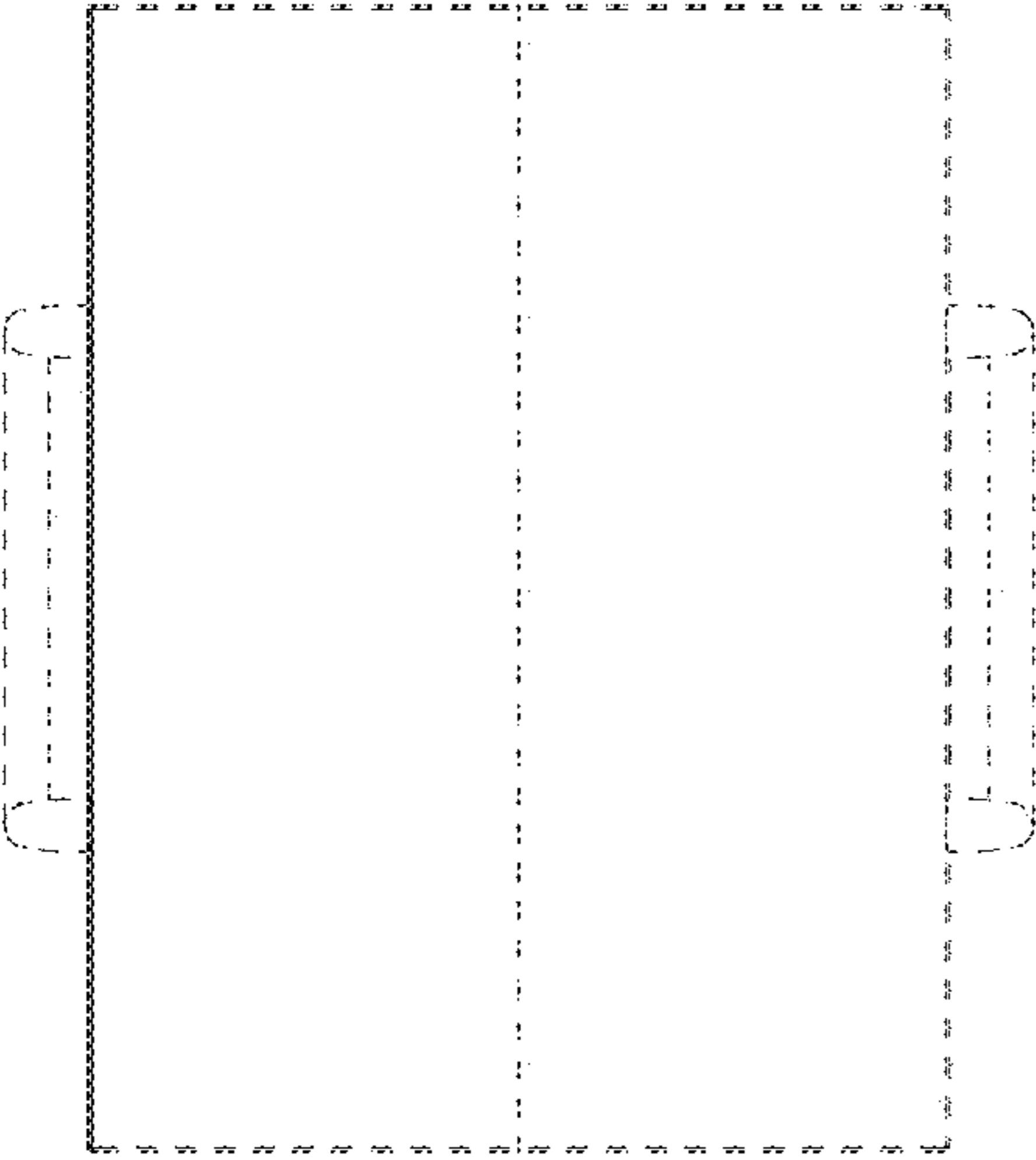

FIG. 15

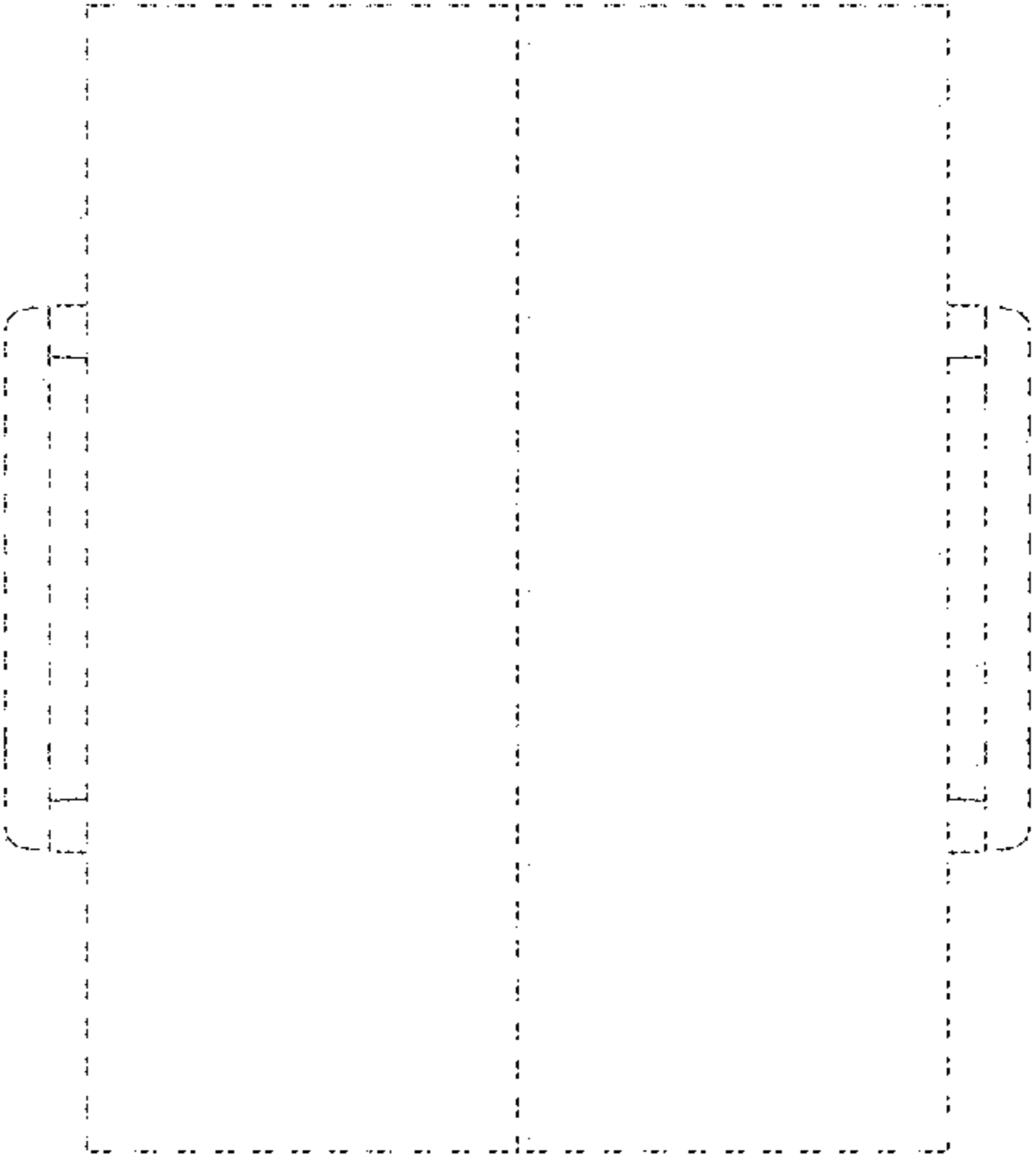

FIG. 16



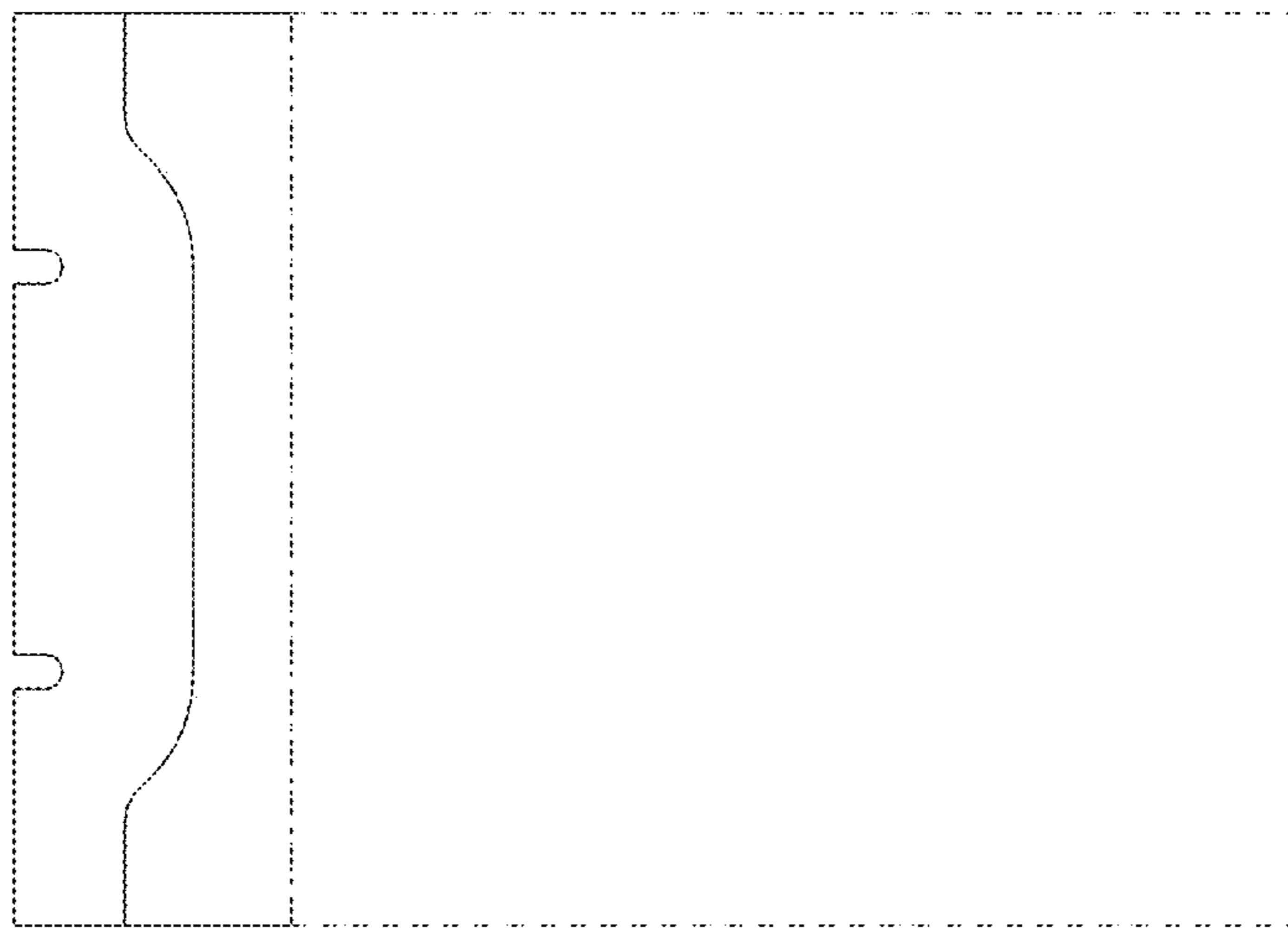
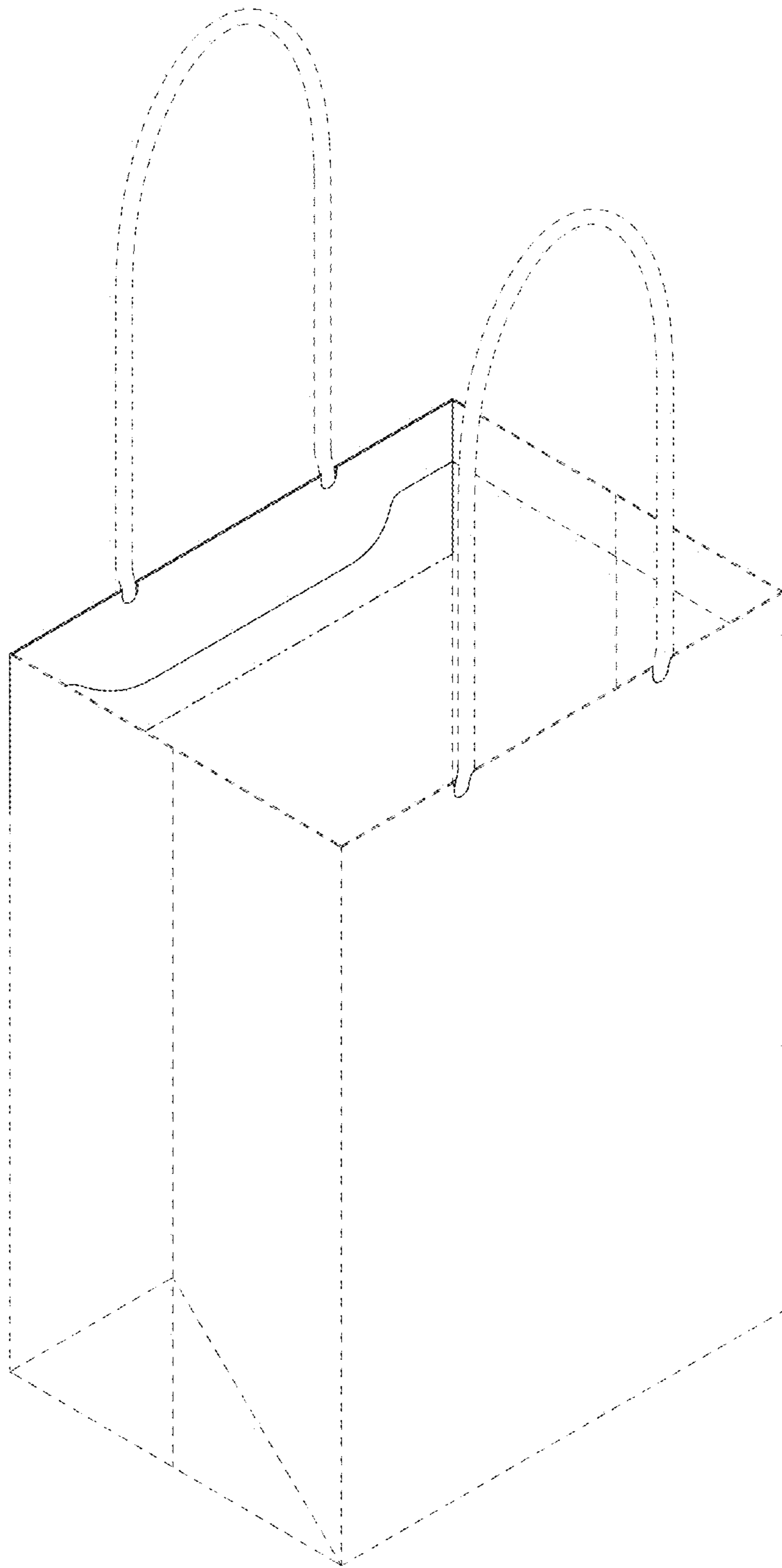

FIG. 17



**FIG. 18**