



US00D887799S

(12) **United States Design Patent** (10) **Patent No.:** **US D887,799 S**
Federico Nora (45) **Date of Patent:** **** Jun. 23, 2020**

(54) **FLYWHEEL LOCK**

OTHER PUBLICATIONS

(71) Applicant: **Francisco Javier Federico Nora**, Estes Park, CO (US)

New Flywheel Lock Trick. <https://www.bmw2002faq.com/forums/topic/159632-new-flywheel-lock-trick/>.
<https://www.thesamba.com/vw/forum/viewtopic.php?p=6777074#6777074>.

(72) Inventor: **Francisco Javier Federico Nora**, Estes Park, CO (US)

Expert EXP Quality Flywheel Holding Tool. http://www.toolsinstock.com/EXPERT_EXP_QUALITY_FLYWHEEL_HOLDING_TOOL-product-12533.html.

(**) Term: **15 Years**

Flywheel Locking Tool. <http://www.freedomracing.com/flywheel-locking-tool-119280.html>.

(21) Appl. No.: **29/671,301**

<https://rennlist.com/forums/928-forum/267731-flywheel-lock-2.html>.

(22) Filed: **Nov. 26, 2018**

* cited by examiner

(51) **LOC (12) Cl.** **08-05**

Primary Examiner — Philip S Hyder

(52) **U.S. Cl.**

USPC **D8/14**

(58) **Field of Classification Search**

(57) **CLAIM**

USPC D8/14, 45, 47, 90, 330, 402, 349, 354;
D21/497, 503, 694, 682; D15/5
CPC F16F 15/30; F16F 2230/0041; B25B
27/0035; B25B 13/48

The ornamental design for a flywheel lock, as shown and described.

See application file for complete search history.

DESCRIPTION

(56) **References Cited**

FIG. 1 is a perspective view of a flywheel lock showing my new design;
FIG. 2 is a front view thereof, the back view being a mirror image of FIG. 2;
FIG. 3 is a side view thereof;
FIG. 4 is a top view thereof;
FIG. 5 is a bottom view thereof; and,
FIG. 6 is a front view thereof in a condition of use thereof. In FIG. 6, the broken lines showing of environmental structure for purposes of illustrating the flywheel lock in a condition of use. The broken lines and the structure they depict form no part of the claimed design.

U.S. PATENT DOCUMENTS

2,612,067 A * 9/1952 Brugmann B25B 27/0035
81/176.3
4,930,371 A * 6/1990 Schneider F02B 75/06
123/198 R
D561,545 S * 2/2008 Jahn D8/21
D658,436 S * 5/2012 Rae D7/394
8,869,650 B1 * 10/2014 Harris F16F 15/30
188/18 R
D777,555 S * 1/2017 Owens D8/330
2011/0185642 A1 * 8/2011 DeHart, Sr. E04D 13/076
52/12

1 Claim, 3 Drawing Sheets

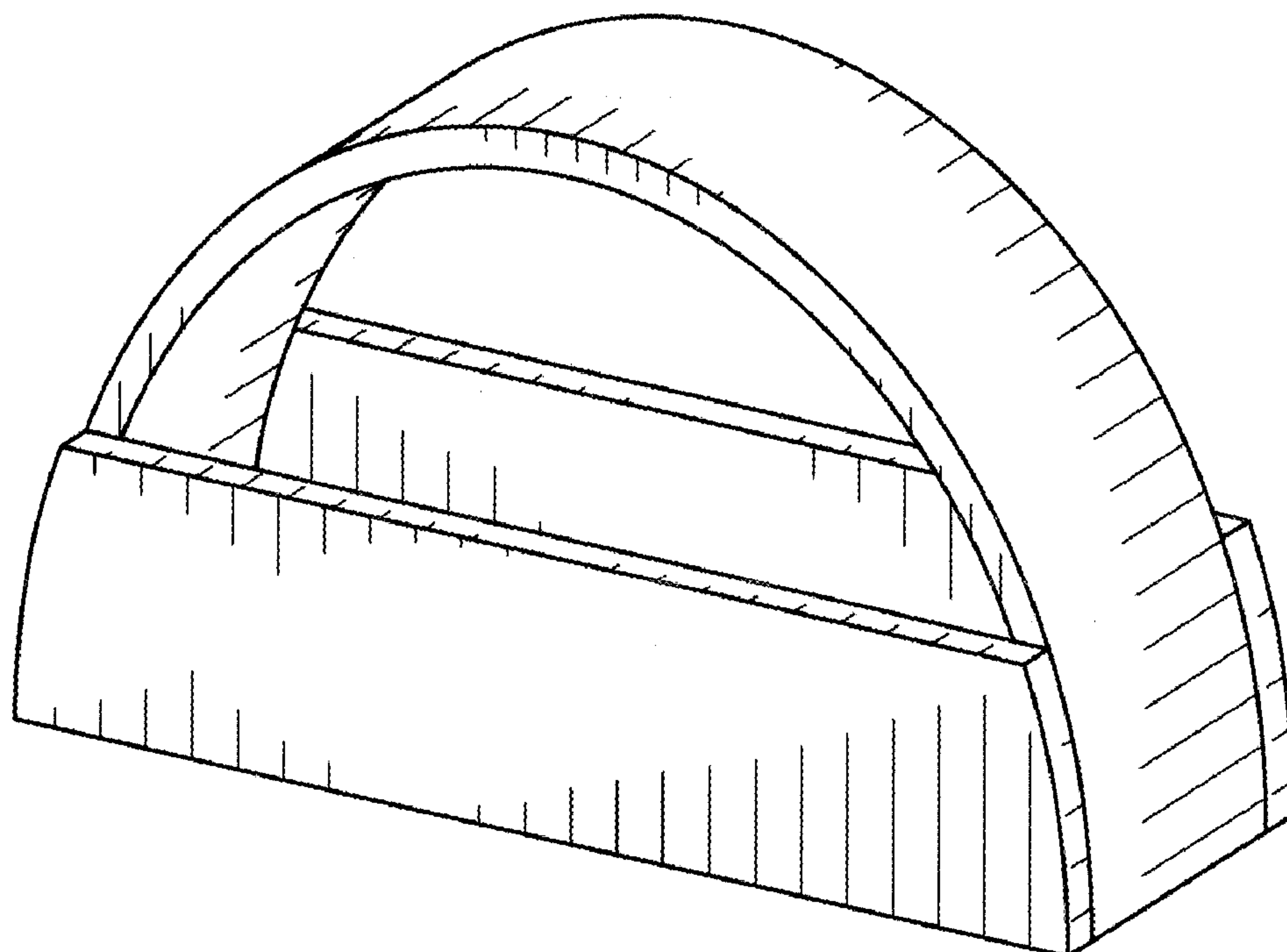

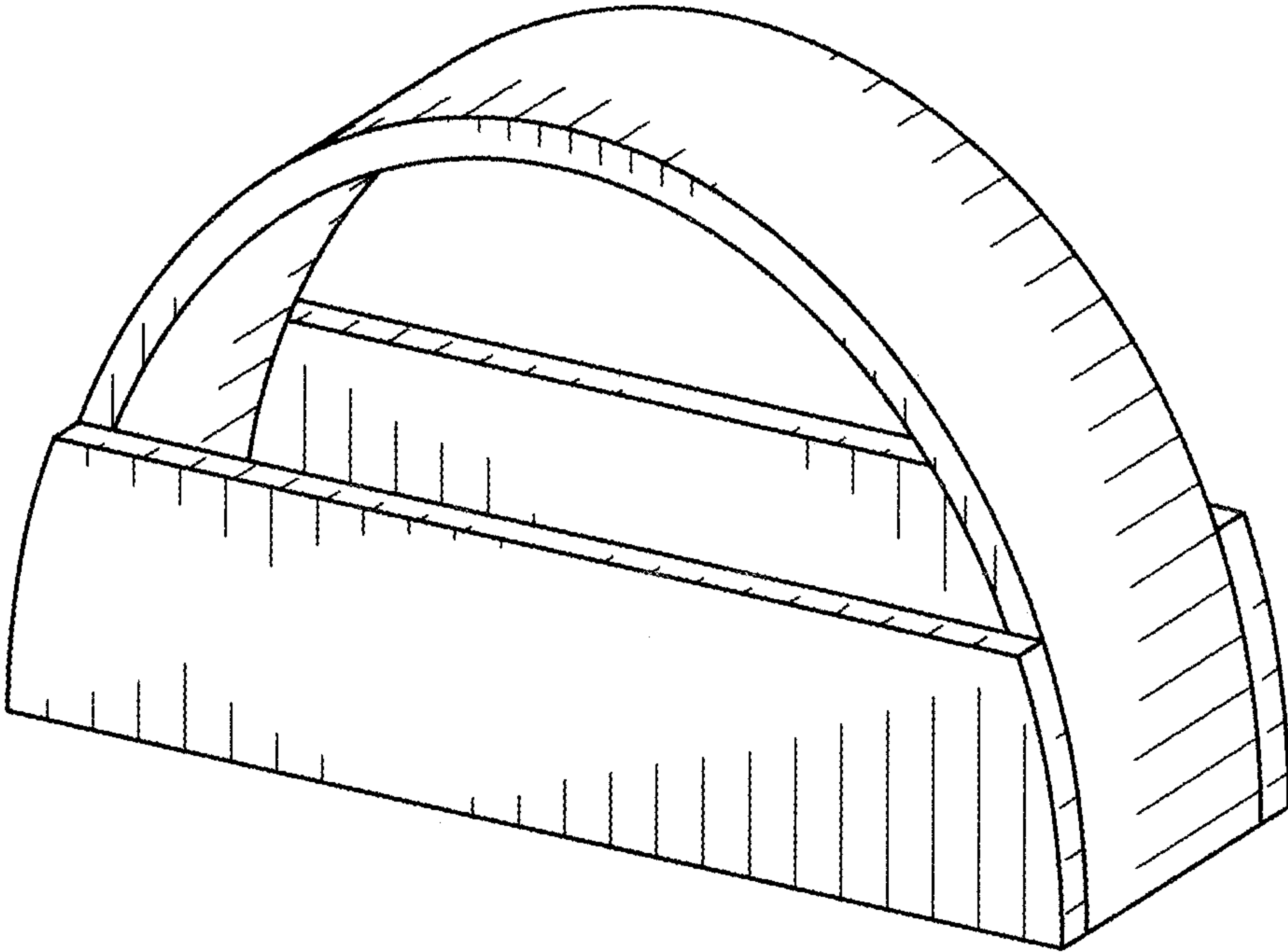

FIG. 1

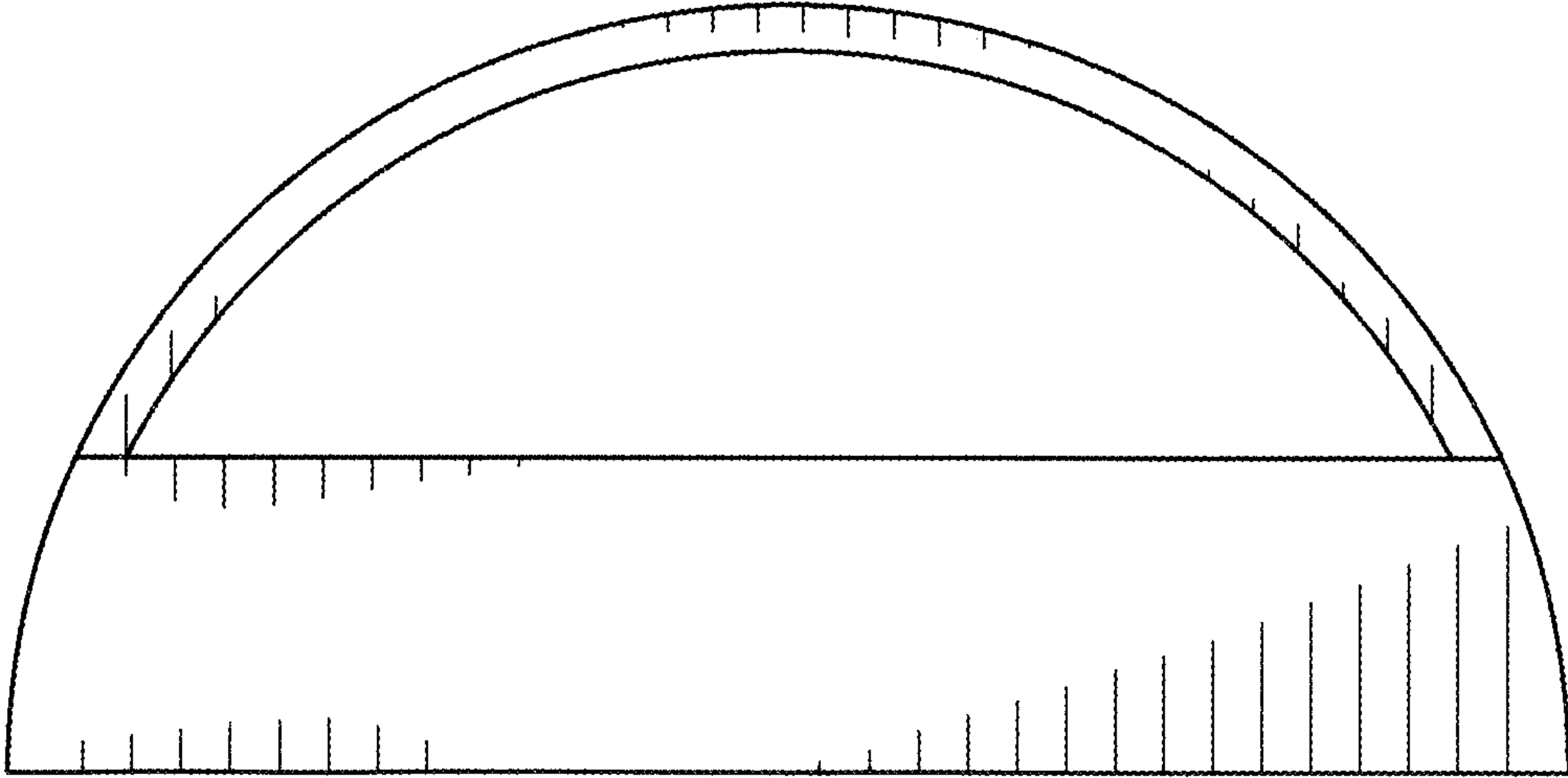

FIG. 2

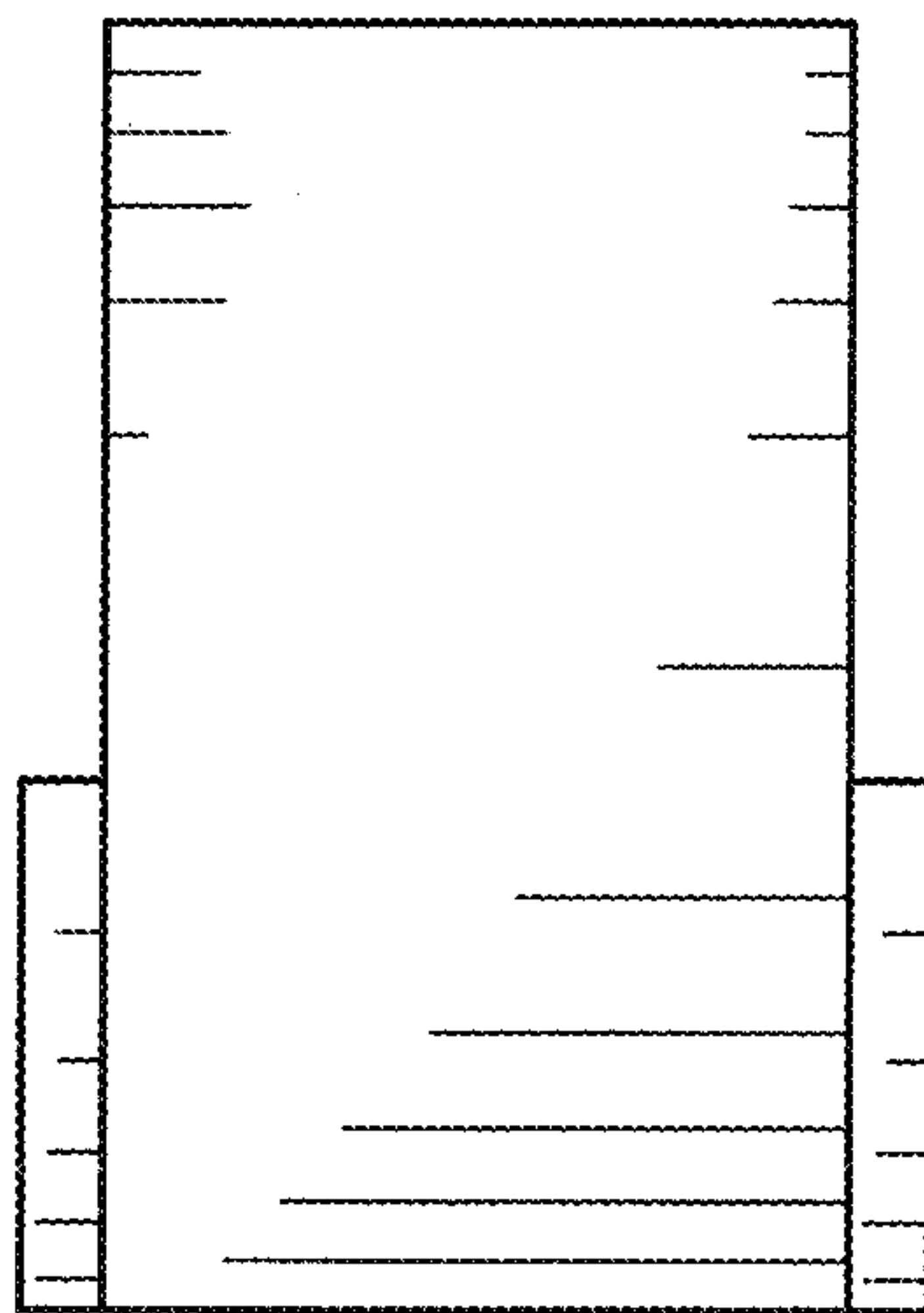

FIG. 3

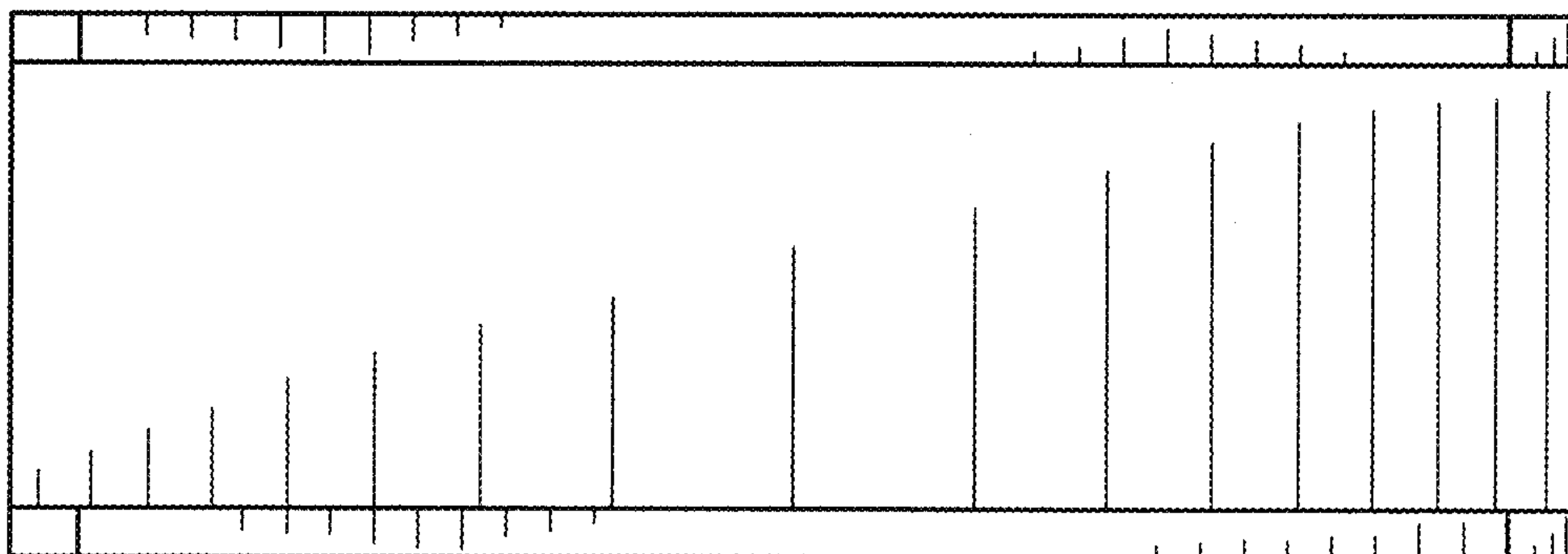

FIG. 4

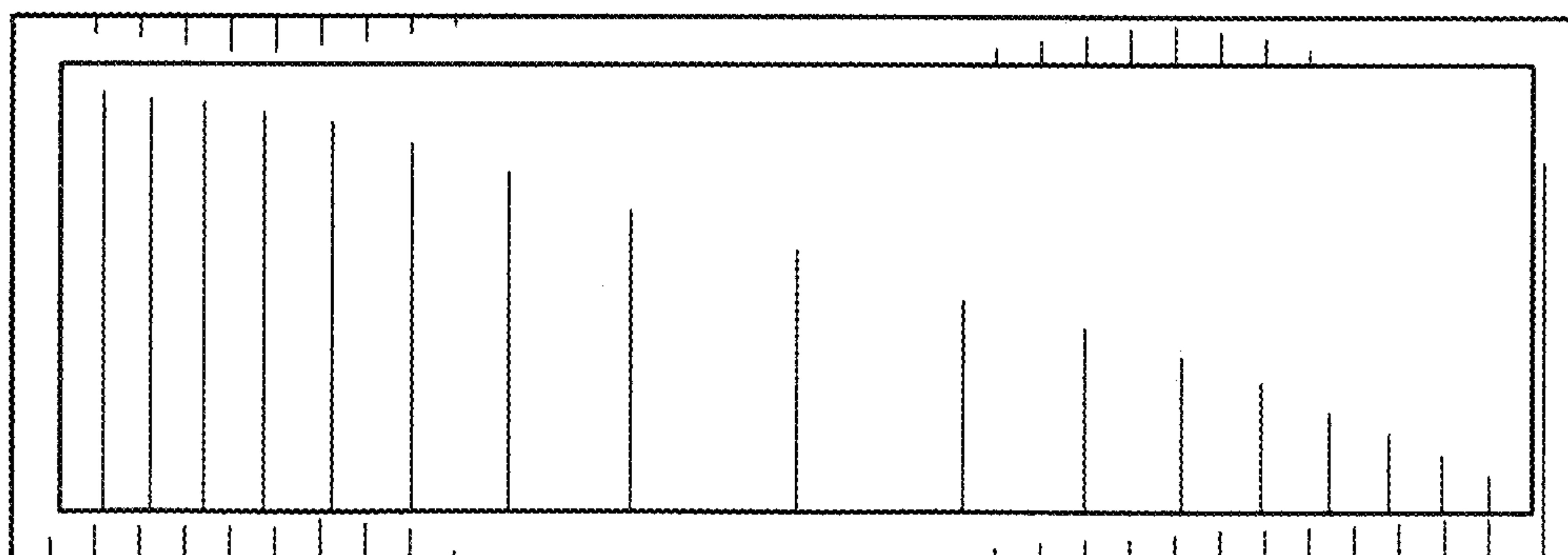

FIG. 5

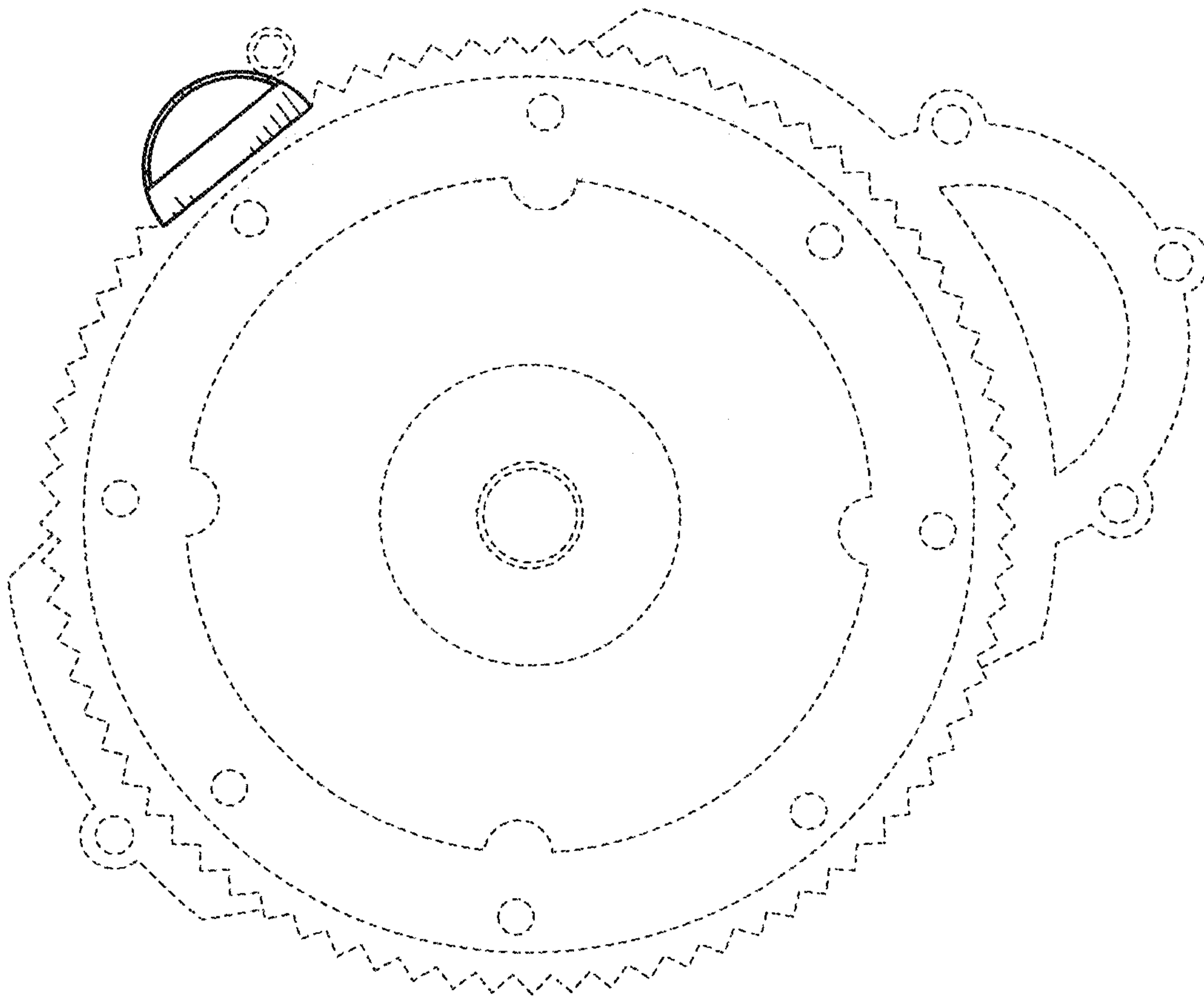

FIG. 6