



US00D887747S

(12) **United States Design Patent**
Chiang

(10) **Patent No.:** **US D887,747 S**

(45) **Date of Patent:** **** Jun. 23, 2020**

(54) **ADJUSTABLE WALL MOUNTED SHELF**

(71) Applicant: **MyGift Enterprise, LLC**, Woodinville, WA (US)

(72) Inventor: **Cliff Chiang**, Woodinville, WA (US)

(**) Term: **15 Years**

(21) Appl. No.: **29/669,634**

(22) Filed: **Nov. 9, 2018**

(51) **LOC (12) Cl.** **06-04**

(52) **U.S. Cl.**
USPC **D6/574**

(58) **Field of Classification Search**
USPC D6/574, 553, 555, 567, 569, 479, 675.1, D6/678.1; 108/33, 40, 42, 115, 134; 206/509, 312.1; 211/13.1, 87.01, 85.17, 211/90.02, 126.5, 134; 312/107, 198
CPC A47B 95/008; A47B 96/06; A47B 95/00
See application file for complete search history.

(56) **References Cited**

U.S. PATENT DOCUMENTS

D406,476 S * 3/1999 Boije D6/574
D491,751 S * 6/2004 Harwanko D6/675.1

D491,752 S * 6/2004 Harwanko D6/678.1
D547,585 S * 7/2007 Netto D6/574
D622,527 S * 8/2010 Wang D6/570
D832,613 S * 11/2018 Parikh D6/574

* cited by examiner

Primary Examiner — Mark Booker

(74) *Attorney, Agent, or Firm* — Dean Craine; Marisa Whitaker

(57) **CLAIM**

The ornamental design for an adjustable wall mounted shelf, as shown and described.

DESCRIPTION

FIG. 1 is a front perspective view of an adjustable wall mounted shelf, showing my new design.
FIG. 2 is a front elevational view of the invention
FIG. 3 is a rear elevational view of the invention.
FIG. 4 is a top plan view of the invention.
FIG. 5 is a bottom plan view of the invention.
FIG. 6 is a left side elevational view of the invention; and,
FIG. 7 is a right side elevational view of the invention.

1 Claim, 7 Drawing Sheets

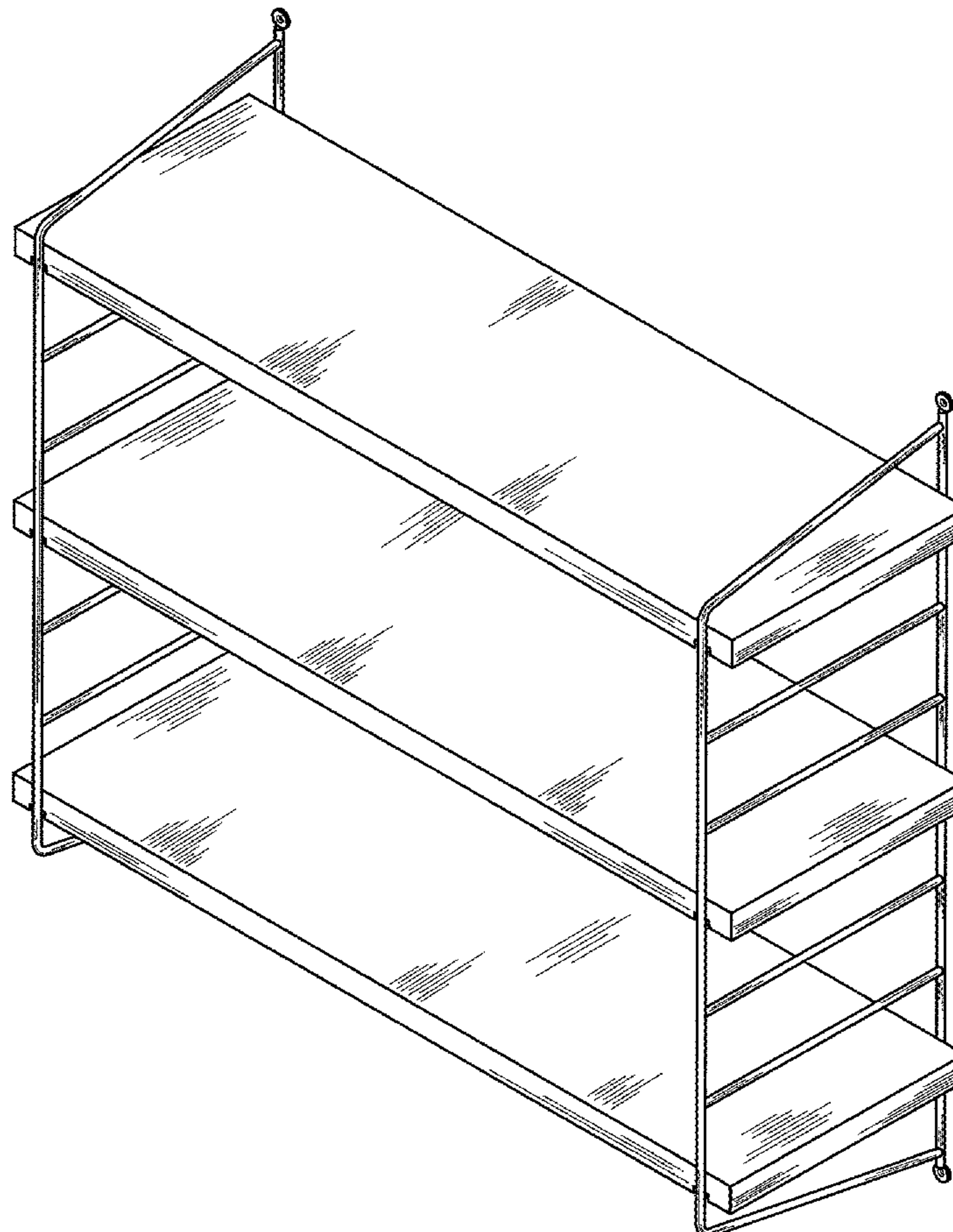

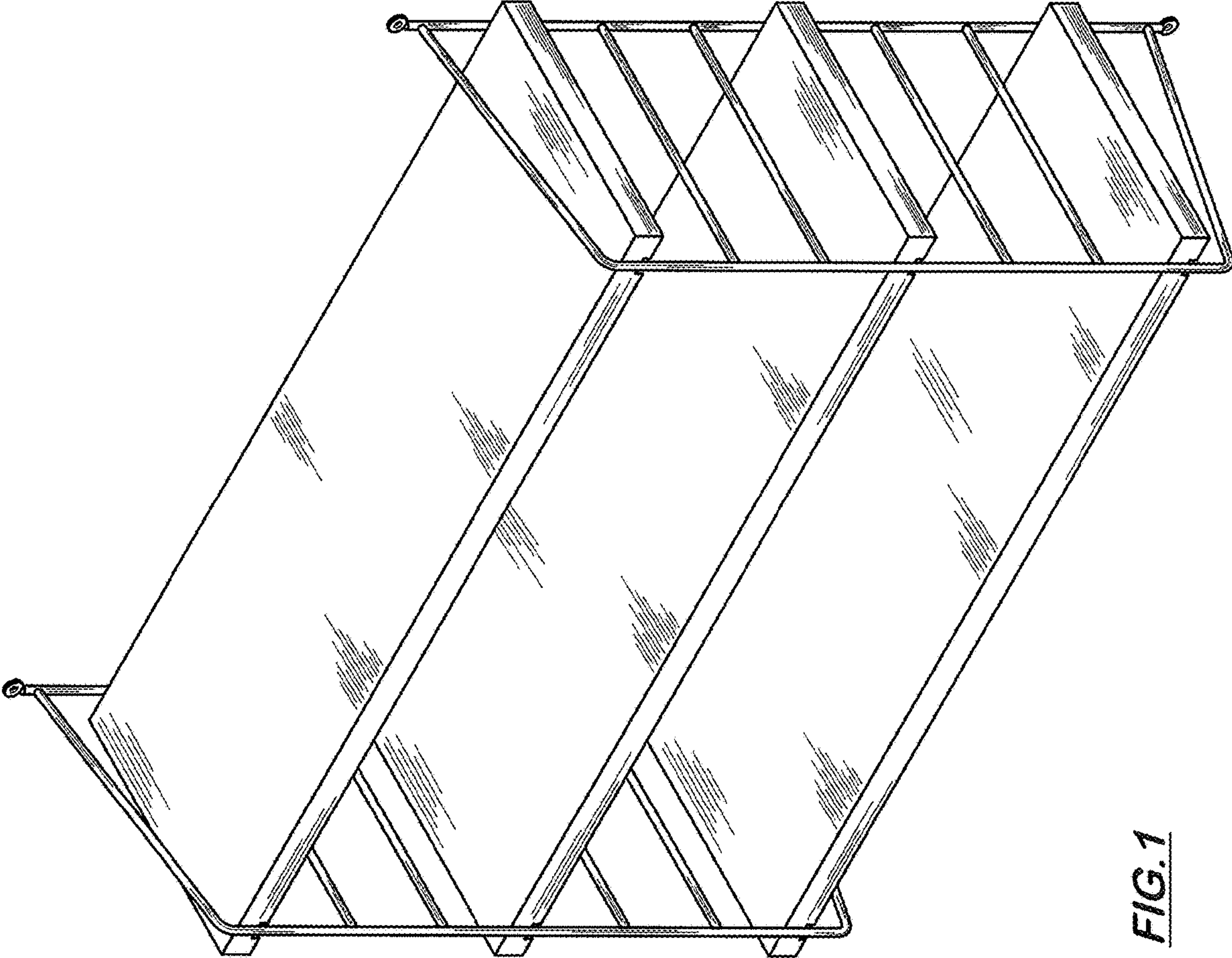

FIG. 1

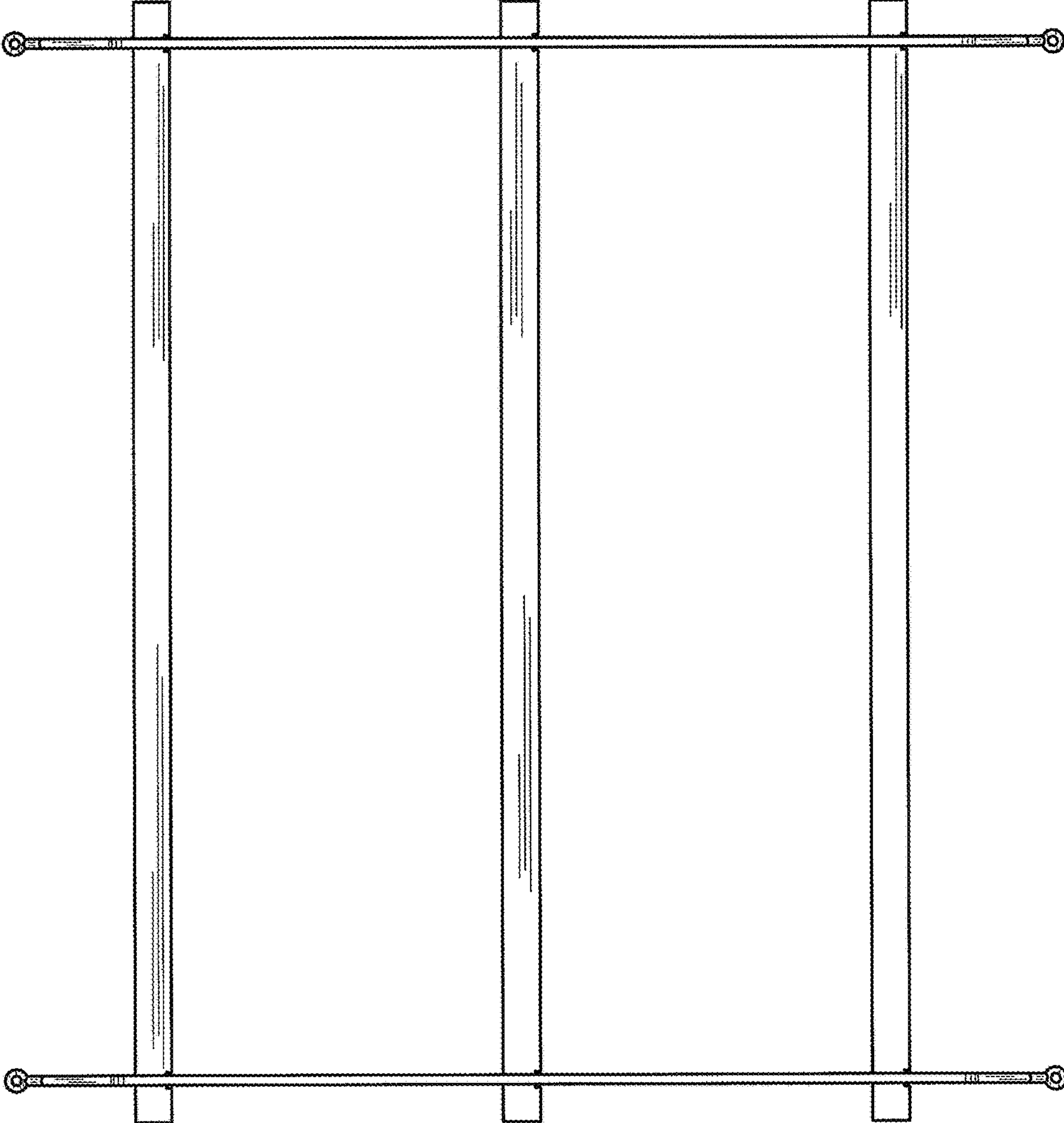

FIG. 2

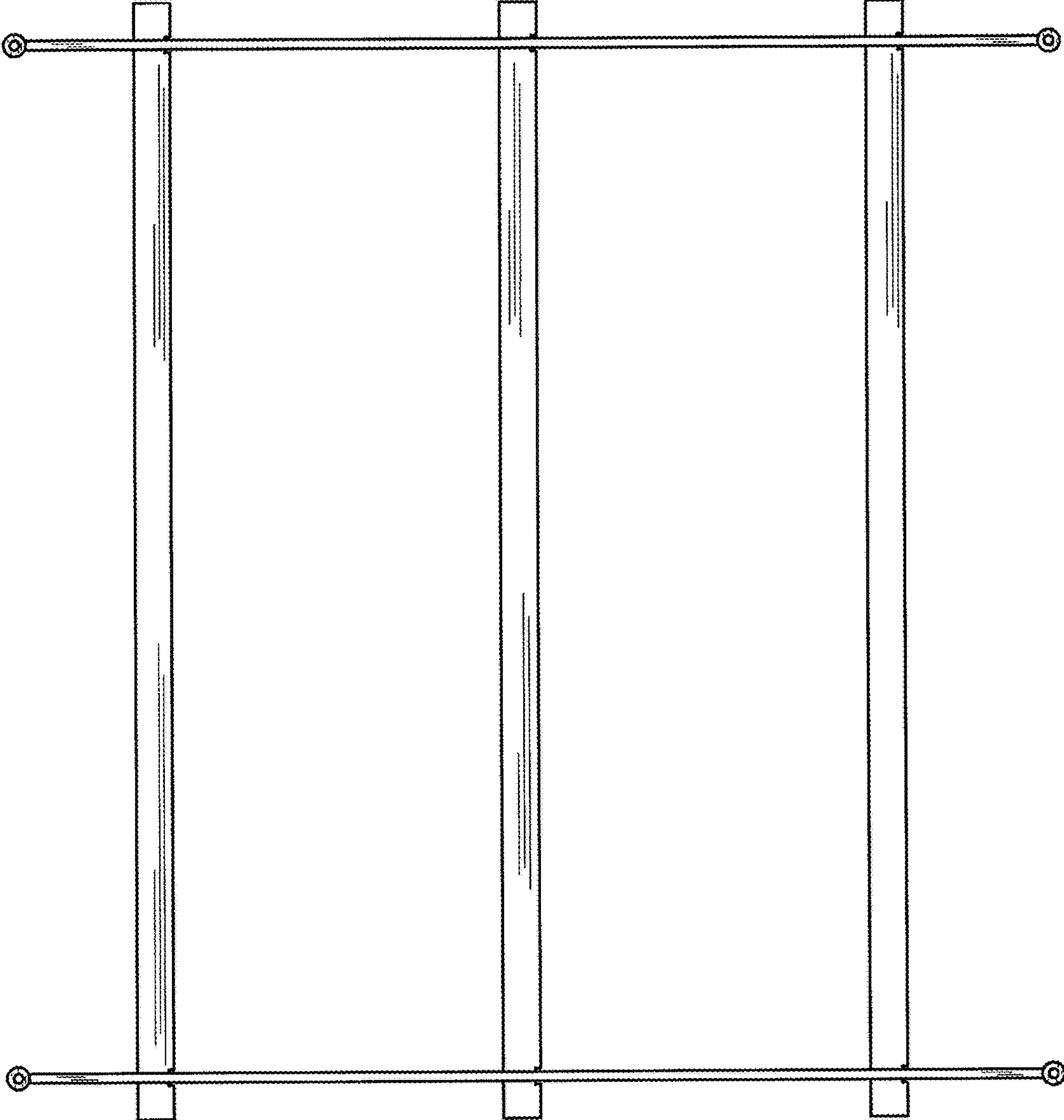

FIG. 3

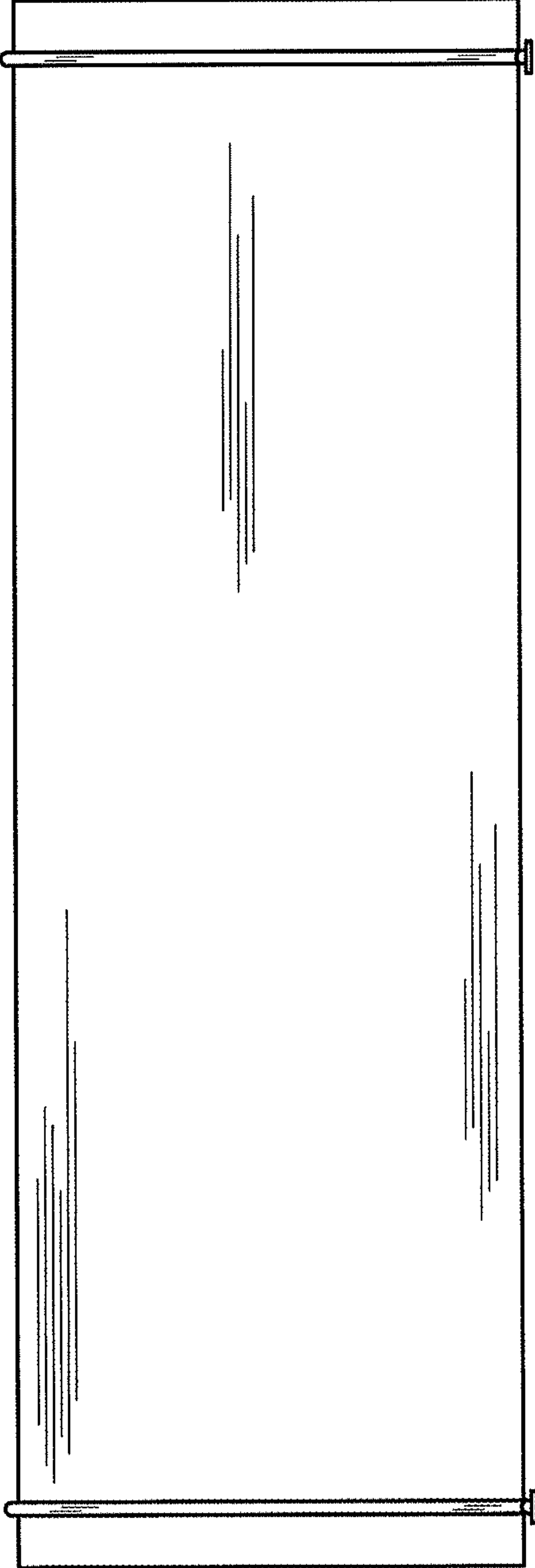

FIG. 4

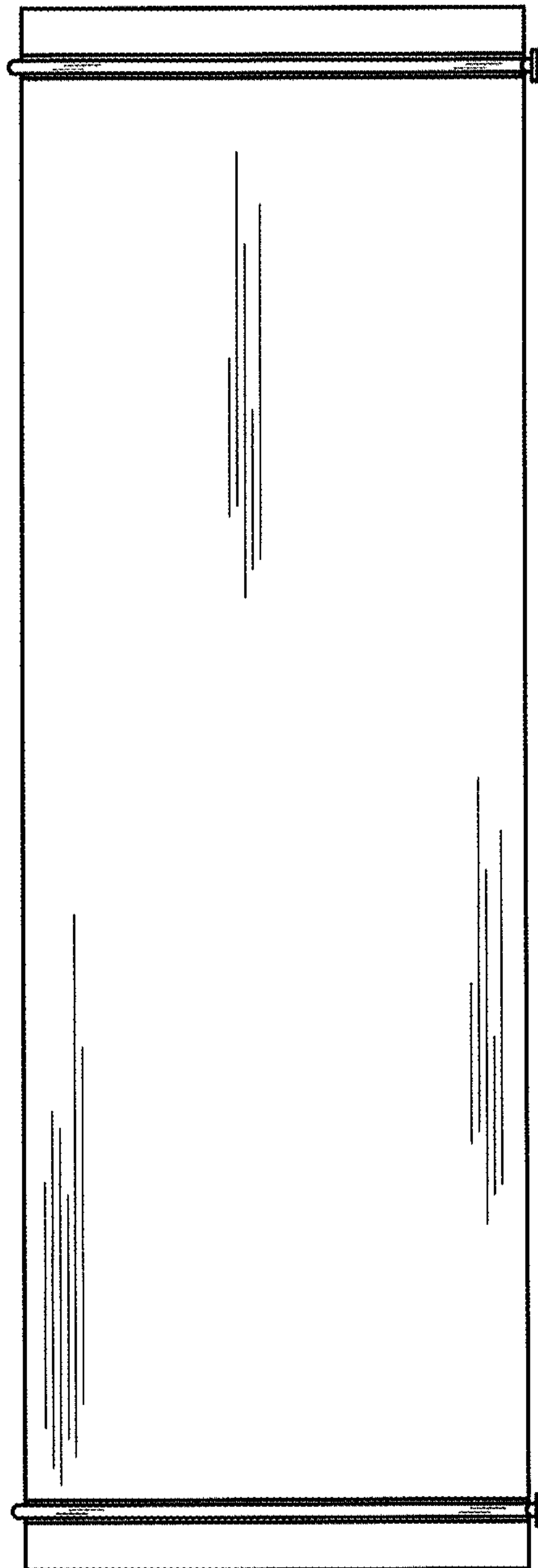

FIG. 5

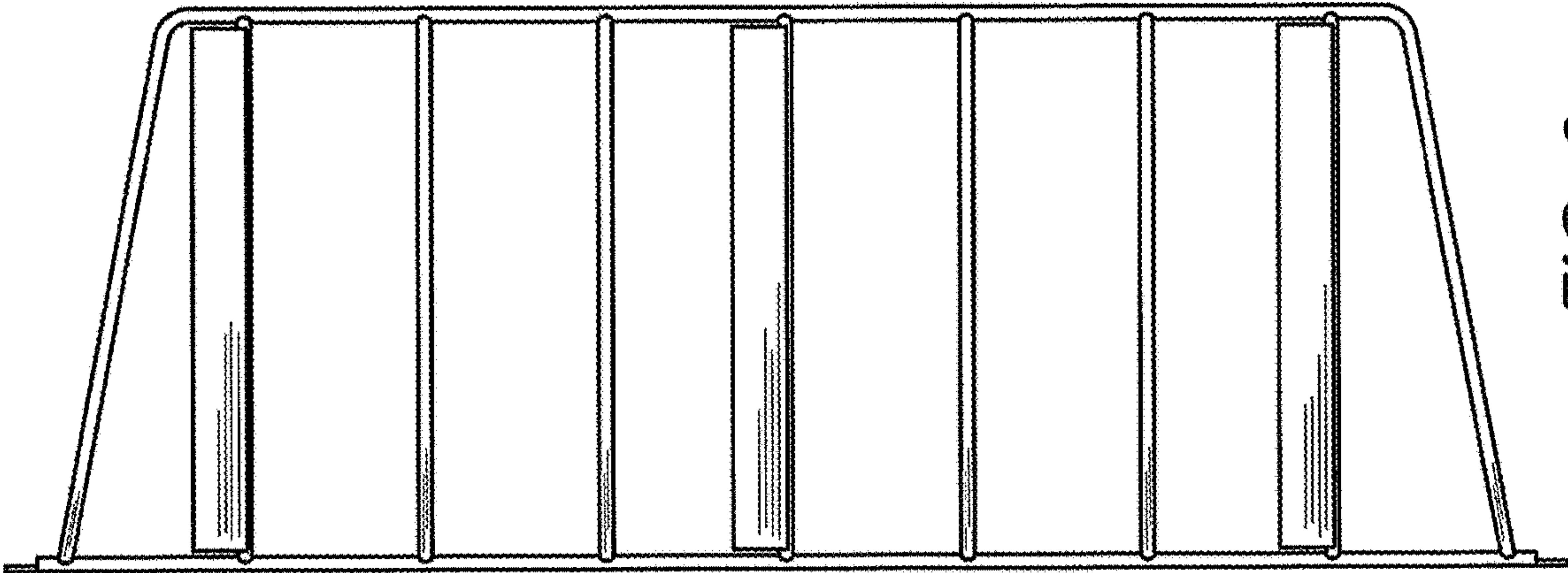

FIG. 6

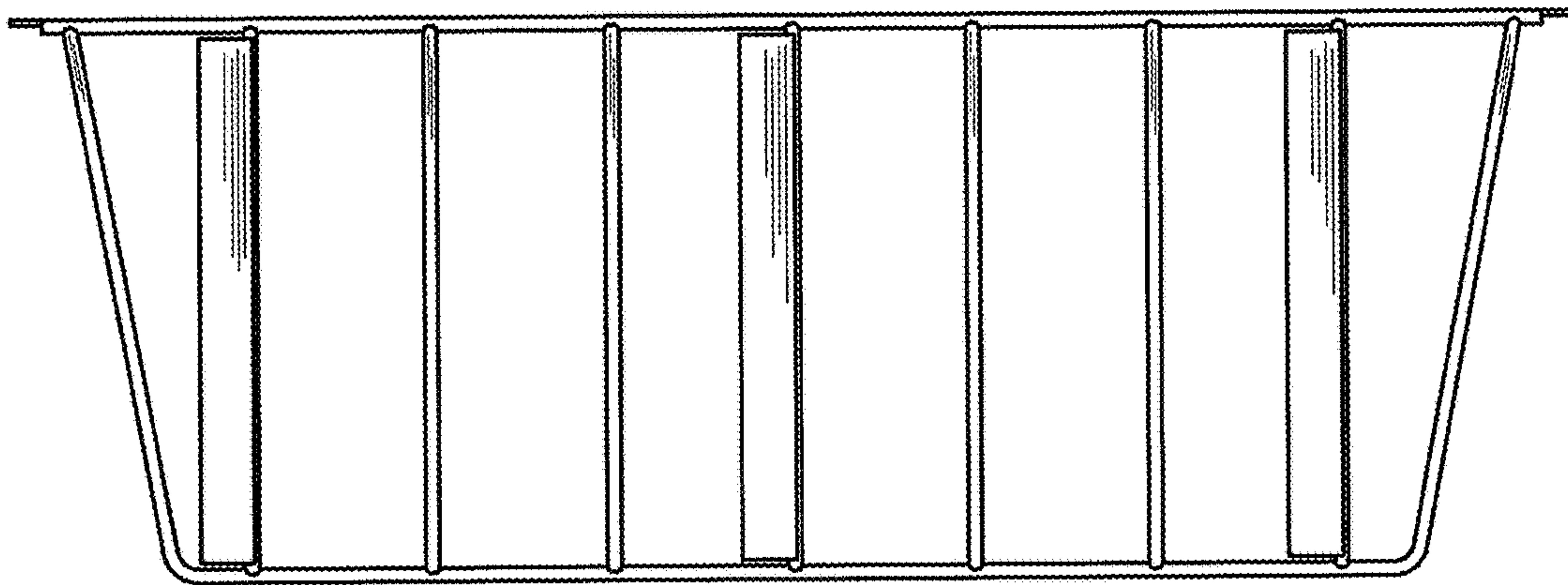

FIG. 7