



US00D887719S

(12) **United States Design Patent**
Kuang

(10) **Patent No.:** **US D887,719 S**
(45) **Date of Patent:** **** Jun. 23, 2020**

(54) **TOOTHBRUSH HEAD**

(71) Applicant: **Juanyun Kuang**, Shenzhen (CN)

(72) Inventor: **Juanyun Kuang**, Shenzhen (CN)

(**) Term: **15 Years**

(21) Appl. No.: **29/719,520**

(22) Filed: **Jan. 6, 2020**

(51) **LOC (12) Cl.** **04-02**

(52) **U.S. Cl.**
USPC **D4/101**

(58) **Field of Classification Search**
USPC D4/100, 101, 102, 104, 108, 110, 111,
D4/127, 129; D24/107, 146, 152, 158,
D24/176, 193, 194
CPC A61C 15/00; A61C 15/047; A61C 15/048;
A61C 17/16; A61C 17/18; A61C 17/32;
A61C 17/34; A61C 3/06; A46B 5/0008;
A46B 5/0095; A46B 2200/10; A46B
2200/108; A46B 2200/1026; A46B
2200/1066; A46B 2200/1073; A46B 9/04;
A61B 1/24

See application file for complete search history.

(56) **References Cited**

U.S. PATENT DOCUMENTS

D502,601 S * 3/2005 Lamason D4/101
D503,537 S * 4/2005 Lamason D4/101
D598,653 S * 8/2009 Crossman D4/101
D676,660 S * 2/2013 Crossman D4/101
D700,436 S 3/2014 Fritsch et al.
D831,358 S 10/2018 Altmann et al.

D863,771 S 10/2019 Zavalloni
D866,188 S * 11/2019 Wagner A61C 17/3418
D4/101
2008/0028548 A1* 2/2008 Hall A46B 7/06
15/22.2
2008/0295760 A1* 12/2008 Wielstra A43B 15/0002
116/204
2010/0037912 A1* 2/2010 Baughman A61C 15/047
132/323
2018/0185128 A1* 7/2018 Dai A61C 17/3436

* cited by examiner

Primary Examiner — Wan Laymon
Assistant Examiner — Clint A Samuel
(74) *Attorney, Agent, or Firm* — HYIP

(57) **CLAIM**

The ornamental design for a toothbrush head, as shown and described.

DESCRIPTION

FIG. 1 is a perspective view of a toothbrush head showing my new design;
FIG. 2 is a front view thereof;
FIG. 3 is a back view thereof;
FIG. 4 is a left side view thereof;
FIG. 5 is a right side view thereof;
FIG. 6 is a top view thereof; and,
FIG. 7 is a bottom view thereof.

The broken lines shown in the drawings depict portions of the toothbrush head in which the design is embodied that form no part of the claimed design.

1 Claim, 7 Drawing Sheets

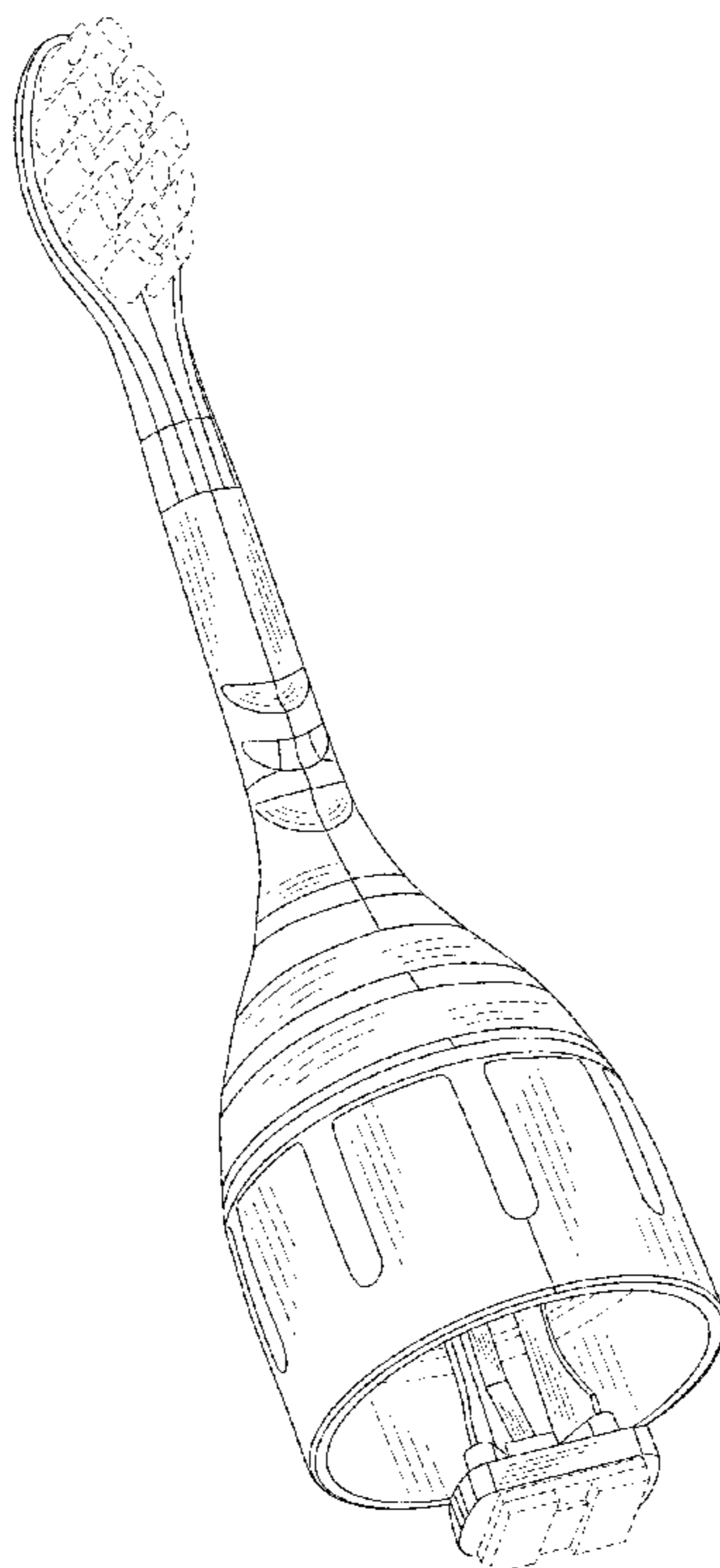

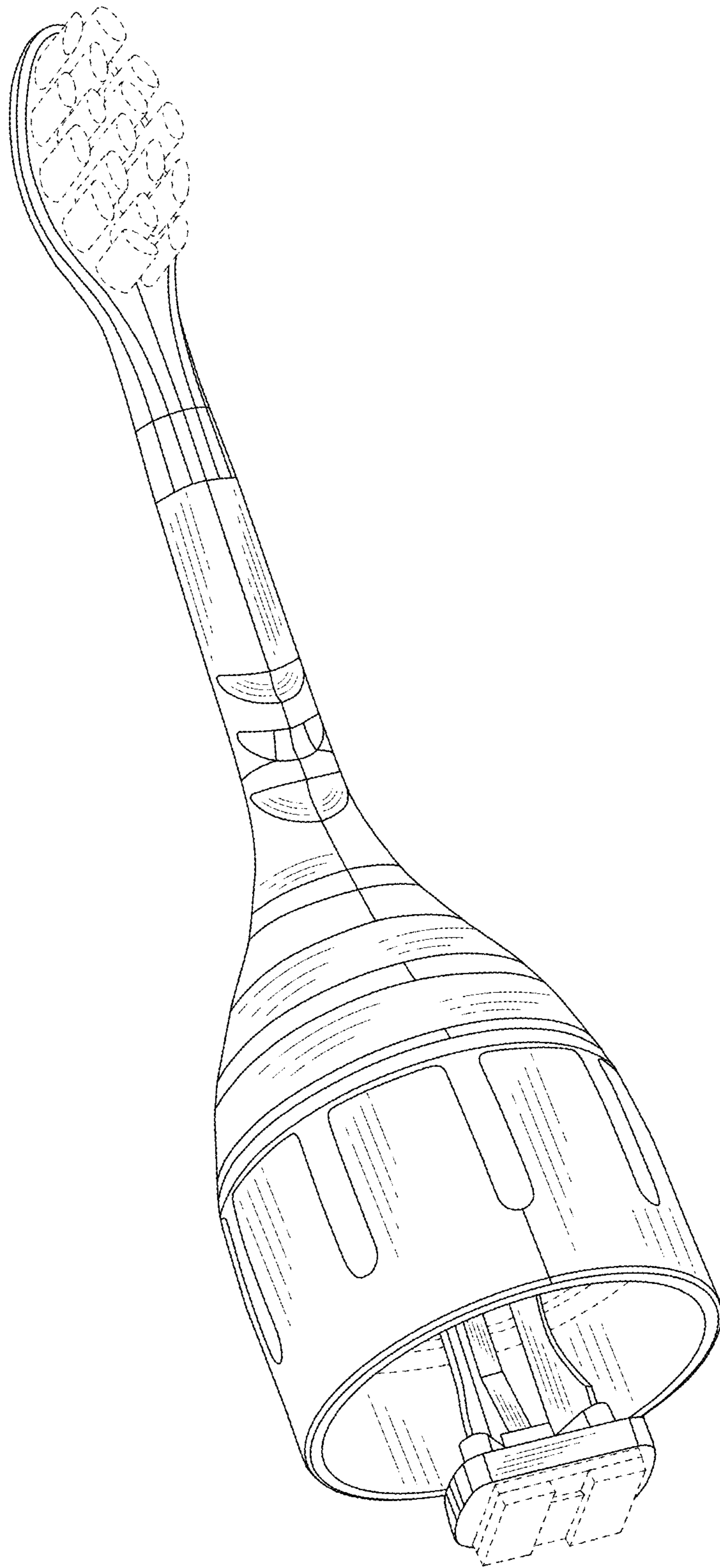

FIG. 1

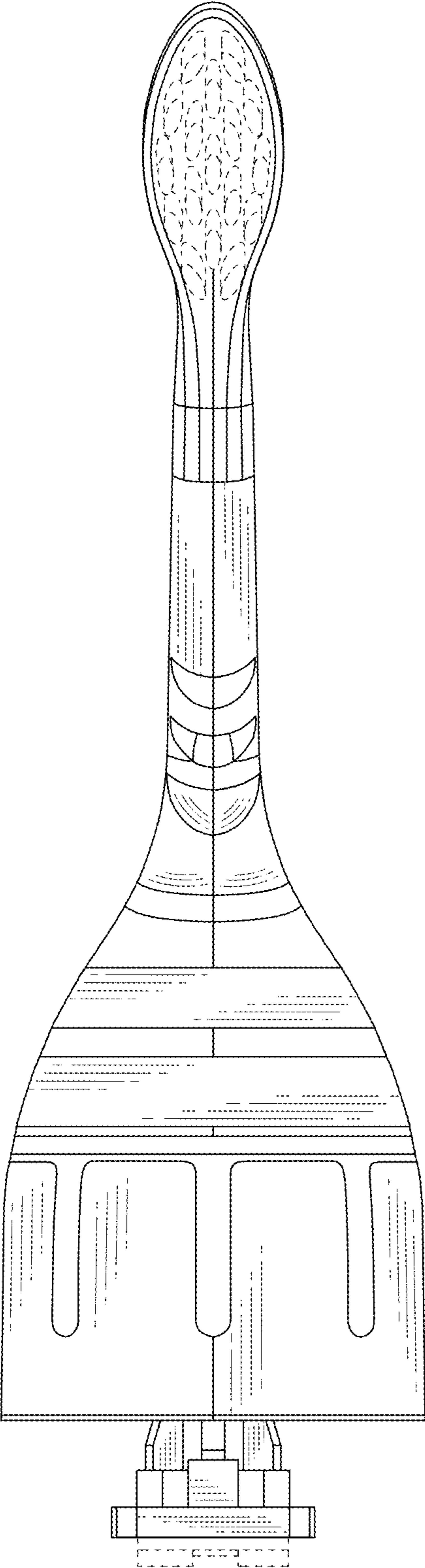

FIG. 2

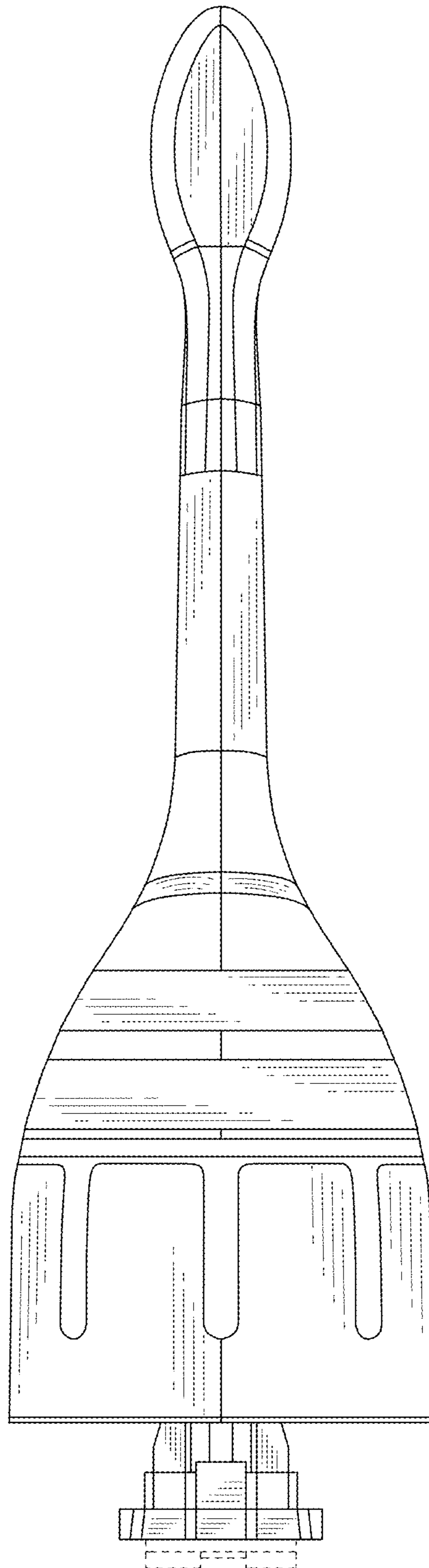

FIG. 3

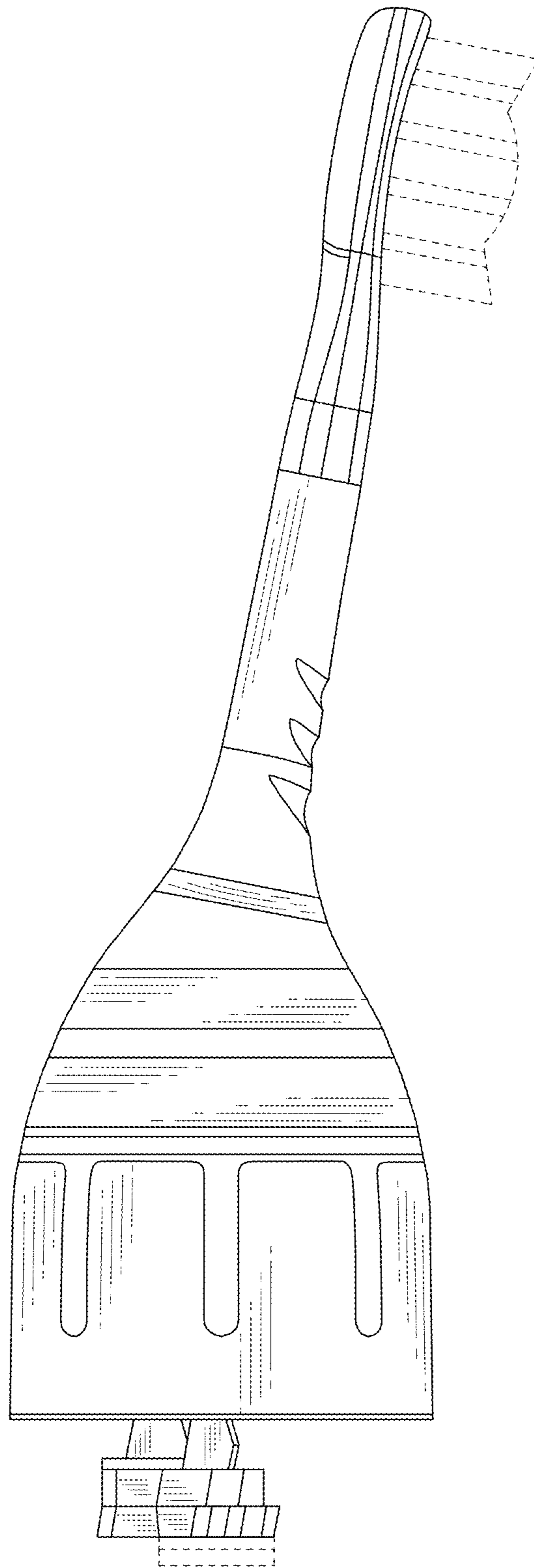

FIG. 4

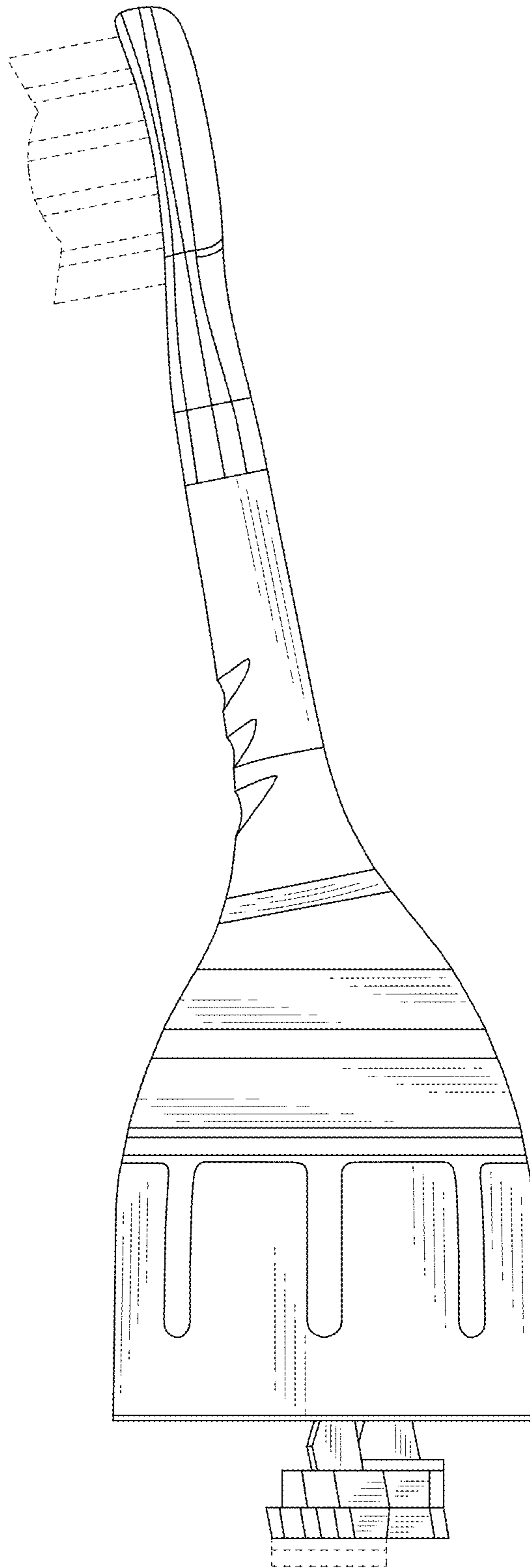

FIG. 5

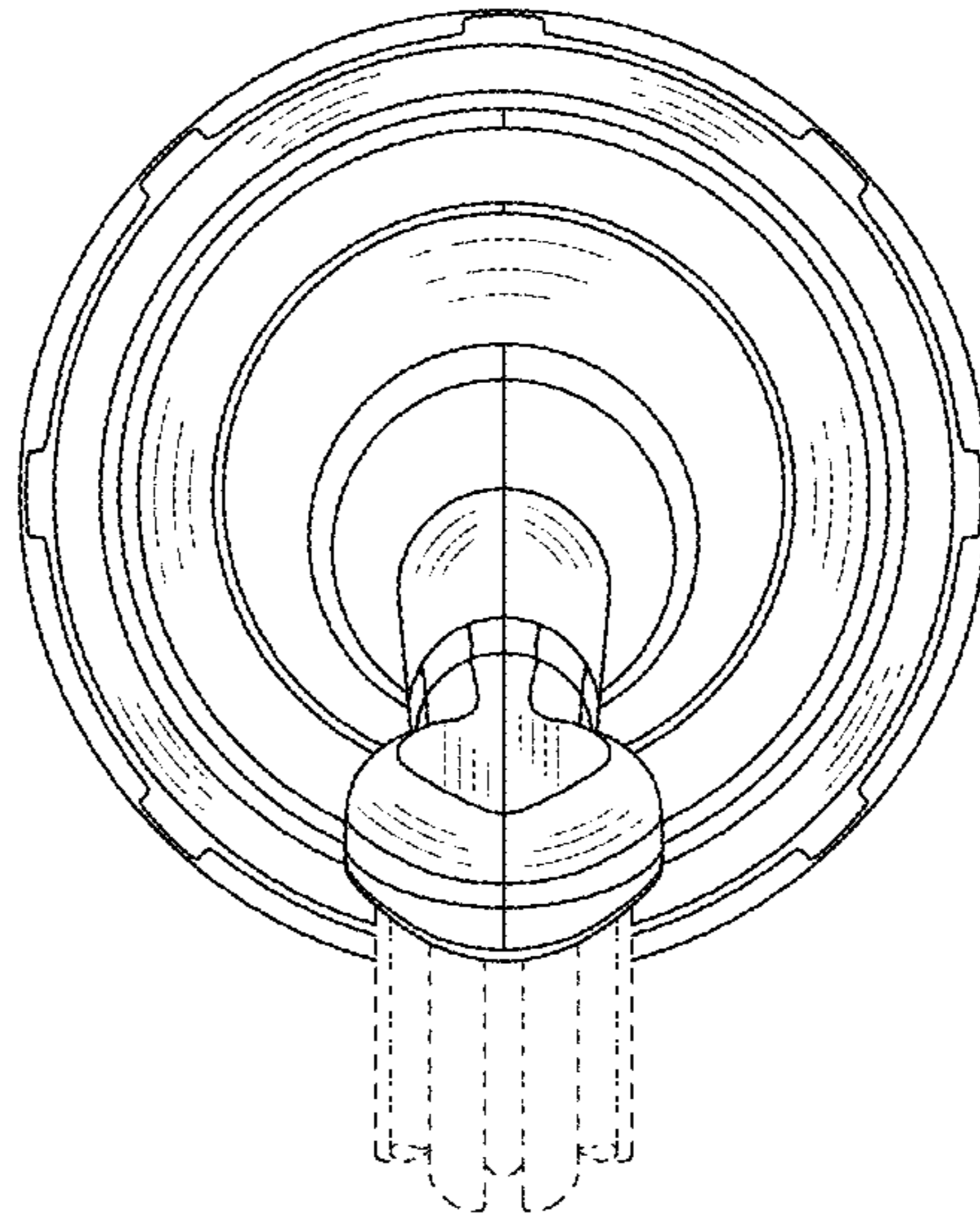

FIG. 6

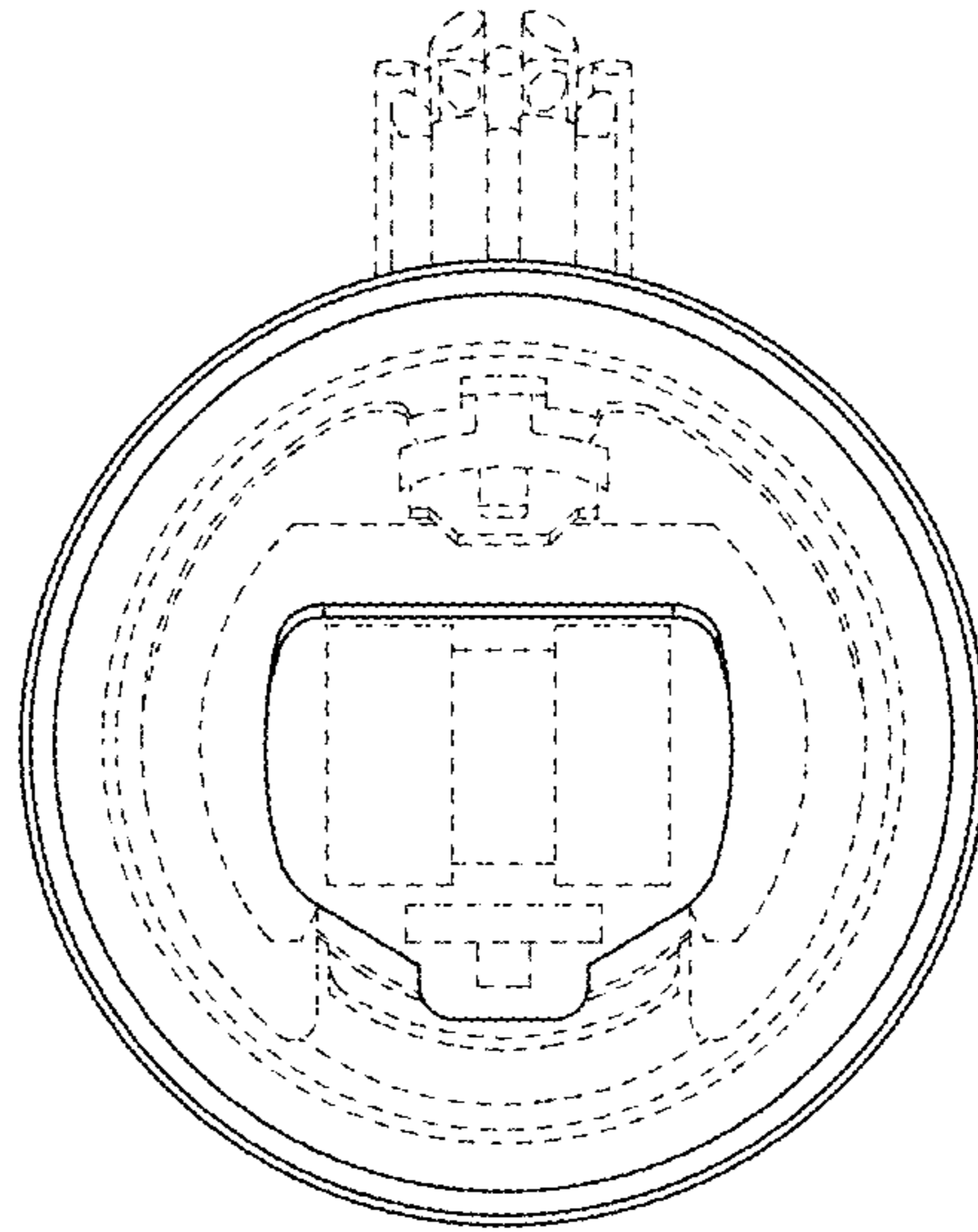

FIG. 7