



US00D887712S

(12) **United States Design Patent** (10) **Patent No.:** **US D887,712 S**
Stevens (45) **Date of Patent:** **** Jun. 23, 2020**

(54) **ANGLED ORGANIZER BIN**
(71) Applicant: **DV International Inc.**, St. Paul, MN (US)
(72) Inventor: **Hallie L. Stevens**, St. Paul, MN (US)
(73) Assignee: **DV International Inc.**, St. Paul, MN (US)

(**) Term: **15 Years**

(21) Appl. No.: **29/671,620**

(22) Filed: **Nov. 28, 2018**

(51) **LOC (12) Cl.** **03-01**

(52) **U.S. Cl.**
USPC **D3/313**

(58) **Field of Classification Search**
USPC D3/304, 306, 313, 314, 315; D7/635, D7/637, 641; D19/75, 77, 81, 90, 95, D19/101, 102, 107
CPC . A47G 29/08; B65D 1/00; B65D 1/22; B65D 1/24; B65D 1/38
See application file for complete search history.

(56) **References Cited**

U.S. PATENT DOCUMENTS

D296,116 S * 6/1988 Klodt D19/85
D297,693 S * 9/1988 Norstedt D6/553
D304,842 S * 11/1989 Barone D19/75
D317,178 S * 5/1991 Kheng D19/75
D332,631 S * 1/1993 Klodt D19/75
D385,112 S * 10/1997 Birnbaum D19/78
D455,459 S * 4/2002 Cheris D19/90

D502,509 S * 3/2005 DeCarlo D19/75
D542,533 S * 5/2007 Yang D3/313
D562,557 S * 2/2008 Lewis D3/313
D593,796 S * 6/2009 Kevan D34/1
D702,761 S * 4/2014 Foley D19/77
D799,831 S * 10/2017 Hsu D3/313
D819,268 S * 5/2018 Goodman D28/38
D848,151 S * 5/2019 Greenwood D3/313
D851,935 S * 6/2019 Best D3/313
D873,129 S * 1/2020 Huang D9/420

* cited by examiner

Primary Examiner — Kelley A Donnelly

(74) *Attorney, Agent, or Firm* — Pauly, DeVries Smith & Deffner LLC

(57) **CLAIM**

The ornamental design for an angled organizer bin, as shown and described.

DESCRIPTION

FIG. 1 is a perspective view of the angled organizer bin. FIG. 2 is a front elevational view of the angled organizer bin. FIG. 3 is a rear elevational view of the angled organizer bin. FIG. 4 is a right side elevational view of the angled organizer bin. FIG. 5 is a left side elevational view of the angled organizer bin. FIG. 6 is a top plan view of the angled organizer bin; and, FIG. 7 is a bottom plan view of the angled organizer bin. The broken lines in the drawings illustrate portions of the angled organizer bin that form no part of the claim.

1 Claim, 3 Drawing Sheets

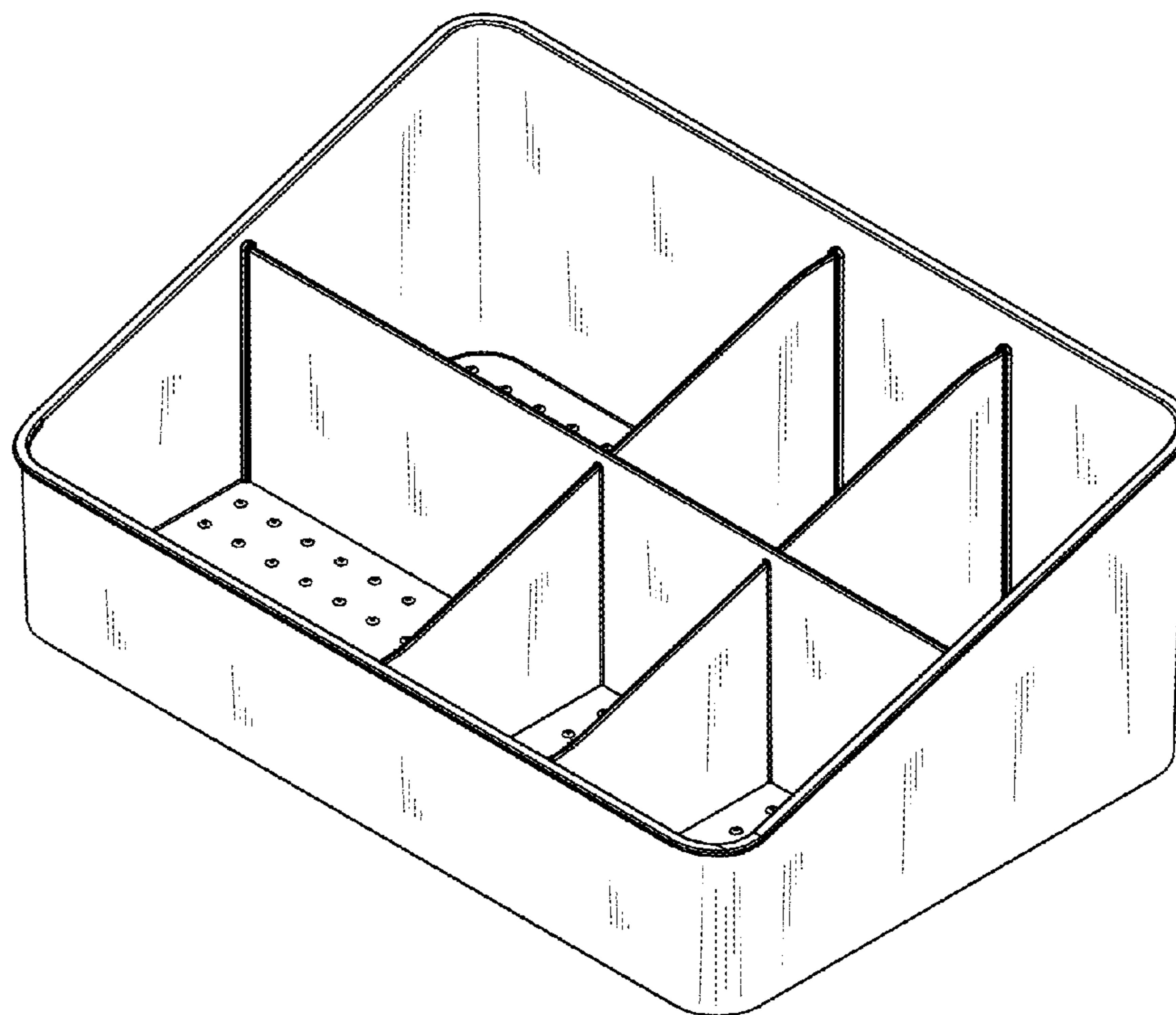

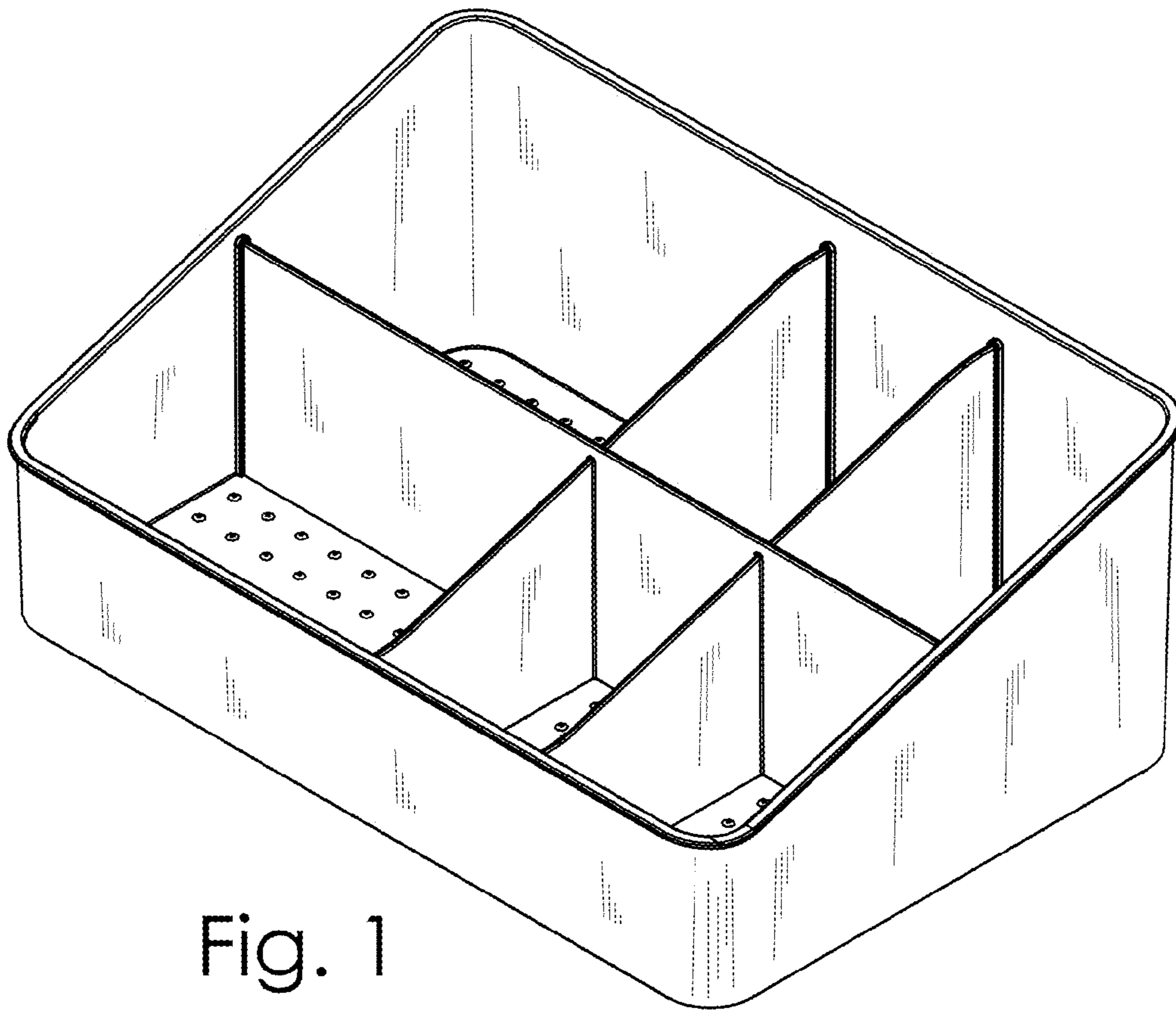

Fig. 1

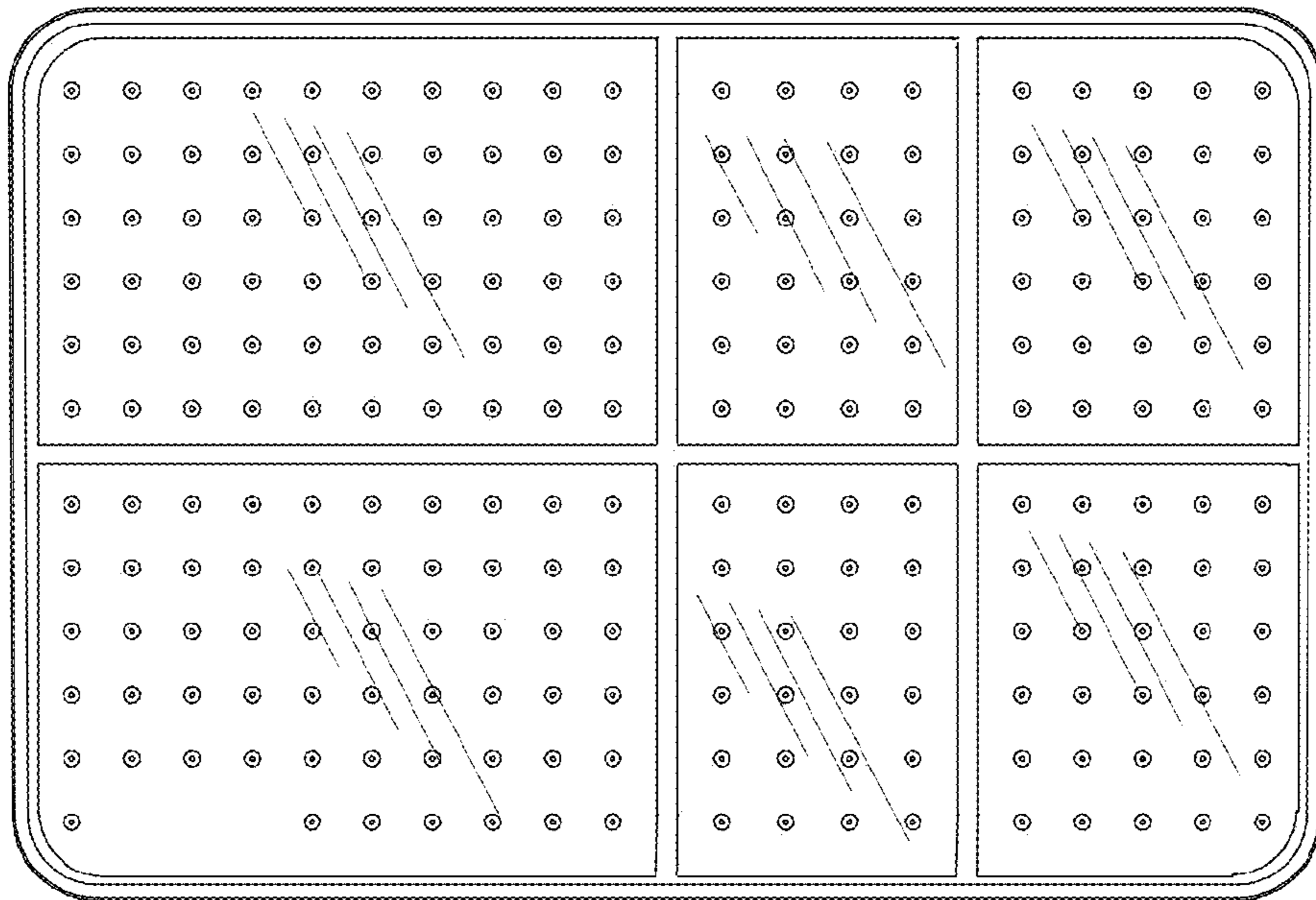

Fig. 2

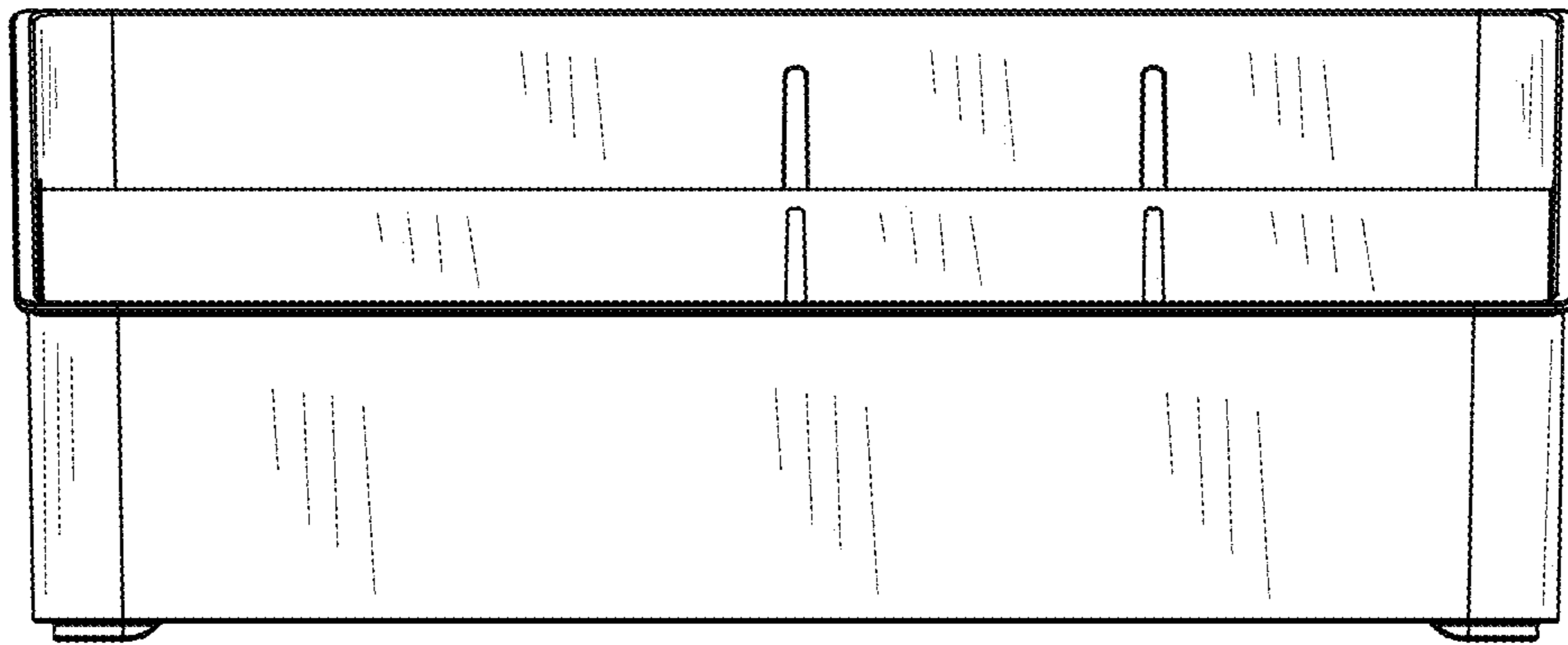

Fig. 3

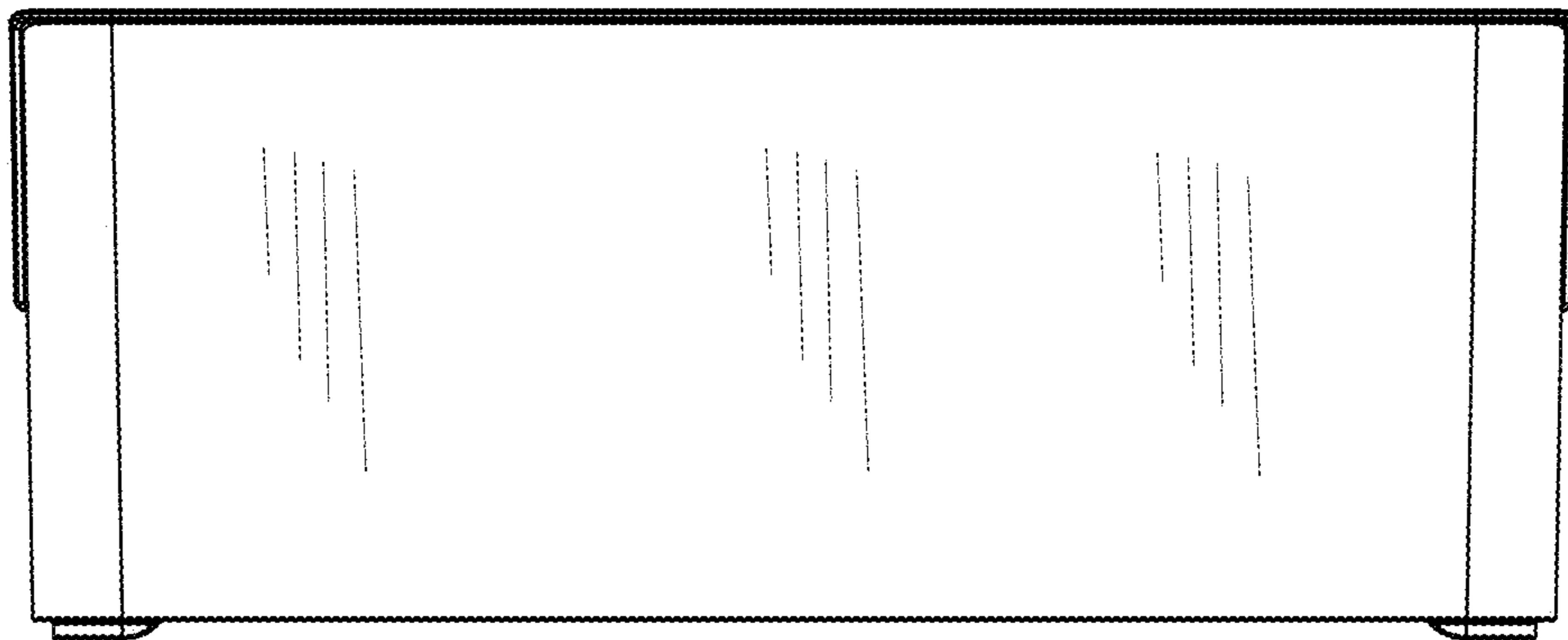

Fig. 4

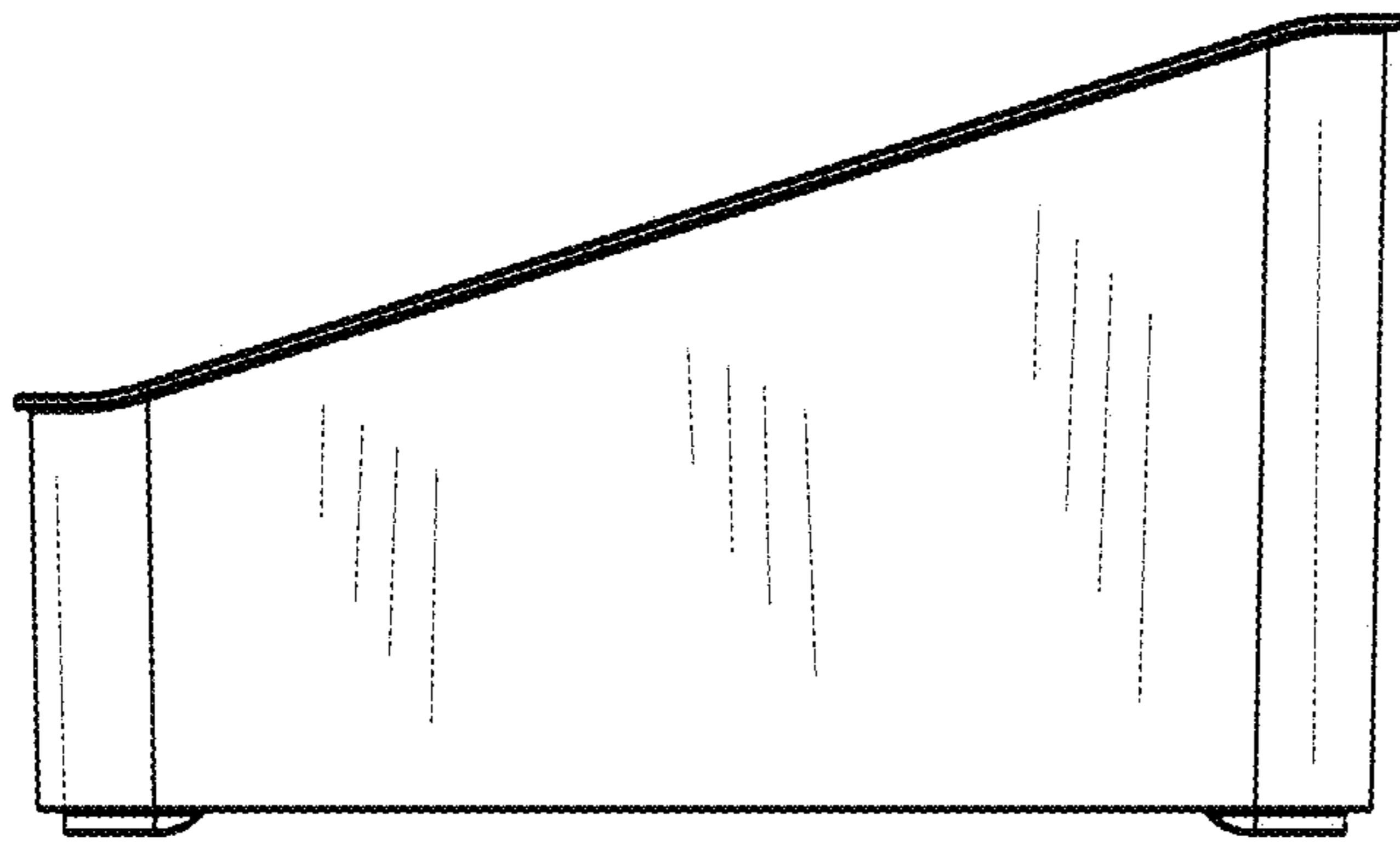

Fig. 5

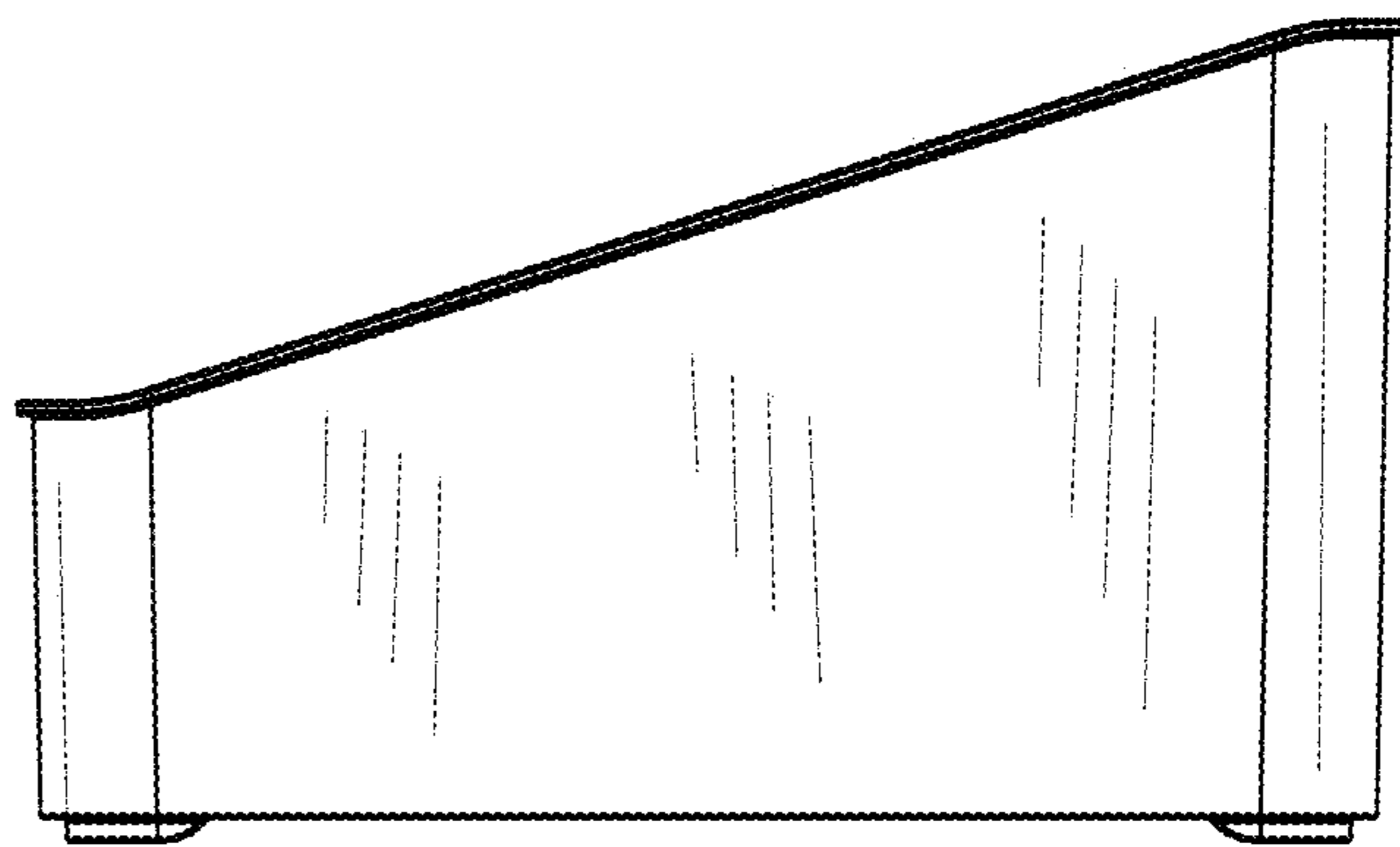

Fig. 6

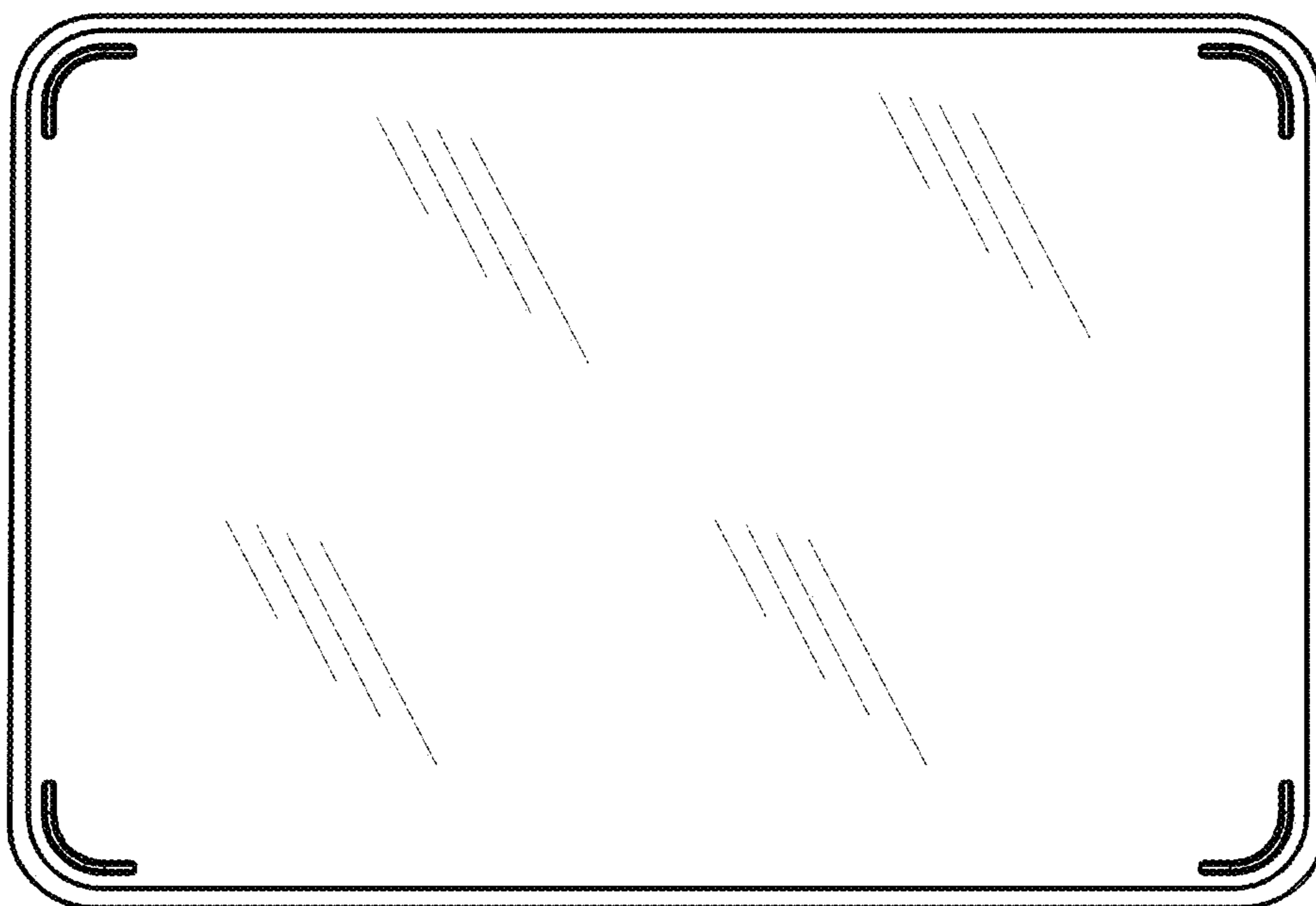

Fig. 7