



US00D887561S

(12) **United States Design Patent** (10) **Patent No.:** **US D887,561 S**  
**Cheng et al.** (45) **Date of Patent:** **\*\* Jun. 16, 2020**

(54) **CONVEX ARRAY ULTRASONIC PROBE**

FOREIGN PATENT DOCUMENTS

(71) Applicant: **EDAN INSTRUMENTS, INC.**,  
Shenzhen (CN)

KR 3020130013806 \* 3/2013  
KR 3020170042153 \* 9/2017

(72) Inventors: **Jiudong Cheng**, Shenzhen (CN); **Hua Luo**, Shenzhen (CN)

OTHER PUBLICATIONS

(73) Assignee: **EDAN INSTRUMENTS, INC.**,  
Shenzhen (CN)

Chapter 4. Probe Selection, Machine Controls, and Equipment. Online, published date unknown. Retrieved on Sep. 15, 2019 from URL: <https://accessanesthesiology.mhmedical.com/content.aspx?bookid=517&sectionid=41066790>.\*

(\*\*) Term: **15 Years**

*Primary Examiner* — Susan Bennett Hattan  
*Assistant Examiner* — Omeed Agilee

(21) Appl. No.: **29/663,586**

(22) Filed: **Sep. 17, 2018**

(57) **CLAIM**

(30) **Foreign Application Priority Data**

The ornamental design for a convex array ultrasonic probe, as shown and described.

Jul. 10, 2018 (CN) ..... 2018 3 0369577

**DESCRIPTION**

(51) **LOC (12) Cl.** ..... **24-02**

(52) **U.S. Cl.**  
USPC ..... **D24/187**

(58) **Field of Classification Search**  
USPC ..... D24/133, 137, 138, 141, 158, 160, 164,  
D24/165, 167, 170, 186, 187, 200;  
D10/57, 60, 78, 80  
CPC ... A61B 5/0095; A61B 8/4444; A61B 8/4455;  
G01S 7/5208  
See application file for complete search history.

FIG. 1 is a perspective view of a convex array ultrasonic probe;  
FIG. 2 is a front view of the convex array ultrasonic probe;  
FIG. 3 is a rear view of the convex array ultrasonic probe;  
FIG. 4 is a left side view of the convex array ultrasonic probe;  
FIG. 5 is a right side view of the convex array ultrasonic probe;  
FIG. 6 is a top view of the convex array ultrasonic probe;  
FIG. 7 is a bottom view of the convex array ultrasonic probe;  
FIG. 8 is an enlarged perspective view of detail 8 circumscribed within FIG. 1;  
FIG. 9 is an enlarged view of detail 9 circumscribed within FIG. 7; and,  
FIG. 10 is an enlarged view of detail 10 circumscribed within FIG. 7.  
The broken lines in the drawings depict portions of the convex array ultrasonic probe that form no part of the claimed design.

(56) **References Cited**

U.S. PATENT DOCUMENTS

D392,044 S \* 3/1998 Mesaros ..... D24/186  
D555,252 S \* 11/2007 Kitayama ..... D24/186  
D681,820 S \* 5/2013 Shinohara ..... D24/186  
D681,823 S \* 5/2013 Shinohara ..... D24/186  
D682,433 S \* 5/2013 Shinohara ..... D24/186  
D703,330 S \* 4/2014 Saeki ..... D24/187  
D703,818 S \* 4/2014 Moon ..... D24/187

(Continued)

**1 Claim, 10 Drawing Sheets**

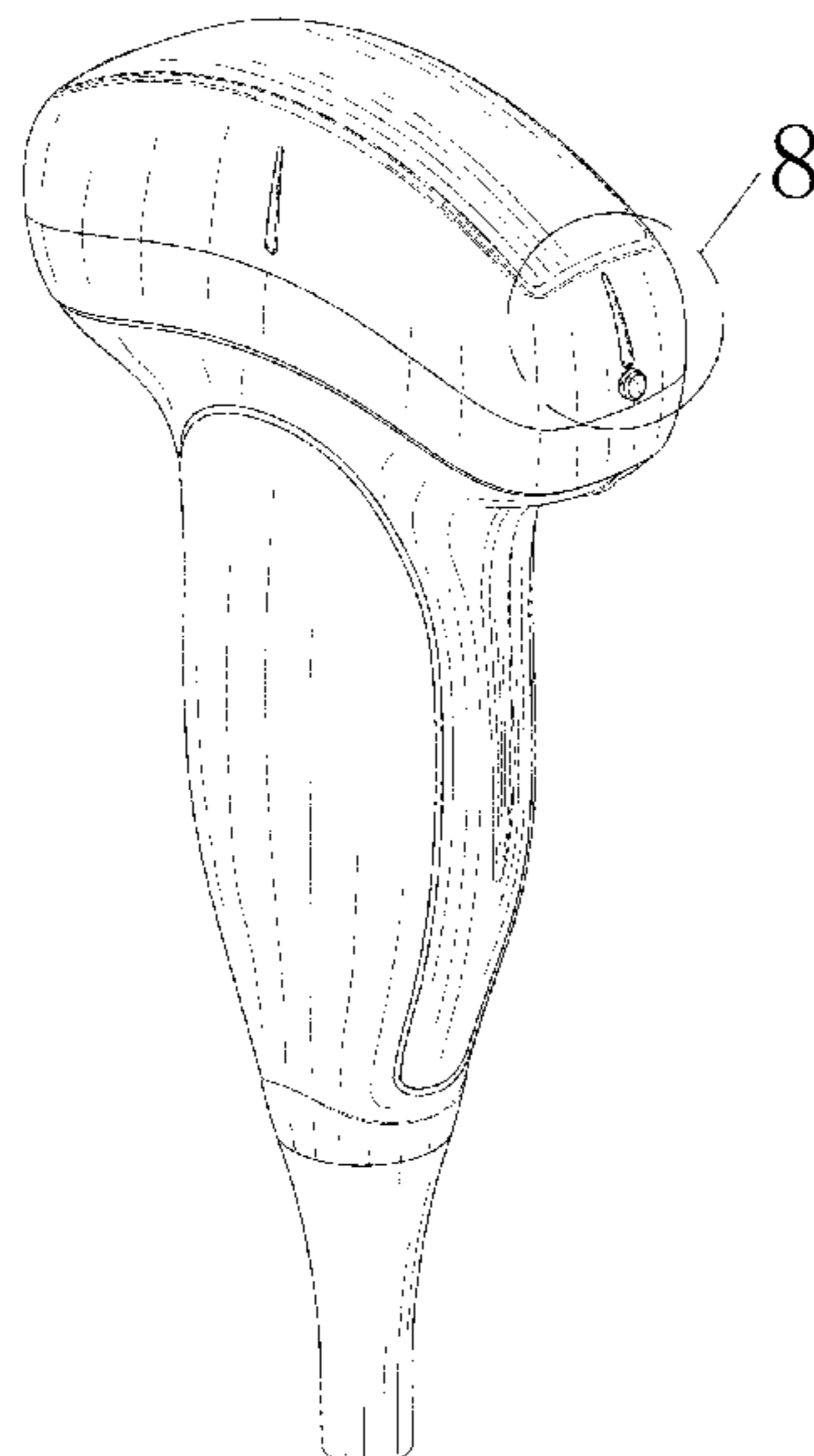

(56)

**References Cited**

U.S. PATENT DOCUMENTS

D704,341 S *	5/2014	Ryu .....	D24/187
D705,433 S *	5/2014	Ran .....	D24/187
D745,972 S *	12/2015	Kitayama .....	D24/187
D749,224 S *	2/2016	Iritani .....	D24/187
D767,150 S *	9/2016	Moon .....	D24/186
D811,608 S *	2/2018	Kitayama .....	D24/187
2018/0125462 A1 *	5/2018	Won .....	A61B 8/4455

\* cited by examiner

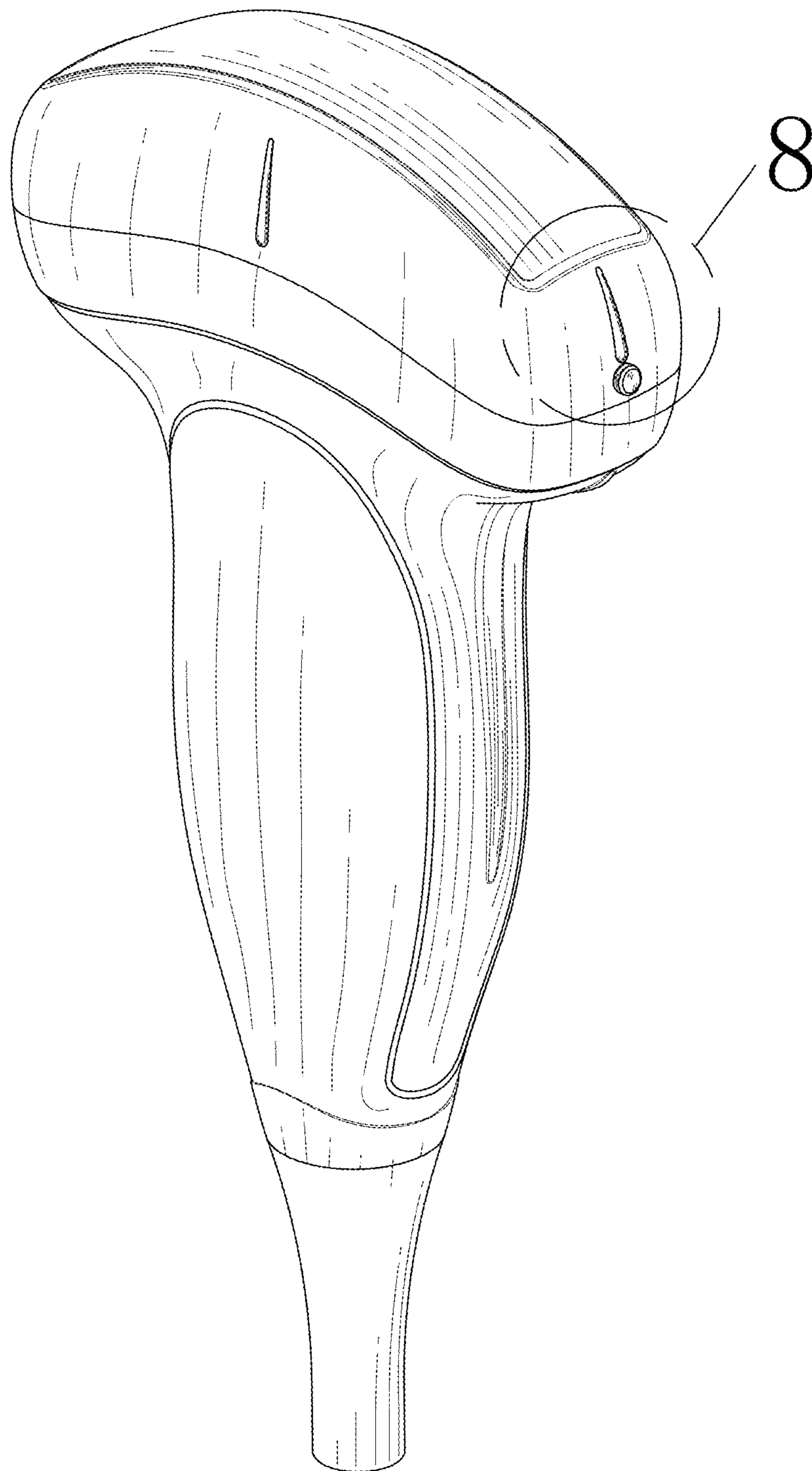

FIG. 1

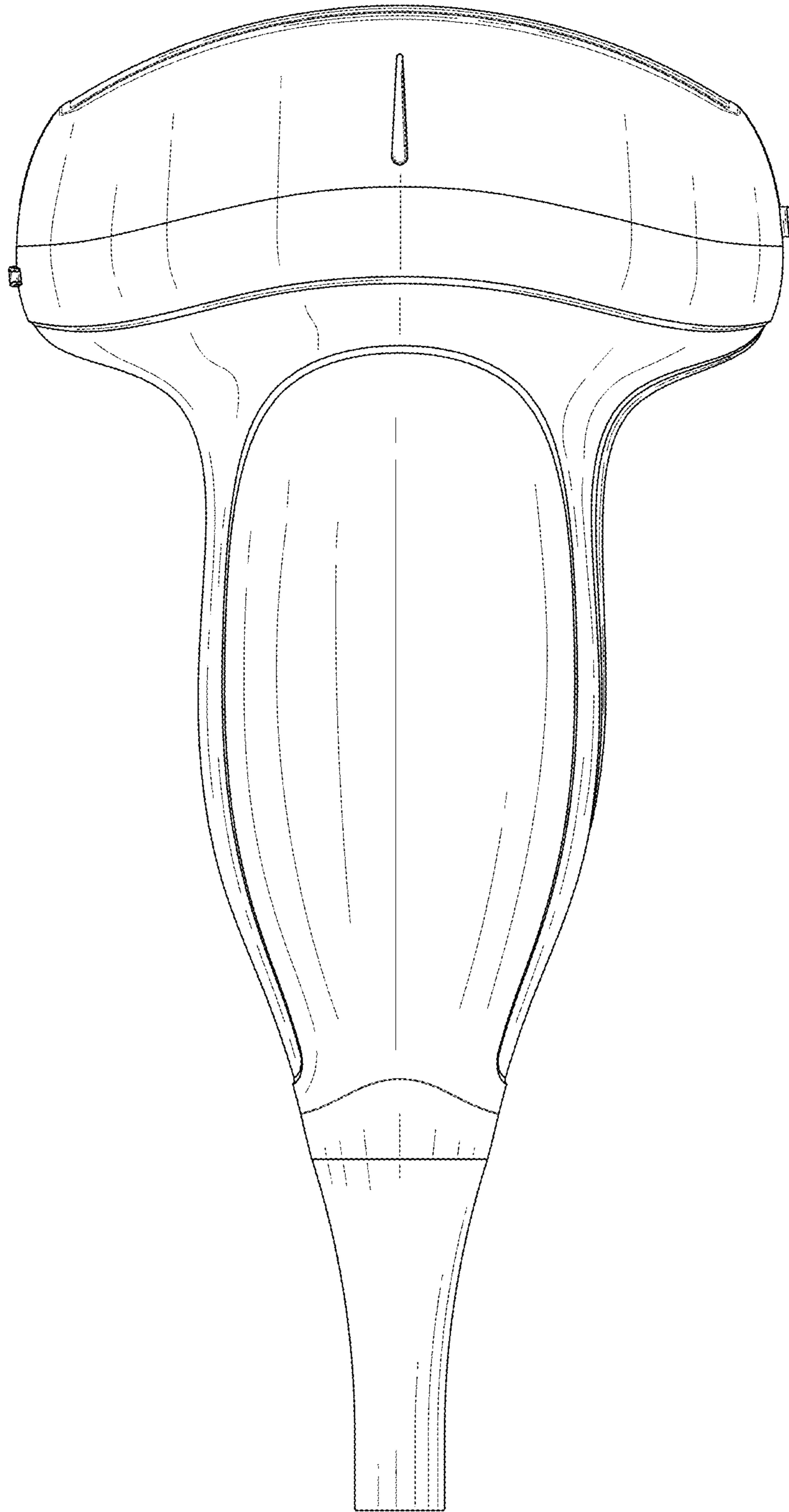

FIG. 2

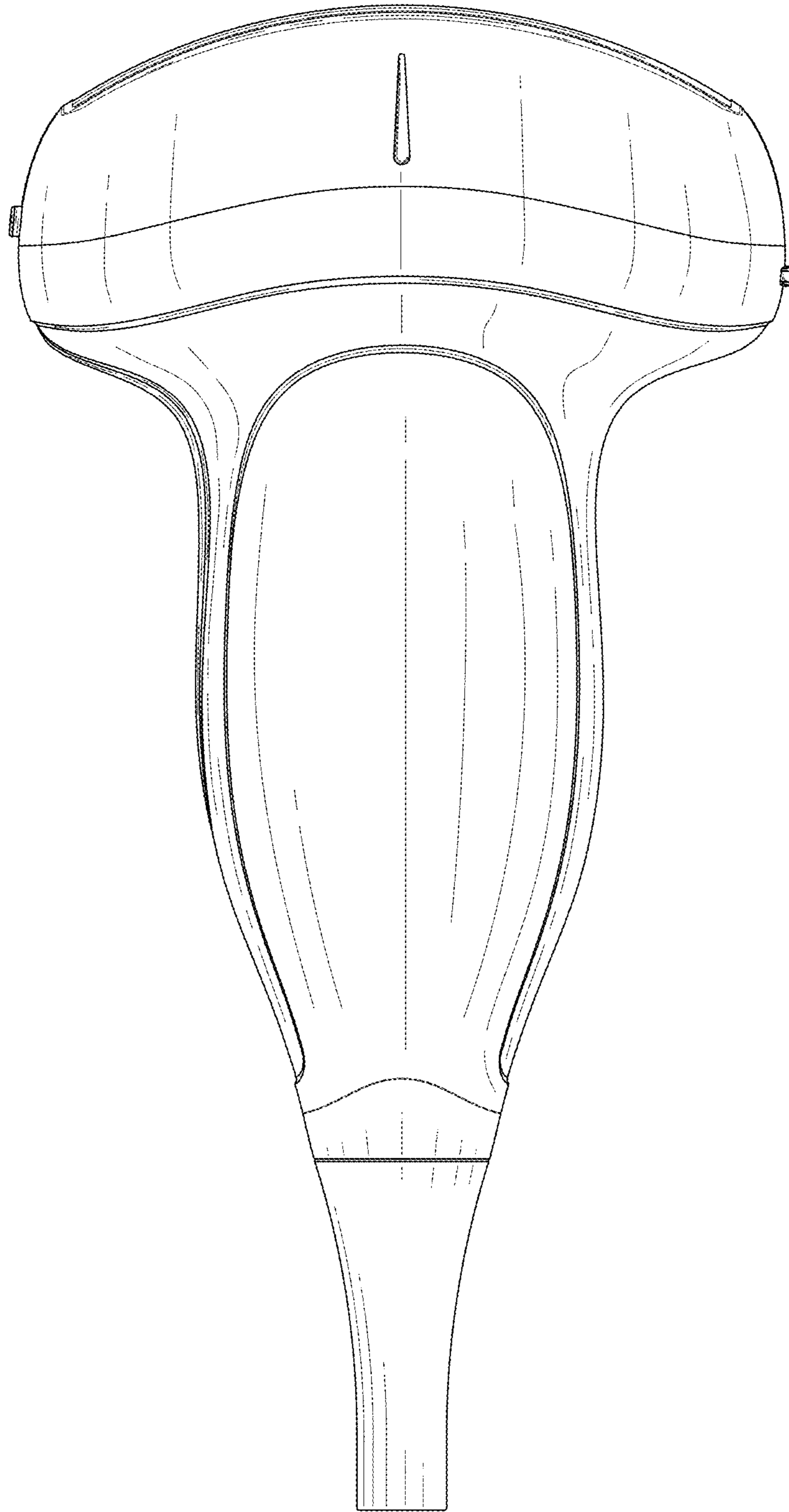

FIG. 3

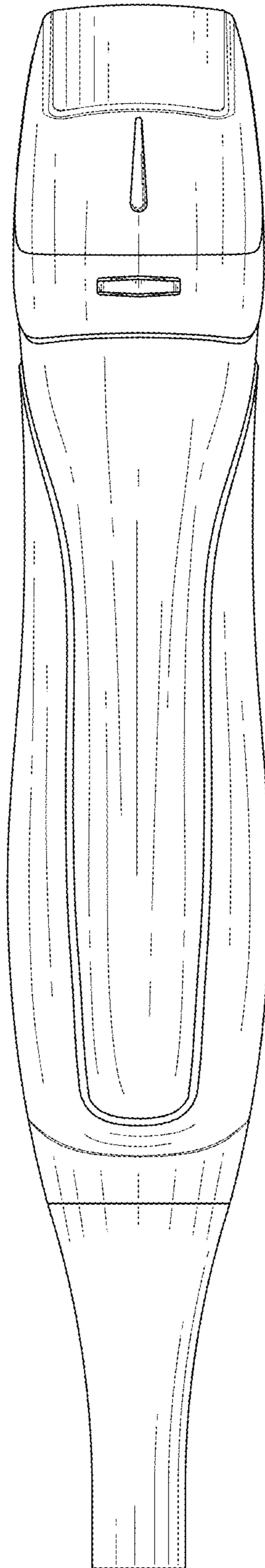

FIG. 4



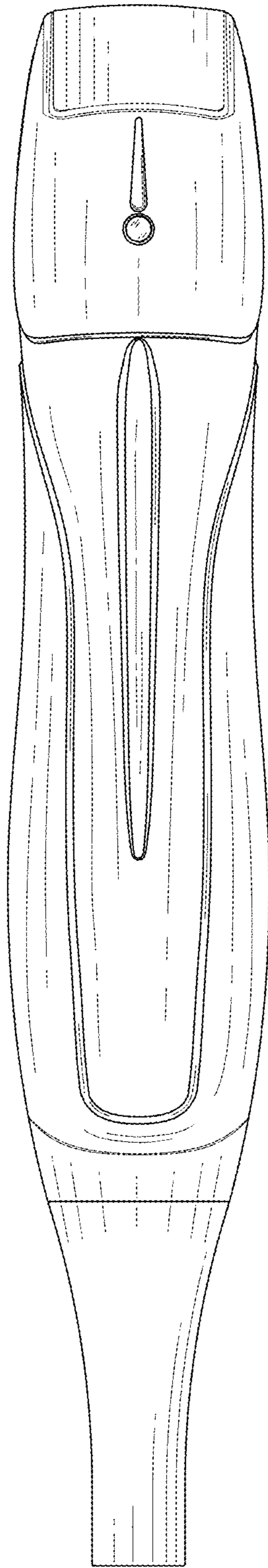

FIG. 5

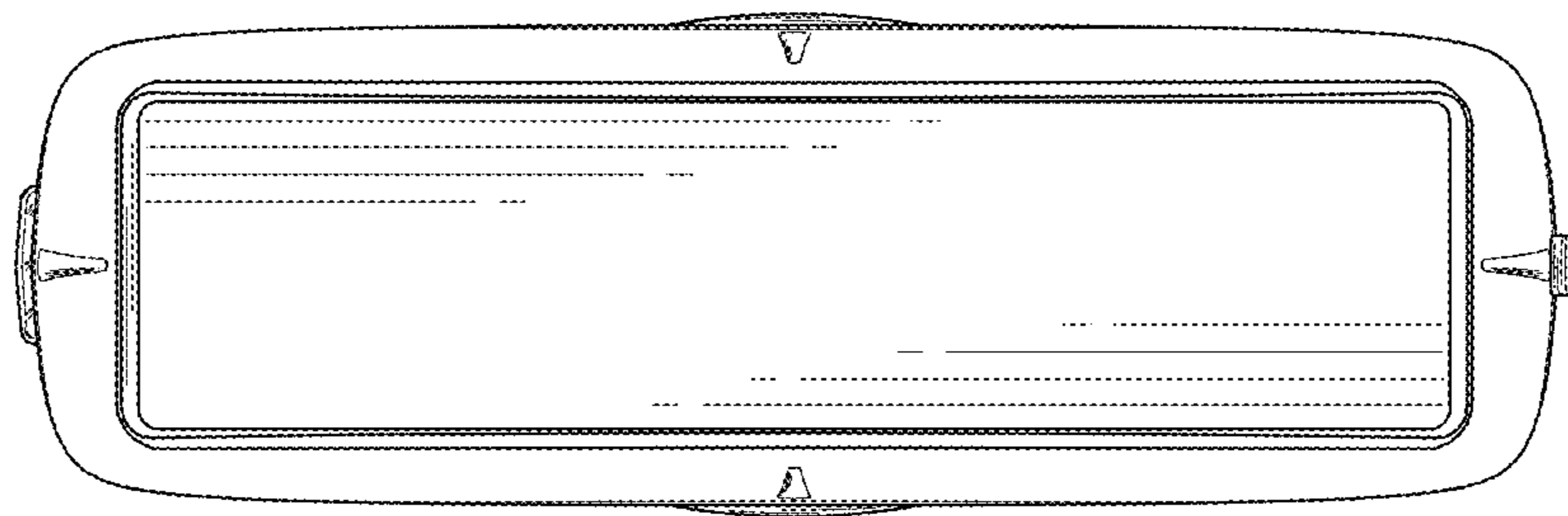

FIG. 6



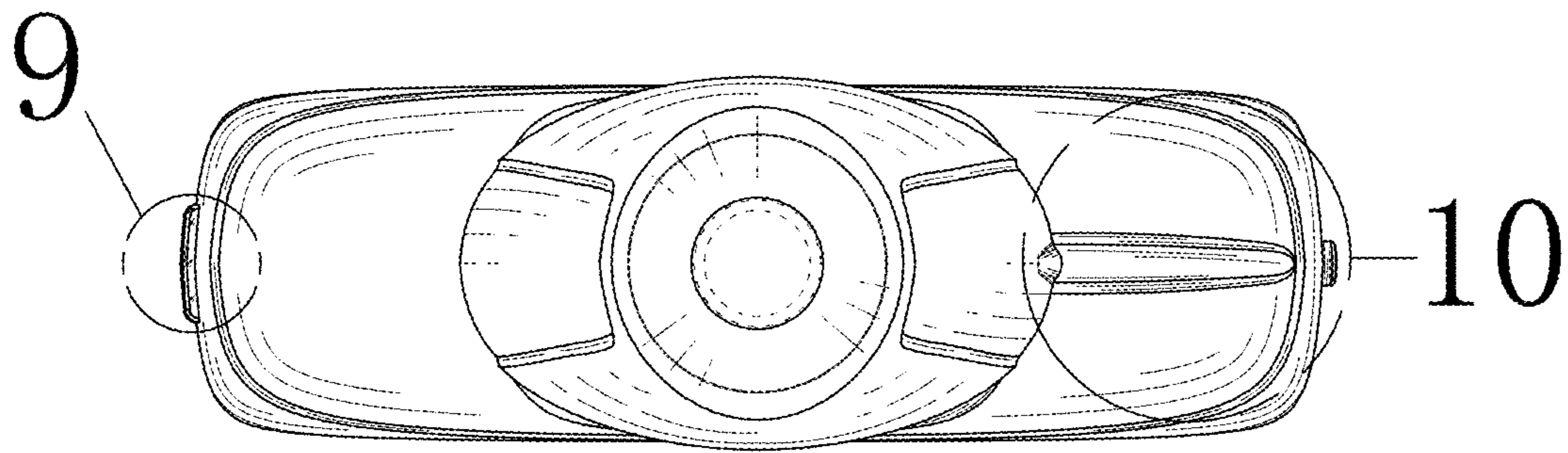

FIG. 7

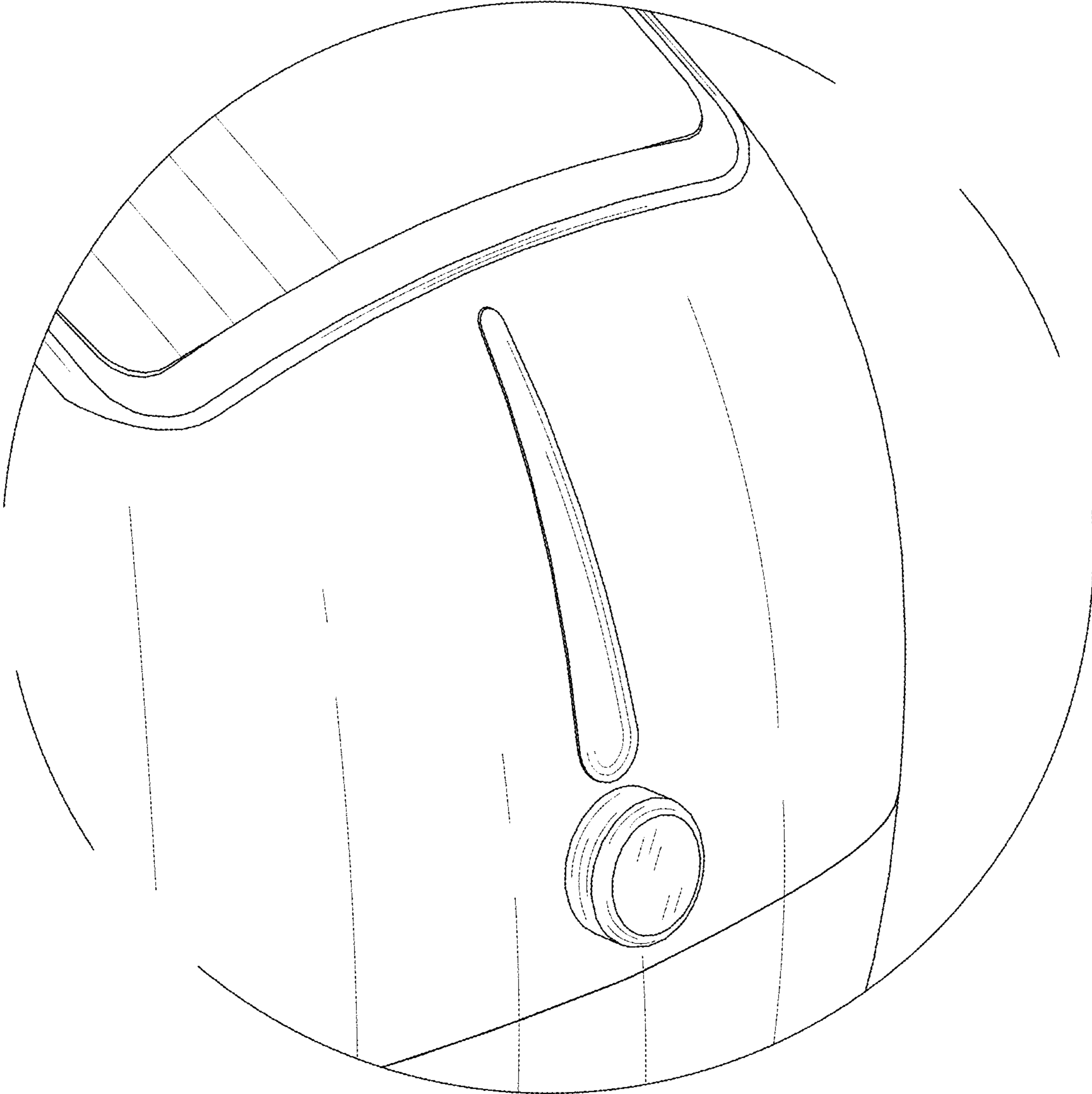

FIG. 8

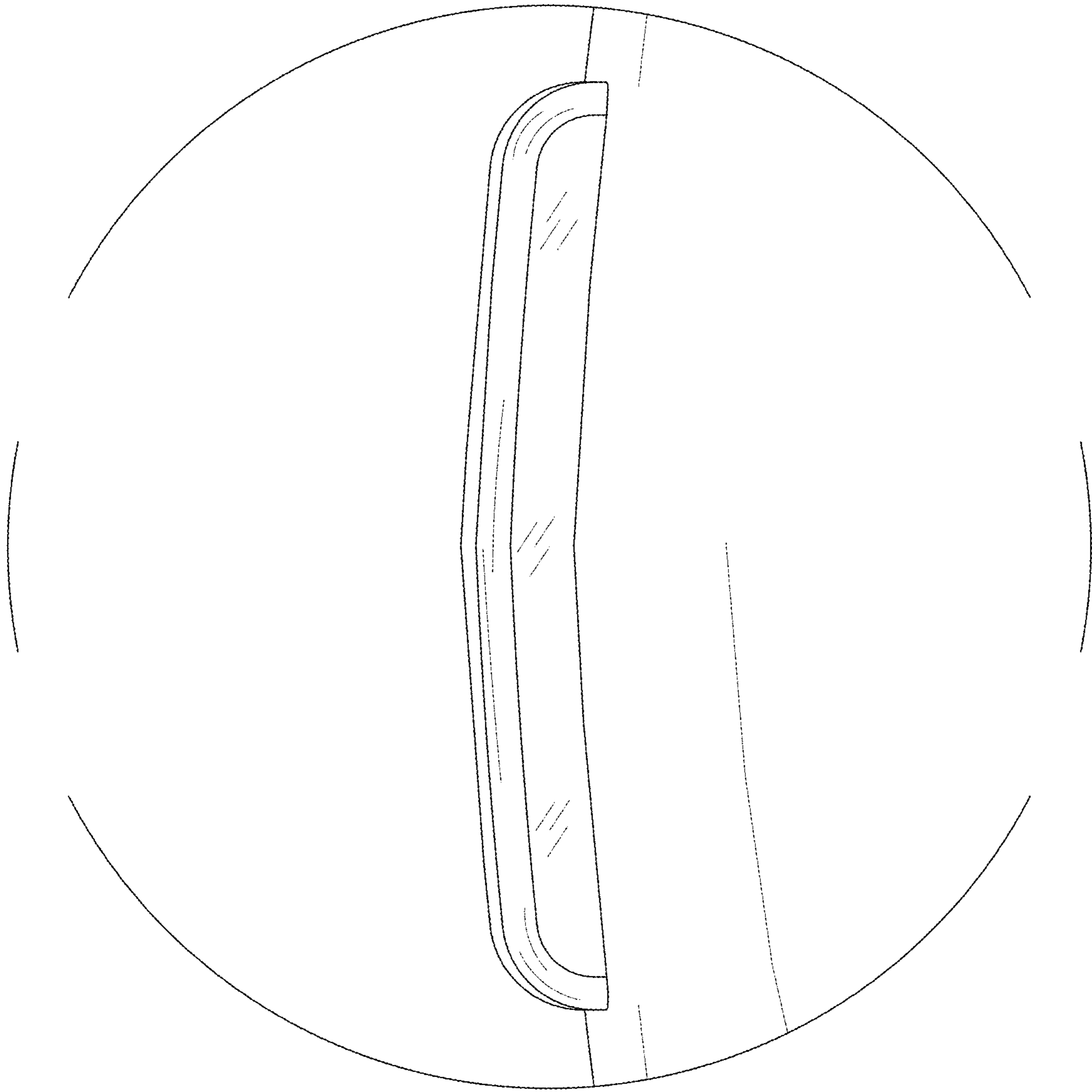

FIG. 9

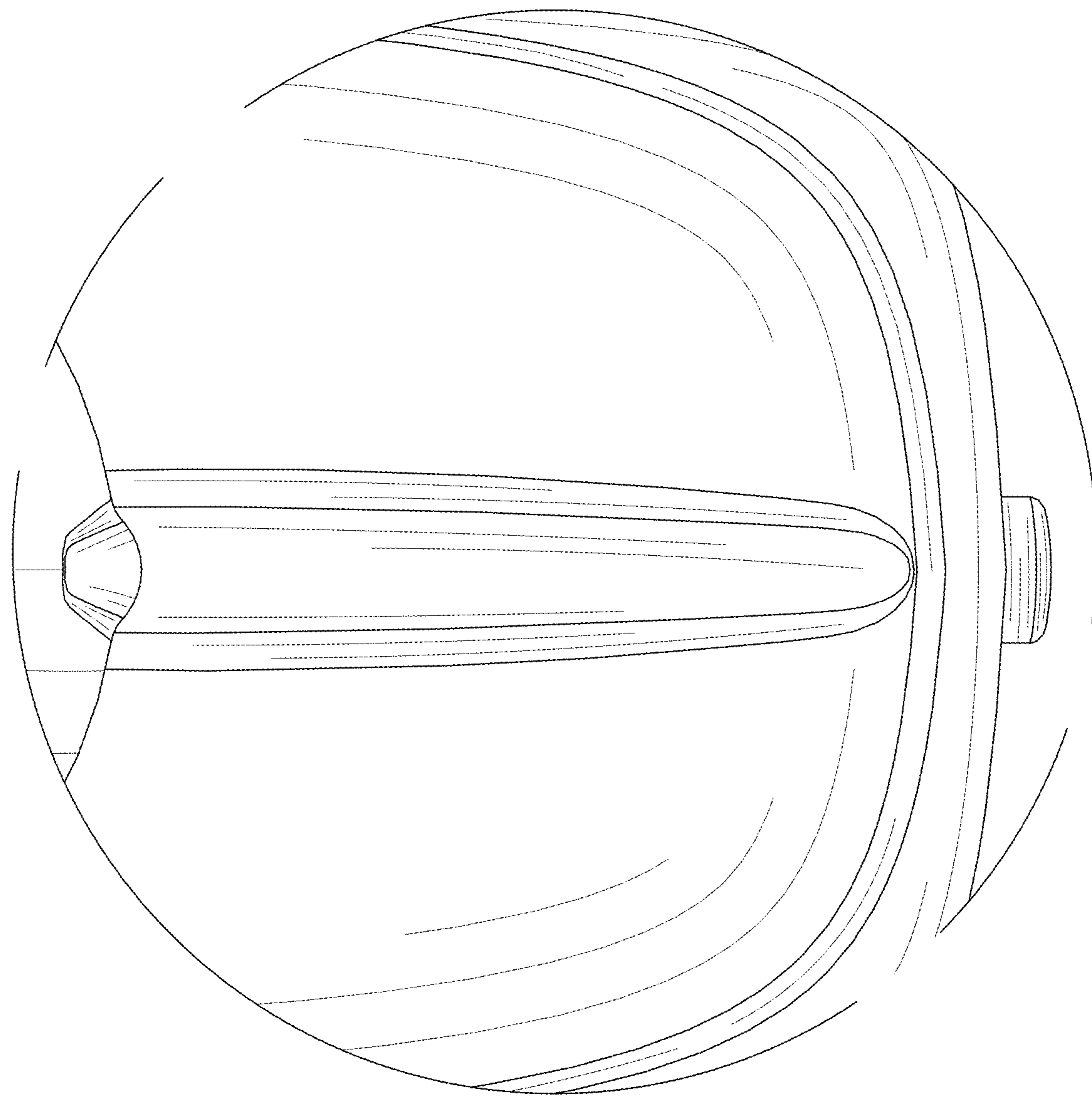

FIG. 10