



US00D887538S

(12) **United States Design Patent**
Emery

(10) **Patent No.:** **US D887,538 S**
(45) **Date of Patent:** **** Jun. 16, 2020**

(54) **WATER HEATER INSERT**

(71) Applicant: **ECONOMICO, LLC**, Boynton Beach, FL (US)

(72) Inventor: **Christopher Emery**, Boynton Beach, FL (US)

(73) Assignee: **ECONOMICO, LLC**, Boynton Beach, FL (US)

(**) Term: **15 Years**

(21) Appl. No.: **29/655,500**

(22) Filed: **Jul. 3, 2018**

(51) **LOC (12) Cl.** **23-03**

(52) **U.S. Cl.**
USPC **D23/322**

(58) **Field of Classification Search**
USPC D23/314, 315, 316, 318, 319, 320, 321, D23/322, 323
CPC A47J 31/542; F24H 1/16; F24H 9/2028
See application file for complete search history.

(56) **References Cited**

U.S. PATENT DOCUMENTS

- D532,499 S * 11/2006 Nakagawa D23/323
- D826,485 S * 8/2018 Maher D30/199
- 2010/0092163 A1* 4/2010 Yeung F24H 1/106
392/441
- 2011/0259203 A1* 10/2011 Mograbi A47J 31/46
99/288

(Continued)

Primary Examiner — T Chase Nelson
Assistant Examiner — Ania Aman

(74) *Attorney, Agent, or Firm* — Golab Intellectual Property; Mario Sergio Golab

(57) **CLAIM**

The ornamental design for a water heater insert, as shown and described.

DESCRIPTION

FIG. 1 is a top view of the water heater insert assembly; FIG. 2 is a bottom view of the water heater insert assembly; FIG. 3 is a front view of the water heater insert assembly; FIG. 4 is a rear view of the water heater insert assembly; FIG. 5 is a left side view of the water heater insert assembly; FIG. 6 is a right side view of the water heater insert assembly; FIG. 7 is a bottom perspective view of the water heater insert assembly; FIG. 8 is a bottom perspective view of the disassembled water heater insert comprising a base and a cover plate; FIG. 9 is a top view of the water heater insert base; FIG. 10 is a bottom view of the water heater insert base; FIG. 11 is a front view of the water heater insert base; FIG. 12 is a rear view of the water heater insert base; FIG. 13 is a left side view of the water heater insert base; FIG. 14 is a right side view of the water heater insert base; FIG. 15 is a bottom perspective view of the water heater insert base; FIG. 16 is a top view of the water heater insert cover plate; FIG. 17 is a bottom view of the water heater insert cover plate; FIG. 18 is a front view of the water heater insert cover plate; FIG. 19 is a rear view of the water heater insert cover plate; FIG. 20 is a left side view of the water heater insert cover plate; FIG. 21 is a right side view of the water heater insert cover plate; and, FIG. 22 is a top perspective view of the water heater insert cover plate.

1 Claim, 13 Drawing Sheets

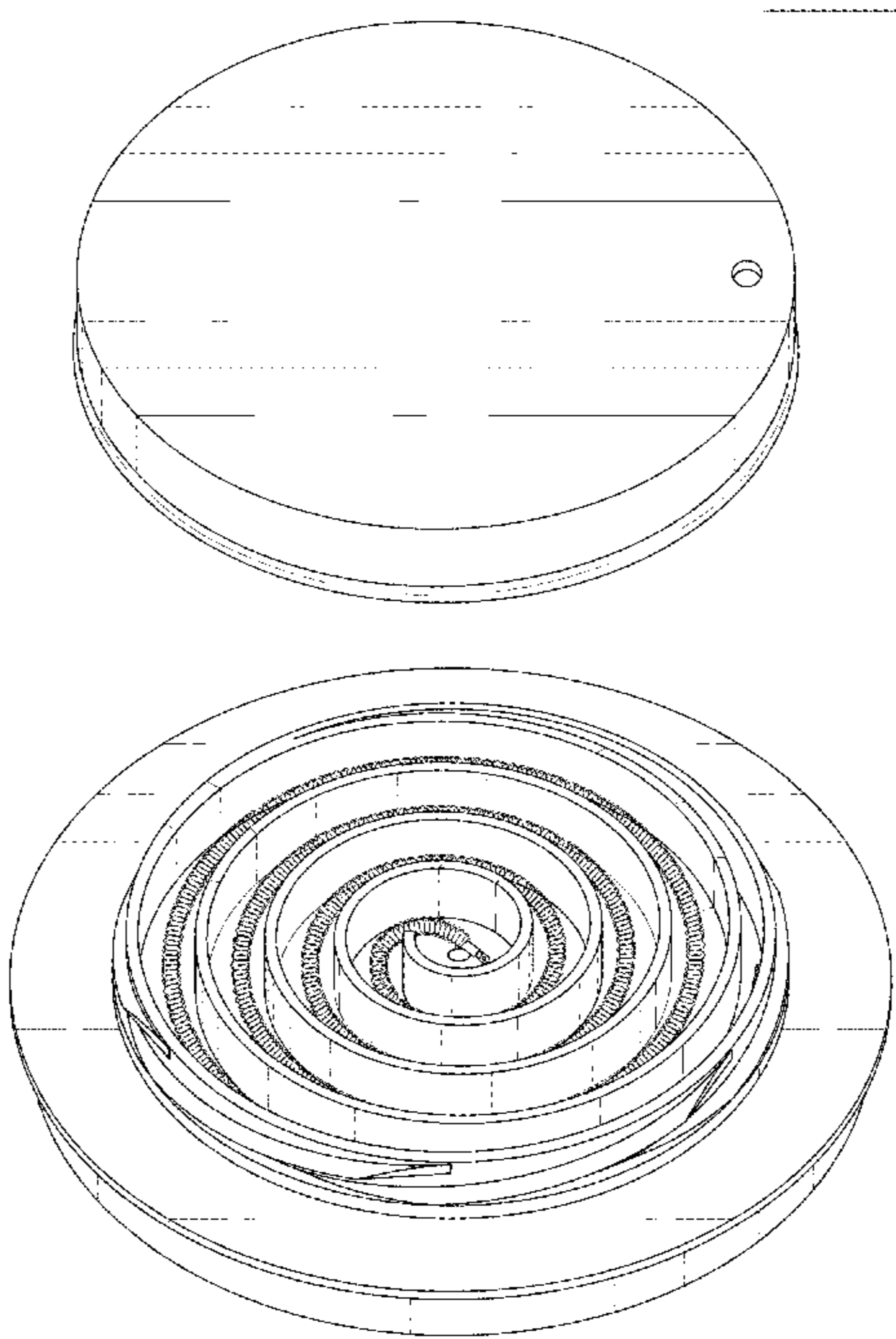

(56)

References Cited

U.S. PATENT DOCUMENTS

2013/0055902 A1* 3/2013 Berto A47J 31/542
99/281
2013/0168379 A1* 7/2013 Deenen F24H 1/121
219/443.1
2018/0135279 A1* 5/2018 Liu F24H 9/2007
2019/0346175 A1* 11/2019 Hofer H05B 1/0283
2019/0372137 A1* 12/2019 Planque F24H 1/162

* cited by examiner

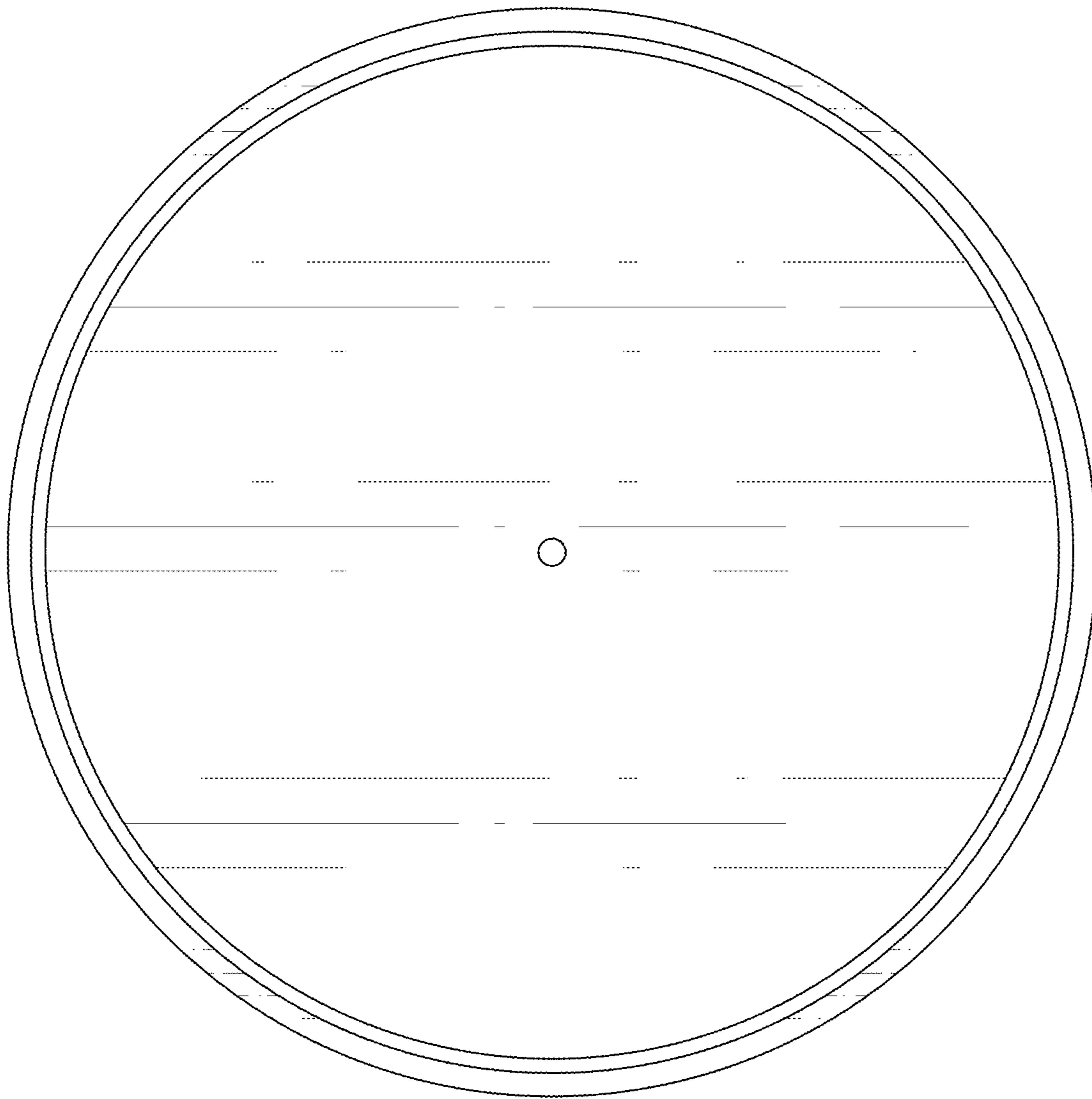

FIG. 1

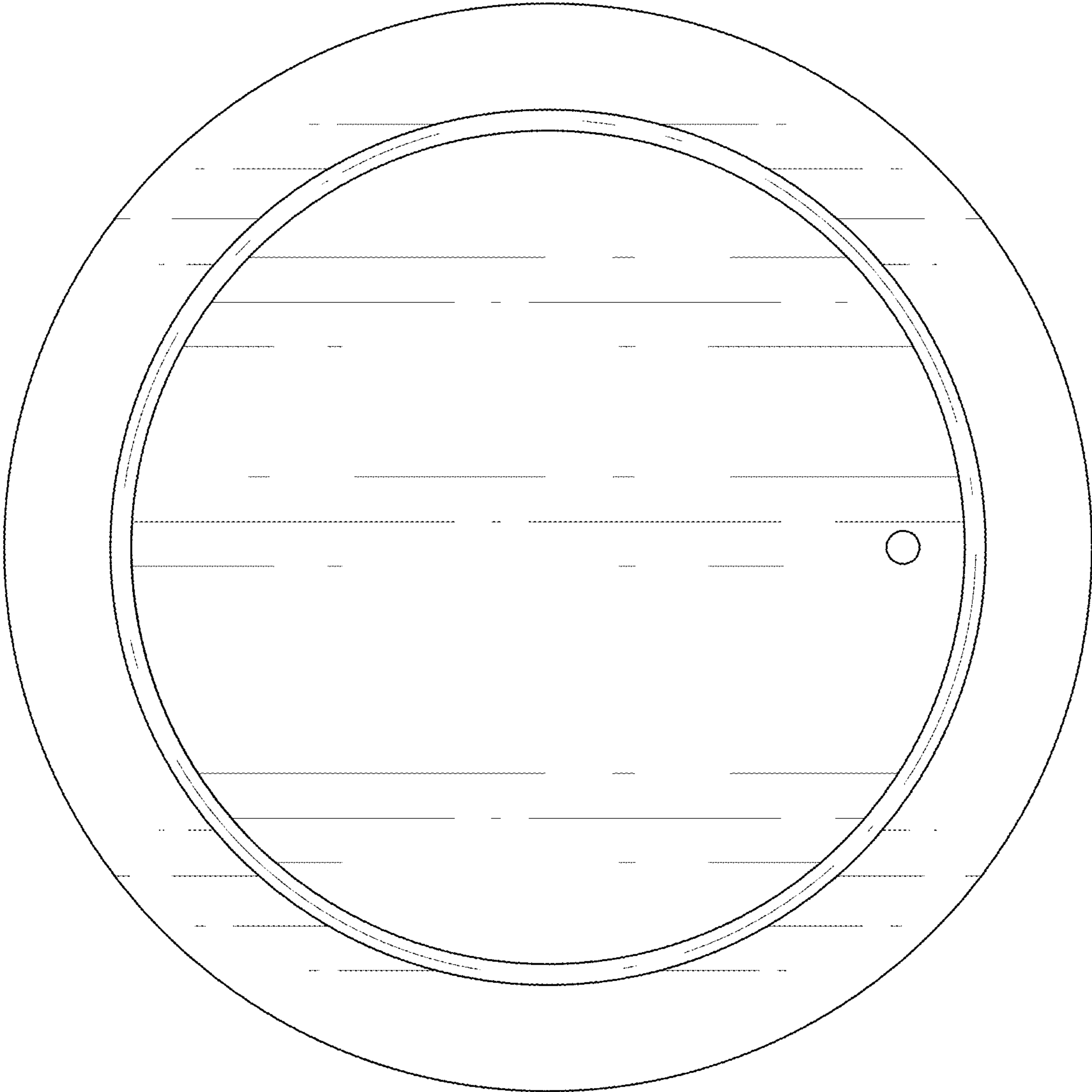

FIG. 2

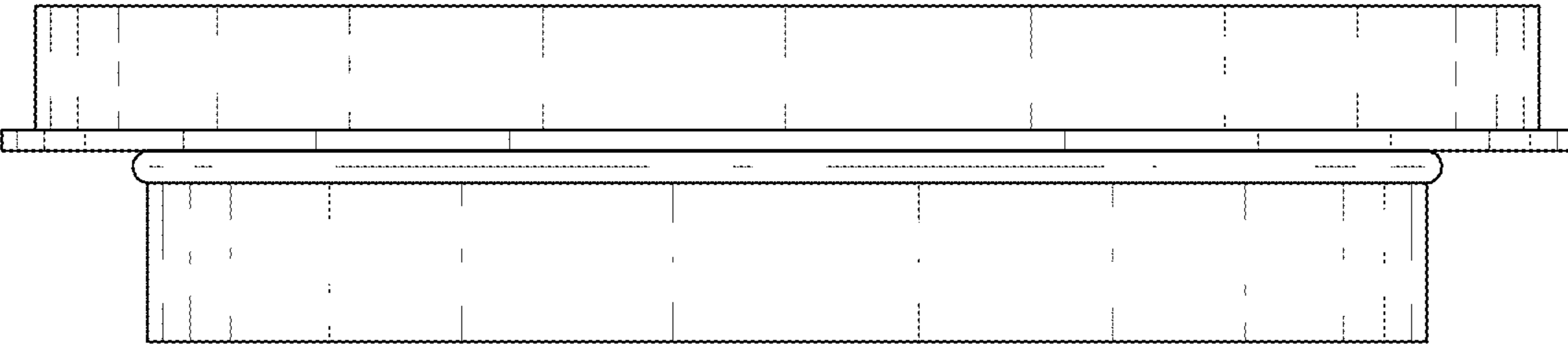

FIG. 3



FIG. 4

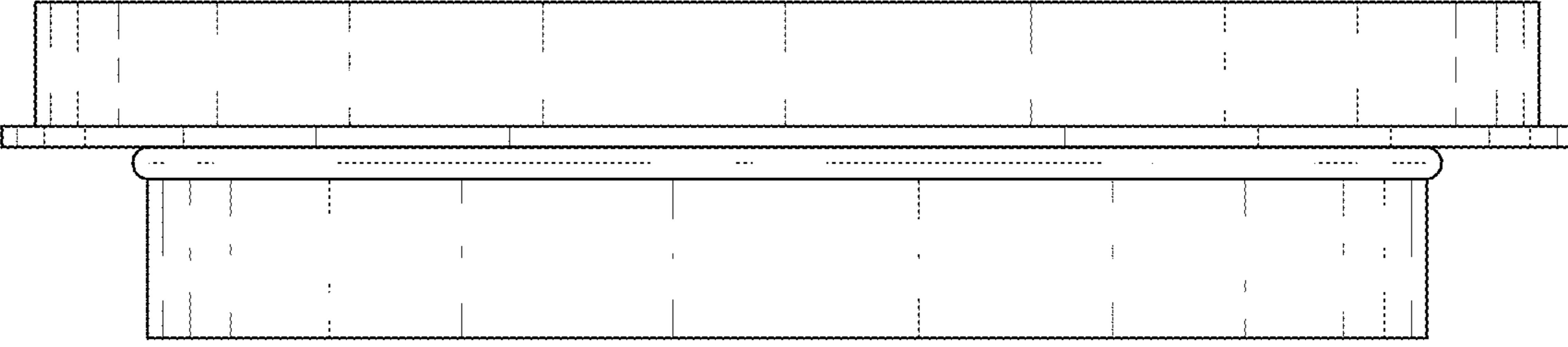

FIG. 5

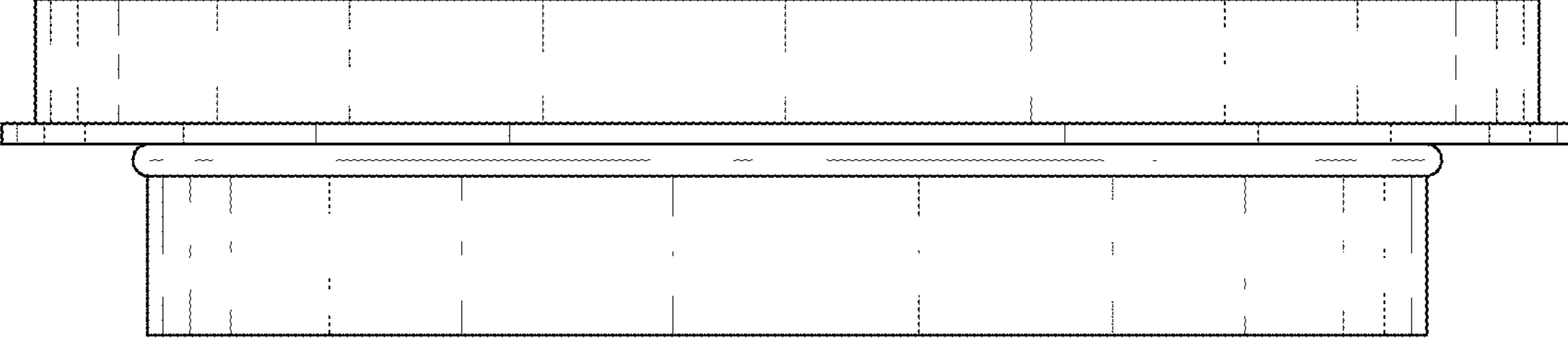

FIG. 6

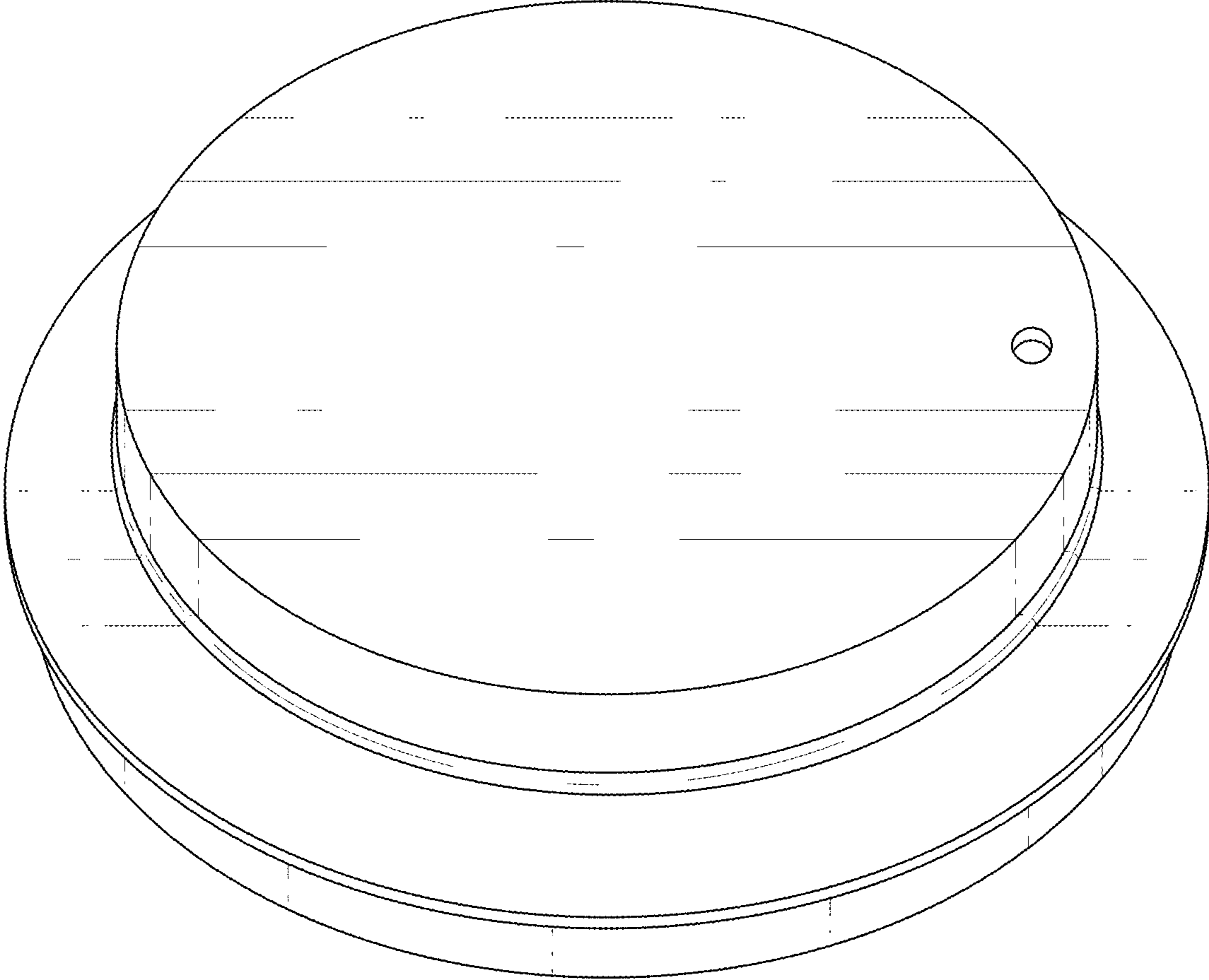

FIG. 7

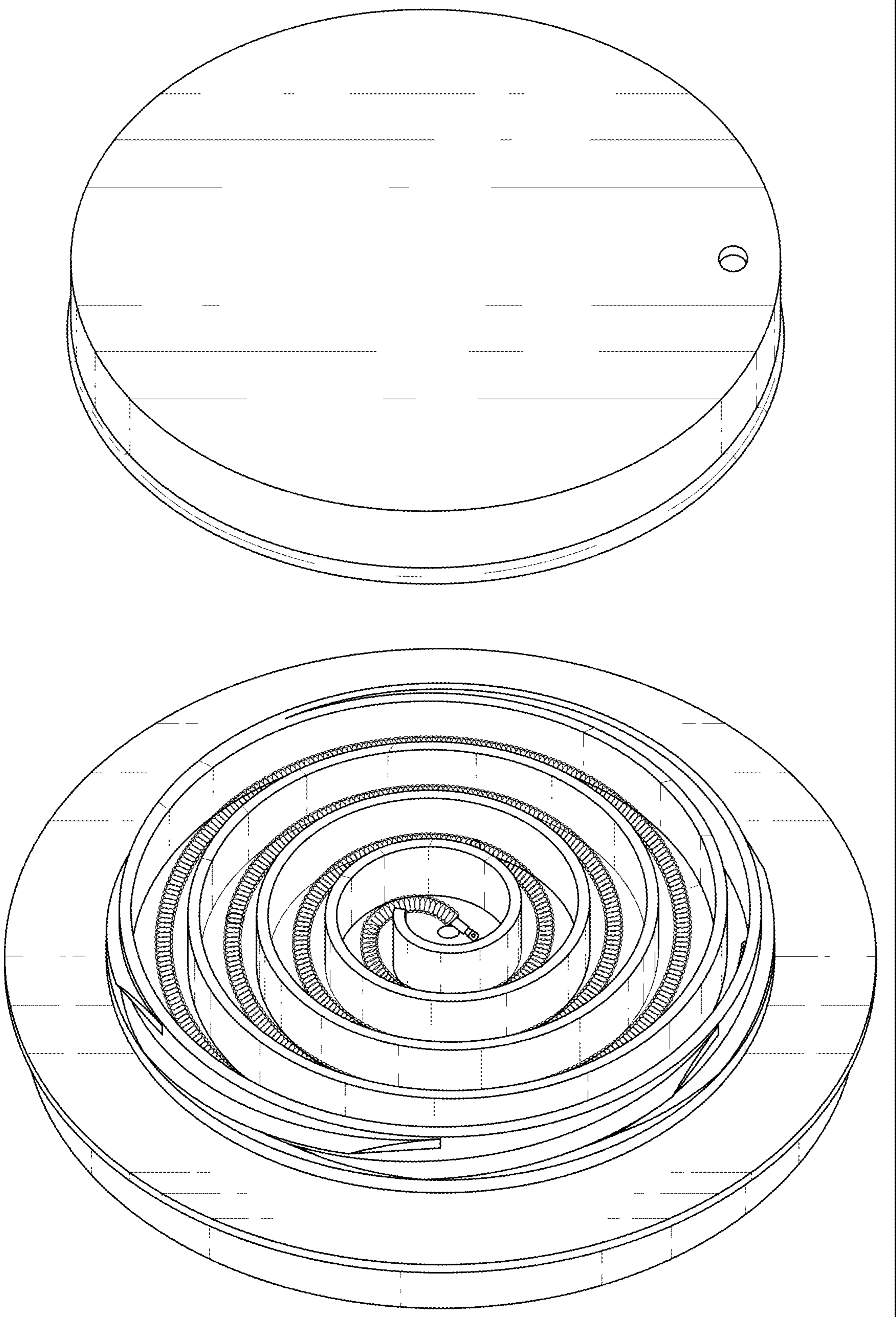

FIG. 8

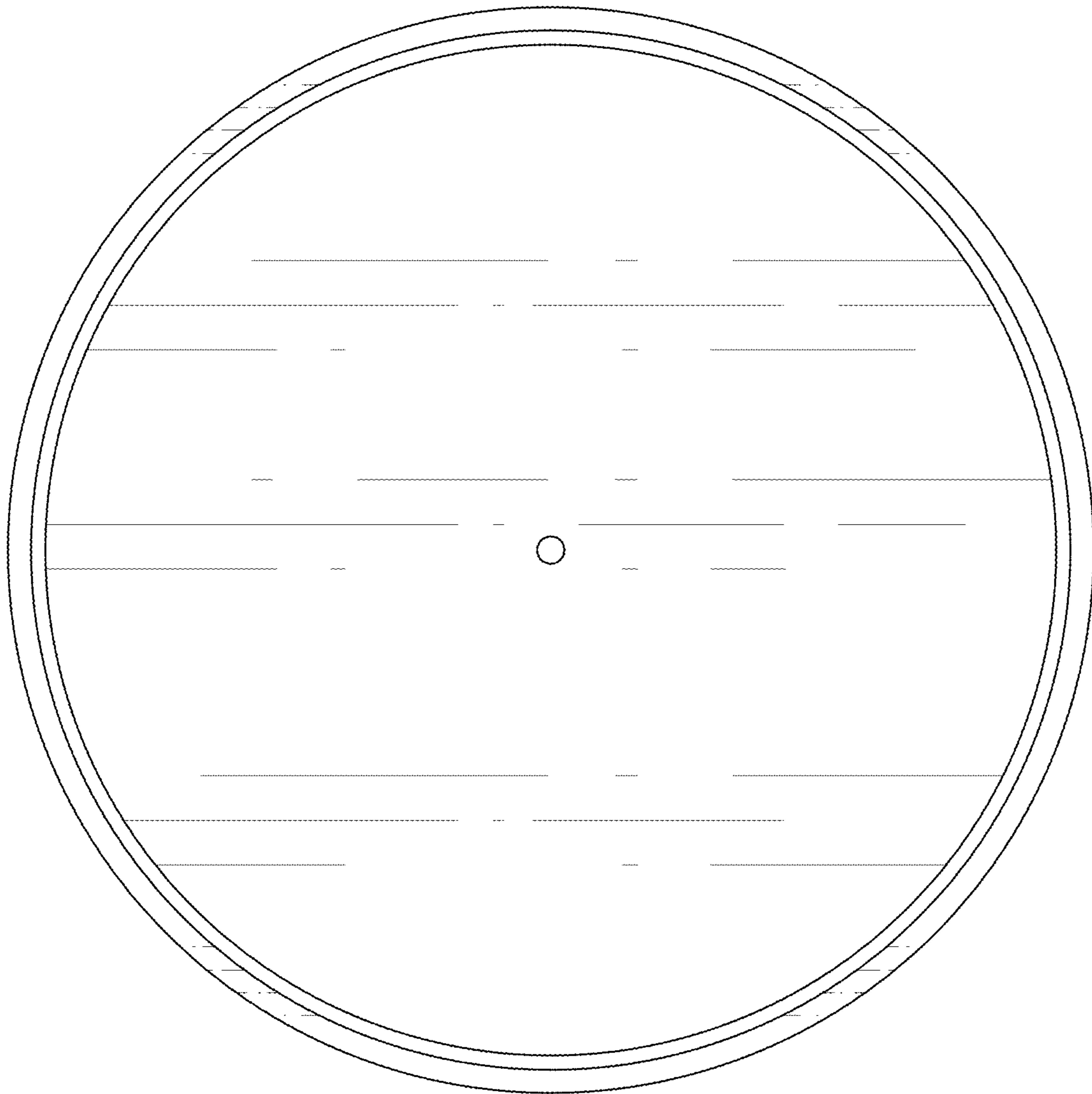

FIG. 9

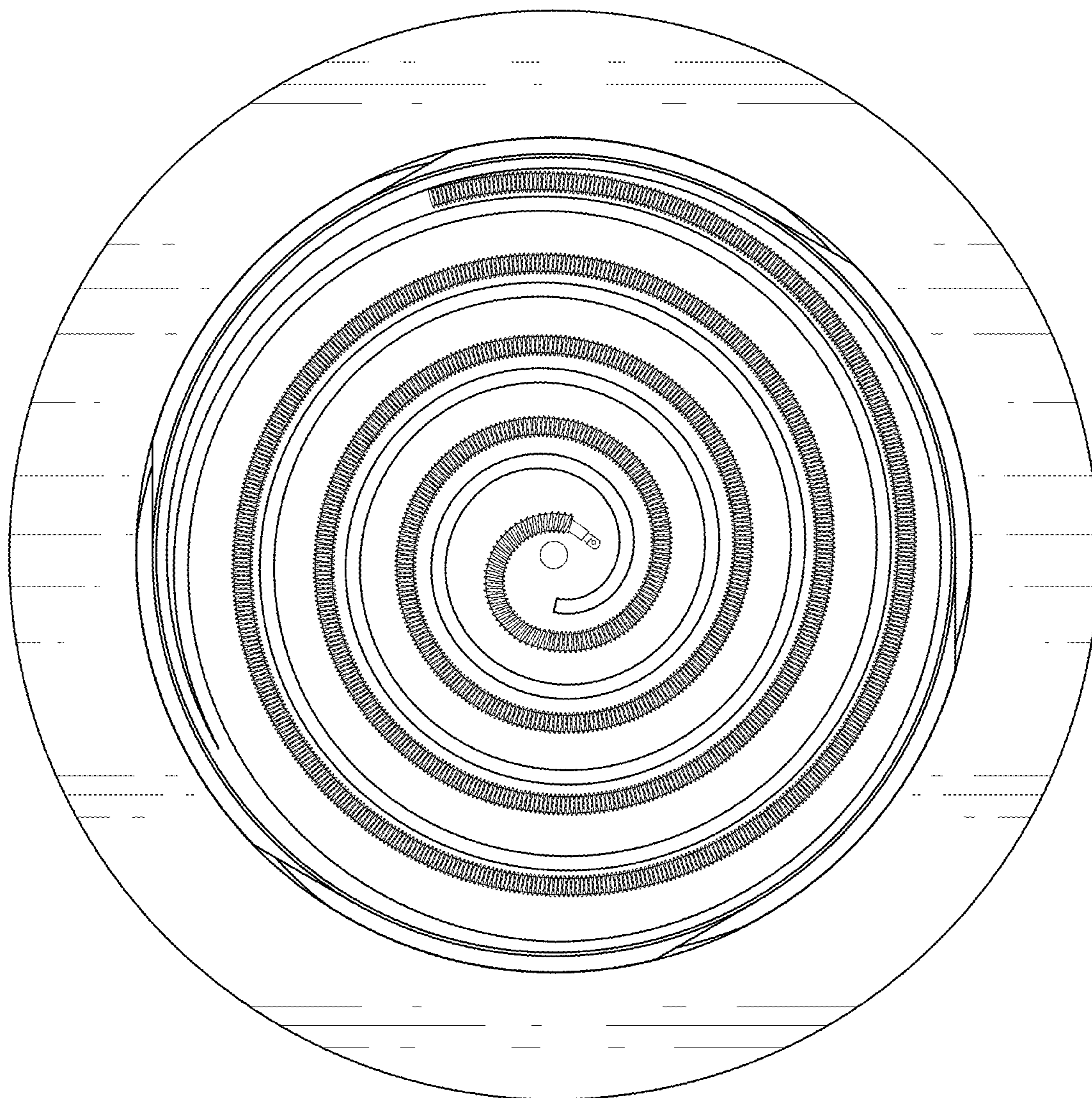

FIG. 10

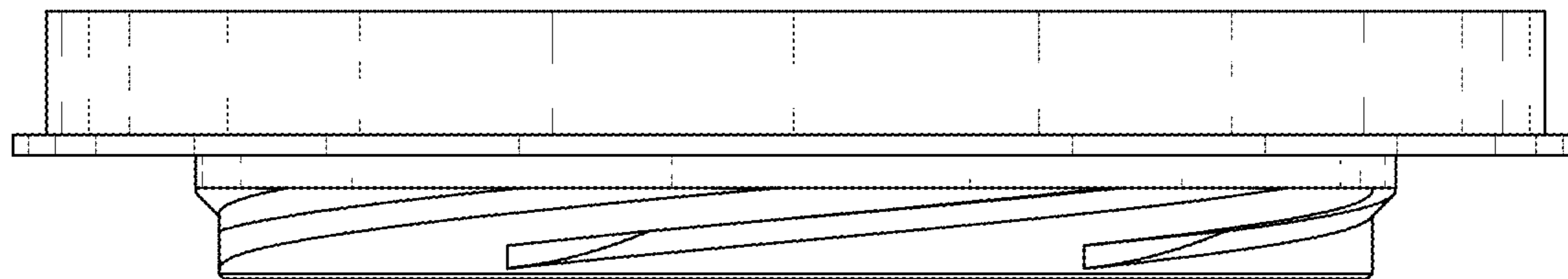

FIG. 11

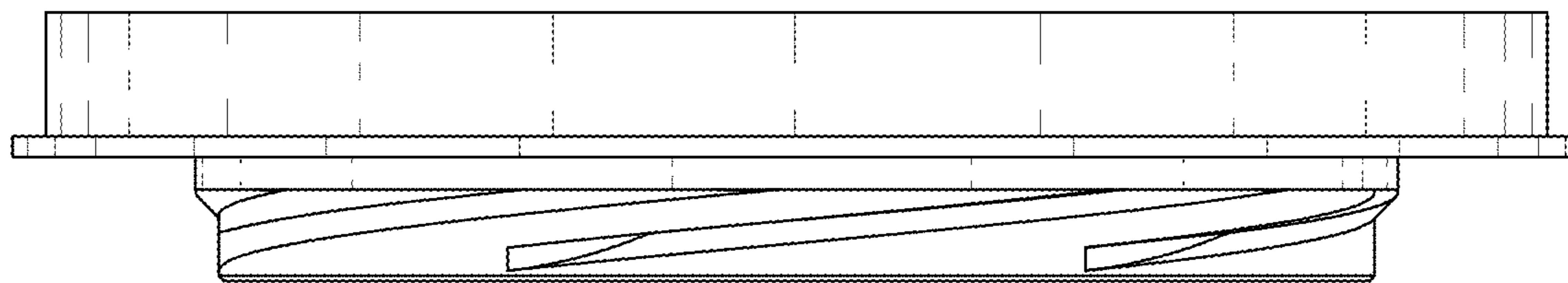

FIG. 12

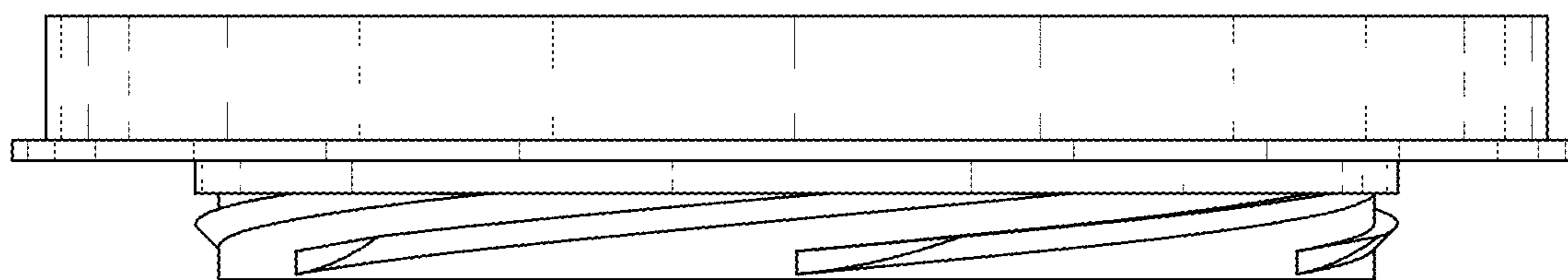

FIG. 13

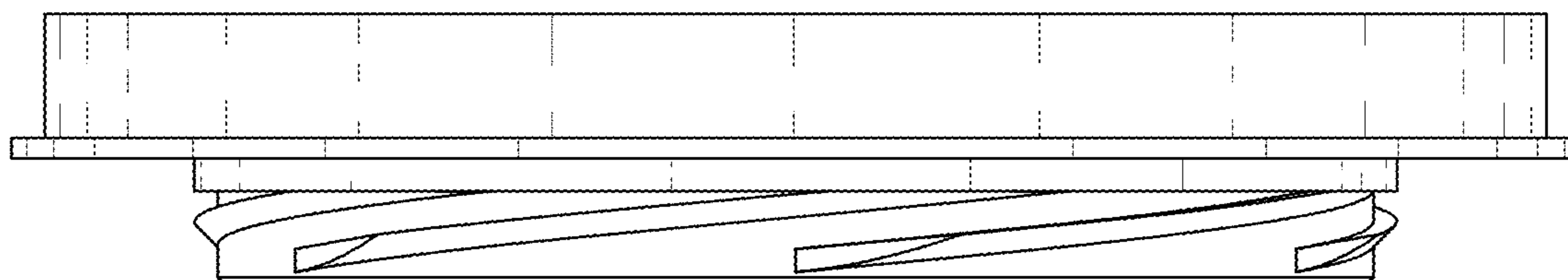

FIG. 14

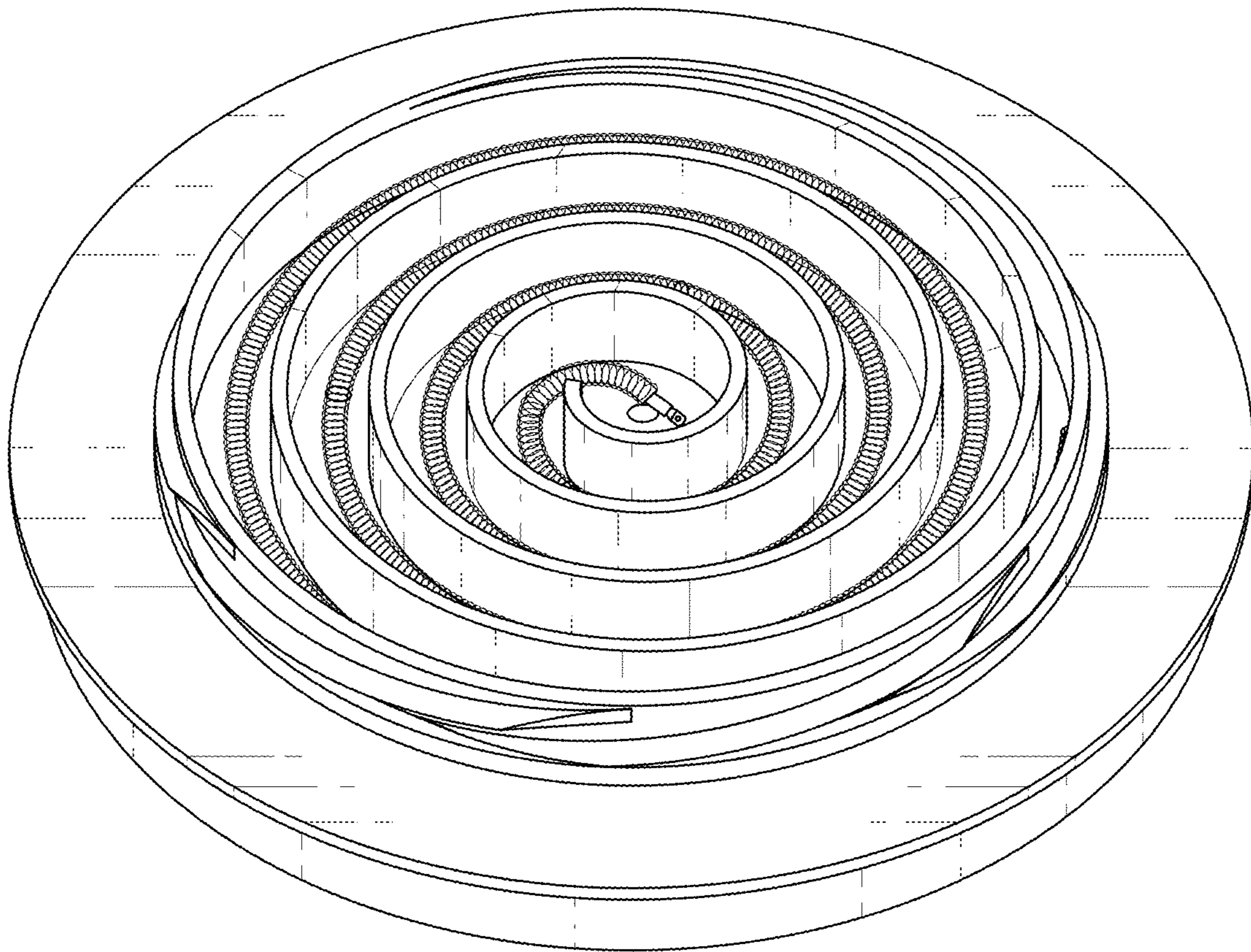

FIG. 15

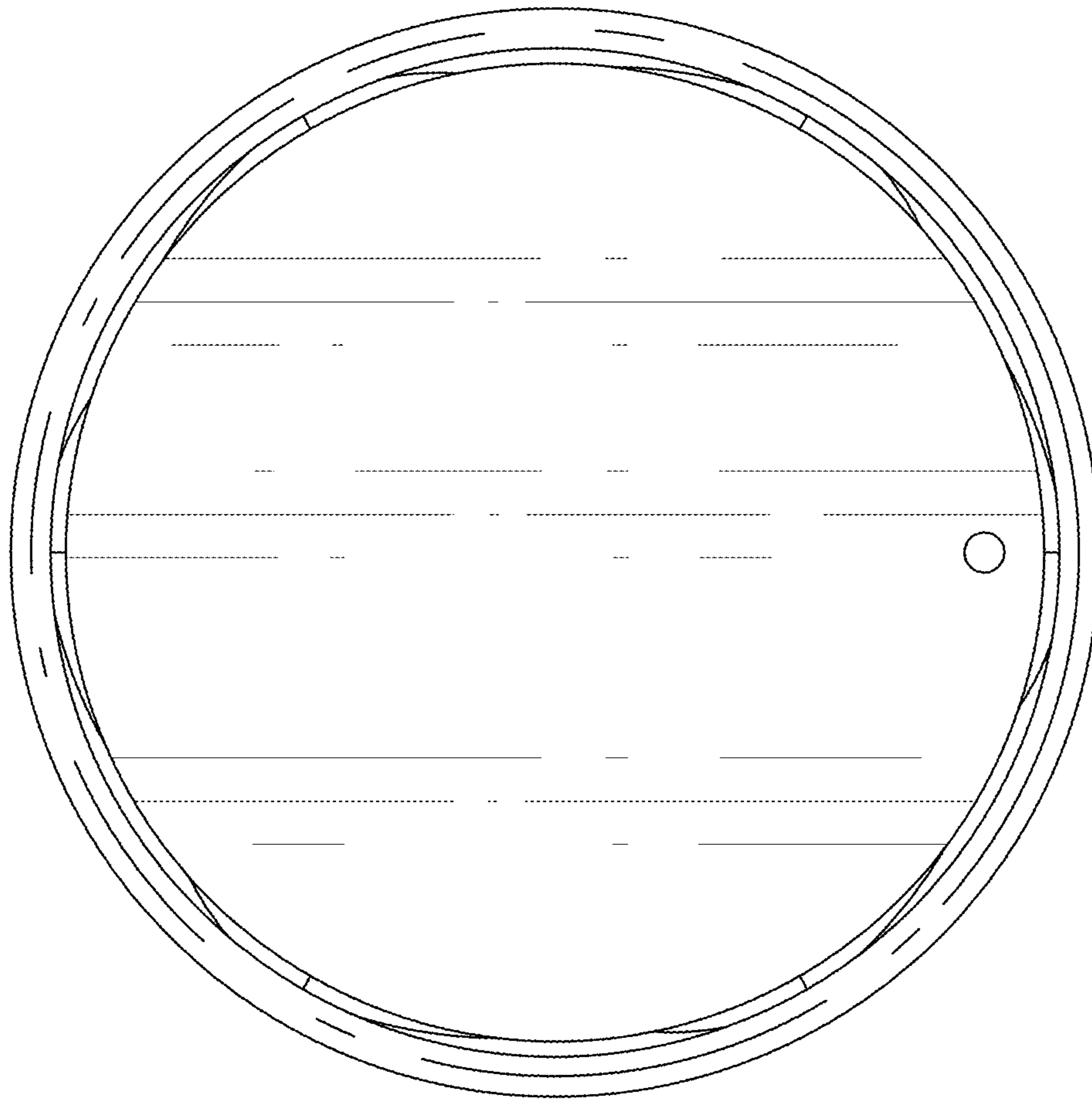

FIG. 16

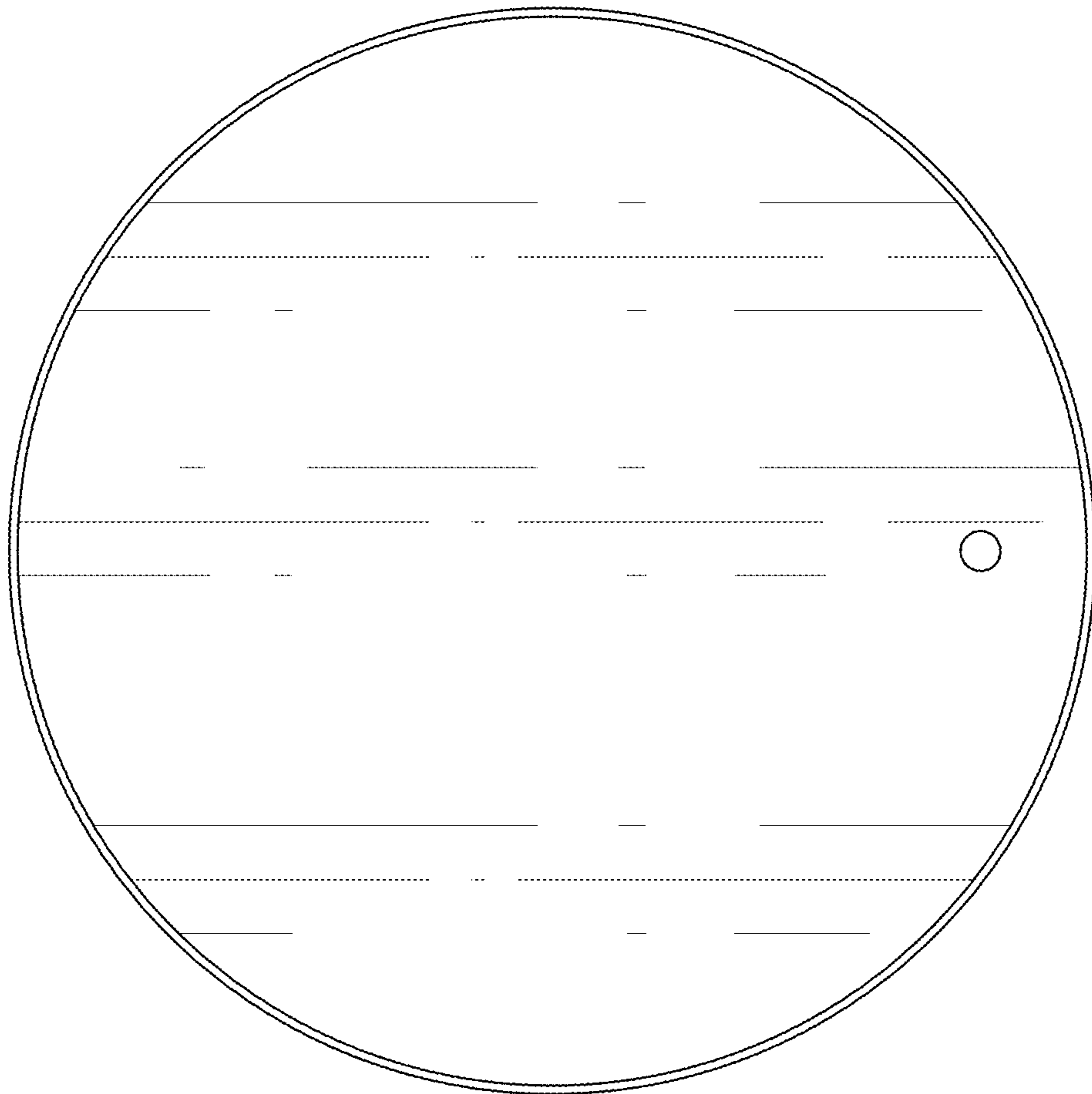

FIG. 17

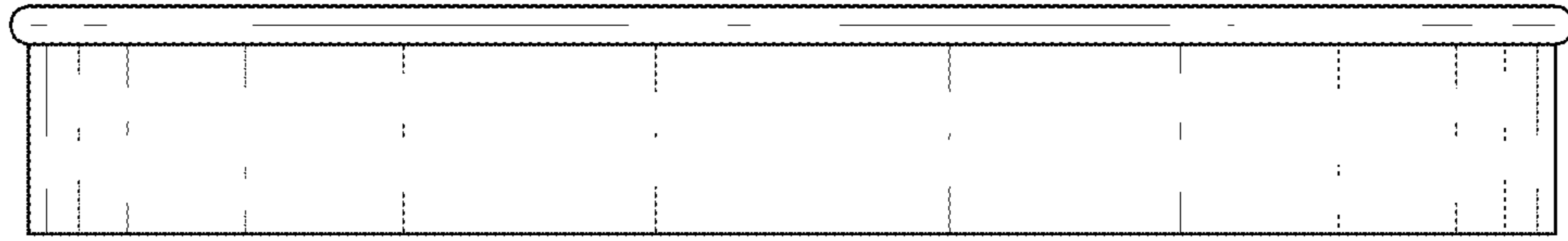

FIG. 18

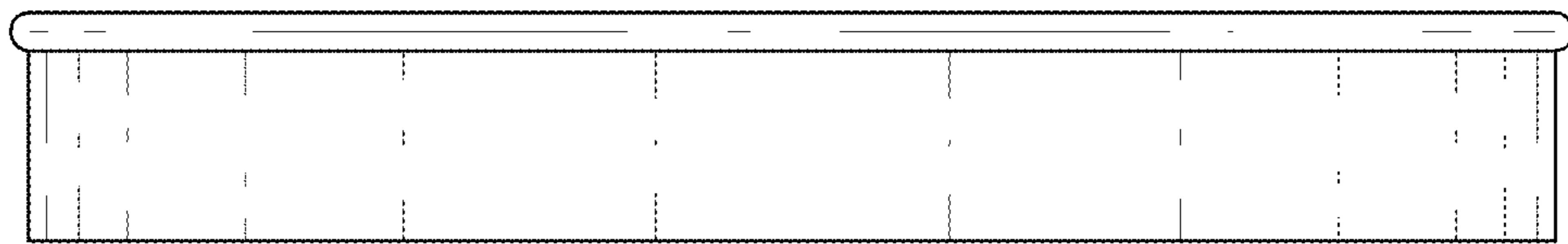

FIG. 19

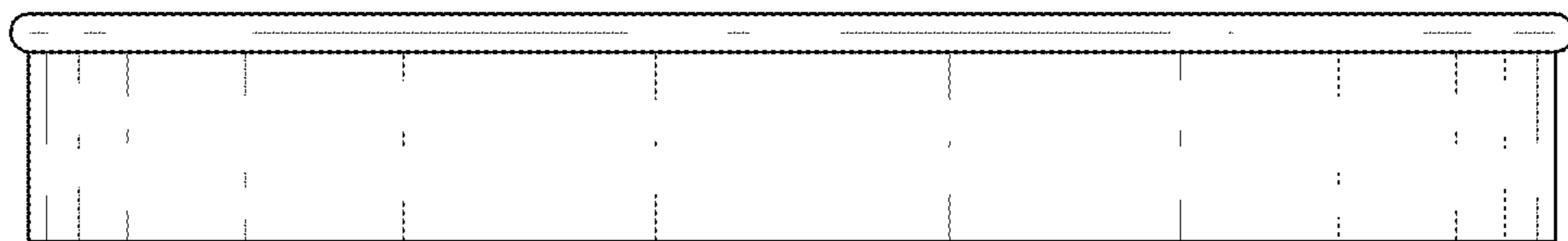

FIG. 20

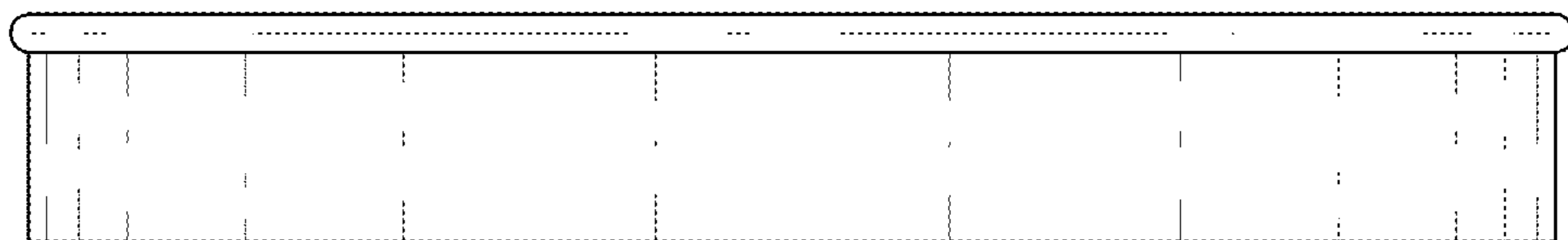

FIG. 21

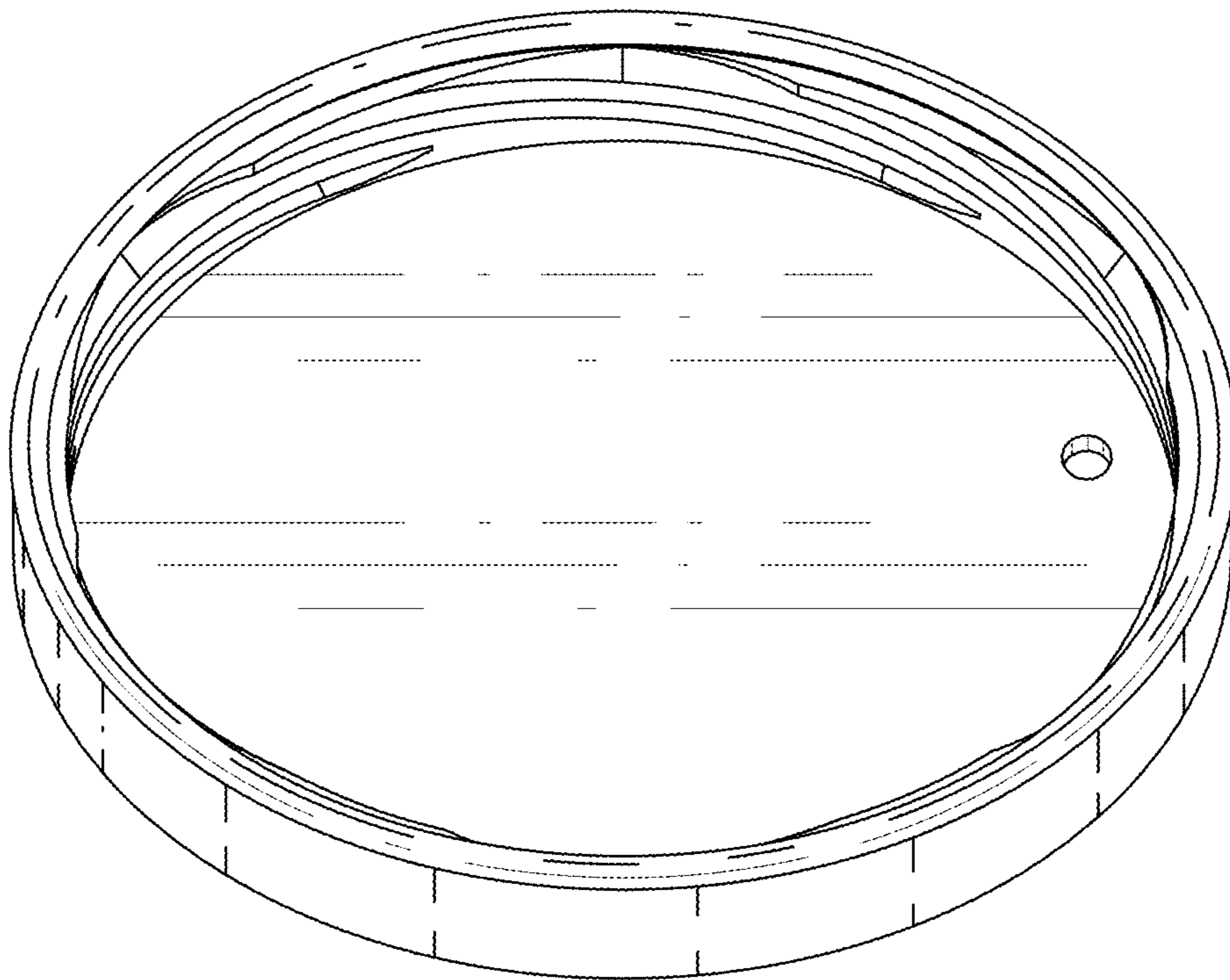

FIG. 22