



US00D887533S

(12) **United States Design Patent**
Alves Moreira

(10) **Patent No.:** **US D887,533 S**
(45) **Date of Patent:** **** Jun. 16, 2020**

- (54) **BATHTUB**
- (71) Applicant: **Metalúrgica Recor, S.A.**, Arrifana (PT)
- (72) Inventor: **Pedro Teófilo Alves Moreira**, Arrifana (PT)
- (73) Assignee: **Metalúrgica Recor, S.A.**, Arrifana (PT)
- (**) Term: **15 Years**
- (21) Appl. No.: **29/627,659**
- (22) Filed: **Nov. 29, 2017**

(30) **Foreign Application Priority Data**

Jul. 11, 2017 (EM) 004497816-0001

(51) **LOC (12) Cl.** **23-02**

(52) **U.S. Cl.**
USPC **D23/277**

(58) **Field of Classification Search**
USPC ... D23/277-279, 280.1, 280.2, 280.3, 280.4,
D23/304-307; D11/143-156;
D30/131-133
CPC A47K 3/006; A47K 3/02; A47K 3/022;
E05C 9/16
See application file for complete search history.

(56) **References Cited**

U.S. PATENT DOCUMENTS

- D101,637 S * 10/1936 Kohler D23/277
- D237,616 S * 11/1975 Gordon D23/277
- 8,651,065 B1 * 2/2014 Eash A01K 7/027
119/72
- D714,184 S * 9/2014 Lucht D11/155
- D714,427 S 9/2014 Oliveira
- D782,627 S 3/2017 Gomes de Oliveira

- D796,016 S * 8/2017 Urquiola Hidalgo D23/293.1
- D801,594 S * 10/2017 Hicks D30/131
- D823,158 S * 7/2018 Ryan D11/155
- D834,157 S * 11/2018 L'Henaff D23/277
- 2008/0257274 A1 * 10/2008 Drouillard A01K 7/00
119/72

OTHER PUBLICATIONS

Recor Allen Freestanding Bathtub [Jan. 24, 2019] found online [Jan. 24, 2019]—<http://www.recor.pt/gb/products/freestanding.bathtubs/allen>.*

* cited by examiner

Primary Examiner — Brandon M Rosati
Assistant Examiner — John A Voytek
(74) *Attorney, Agent, or Firm* — Quinn IP Law

(57) **CLAIM**

I claim the ornamental design for a bathtub, as shown and described.

DESCRIPTION

FIG. 1 is a top and left and front perspective view of a bathtub;
FIG. 2 is a front elevation view thereof;
FIG. 3 is a rear elevation view thereof;
FIG. 4 is a left side elevation view thereof;
FIG. 5 is right side elevation view thereof;
FIG. 6 is a top plan view thereof;
FIG. 7 is a bottom plan view thereof; and,
FIG. 8 is a top and right and rear perspective view thereof.
All broken lines illustrate portions of the bathtub to which the design is applied that form no part of the claim.

1 Claim, 8 Drawing Sheets

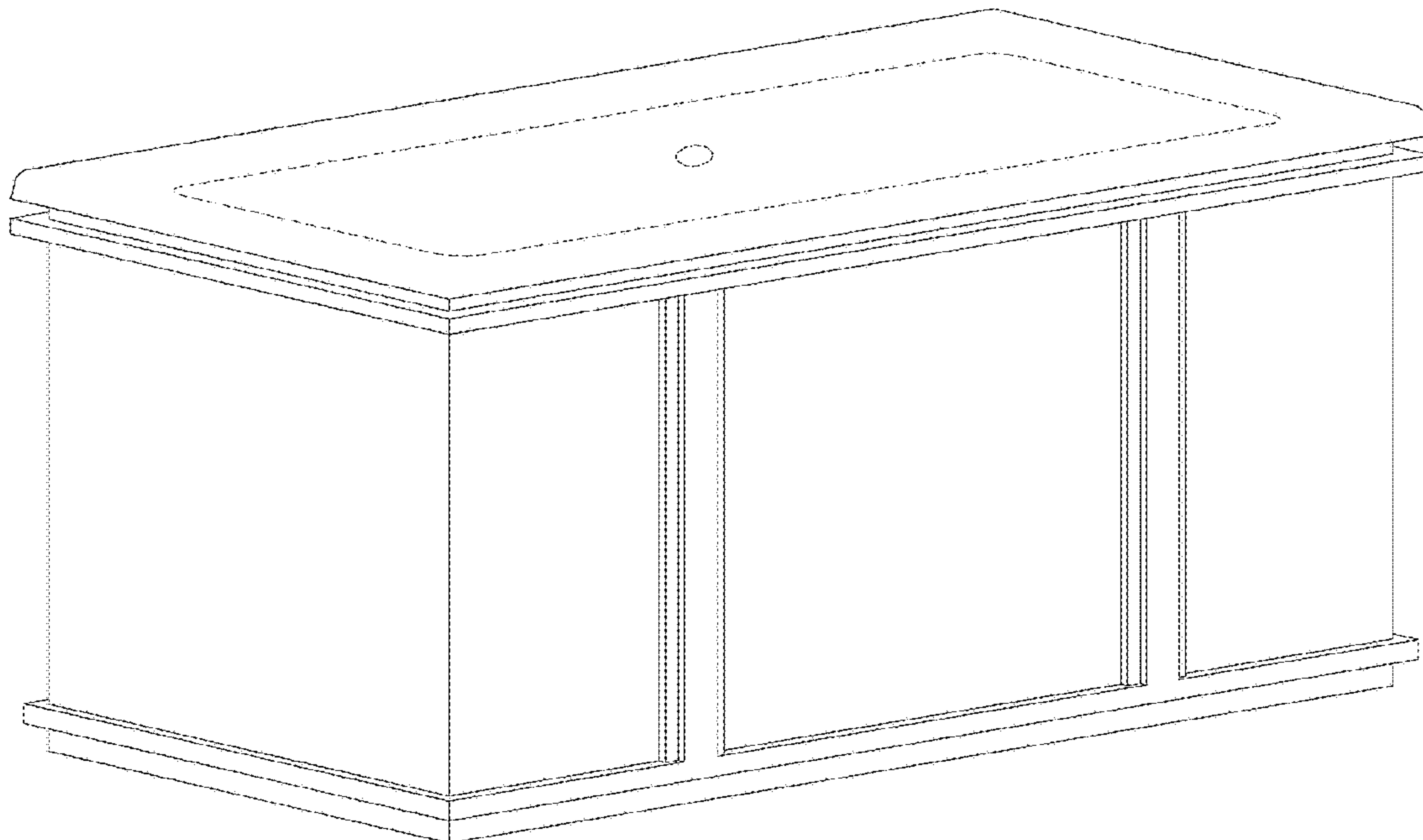

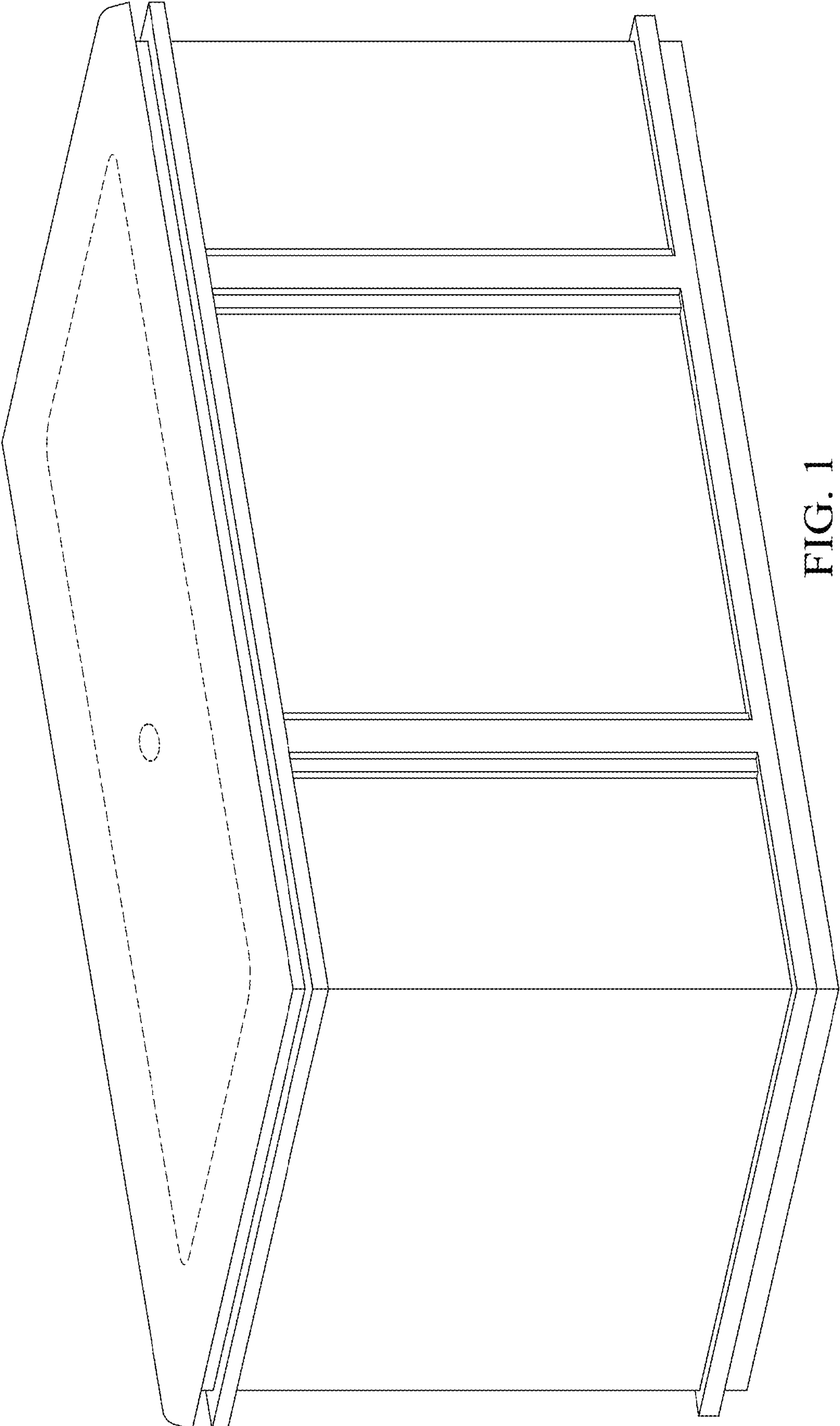

FIG. 1

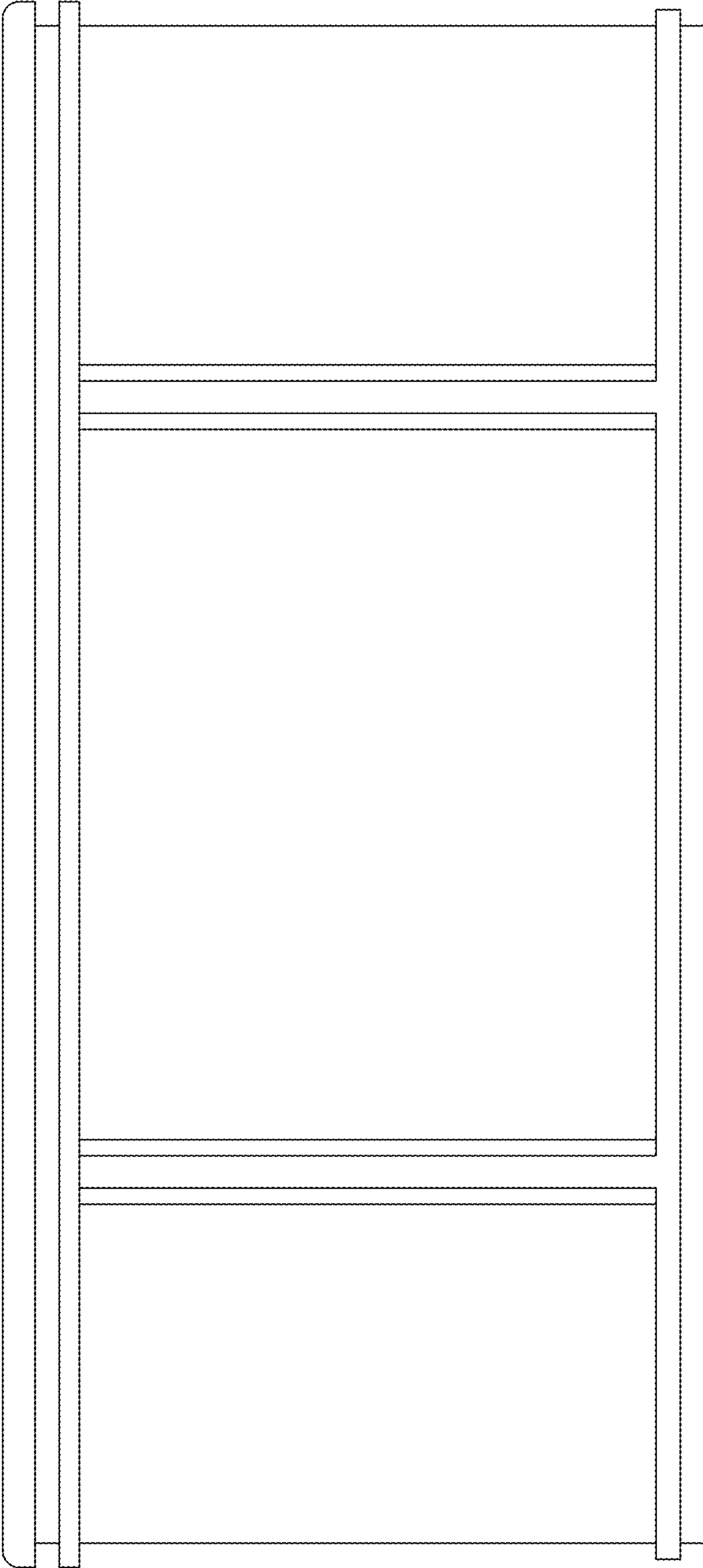

FIG. 2

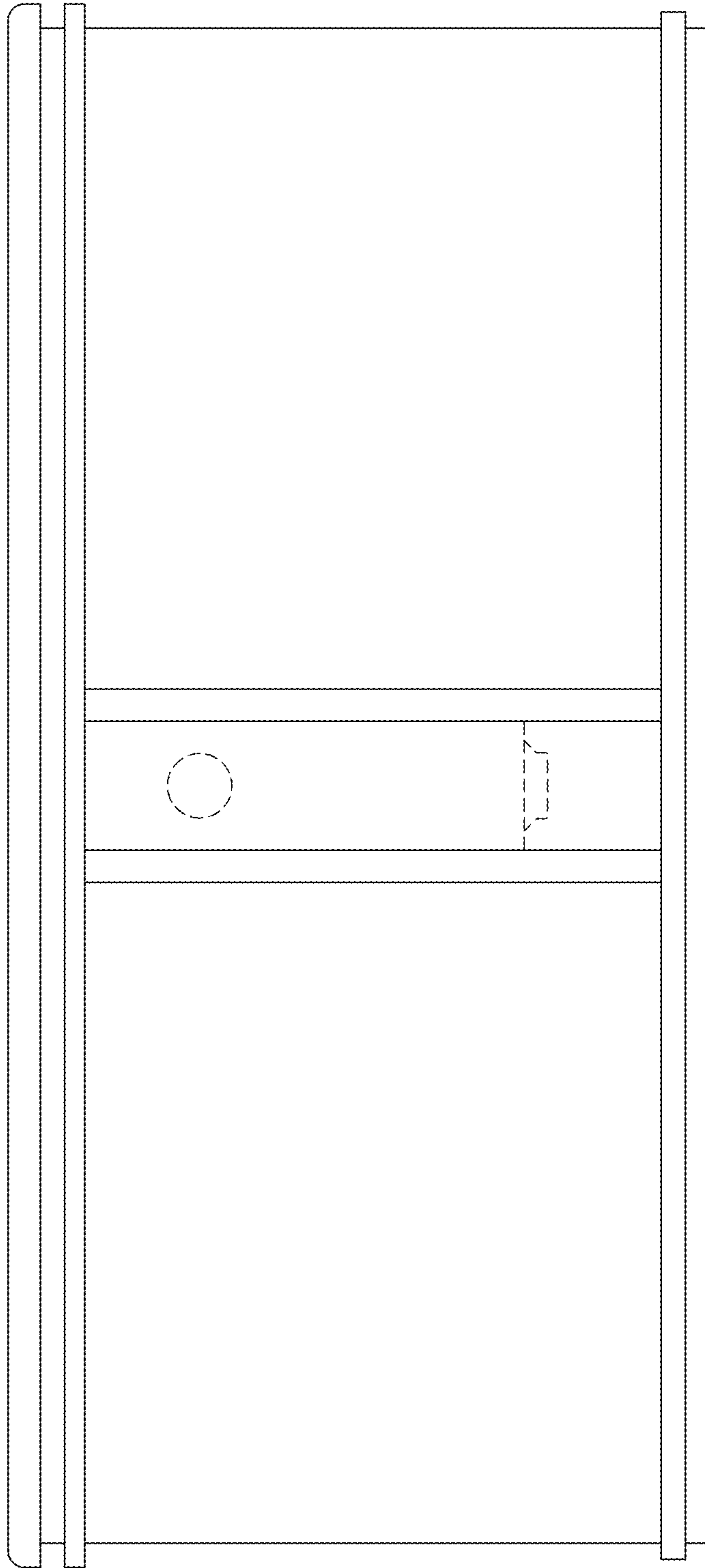

FIG. 3

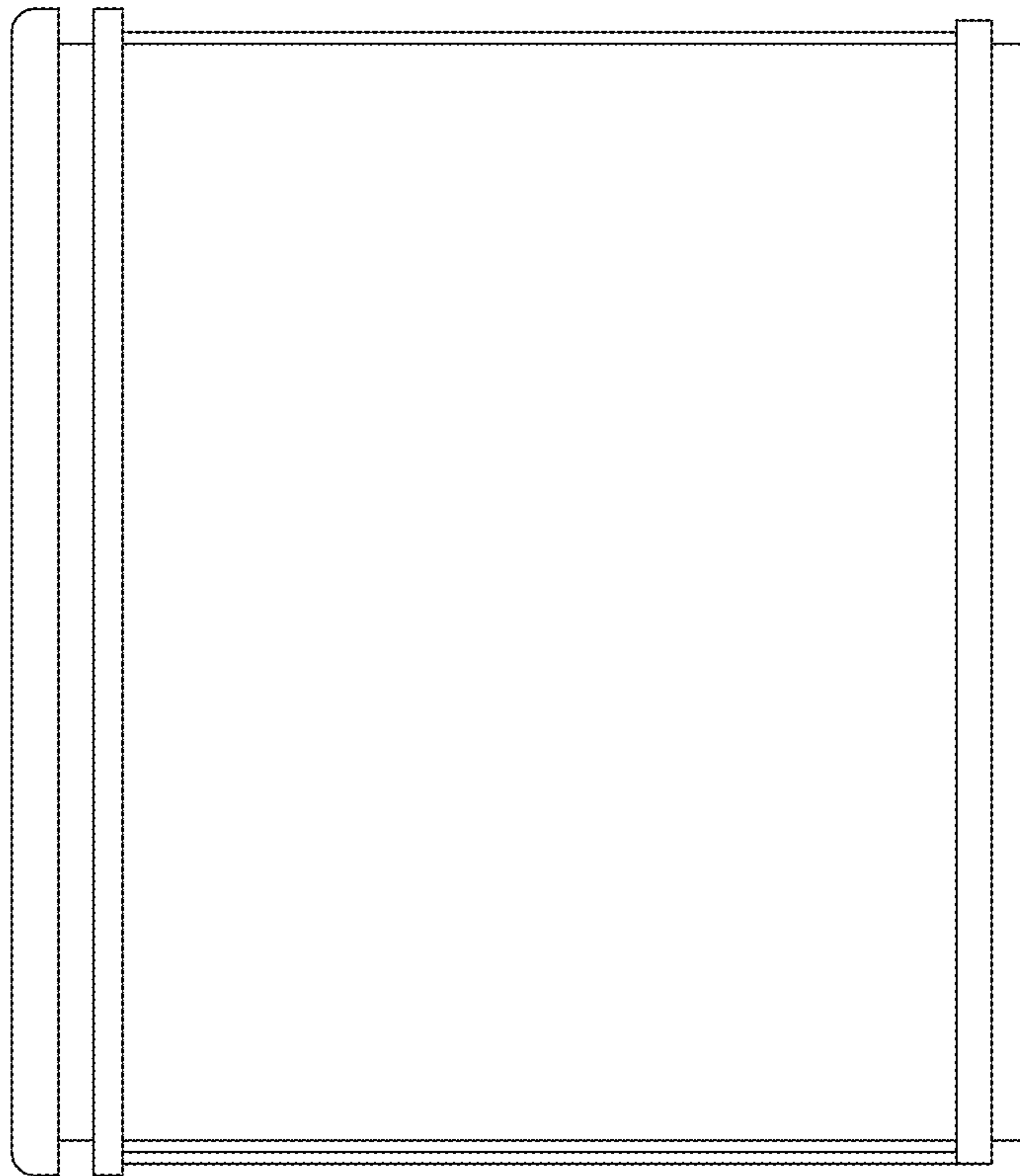

FIG. 4

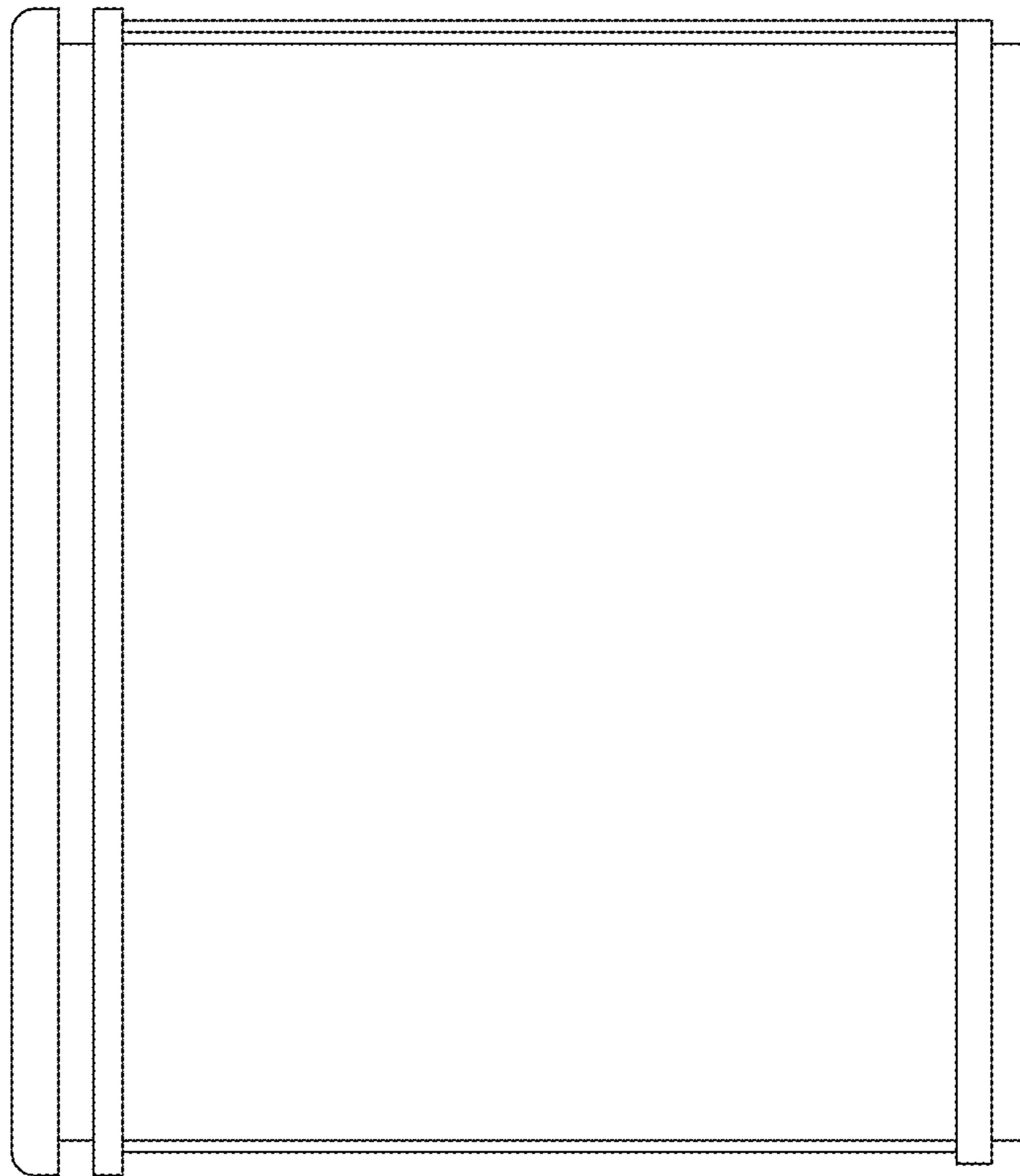

FIG. 5

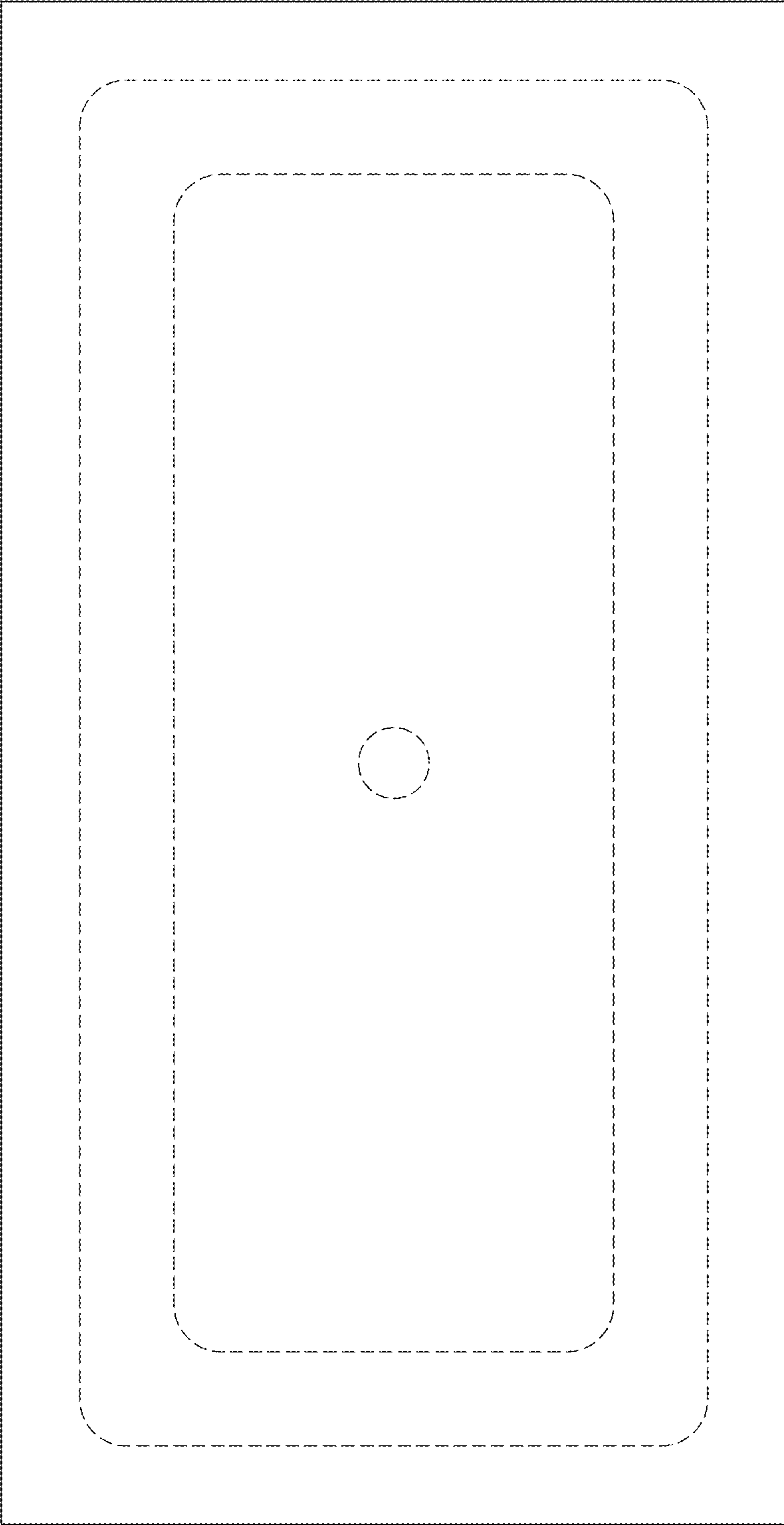

FIG. 6

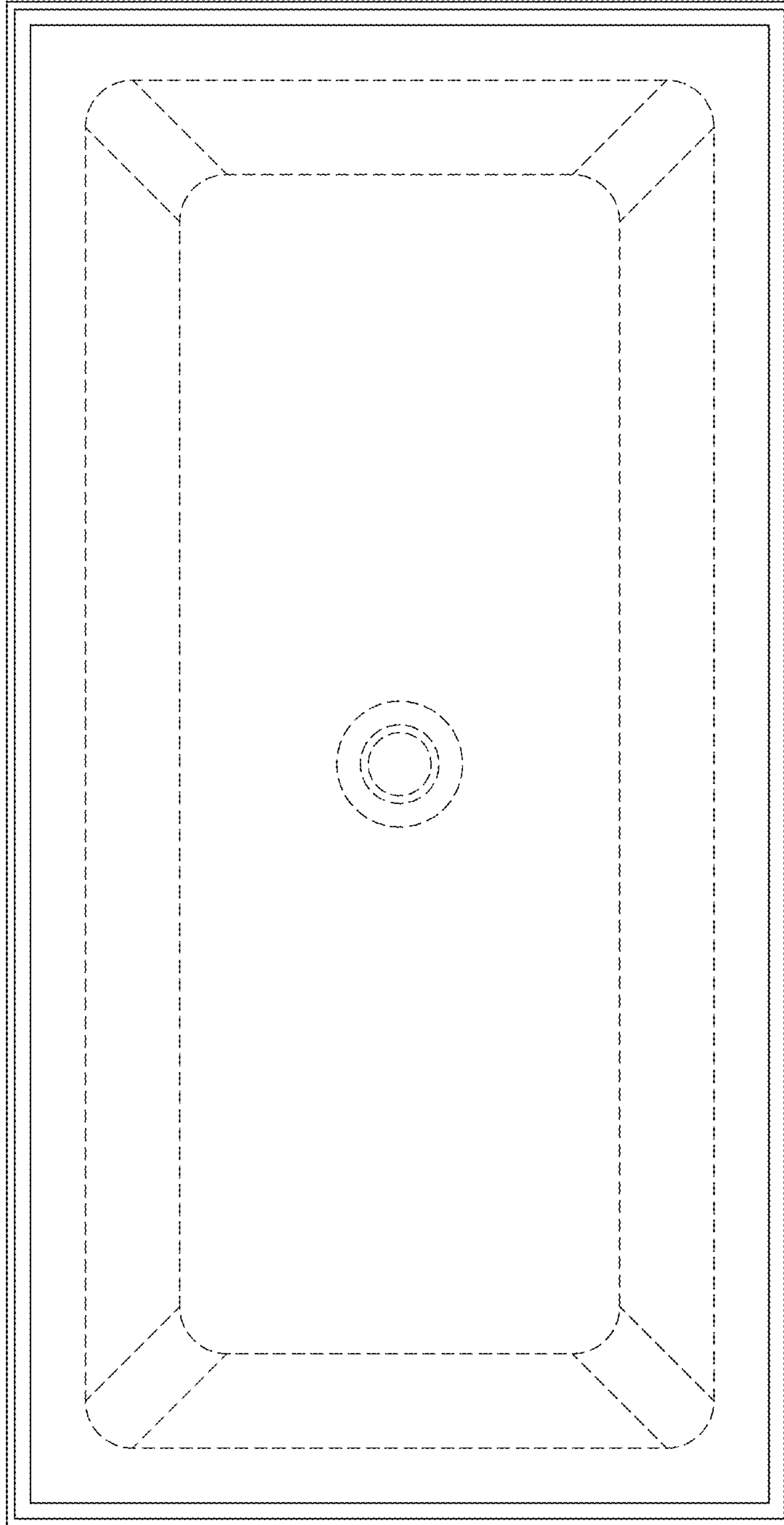

FIG. 7

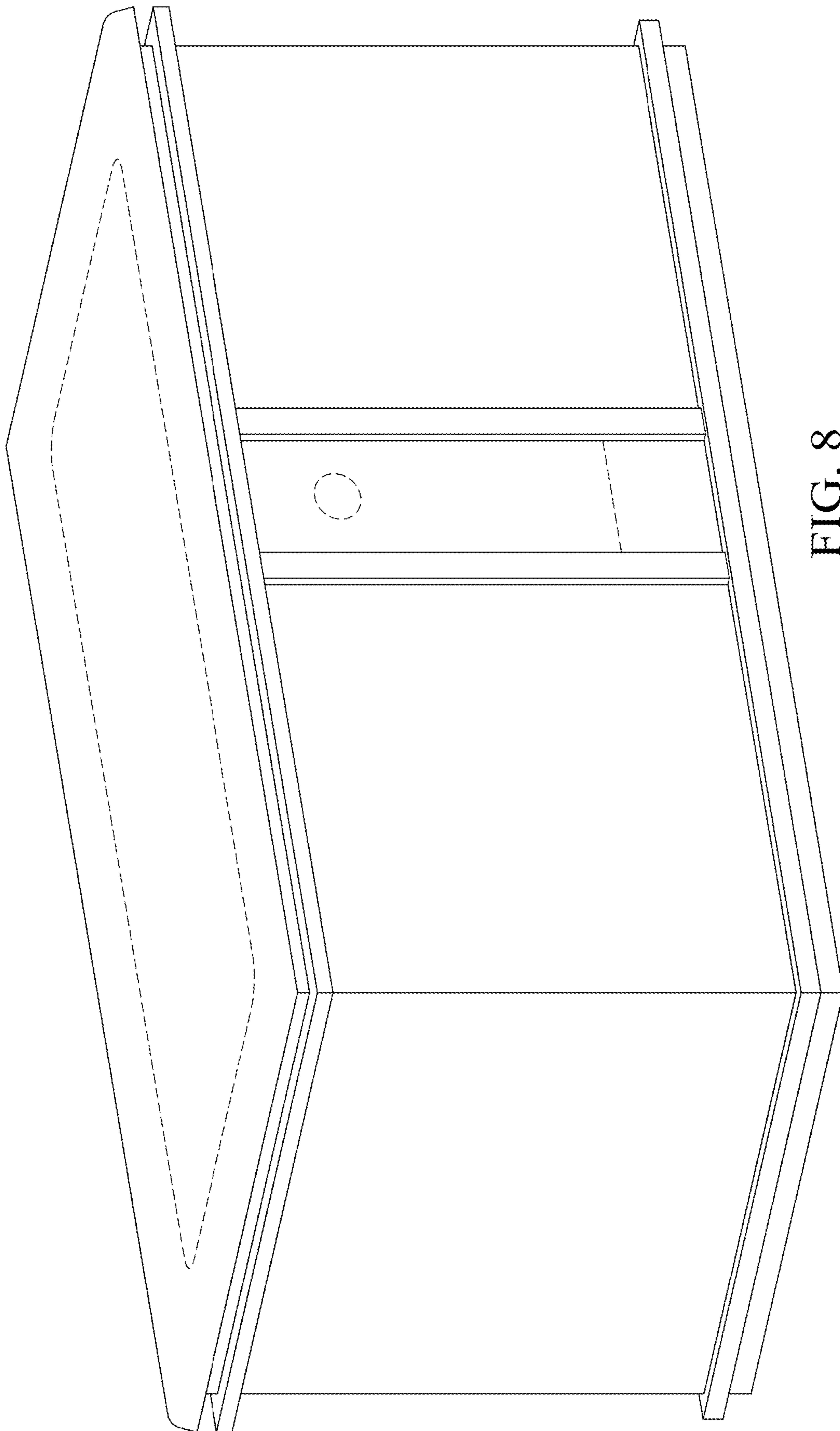

FIG. 8