



US00D887495S

(12) **United States Design Patent** (10) **Patent No.:** **US D887,495 S**
Bernard et al. (45) **Date of Patent:** **** Jun. 16, 2020**

(54) **GAMING MACHINE**

OTHER PUBLICATIONS

(71) Applicant: **BALLY GAMING, INC.**, Las Vegas, NV (US)

AU Optronics Corp.; News Center. "AUO Announces Multiple Upcoming Innovations"; Oct. 27, 2008; retrieved from <http://www.auo.com/?sn=107&lang=en-US&c=10&n=363> on Mar. 3, 2017 (2 pages).

(72) Inventors: **Vernon Bernard**, Las Vegas, NV (US); **Robert J. Glenn, II**, Chicago, IL (US); **Scott T. Hilbert**, Sparks, NV (US); **Christian Kulujian**, Chicago, IL (US); **Paul M. Lesley**, Chicago, IL (US); **Gordon Myers**, Reno, NV (US); **Karl Wudtke**, Henderson, NV (US)

(Continued)

Primary Examiner — Ryan Harvey
(74) *Attorney, Agent, or Firm* — Banner & Witcoff, Ltd.

(73) Assignee: **SG Gaming, Inc.**, Las Vegas, NV (US)

(57) **CLAIM**

The ornamental design for a gaming machine, as shown and described.

(**) Term: **15 Years**

DESCRIPTION

(21) Appl. No.: **29/657,655**

FIG. 1 is a front right top perspective view of a gaming machine showing our new design;

(22) Filed: **Jul. 24, 2018**

FIG. 2 is a top view thereof;

(51) **LOC (12) Cl.** **21-03**

FIG. 3 is a bottom perspective view thereof;

(52) **U.S. Cl.**

FIG. 4 is a front view thereof;

USPC **D21/369**

FIG. 5 is a right side view thereof;

(58) **Field of Classification Search**

USPC D21/369, 370, 371, 385, 329, 325, 394;
D14/307, 172, 129, 325, 401, 371, 126,

FIG. 6 is a rear view thereof;

(Continued)

FIG. 7 is a left side view thereof;

FIG. 8 is a bottom view thereof;

(56) **References Cited**

U.S. PATENT DOCUMENTS

2,661,954 A 12/1953 Koci
D236,720 S 9/1975 Baker

(Continued)

FIG. 9 is a cross-section view thereof taken through line 9-9 of FIG. 2;

FIG. 10 is a front perspective view of the gaming machine of FIGS. 1-9 with the stand shown in an alternate position;

FIG. 11 is a bottom perspective view thereof;

FIG. 12 is a front view thereof;

FIG. 13 is a right side view thereof;

FIG. 14 is a rear view thereof;

FIG. 15 is a left side view thereof;

FIG. 16 is a top view thereof; and,

FIG. 17 is a bottom view thereof.

The broken lines depicting the remainder of the gaming machine illustrates environmental structure and form no part of the claimed design. The curved oblique line shading shows that the surface is a transparent, translucent, highly polished or reflective surface.

FOREIGN PATENT DOCUMENTS

AU 201811904 4/2018
AU 201811905 4/2018

(Continued)

1 Claim, 17 Drawing Sheets

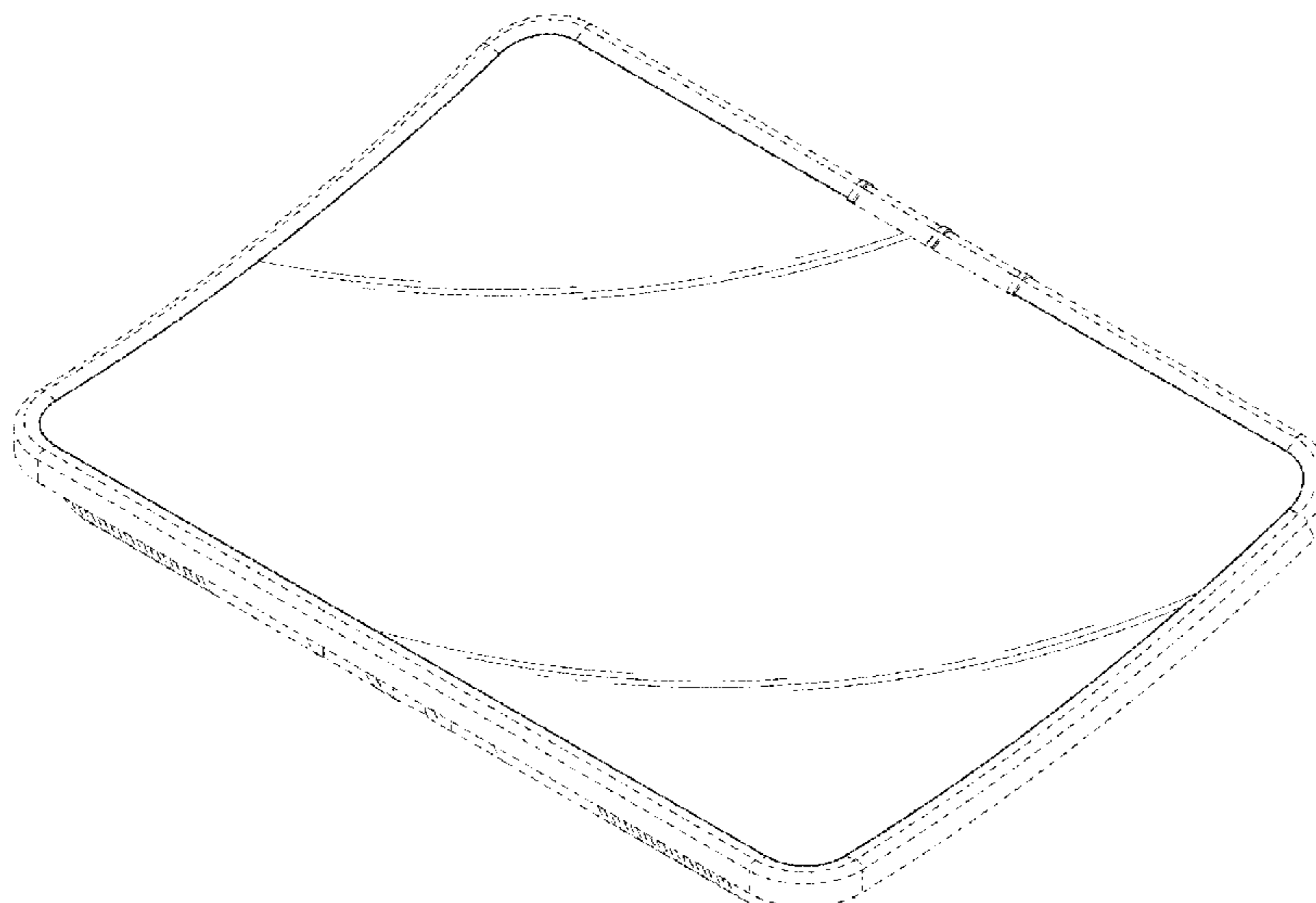

(58) **Field of Classification Search**
 USPC D14/439, 432, 450, 128, 375, 248, 374,
 D14/341, 138 G, 127; 463/28, 13, 11,
 463/16, 20, 25, 31, 46, 23, 30, 17, 36, 29,
 463/42, 34, 32, 35, 19, 21, 22; 273/292,
 273/203, 138.2, 143 R, 142 R, 138.1;
 D19/60; D16/226; D8/335, 331, 334;
 D26/141; D7/641
 CPC G07F 17/32; G07F 17/34; G07F 17/3211;
 G07F 17/3244; G07F 17/3267
 See application file for complete search history.

(56) **References Cited**

U.S. PATENT DOCUMENTS

D238,379 S 1/1976 Miller
 4,046,419 A 9/1977 Schmitt
 D264,485 S 5/1982 Kitchen
 4,372,557 A 2/1983 Del Principe et al.
 4,373,725 A 2/1983 Ritchie
 D275,772 S 10/1984 Akopian et al.
 D280,835 S 10/1985 Berge et al.
 D280,836 S 10/1985 Ludzia et al.
 4,606,545 A 8/1986 Ritchie
 4,614,342 A * 9/1986 Takashima A63F 13/12
 463/11
 4,705,274 A 11/1987 Lubeck
 4,840,343 A 6/1989 Gasser
 4,861,037 A 8/1989 Oursler
 4,930,117 A 5/1990 Huggins
 4,981,298 A 1/1991 Lawlor et al.
 D315,110 S 3/1991 Slater
 5,015,189 A 5/1991 Wenzinger
 D318,660 S 7/1991 Weber
 5,074,558 A 12/1991 Bleich et al.
 5,083,738 A 1/1992 Infanti
 5,091,677 A 2/1992 Bleich et al.
 5,102,192 A 4/1992 Barile, Sr.
 5,110,120 A 5/1992 Smolucha
 5,114,112 A 5/1992 Infanti
 5,120,058 A 6/1992 Trudeau et al.
 5,123,647 A 6/1992 Lawlor et al.
 5,143,055 A 9/1992 Eakin
 5,149,094 A 9/1992 Tastad
 D333,164 S 2/1993 Kraft et al.
 5,193,807 A 3/1993 Schilling et al.
 5,195,746 A 3/1993 Boyd et al.
 D335,150 S 4/1993 Biagi et al.
 5,226,653 A 7/1993 Bil et al.
 5,232,191 A 8/1993 Infanti
 5,290,034 A 3/1994 Hineman
 5,297,793 A 3/1994 DeMar et al.
 5,316,303 A 5/1994 Trudeau et al.
 5,322,283 A 6/1994 Ritchie et al.
 5,326,104 A 7/1994 Pease et al.
 5,350,174 A 9/1994 Ritchie et al.
 D351,869 S 10/1994 Rothschild et al.
 5,351,954 A 10/1994 Oursler et al.
 5,357,104 A 10/1994 Bleich
 5,358,241 A 10/1994 Anghelo et al.
 5,358,242 A 10/1994 Trudeau et al.
 5,358,243 A 10/1994 Eddy et al.
 D352,738 S 11/1994 Anghelo et al.
 5,383,663 A 1/1995 Anghelo et al.
 5,405,144 A 4/1995 Ritchie et al.
 5,409,296 A 4/1995 Barile
 D358,616 S * 5/1995 Chung-Po D21/325
 5,411,257 A 5/1995 Fulton
 5,415,402 A 5/1995 Morrison et al.
 5,415,403 A 5/1995 Ritchie et al.
 5,417,423 A 5/1995 Oursler et al.
 5,417,425 A 5/1995 Blumberg et al.
 5,437,453 A 8/1995 Hineman
 5,465,963 A 11/1995 Patla, Sr.
 5,472,197 A 12/1995 Gwiasda et al.
 5,494,286 A 2/1996 DeMar et al.

5,507,488 A 4/1996 Eddy et al.
 5,511,783 A 4/1996 Popadiuk et al.
 5,516,103 A 5/1996 Lawlor et al.
 5,522,641 A 6/1996 Infanti
 5,524,887 A 6/1996 Trudeau et al.
 5,533,726 A 7/1996 Nordman et al.
 5,542,748 A 8/1996 Barile
 D376,391 S 12/1996 Okumura
 5,580,052 A 12/1996 Popadiuk et al.
 5,632,482 A 5/1997 Anghelo
 D380,014 S 6/1997 Yang
 5,655,965 A 8/1997 Takemoto et al.
 5,664,777 A 9/1997 Nordman et al.
 5,669,818 A 9/1997 Thorner et al.
 5,678,886 A 10/1997 Infanti
 5,697,612 A 12/1997 Piotrowski et al.
 5,704,835 A 1/1998 Dietz, II
 5,707,059 A 1/1998 Sullivan et al.
 5,720,480 A 2/1998 Lawlor et al.
 D395,463 S 6/1998 Scott et al.
 5,762,617 A 6/1998 Infanti
 5,791,731 A 8/1998 Infanti
 5,806,851 A 9/1998 Gomez et al.
 5,820,460 A 10/1998 Fulton
 5,833,236 A 11/1998 Oursler et al.
 D405,473 S 2/1999 Tikhonski et al.
 D407,759 S 4/1999 Isetani et al.
 D408,366 S 4/1999 Popadiuk
 5,890,715 A 4/1999 Gomez et al.
 5,899,454 A 5/1999 Eddy et al.
 5,924,690 A 7/1999 Kopera et al.
 5,934,672 A 8/1999 Sines et al.
 5,938,195 A 8/1999 Anghelo et al.
 5,944,309 A 8/1999 Popadiuk et al.
 D415,211 S * 10/1999 Yamaguchi D21/327
 D417,145 S 11/1999 McLaughlin
 5,984,782 A 11/1999 Inoue
 6,000,697 A 12/1999 Popadiuk et al.
 D419,201 S 1/2000 de Haas
 D419,606 S 1/2000 Toriyama
 6,036,188 A 3/2000 Gomez et al.
 6,047,962 A 4/2000 Popadiuk
 6,047,963 A 4/2000 Pierce et al.
 D424,122 S 5/2000 Dickenson et al.
 6,071,190 A 6/2000 Weiss et al.
 D428,062 S 7/2000 Hayashi
 6,089,663 A 7/2000 Hill
 D429,769 S * 8/2000 Luciano D21/333
 6,102,394 A 8/2000 Wurz et al.
 6,113,097 A 9/2000 Krutsch et al.
 6,117,010 A 9/2000 Canterbury et al.
 6,120,021 A 9/2000 Piotrowski et al.
 6,129,353 A 10/2000 DeMar et al.
 6,129,355 A 10/2000 Hahn et al.
 6,135,449 A 10/2000 Cornell et al.
 6,135,562 A 10/2000 Infanti
 6,149,153 A 11/2000 Sheats, Jr.
 D435,270 S * 12/2000 Healy D20/10
 6,155,565 A 12/2000 Gomez et al.
 6,155,925 A 12/2000 Giobbi et al.
 6,158,737 A 12/2000 Cornell et al.
 6,159,098 A 12/2000 Slomiany et al.
 6,164,644 A 12/2000 Cornell et al.
 6,173,955 B1 1/2001 Perrie et al.
 6,199,861 B1 3/2001 Hume et al.
 D439,931 S 4/2001 Yamaguchi
 6,210,279 B1 4/2001 Dickinson
 6,224,482 B1 5/2001 Bennett
 6,227,614 B1 5/2001 Rubin
 6,227,970 B1 5/2001 Shimizu et al.
 D443,313 S 6/2001 Brettschneider
 D446,252 S 8/2001 Yamaguchi
 6,283,546 B1 9/2001 Hill
 6,290,229 B1 9/2001 Perez
 D450,094 S 11/2001 Hedrick et al.
 6,334,612 B1 1/2002 Wurz et al.
 6,354,660 B1 3/2002 Friedrich
 D459,402 S 6/2002 Wurz et al.
 D460,915 S * 7/2002 Lynch D21/329

(56)

References Cited

U.S. PATENT DOCUMENTS

6,422,670 B1	7/2002	Hedrick et al.	D566,196 S *	4/2008	Morrow	D21/329
6,422,941 B1	7/2002	Thorner et al.	D566,197 S	4/2008	Greenberg et al.	
6,439,993 B1	8/2002	O'Halloran	D569,863 S	5/2008	Feldstein et al.	
D463,504 S	9/2002	Stephan	D569,919 S *	5/2008	Zielinski	D21/370
6,443,837 B1 *	9/2002	Jaffe	D572,314 S	7/2008	Vallejo et al.	
	 G07F 17/32	D578,168 S	10/2008	Looks et al.	
		463/16	D579,500 S *	10/2008	Luciano, Jr.	D21/369
D464,377 S	10/2002	Wurz et al.	D581,983 S	12/2008	Bergstrom	
D465,813 S	11/2002	Randall	RE40,625 E	1/2009	Wurz et al.	
D466,160 S	11/2002	Hirato et al.	7,479,066 B2	1/2009	Emori	
D467,977 S	12/2002	Gatto et al.	D587,272 S	2/2009	Morrow et al.	
D468,364 S	1/2003	Beadell et al.	D587,319 S	2/2009	Moises Deiab	
6,530,842 B1	3/2003	Wells et al.	RE40,671 E	3/2009	Wurz et al.	
6,530,872 B2	3/2003	Frehland et al.	7,503,849 B2	3/2009	Hornik et al.	
6,572,187 B2	6/2003	Laufer	D590,025 S	4/2009	Fiore	
6,589,114 B2	7/2003	Rose	D591,800 S *	5/2009	Hsu	D21/369
6,609,972 B2	8/2003	Seelig et al.	D592,708 S *	5/2009	Hsu	D21/369
6,616,142 B2	9/2003	Adams	D594,068 S	6/2009	Hsu	
6,620,047 B1	9/2003	Alcorn et al.	D596,090 S *	7/2009	Tufte	D12/168
D481,078 S	10/2003	Stephan	D596,678 S	7/2009	Myers	
6,646,695 B1	11/2003	Gauselmann	D599,365 S	9/2009	Brown et al.	
6,652,378 B2	11/2003	Cannon et al.	D599,858 S	9/2009	Lesley et al.	
D483,075 S	12/2003	Kang	D599,859 S	9/2009	Lesley et al.	
D484,548 S	12/2003	Franco Munoz et al.	D599,860 S	9/2009	Lesley et al.	
D485,583 S	1/2004	Porto	D601,637 S	10/2009	Myers et al.	
6,715,756 B2	4/2004	Inoue	D601,638 S	10/2009	Palmisano	
6,729,618 B1	5/2004	Koenig et al.	D604,368 S	11/2009	Lesley et al.	
D492,363 S	6/2004	Seelig et al.	7,628,693 B2	12/2009	Thomas	
D492,364 S	6/2004	Seelig et al.	7,666,085 B2	2/2010	Vorias et al.	
D492,365 S	6/2004	Munoz et al.	7,686,689 B2	3/2010	Thomas	
D492,676 S	7/2004	Monson et al.	D613,802 S	4/2010	Meyers et al.	
D493,843 S	8/2004	Jackson, Sr. et al.	7,690,976 B2	4/2010	Edidin et al.	
D493,846 S	8/2004	Seelig et al.	D615,598 S	5/2010	McComb et al.	
D495,754 S	9/2004	Wurz et al.	7,713,119 B2	5/2010	Pacey et al.	
D495,755 S	9/2004	Wurz et al.	D622,780 S	8/2010	Lesley et al.	
D498,267 S	11/2004	Crouch	D622,781 S	8/2010	Lesley et al.	
D500,098 S	12/2004	Doi	D622,782 S	8/2010	Chudek et al.	
6,880,825 B2	4/2005	Seelig et al.	D624,604 S	9/2010	Wudtke	
D505,162 S	5/2005	Bristol et al.	D625,368 S	10/2010	Nelson et al.	
D508,268 S	8/2005	Hanchar et al.	D626,182 S	10/2010	Cole et al.	
D508,269 S	8/2005	Wichinsky	D626,183 S	10/2010	Cole et al.	
D508,719 S	8/2005	de Haas	7,811,167 B2	10/2010	Giobbi et al.	
D508,961 S	8/2005	Gatto et al.	D631,060 S	1/2011	Flik et al.	
D509,254 S	9/2005	Rasmussen et al.	D631,100 S	1/2011	Palmisano	
D509,255 S	9/2005	Bristol et al.	D633,950 S	3/2011	Terpstra et al.	
D512,105 S	11/2005	Chitrapongse et al.	D637,238 S	5/2011	O'Keene et al.	
D513,511 S	1/2006	Decombe	D637,652 S	5/2011	Tahara et al.	
D515,144 S	2/2006	Boyd	7,938,728 B2	5/2011	Vetter et al.	
6,997,810 B2	2/2006	Cole	7,955,176 B2	6/2011	Tastad et al.	
D520,504 S	5/2006	Martin	D641,047 S	7/2011	Tahara et al.	
7,063,615 B2	6/2006	Alcorn et al.	7,976,393 B2	7/2011	Haga et al.	
7,108,237 B2	9/2006	Gauselmann	7,985,139 B2	7/2011	Lind et al.	
D531,677 S	11/2006	Mallory et al.	8,002,424 B2	8/2011	Hwang et al.	
7,184,277 B2	2/2007	Beirne	8,002,626 B2	8/2011	Englman	
D537,885 S	3/2007	Gadda et al.	D646,336 S	10/2011	Kelly et al.	
D539,854 S	4/2007	Luciano et al.	D646,337 S	10/2011	Kelly et al.	
D540,398 S	4/2007	Gadda et al.	D646,691 S	10/2011	Thai et al.	
D546,893 S	7/2007	Yamashita	D649,605 S	11/2011	Terpstra et al.	
7,247,098 B1	7/2007	Bradford et al.	8,070,610 B2	12/2011	Vetter et al.	
D548,801 S	8/2007	Groswirt	D651,608 S	1/2012	Allen et al.	
D548,802 S *	8/2007	Damjan	8,113,933 B2	2/2012	Thomas	
D549,785 S	8/2007	Luciano, Jr. et al.	8,137,192 B2	3/2012	Thomas	
7,267,612 B2	9/2007	Alcorn et al.	8,152,623 B2	4/2012	Fiden	
D554,710 S	11/2007	Malone et al.	8,162,740 B2	4/2012	Aoki	
D556,765 S	12/2007	Evans et al.	8,216,061 B2	7/2012	Pacey	
D557,748 S	12/2007	Jumper	8,226,459 B2	7/2012	Barrett et al.	
D558,276 S *	12/2007	Damjan	8,267,764 B1	9/2012	Aoki et al.	
7,311,597 B2	12/2007	Thomas	8,272,952 B2	9/2012	Manning et al.	
D559,328 S	1/2008	Rasmussen et al.	D669,076 S	10/2012	Haller	
D559,917 S	1/2008	Cole	8,292,451 B2	10/2012	Hwang et al.	
D560,724 S	1/2008	Johnson	8,303,420 B2	11/2012	Chudek et al.	
D560,725 S	1/2008	Johnson	8,305,743 B2	11/2012	Wu et al.	
D563,326 S	3/2008	Patel et al.	8,323,114 B2	12/2012	Burak et al.	
D563,481 S	3/2008	Looks et al.	D673,620 S	1/2013	Johnson et al.	
D564,600 S	3/2008	Greenberg et al.	D673,622 S	1/2013	Wudtke	
D564,601 S	3/2008	Strahinic et al.	8,353,755 B2	1/2013	Vann et al.	
			8,371,920 B2	2/2013	Gomez et al.	
			8,371,927 B2	2/2013	Englman	
			8,371,928 B2	2/2013	Englman et al.	

(56)

References Cited

U.S. PATENT DOCUMENTS

8,376,832 B2 2/2013 O'Connor et al.
 8,376,842 B2 2/2013 Rasmussen et al.
 D678,270 S * 3/2013 Song D14/341
 D678,955 S 3/2013 Lesley et al.
 D678,956 S 3/2013 Lesley et al.
 D678,957 S 3/2013 Cesaroni et al.
 D678,958 S 3/2013 Cesaroni et al.
 D681,130 S 4/2013 Lesley et al.
 8,430,756 B2 4/2013 McComb et al.
 D682,948 S 5/2013 Cesaroni et al.
 D685,033 S 6/2013 Wudtke
 D691,665 S 10/2013 Chudek
 D691,666 S 10/2013 Lesley et al.
 8,556,706 B2 10/2013 Barney et al.
 D693,343 S 11/2013 Haller
 D697,558 S 1/2014 Myers et al.
 D704,273 S 5/2014 Chudek
 D704,275 S 5/2014 Lesley et al.
 8,721,419 B2 5/2014 Aoki et al.
 D706,359 S 6/2014 Wudtke
 D706,741 S 6/2014 Myers
 D706,864 S * 6/2014 Branck D18/4.6
 D707,288 S * 6/2014 Branck D18/4.6
 D707,646 S * 6/2014 Kim D14/138 G
 D707,685 S * 6/2014 Johnson D14/447
 8,808,077 B1 * 8/2014 Chun G07F 17/3293
 463/11
 D712,975 S 9/2014 Lesley et al.
 D713,447 S * 9/2014 Balar D18/4.6
 D714,269 S * 9/2014 Lee D14/248
 D714,270 S * 9/2014 Lee D14/248
 D714,271 S * 9/2014 Lee D14/248
 D714,392 S * 9/2014 Arabian D21/369
 D714,875 S 10/2014 Wudtke et al.
 D715,279 S * 10/2014 Lee D14/248
 D715,364 S 10/2014 Wudtke et al.
 D719,615 S * 12/2014 Inoue D21/370
 D719,616 S * 12/2014 Inoue D21/370
 8,982,545 B2 3/2015 Kim et al.
 8,986,092 B2 3/2015 Thomas et al.
 D729,321 S * 5/2015 Arabian D21/369
 D730,993 S 6/2015 Castro et al.
 D733,088 S * 6/2015 Garneau D14/172
 9,058,717 B2 6/2015 Aoki et al.
 D736,751 S * 8/2015 Lee D14/248
 D736,752 S * 8/2015 Lee D14/248
 D740,888 S 10/2015 DePalma et al.
 D742,974 S 11/2015 Lesley et al.
 D742,975 S 11/2015 Myers et al.
 9,183,697 B2 * 11/2015 Kido G07F 17/3211
 D746,292 S * 12/2015 Heckler D14/447
 D746,380 S * 12/2015 van Linden D21/369
 D747,763 S * 1/2016 Haller D18/4.5
 9,269,233 B2 2/2016 Aoki et al.
 D760,846 S 7/2016 Castro et al.
 D762,258 S * 7/2016 Jenkins D18/4.5
 D763,247 S * 8/2016 Yepez D14/307
 RE46,169 E 10/2016 Kelly et al.
 D770,450 S * 11/2016 Bae D14/341
 D772,335 S * 11/2016 Mantrawadi D18/4.6
 9,542,814 B2 1/2017 Daniels
 9,547,958 B2 1/2017 Cole et al.
 D782,466 S * 3/2017 Yepez D14/307
 D801,945 S * 11/2017 Cho D14/138 G
 D806,159 S * 12/2017 Haller D18/4.5
 D808,354 S 1/2018 Castro et al.
 D809,067 S * 1/2018 Steelman D21/325
 D811,384 S * 2/2018 Diasabeygunawardena
 D14/336
 D812,145 S * 3/2018 Huang D21/369
 D812,146 S 3/2018 Castro et al.
 D812,147 S 3/2018 Castro et al.
 D812,148 S 3/2018 Castro et al.
 D812,149 S 3/2018 Castro et al.
 D818,524 S * 5/2018 Dong D18/4.4

D819,747 S 6/2018 Castro et al.
 D825,668 S * 8/2018 Hedrick D21/397
 D833,535 S * 11/2018 Lim D21/370
 D835,184 S * 12/2018 Sorio D18/4.5
 D836,164 S * 12/2018 Castro D21/369
 10,207,187 B2 * 2/2019 Zoloto A63F 13/54
 D842,929 S * 3/2019 Hung D21/325
 D842,930 S * 3/2019 Johnson D21/369
 D843,458 S * 3/2019 Castro D21/369
 D843,466 S * 3/2019 Castro D21/369
 D843,467 S * 3/2019 Johnson D21/369
 D843,471 S * 3/2019 Castro D21/369
 D843,472 S * 3/2019 Castro D21/369
 D843,476 S * 3/2019 Lesley D21/369
 D843,477 S * 3/2019 Lesley D21/369
 D843,478 S * 3/2019 Lesley D21/369
 D843,479 S * 3/2019 Castro D21/369
 D843,480 S * 3/2019 Castro D21/369
 D844,046 S * 3/2019 Yeruva D18/4.5
 D844,062 S * 3/2019 Lesley D21/369
 D846,649 S * 4/2019 Schoonmaker D21/369
 D849,832 S * 5/2019 Baker D18/4.5
 D850,525 S * 6/2019 Eun D18/4.6
 D850,536 S * 6/2019 Stair D21/370
 10,325,446 B2 * 6/2019 Castro G07F 17/322
 D853,346 S * 7/2019 Jang D14/140.8
 2002/0041069 A1 4/2002 Steelman
 2003/0122973 A1 7/2003 Huang
 2004/0018877 A1 1/2004 Tastad et al.
 2004/0029631 A1 2/2004 Duhamel
 2004/0053662 A1 3/2004 Pacey
 2005/0014547 A1 1/2005 Gomez et al.
 2006/0009284 A1 1/2006 Schwartz et al.
 2006/0028159 A1 2/2006 Otomo et al.
 2006/0034042 A1 2/2006 Hisano et al.
 2006/0079316 A1 4/2006 Flemming et al.
 2006/0131810 A1 6/2006 Nicely
 2006/0183553 A1 8/2006 Kiriya et al.
 2006/0199638 A1 9/2006 Walker et al.
 2006/0287111 A1 12/2006 Mitchell et al.
 2008/0039213 A1 2/2008 Cornell et al.
 2008/0051202 A1 2/2008 Lube
 2009/0174996 A1 7/2009 Park
 2009/0221375 A1 9/2009 Luciano, Jr. et al.
 2010/0053231 A1 3/2010 Park
 2012/0122569 A1 5/2012 Kowolik et al.
 2012/0168058 A1 7/2012 Kim et al.
 2013/0180653 A1 7/2013 Kim et al.
 2013/0278875 A1 10/2013 Kim et al.
 2014/0055696 A1 2/2014 Lee et al.
 2014/0092356 A1 4/2014 Ahn et al.
 2014/0176856 A1 6/2014 Lee et al.
 2014/0226111 A1 8/2014 Kim
 2014/0226112 A1 8/2014 Kim
 2014/0354938 A1 12/2014 Kim
 2014/0368782 A1 12/2014 Kim et al.
 2014/0375963 A1 12/2014 Bishop
 2015/0000823 A1 1/2015 Kim et al.
 2015/0036073 A1 2/2015 Im et al.
 2015/0116621 A1 4/2015 Park et al.
 2015/0116625 A1 4/2015 Hwang et al.
 2015/0301390 A1 10/2015 Kim
 2017/0039803 A1 * 2/2017 Lesley G07F 17/3216
 2018/0078854 A1 * 3/2018 Achmueller A63F 13/20
 2018/0342129 A1 * 11/2018 Wudtke G07F 17/3211
 2019/0080547 A1 * 3/2019 Urban G07F 17/322

FOREIGN PATENT DOCUMENTS

AU 201811906 4/2018
 AU 201811186 5/2018
 EP 649 671 A1 4/1995
 JP 03210172 B2 9/2001
 KR 10-1113734 B1 2/2012
 KR 10-2012-0051630 5/2012
 KR 10-1268471 B1 6/2013
 KR 10-1278904 B1 6/2013
 KR 10-1336677 B1 12/2013
 KR 10-1381609 B1 4/2014

(56)

References Cited

FOREIGN PATENT DOCUMENTS

KR	10-1381610	B1	4/2014
KR	10-2015-0013987		2/2015
KR	10-1539221	B1	7/2015
TW	200949775	A	12/2009

OTHER PUBLICATIONS

Brochure for “Virtual Pinball,” Tab-Austria, 2007 (8 pages).
 Cabinet Brochure for Hydako Co., date estimated as early as 2009 (1 page).
 Catalog for “Your Partner Innovation,” Bally Technologies, date estimated as early as 2011 (4 pages).
 Catalog for Atronic®-Spielo®, date estimated as early as 2008 (2 pages).
 Cohran; “Why Samsung’s curved-screen TV might be a ‘game changer’”; CBS News; Aug. 14, 2013; retrieved from <<http://www.cbsnews.com/news/why-samsungs-curved-screen-tv-might-be-a-game-changer/>> (3 pages).
 DailyTech; “AUO Shows Off Curved Display and Touch Screen”; May 23, 2008; retrieved from <<http://www.dailytech.com/AUO+Shows+Off+Curved+Display+and+Touch+Screen+Tech/article11845.htm>> on Mar. 3, 2017 (2 pages).
 Daniel; “Curved Monitors—Overview”; Curved Monitor Test; Aug. 28, 2015; retrieved from <<http://www.curved-monitor-test.de/>> (5 pages).
 Denison; “Why can’t you buy a flat OLED yet? The curve isn’t just about viewing experience”; Digital Trends; Aug. 18, 2013; retrieved from <<http://www.digitaltrends.com/home-theater-why-did-the-us-get-stuck-with-curved-oled/#!zXypT>> (8 pages).
 DigiTimes Inc.; “FPD China 2009: AUO 8.9-inch convex display panel”; Mar. 12, 2009; retrieved from <<http://www.digitimes.com/photogallery/showphoto.asp?ID=3376>> on Mar. 3, 2017 (3 pages).
 Fall & Winter Catalog for Aristocrat, date estimated as early as 2010-2011 (7 pages).
 Gizmodo.com; “AUO Curved Displays, Ultra Thin LCDs On the Way”; May 20, 2008; retrieved from <<http://gizmodo.com/392248/auo-curved-displays-ultra-thin-lcds-on-the-way>> on Mar. 3, 2017 (2 pages).
 Immersaview; “Why choose a Curved Screen for your Multi-Projector Setup”; Jan. 28, 2016; retrieved from <<https://www.immersaview.com/resources/why-curved/>> (7 pages).
 Kelly; “TV trends at CES: 4K, curves and smart TVs”; CNN; Jan. 8, 2014; retrieved from <<http://www.cnn.com/2014/01/07/tech/gaming-gadgets/ces-television-trends/>> (5 pages).
 Ljt216; “Flat Screen vs Curved CRTs for Retro Games”; Reddit; Jul. 29, 2015; retrieved from <https://www.reddit.com/r/gamecollecting/comments/3f25r0/flat_screen_vs_curved_crts_for_retro_games/> (4 pages).
 Manjoo; “TV Makers Are Out of Ideas”; Wall Street Journal; Jan. 8, 2014; retrieved from <<https://www.wsj.com/news/articles/SB100014240527023033938045790308801012230792>> (4 pages).

Matthias; “Curved TV—Overview”; Curved TV Test; Apr. 20, 2016; retrieved from <<http://technikblog.net/fernseher-test/curved-tv/>> (16 pages, in German).
 Morrison; “Curved OLED HDTV screens are a bad idea (for now)”; CNET; Jun. 18, 2013; retrieved from <<https://www.cnet.com/news/curved-oled-hdtv-screens-are-a-bad-idea-for-now/>> (9 pages).
 NewLaunches.com; “LG Phillips LCD develops world’s highest resolution 14.3-inch flexible color E-paper display!”; Jan. 3, 2008; retrieved from <http://newlaunches.com/archives/lgphillips_lcd_develops_worlds_highest_resolution_143inch_flexible_color_epaper_display.php> (4 pages).
 OLED-Info; “LG Phillips LCD Develops 14.3-Inch Color E-Paper Display”; Jan. 4, 2008; retrieved from <http://www.oled-info.com/lg/lg_phillips_lcd_develops_14_3_inch_color_e_paper_display>; (2 pages).
 PC World; “AU Optronics Shows off Curved LCD Screen”; May 20, 2008; retrieved from <<http://www.pcworld.com/article/146083/article.asp.html>> on Mar. 3, 2017 (3 pages).
 Photonics industry and Technology Development Association (PIDA); “E-Paper Shows Potential at Creating a Paperless Haven”; OptoLink Magazine, 3 Quarter 2008; pp. 8-11 (4 pages).
 Product Catalog for “Alpha Elite™,” Bally Technologies, date estimated as early as 2008-2009 (2 pages).
 Product Catalog for Ainsworth Game Technology Ltd, date estimated as early as 2007 (6 pages).
 Product Catalog for Bally Technologies, date estimated as early as 2010 (2 pages).
 Product Sheet for “3RV™,” WMS Gaming In., 2002 or earlier (2 pages).
 Product Sheet for “American Eagle,” Eagle Co. Ltd., 1997 (2 pages).
 Product Sheet for “American Eagle,” Eagle Co., Ltd., 2000 (2 pages).
 Product Sheet for “EVO™ Hybrid,” Bally Gaming Systems, 2002 (4 pages).
 Product Sheet for “Miss America,” AC Coin & Slot, 2002 or earlier (2 pages).
 Product Sheet for “Monopoly Chairman of the Board™,” WMS Gaming Inc., 1999 (2 pages).
 Product Sheet for “ProSLOT® 6000,” Bally Gaming Systems, 2002 (4 pages).
 Product Sheet for “Survivor,” WMS Gaming Inc., 2001 (4 pages).
 Product Sheet for “Ultrapin™,” Global VR, 2007 (1 pages).
 Snider; “Sony tosses latest pitch for curved TV displays”; USA Today; Oct. 15, 2013; retrieved from <<http://www.usatoday.com/story/tech/personal/2013/10/15/new-curved-sony-led-hdtv/2982051/>> (2 pages).
 Wilcox; “LG, Samsung, and Sony throw TV buyers a curve”; Consumer Reports; Sep. 10, 2013; retrieved from <<http://www.consumerreports.org/cro/news/2013/09/curved-tv-screens/index.htm#>> (1 page).
 Wood, M., Major, C., Carr, V. eds.; “Curved Screens: Worth It?” video found at <<http://www.nytimes.com/video/technology/personaltech/10000002788325/curved-screens-worth-it.html>>; New York Times; Mar. 26, 2014.

* cited by examiner

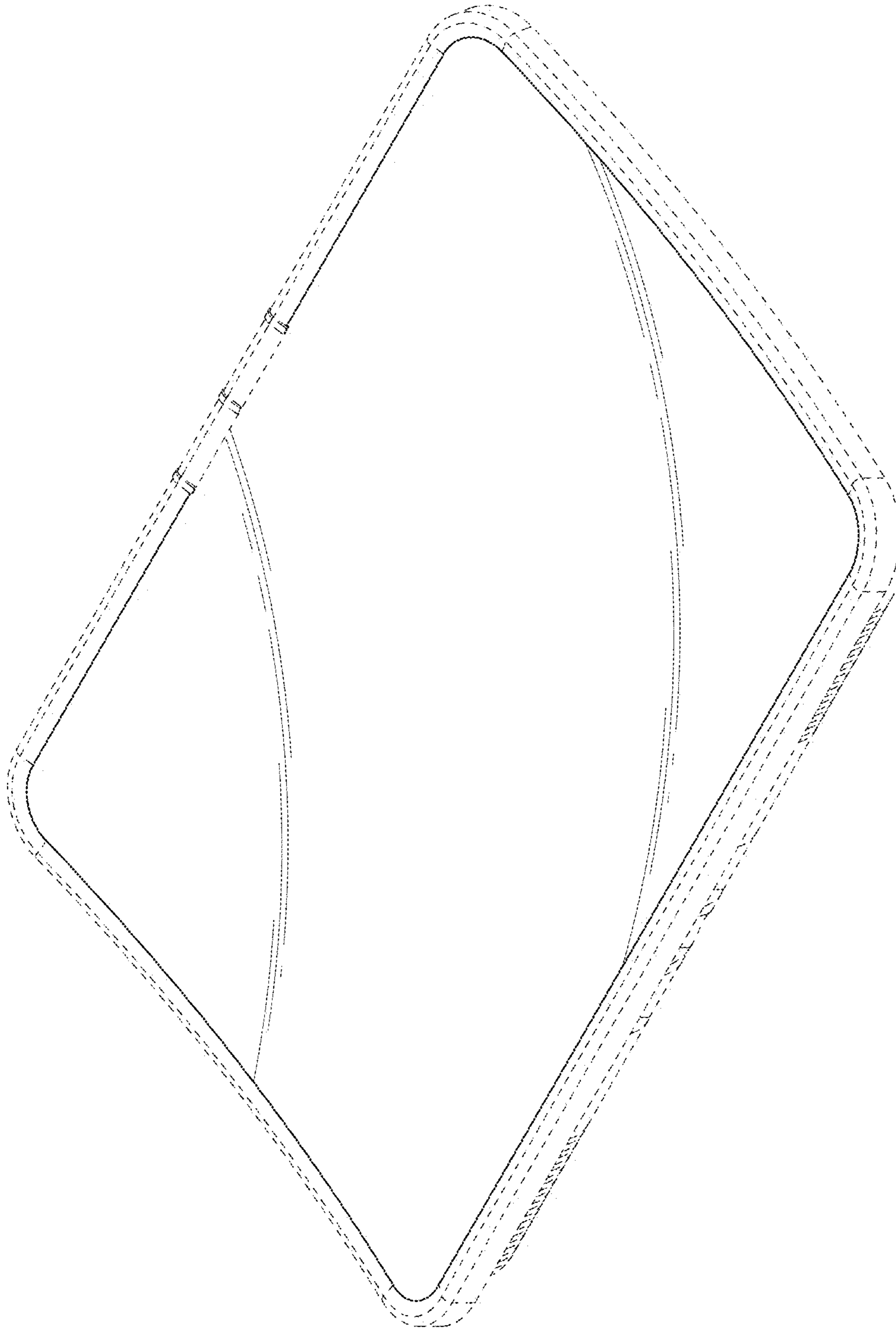

FIG. 1

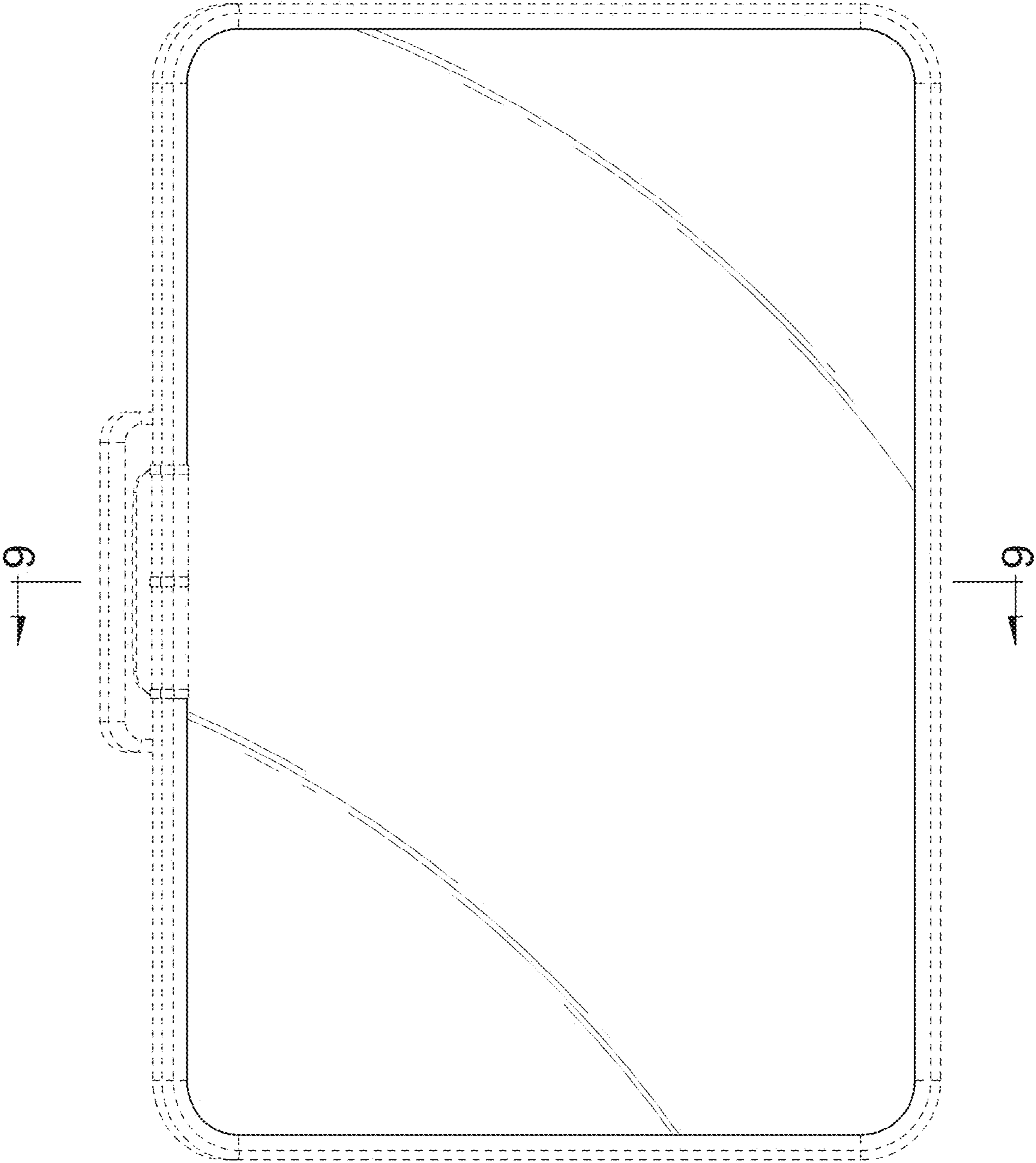

FIG. 2

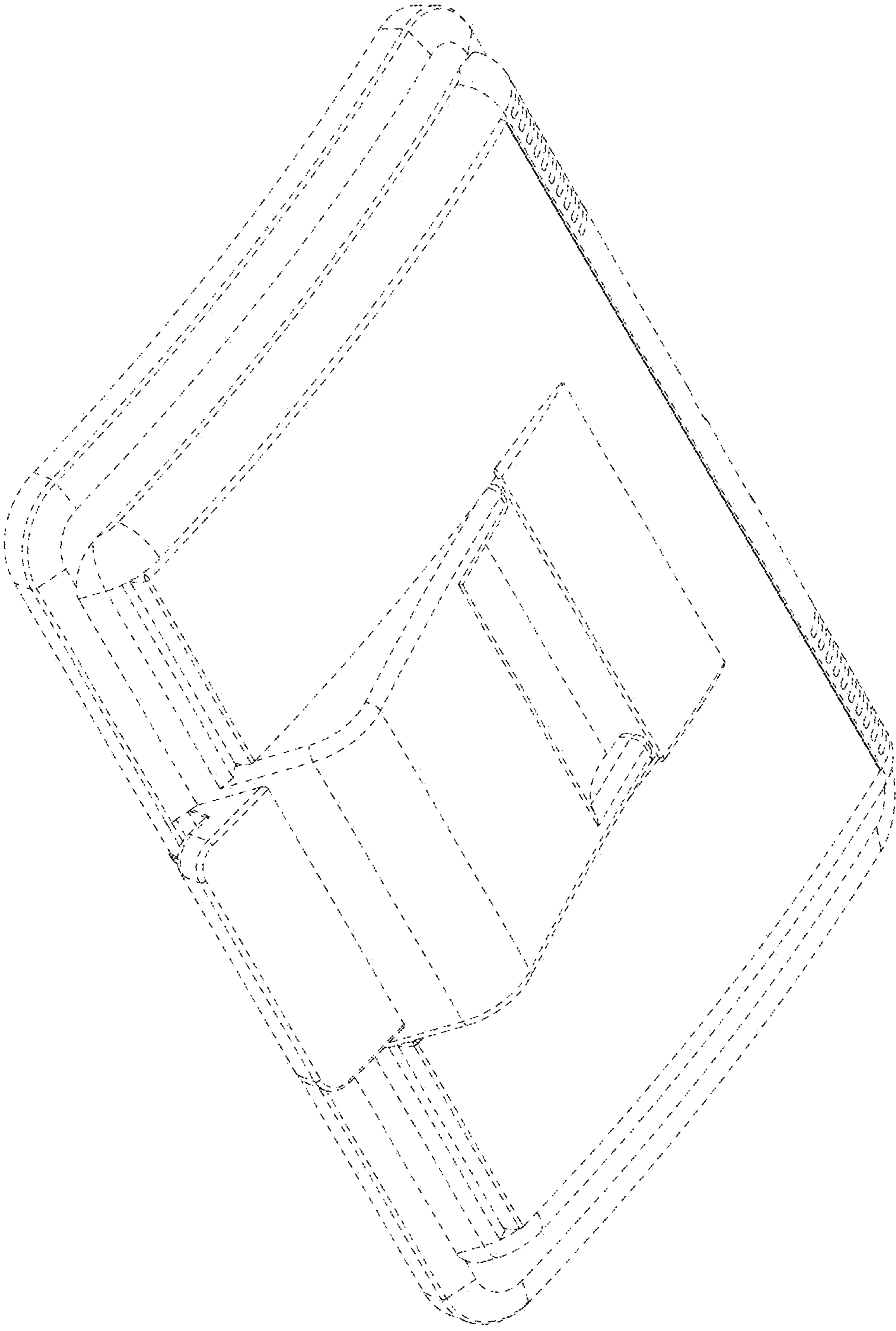

FIG. 3

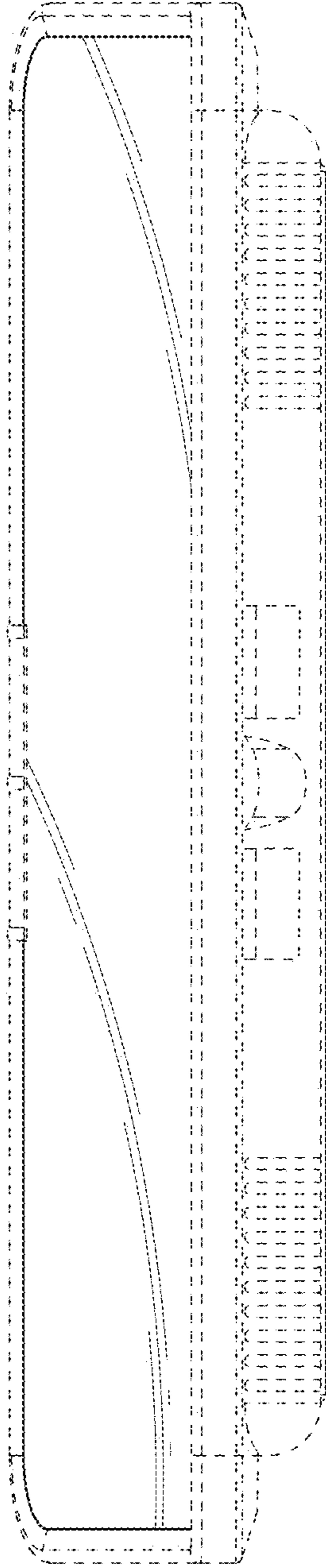

FIG. 4

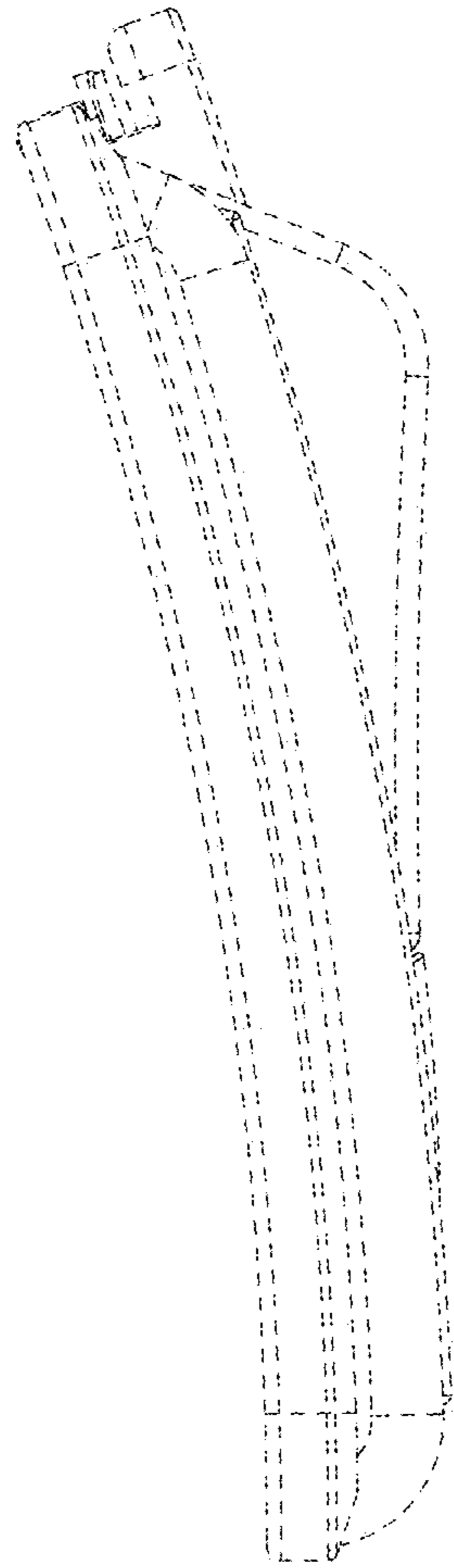

FIG. 5

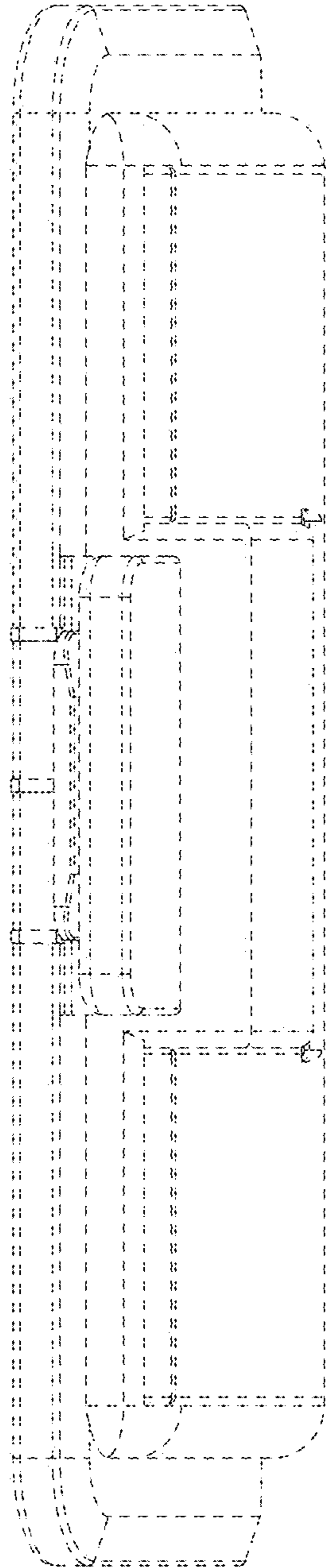

FIG. 6

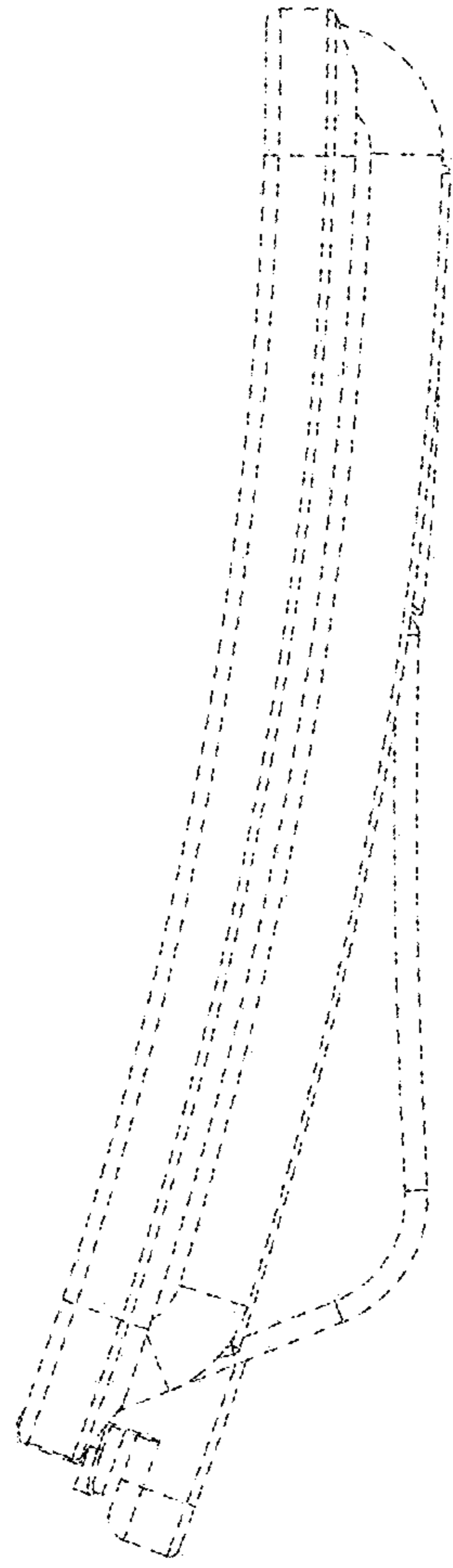

FIG. 7

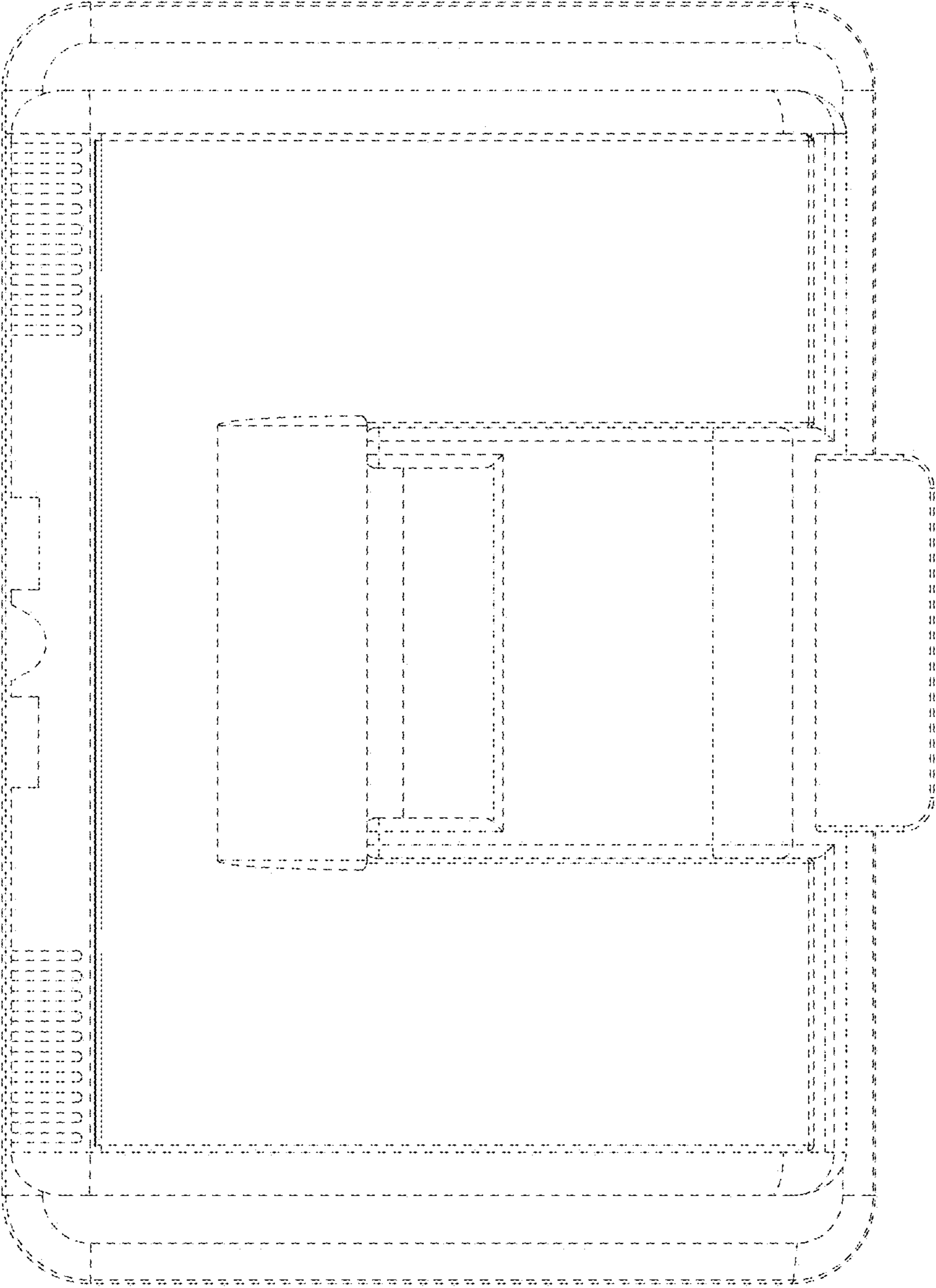

FIG. 8

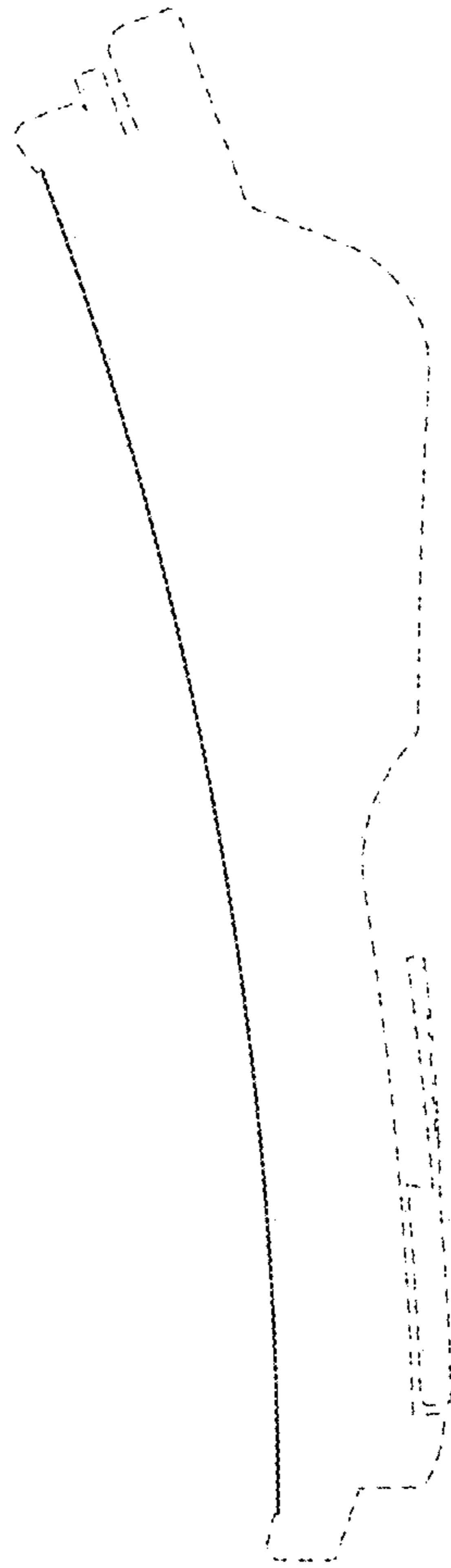

FIG. 9

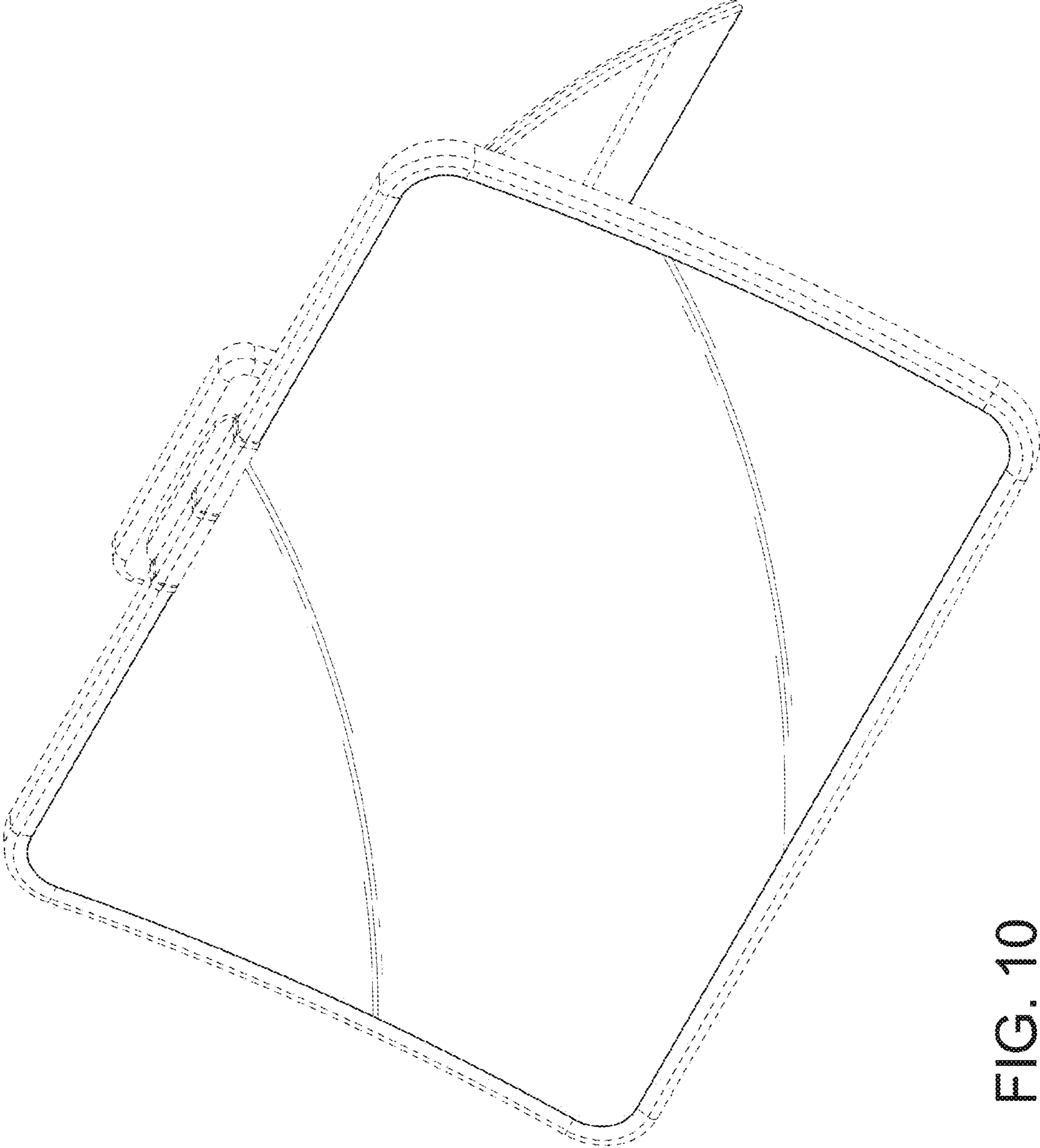

FIG. 10

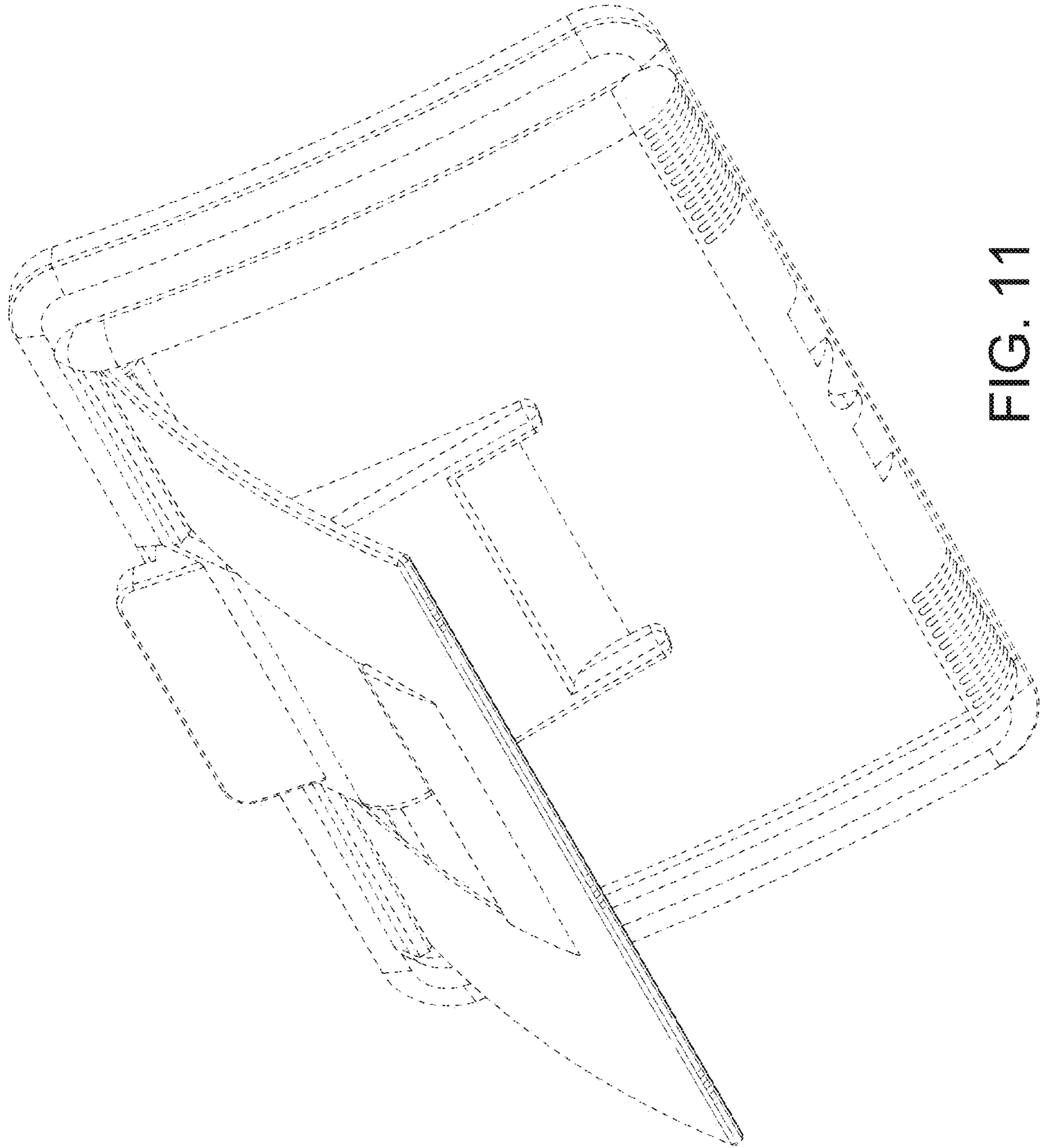

FIG. 11

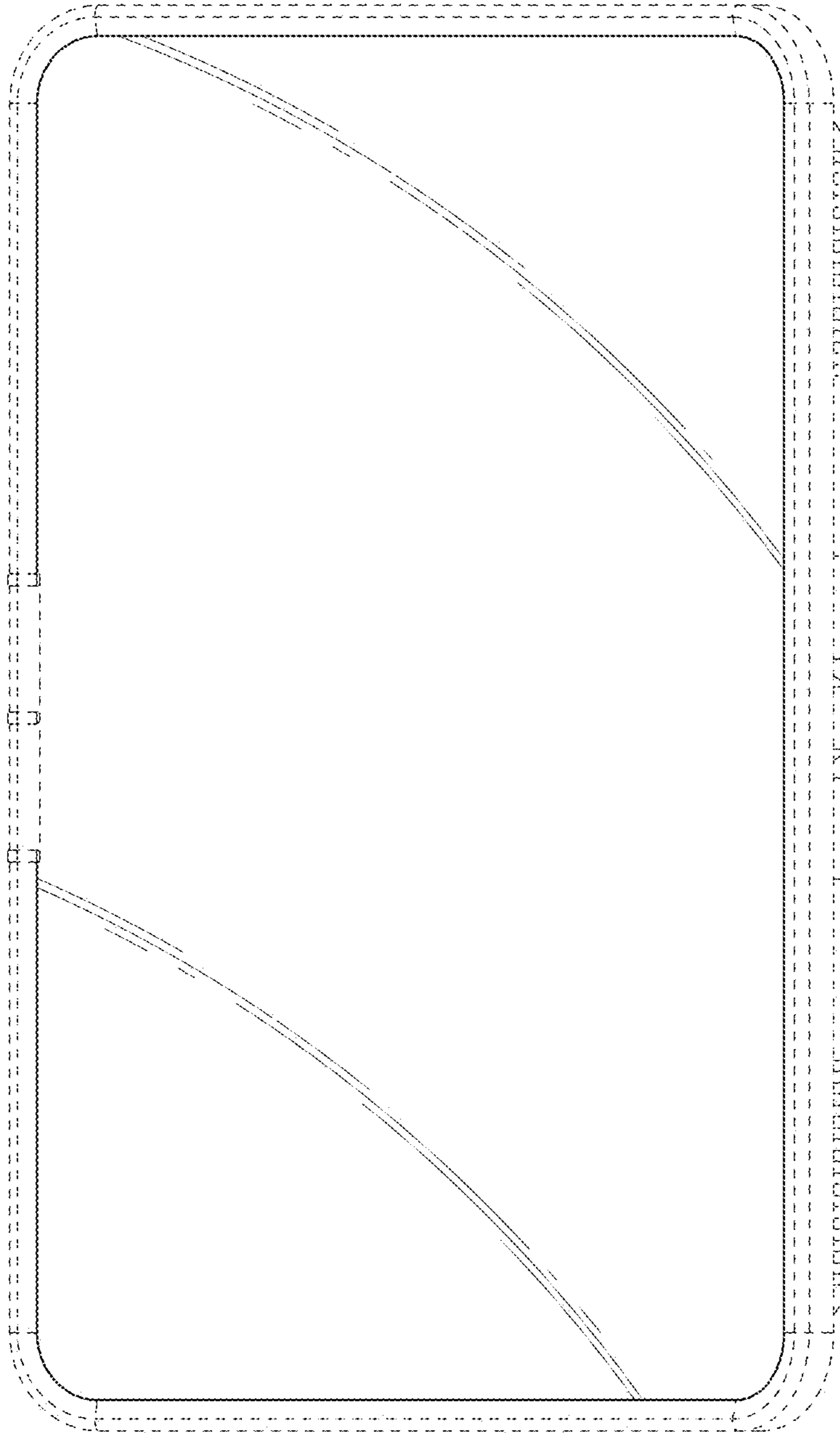

FIG. 12

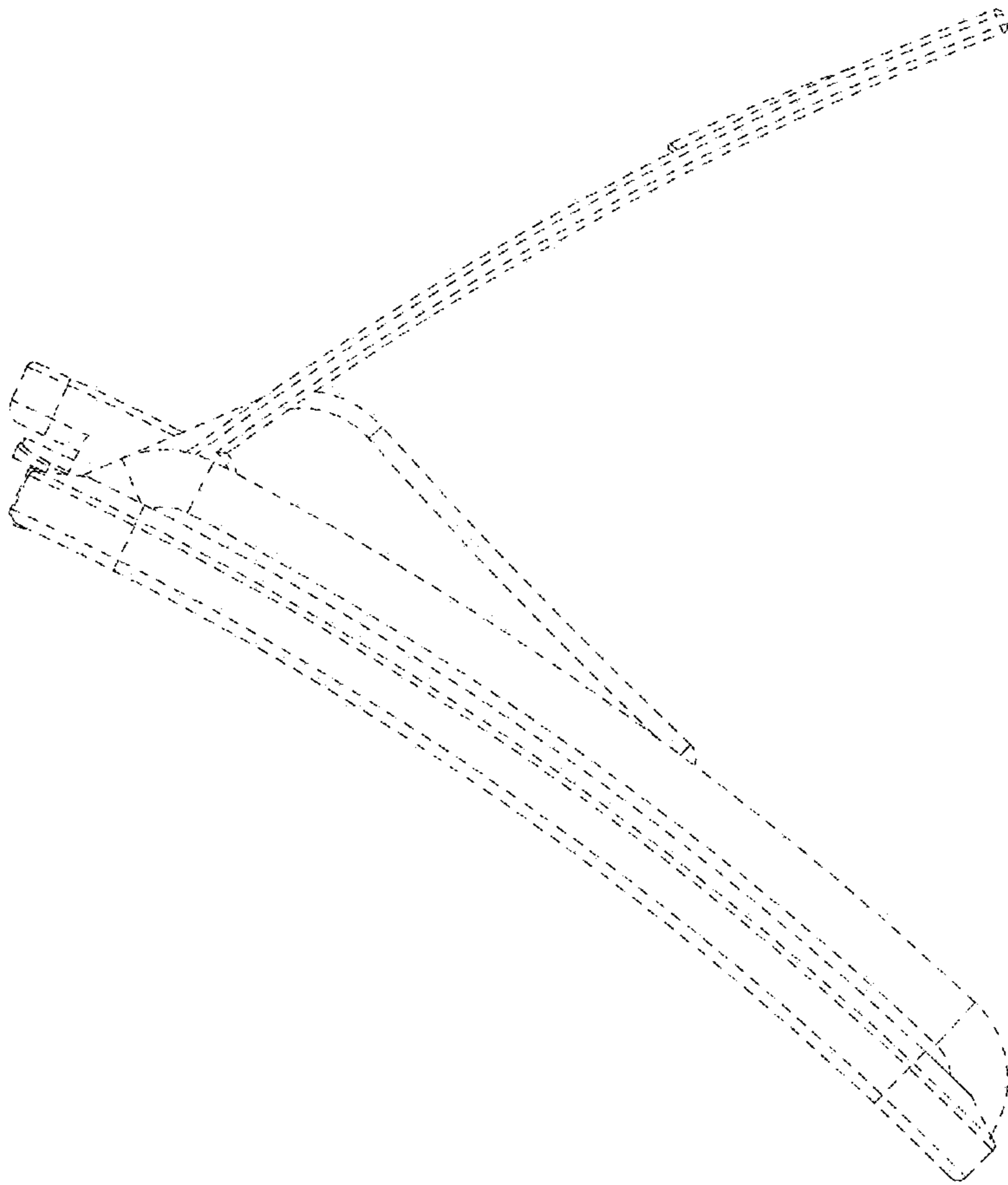

FIG. 13

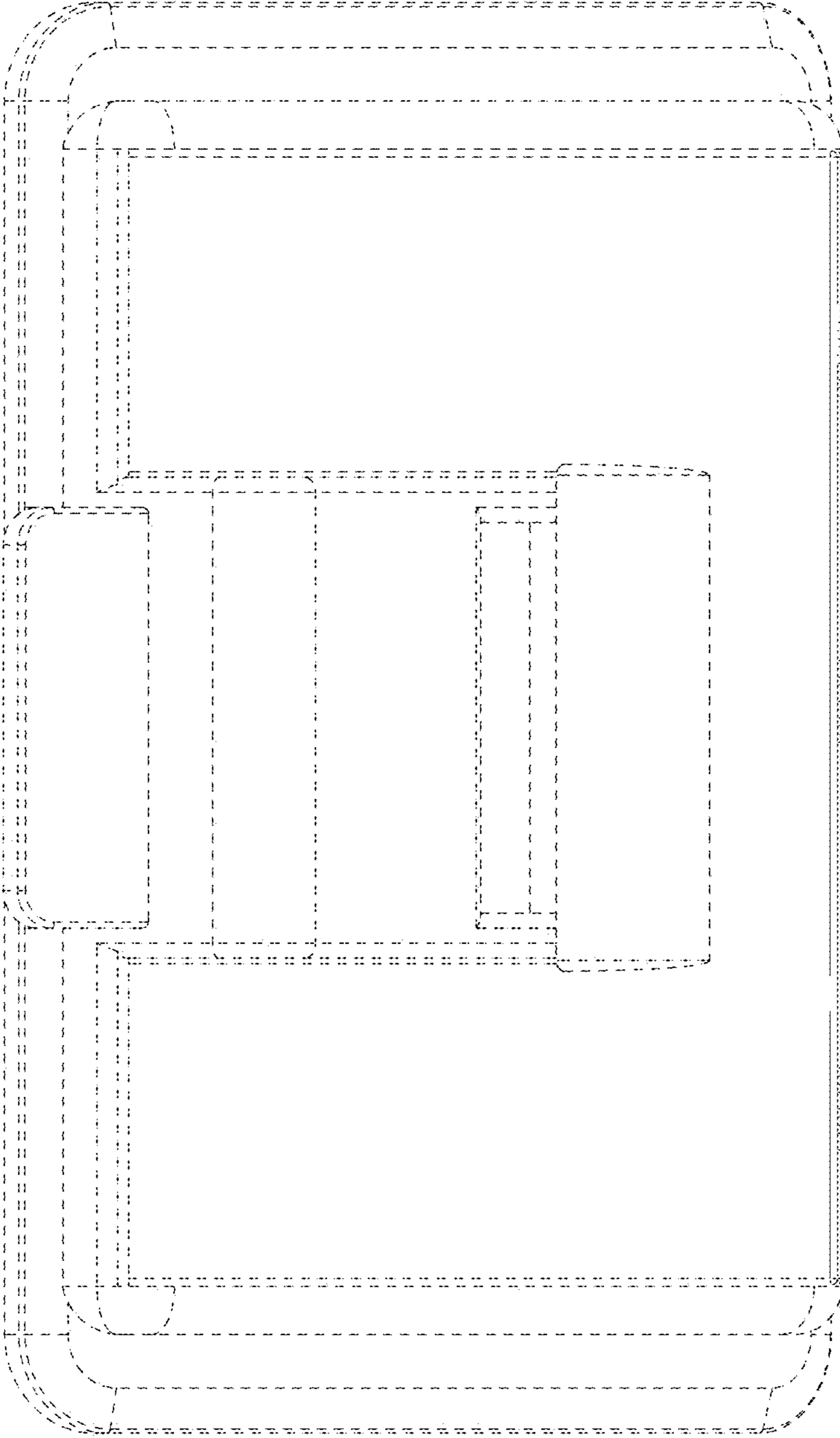

FIG. 14

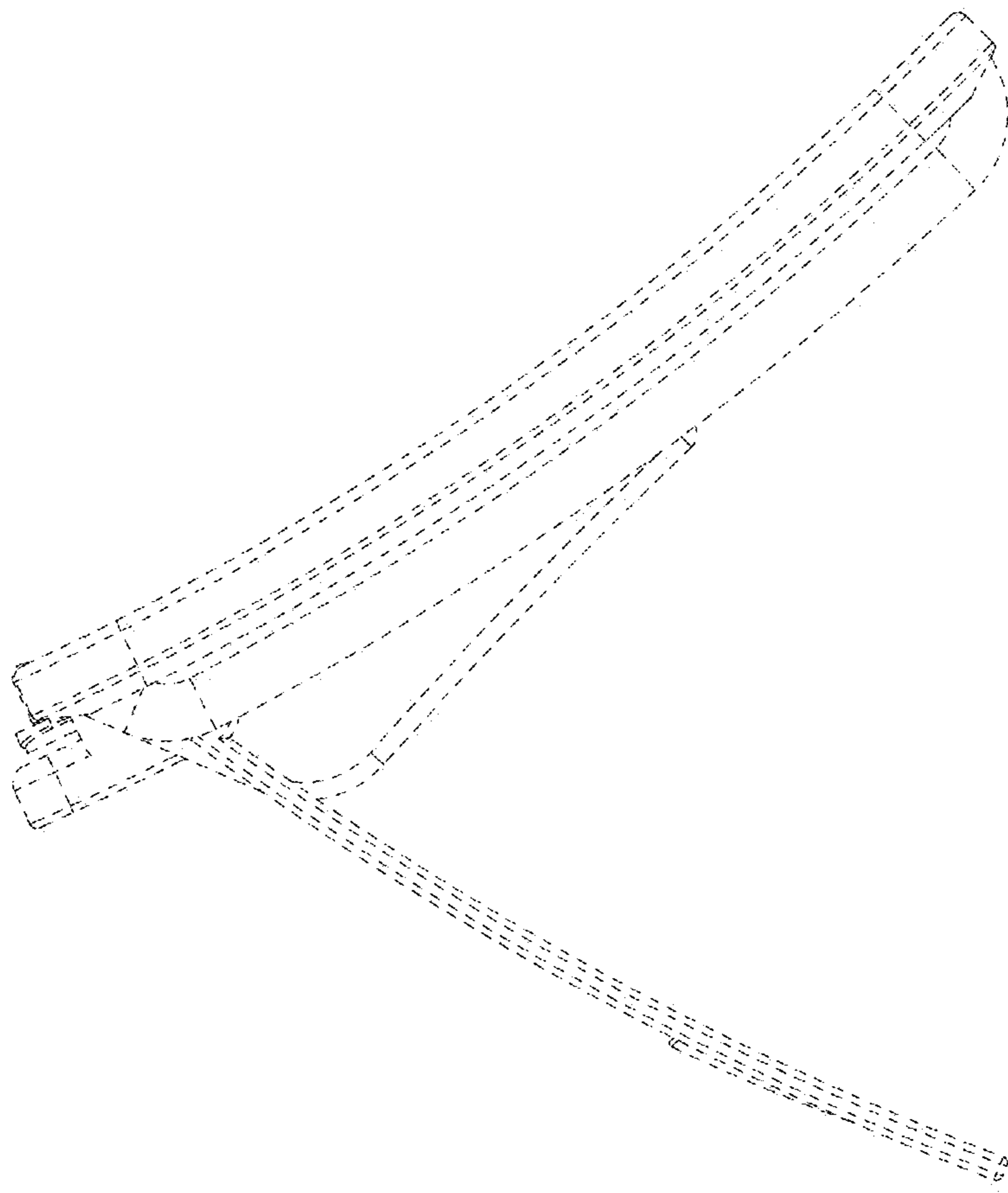

FIG. 15

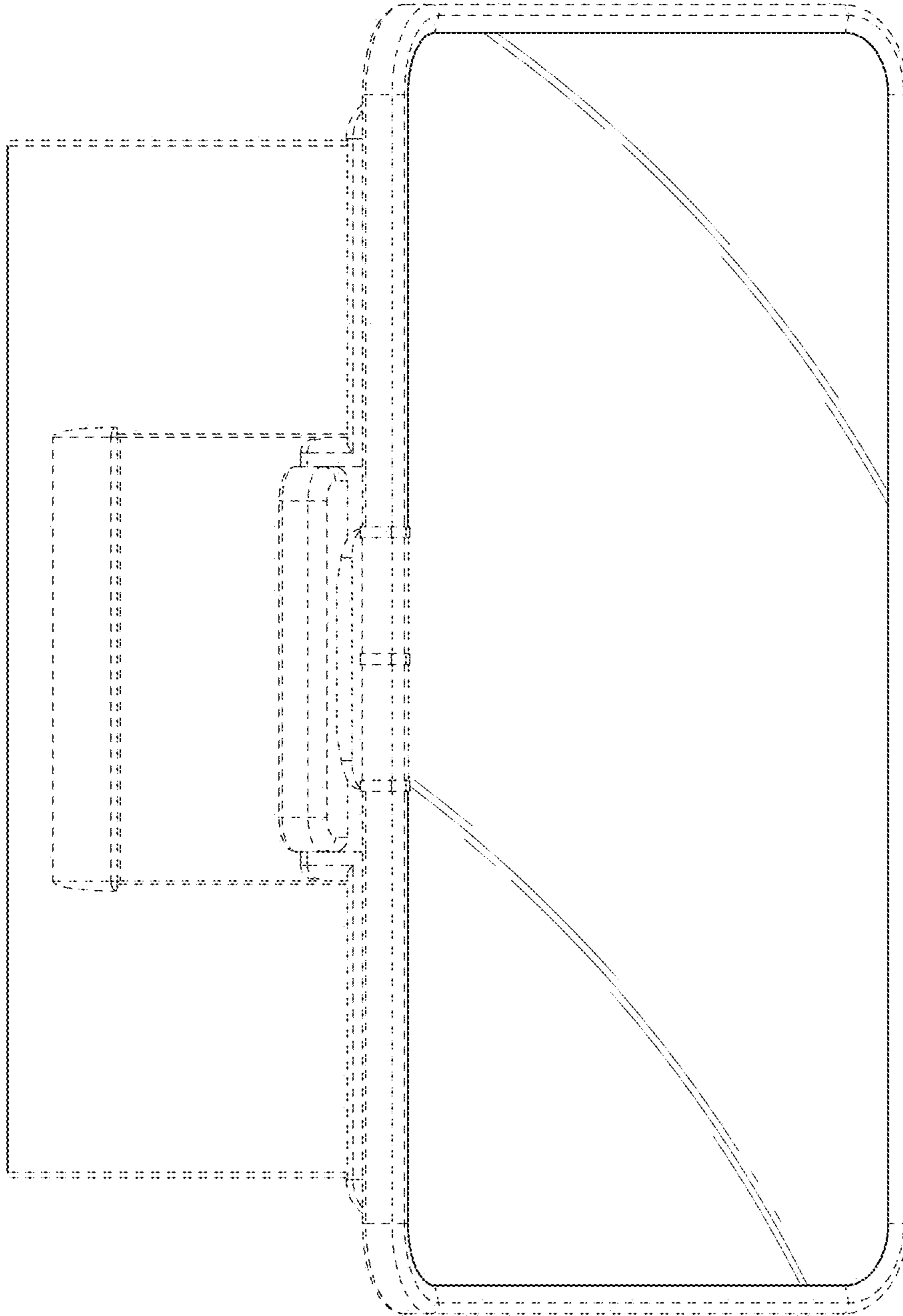

FIG. 16

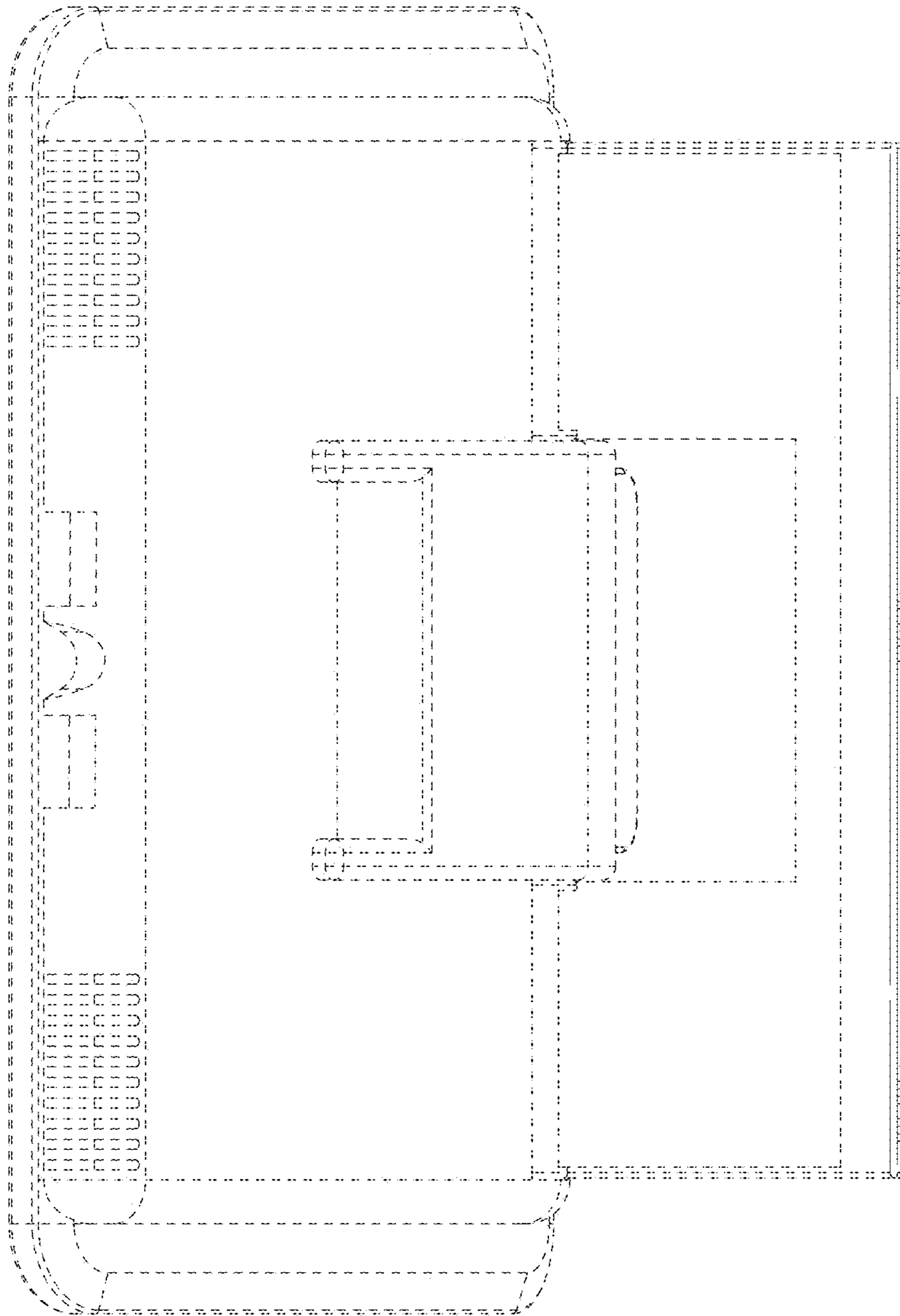

FIG. 17