



US00D887493S

(12) **United States Design Patent**  
**Brown**

(10) **Patent No.:** **US D887,493 S**

(45) **Date of Patent:** **\*\* Jun. 16, 2020**

(54) **DOOR COVER**

(71) Applicant: **Rowena Brown**, Bronx, NY (US)

(72) Inventor: **Rowena Brown**, Bronx, NY (US)

(\*\*) Term: **15 Years**

(21) Appl. No.: **29/650,983**

(22) Filed: **Jun. 11, 2018**

(51) **LOC (12) Cl.** ..... **20-03**

(52) **U.S. Cl.**  
USPC ..... **D20/42**

(58) **Field of Classification Search**

USPC ..... D20/10, 19, 42, 99; D11/165; D6/610  
CPC .... G09F 7/00; G09F 2007/1808; G09F 15/00;  
G09F 19/00; G09F 19/22; G05F 15/0025;  
E06B 5/00; B44C 5/0046; B60J 1/2011;  
B60J 11/06

See application file for complete search history.

(56) **References Cited**

**U.S. PATENT DOCUMENTS**

- 856,221 A \* 6/1907 Bufe ..... E06B 9/52  
160/184
- 5,123,223 A \* 6/1992 Makarevich ..... B44C 5/0446  
206/325
- 6,308,474 B1 \* 10/2001 Wilson ..... E04G 21/30  
150/154
- 6,491,052 B1 \* 12/2002 Zheng ..... E04H 15/40  
135/125
- 6,648,396 B2 \* 11/2003 Monahan ..... B60J 1/2011  
160/370.21
- D486,529 S \* 2/2004 Valenzuela ..... D20/41
- D763,131 S \* 8/2016 Skinner ..... B44C 5/0446  
D11/165

- D789,245 S \* 6/2017 Skinner ..... B60J 1/2011  
D11/165
- D792,279 S \* 7/2017 Skinner ..... E04H 15/40  
D11/165
- 2003/0026940 A1\* 2/2003 Bullock ..... B44C 5/04  
428/99
- 2006/0027344 A1\* 2/2006 Lampe ..... G09F 19/22  
160/209
- 2007/0006498 A1\* 1/2007 Collins ..... G09F 1/06  
40/610
- 2009/0293364 A1\* 12/2009 Garstad ..... E05B 1/00  
49/70
- 2014/0251554 A1\* 9/2014 Rainaldi ..... E06B 3/7001  
160/103
- 2019/0043391 A1\* 2/2019 Holyfield ..... G09F 17/00

\* cited by examiner

*Primary Examiner* — Mary Ann Calabrese

(74) *Attorney, Agent, or Firm* — Bruce A. Lev

(57) **CLAIM**

The ornamental design for a door cover, as shown and described.

**DESCRIPTION**

FIG. 1 is a rear perspective view of a door cover showing my new design.  
FIG. 2 is a front elevation view thereof;  
FIG. 3 is a rear elevation view thereof;  
FIG. 4 is a left side view thereof;  
FIG. 5 is a right side view thereof;  
FIG. 6 is a top plan view thereof; and,  
FIG. 7 is a bottom plan view thereof.  
Broken lines are included for depicting environmental subject matter and form no part of the claimed design.

**1 Claim, 4 Drawing Sheets**

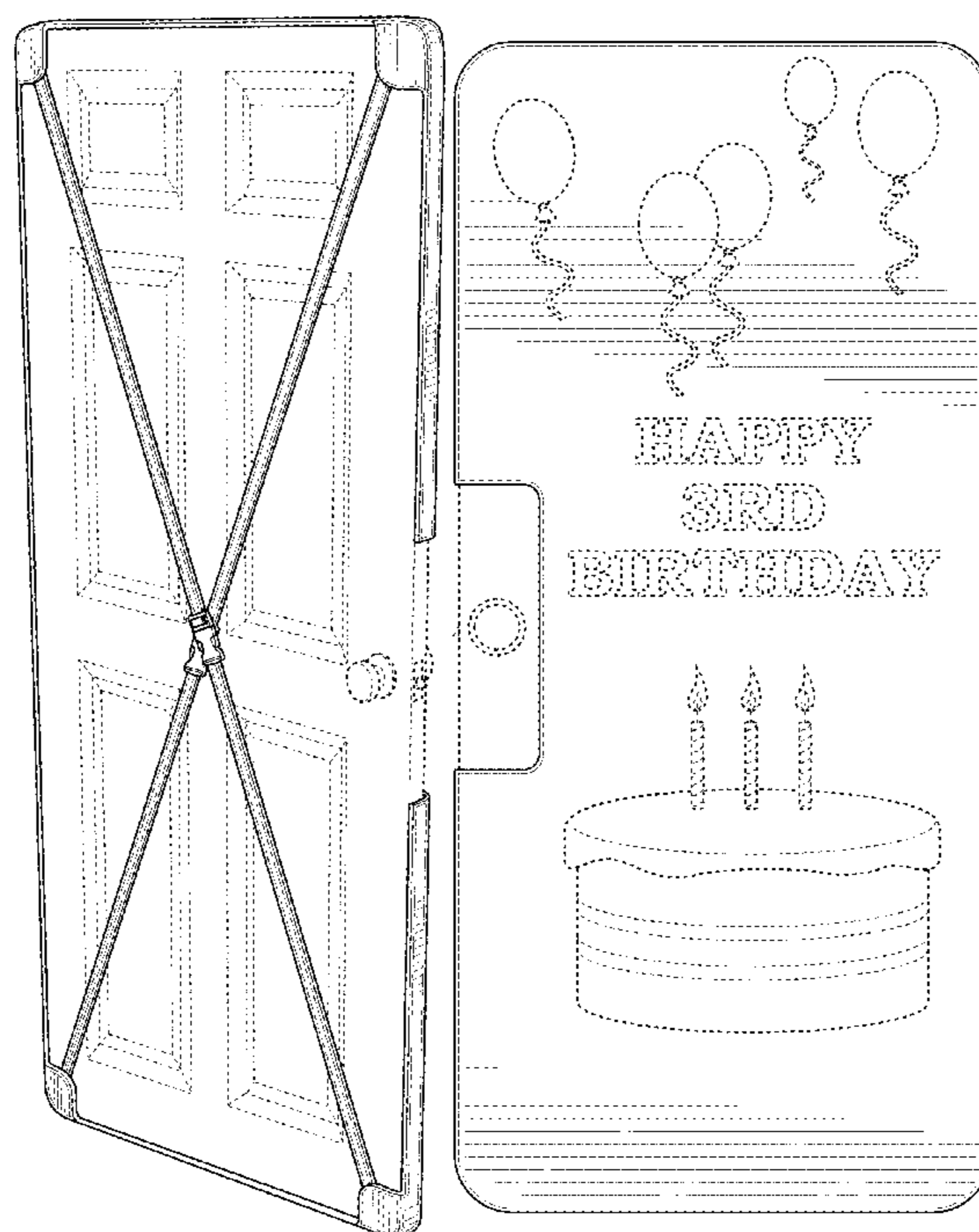

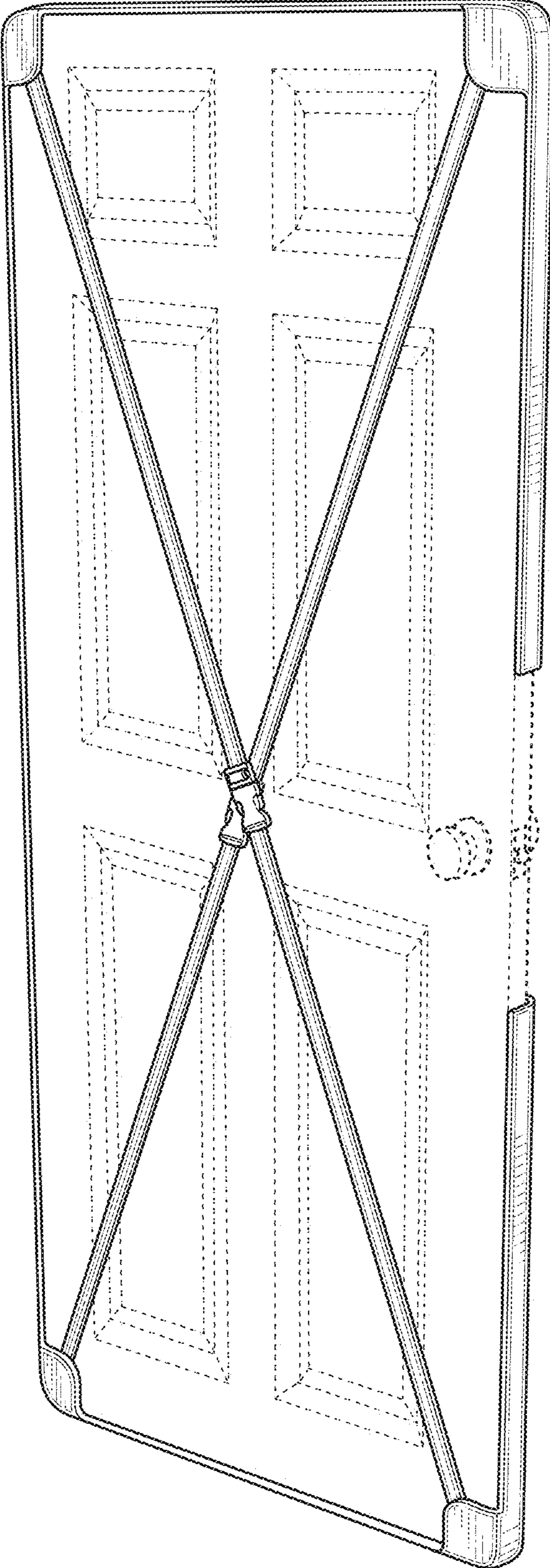

FIG. 1



FIG. 2

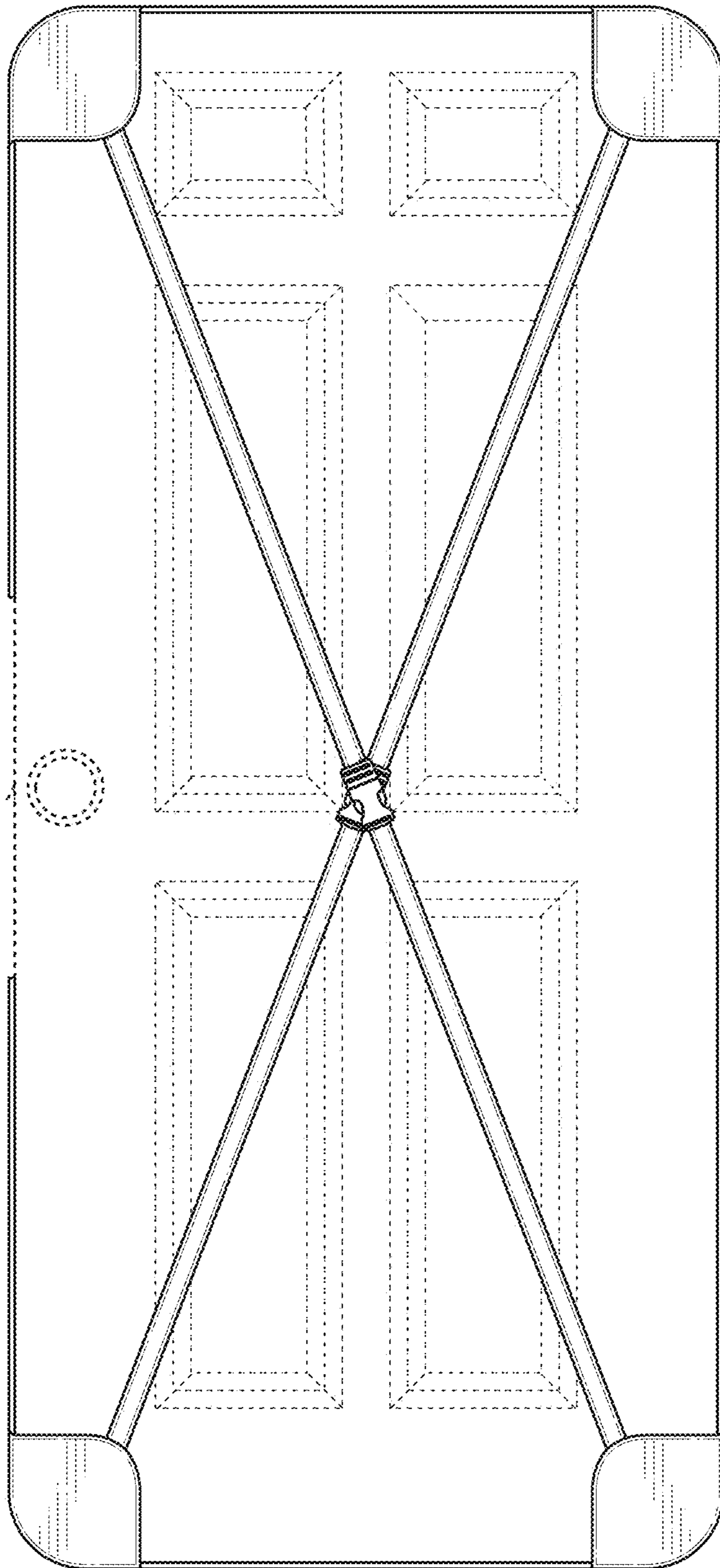

FIG. 3

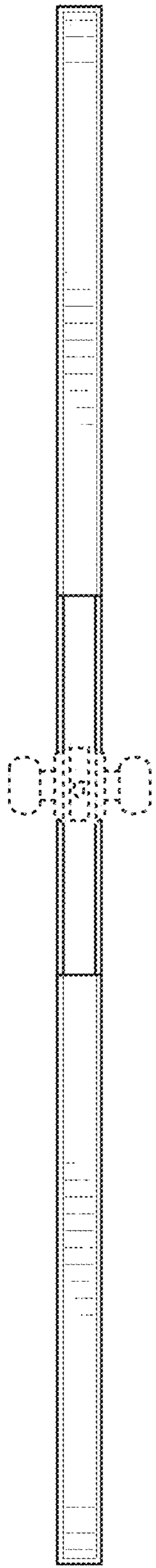

FIG. 4

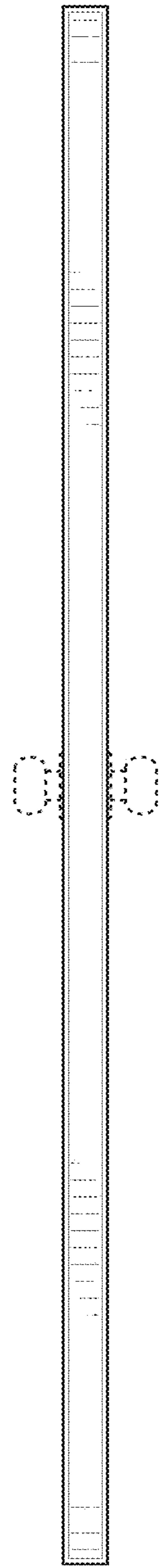

FIG. 5

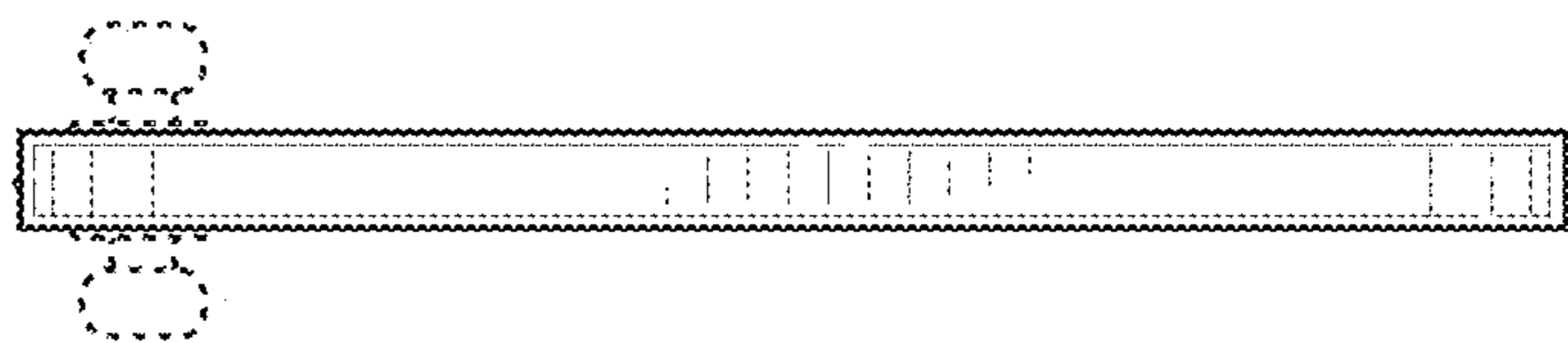

FIG. 6

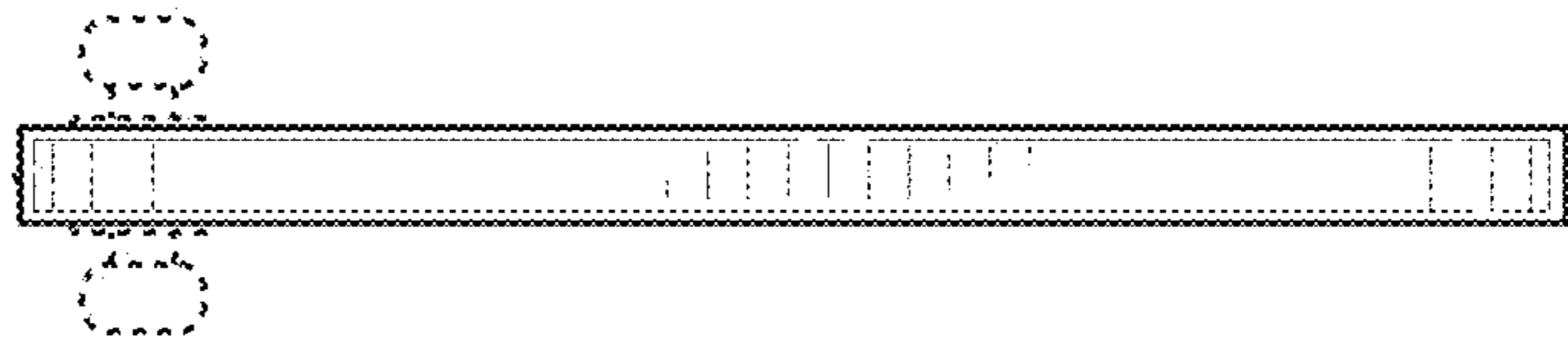

FIG. 7