



US00D887395S

(12) **United States Design Patent**
Wang

(10) **Patent No.:** **US D887,395 S**
(45) **Date of Patent:** **** Jun. 16, 2020**

- (54) **WIRELESS HEADSET**
- (71) Applicant: **Shenzhen Earfun Technology Co., Ltd.**, Shenzhen (CN)
- (72) Inventor: **Zili Wang**, Shenzhen (CN)
- (73) Assignee: **Shenzhen Earfun Technology Co., Ltd.**, Shenzhen (CN)

- D321,881 S * 11/1991 Hopewell D14/192
- D348,066 S * 6/1994 Lucey D14/205
- D387,764 S * 12/1997 Ross, Sr. D14/214
- D417,465 S * 12/1999 Kreitz D14/192
- 6,122,388 A * 9/2000 Feldman H04R 25/604
381/322
- D477,593 S * 7/2003 Komiyama D14/223
- D477,822 S * 7/2003 Komiyama D14/223

(Continued)

(**) Term: **15 Years**

(21) Appl. No.: **29/681,080**

(22) Filed: **Feb. 22, 2019**

(30) **Foreign Application Priority Data**

Jan. 10, 2019 (CN) 2019 3 0012281

(51) **LOC (12) Cl.** **14-01**

(52) **U.S. Cl.**
USPC **D14/223**

(58) **Field of Classification Search**
USPC D14/223, 205; D24/174; D13/107, 108;
455/90.3, 575.1, 569.1
CPC H04R 1/10; H04R 25/00; H04R 1/1016;
H04R 1/1066; H04R 5/033; H04R
5/0335; H04R 1/1091; H04R 1/1083;
A61F 11/08
See application file for complete search history.

(56) **References Cited**

U.S. PATENT DOCUMENTS

- D236,988 S * 9/1975 Walters D14/223
- 4,539,708 A * 9/1985 Norris H04B 1/088
455/100
- 4,585,089 A * 4/1986 Topholm H04R 25/65
181/135
- D287,765 S * 1/1987 Topholm D24/174
- D295,173 S * 4/1988 Oren D14/168
- 5,054,079 A * 10/1991 Frielingsdorf H04R 1/46
379/430

FOREIGN PATENT DOCUMENTS

- CN 305687904 * 4/2020
- CN 305715496 * 4/2020
- CN 305724685 * 4/2020

Primary Examiner — Paula Allen Greene

(74) *Attorney, Agent, or Firm* — ScienBiziP, P.C.

(57) **CLAIM**

The ornamental design for a wireless headset, as shown and described.

DESCRIPTION

FIG. 1 is a first perspective view of a wireless headset showing my design;

FIG. 2 is a second perspective view of the wireless headset of FIG. 1;

FIG. 3 is a front elevational view of the wireless headset of FIG. 1;

FIG. 4 is a rear elevational view of the wireless headset of FIG. 1;

FIG. 5 is a left side elevational view of the wireless headset of FIG. 1;

FIG. 6 is a right side elevational view of the wireless headset of FIG. 1;

FIG. 7 is a top plan view of the wireless headset of FIG. 1; and,

FIG. 8 is a bottom plan view of the wireless headset of FIG. 1.

The broken lines and unshaded regions bounded by broken lines form no part of the claimed design.

1 Claim, 8 Drawing Sheets

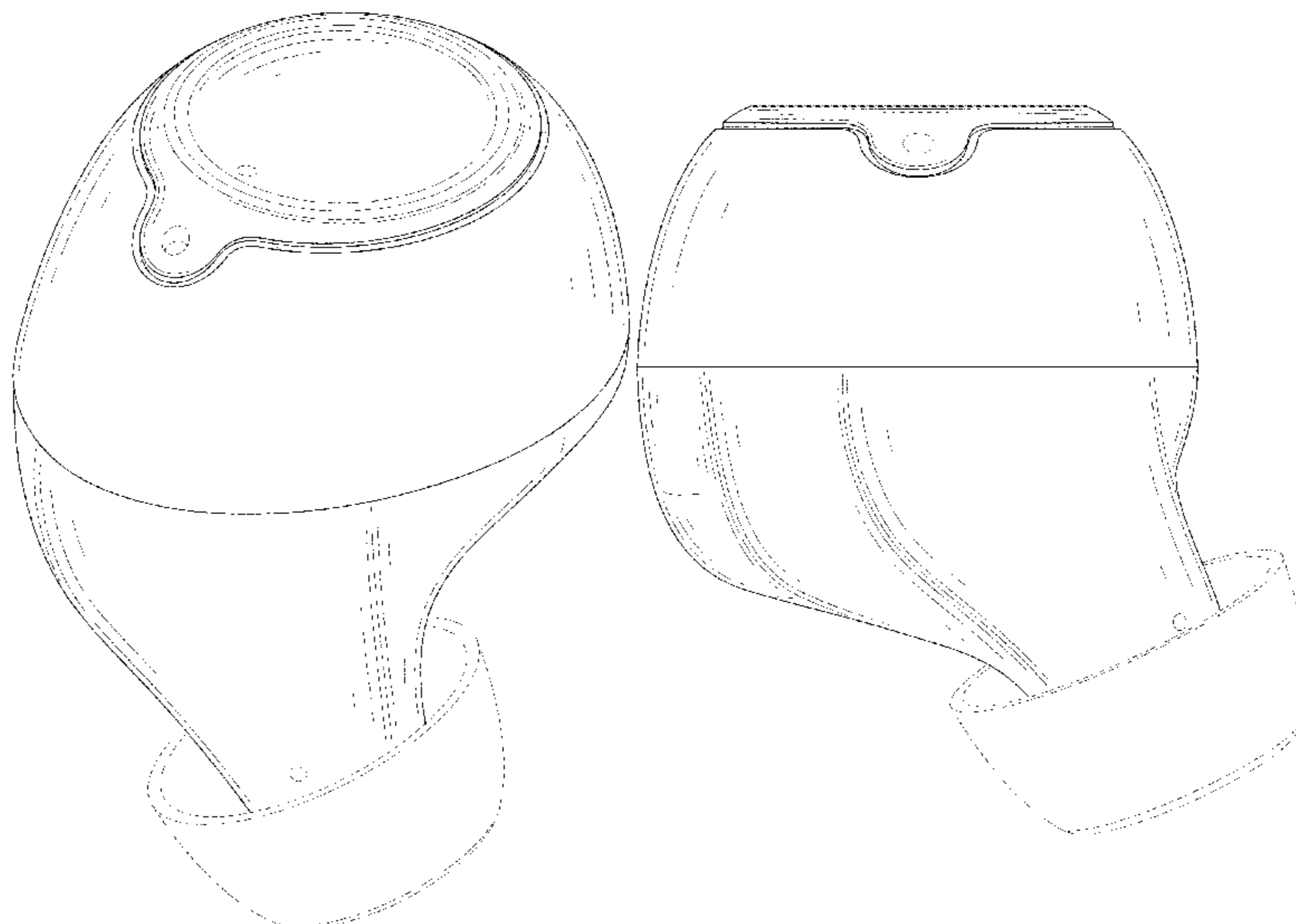

(56)

References Cited

U.S. PATENT DOCUMENTS

D481,709 S * 11/2003 Solderits D14/223
 D505,411 S * 5/2005 Sakai D14/192
 D519,108 S * 4/2006 Yang D14/223
 7,120,267 B2 * 10/2006 Ito H04M 1/05
 381/375
 D588,111 S * 3/2009 Komiyama D14/223
 D603,380 S * 11/2009 Hutchieson D14/223
 D637,997 S * 5/2011 Peller D14/205
 D637,999 S * 5/2011 Brunner D14/205
 D641,010 S * 7/2011 Kwon D14/223
 D652,817 S * 1/2012 Lee D14/205
 D652,822 S * 1/2012 Lee D14/223
 D654,056 S * 2/2012 Hoggarth D14/205
 D666,581 S * 9/2012 Perez D14/223
 8,275,166 B2 * 9/2012 Wu H04R 25/00
 381/328
 D699,226 S * 2/2014 Yoon D14/206
 D705,757 S * 5/2014 Yashiro H04R 1/10
 D14/223
 8,776,801 B2 * 7/2014 McIntosh A61F 11/08
 128/864
 D711,356 S * 8/2014 Yang D14/223
 D719,550 S * 12/2014 Yang D14/223
 D725,082 S * 3/2015 Palmborg D14/223
 8,983,108 B2 * 3/2015 Ho H04R 1/1016
 181/135
 D726,145 S * 4/2015 Hsieh D14/205
 D727,871 S * 4/2015 Orbach D14/205
 D733,102 S * 6/2015 Palmborg D14/223
 D733,103 S * 6/2015 Jeong D14/224
 D735,169 S * 7/2015 Shieh D14/223
 9,087,506 B1 * 7/2015 Kraft G10L 21/0232
 9,131,308 B2 * 9/2015 Kraft G10L 21/0232
 D742,861 S * 11/2015 Miyake D14/223

D764,445 S * 8/2016 Czaniecki D14/223
 D773,032 S * 11/2016 Palmborg D24/106
 D777,710 S * 1/2017 Palmborg D14/223
 D778,267 S * 2/2017 Hsieh D14/223
 9,565,491 B2 * 2/2017 Baker H04R 1/1083
 D781,269 S * 3/2017 Choe D14/223
 D782,997 S * 4/2017 Shin D14/205
 D782,998 S * 4/2017 Shin D14/205
 D788,079 S * 5/2017 Son D14/223
 D798,843 S * 10/2017 Valenzuela D14/223
 D800,097 S * 10/2017 Chen D14/223
 D801,951 S * 11/2017 Bao D14/223
 D806,879 S * 1/2018 Horbinski D24/174
 D812,042 S * 3/2018 Xiao D14/223
 D813,206 S * 3/2018 Tang D14/223
 D818,990 S * 5/2018 Tzeng D14/205
 D824,371 S * 7/2018 Loermann D14/223
 10,052,065 B2 * 8/2018 Boesen A61B 5/742
 D836,089 S * 12/2018 Loermann D14/223
 D841,627 S * 2/2019 Wen D14/223
 D845,932 S * 4/2019 Lu D14/223
 D847,126 S * 4/2019 Loermann D14/223
 D852,782 S * 7/2019 Bergman D14/223
 D863,260 S * 10/2019 Zheng D14/223
 D864,167 S * 10/2019 Wu D14/223
 D868,752 S * 12/2019 Zhu D14/223
 D871,376 S * 12/2019 Zhou D14/223
 D873,248 S * 1/2020 Weicheng D14/223
 D879,074 S * 3/2020 Komiya D14/223
 D880,457 S * 4/2020 Zhu D14/223
 2007/0263896 A1 * 11/2007 Chen H04R 1/105
 381/381
 2011/0293130 A1 * 12/2011 Huang H04R 1/1016
 381/380
 2012/0114160 A1 * 5/2012 Lin H04R 1/1091
 381/380

* cited by examiner

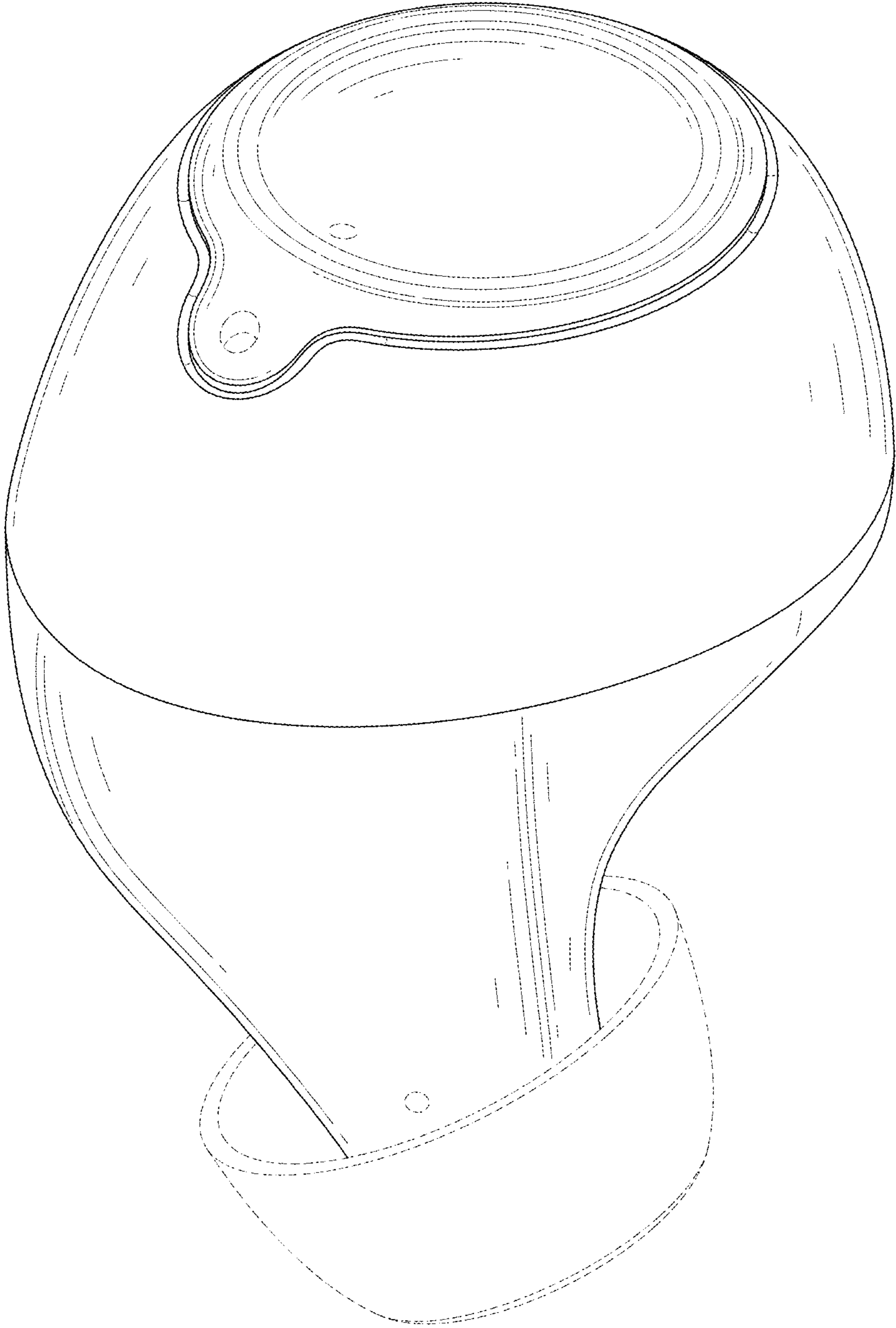

FIG. 1

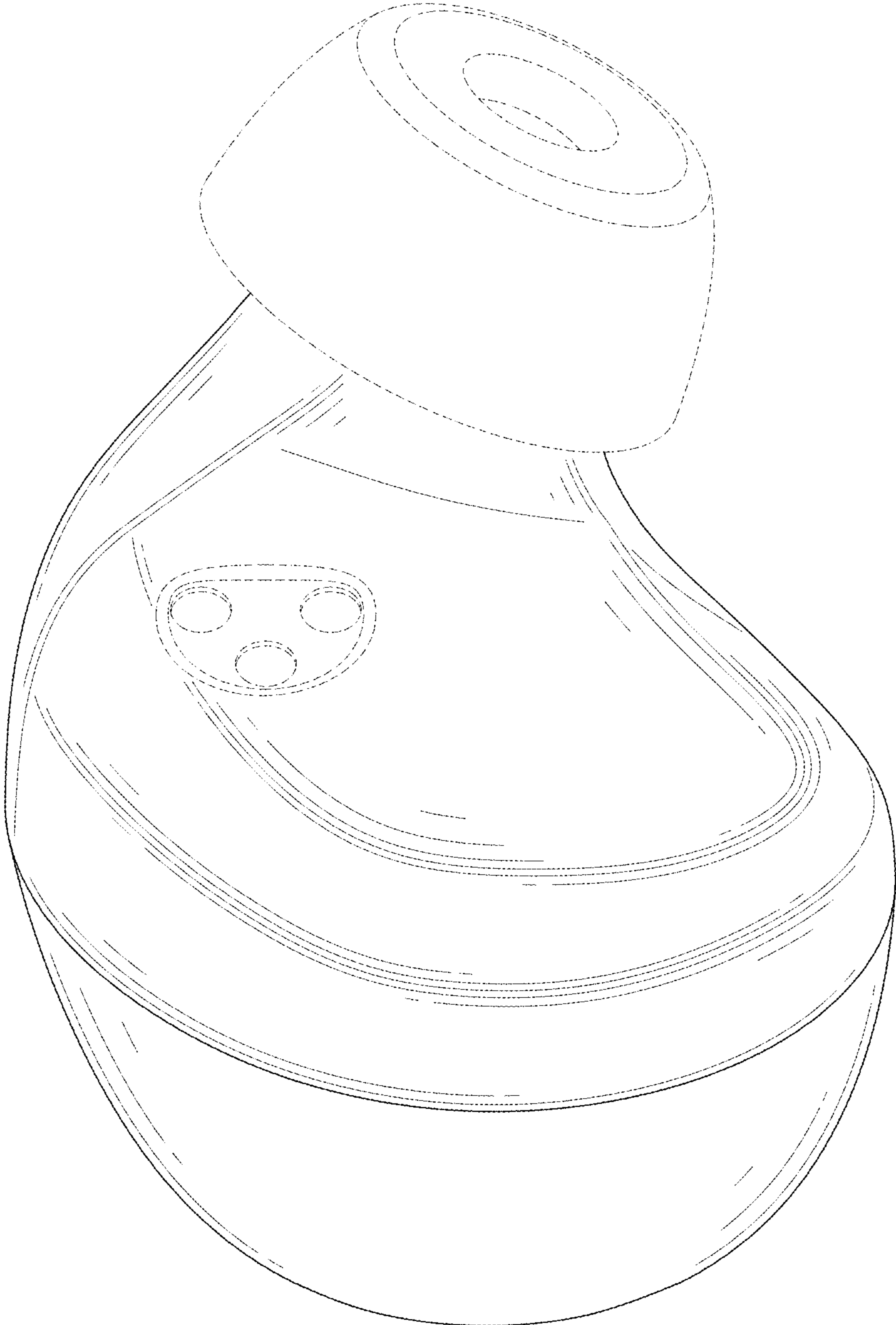

FIG. 2

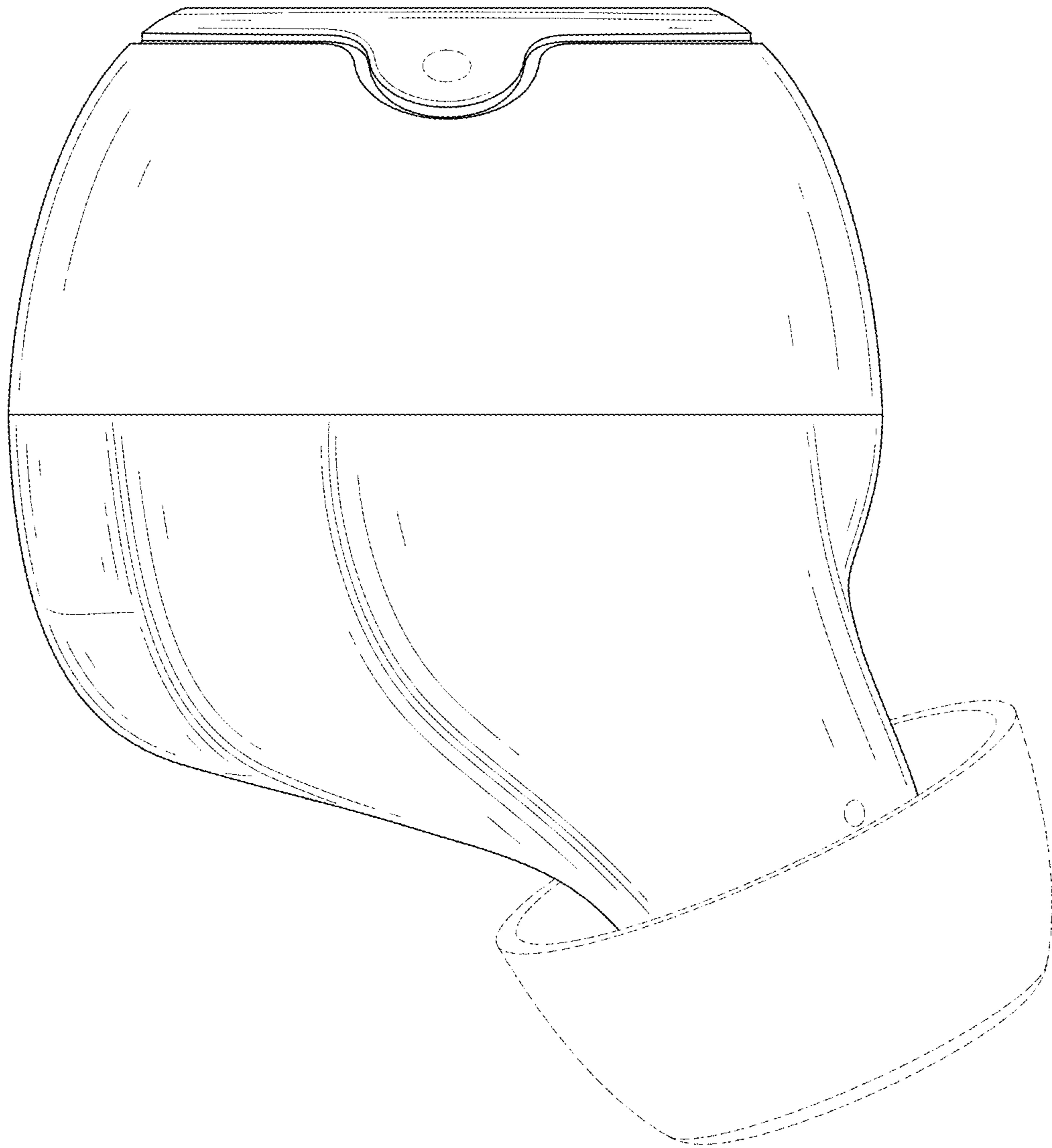

FIG. 3

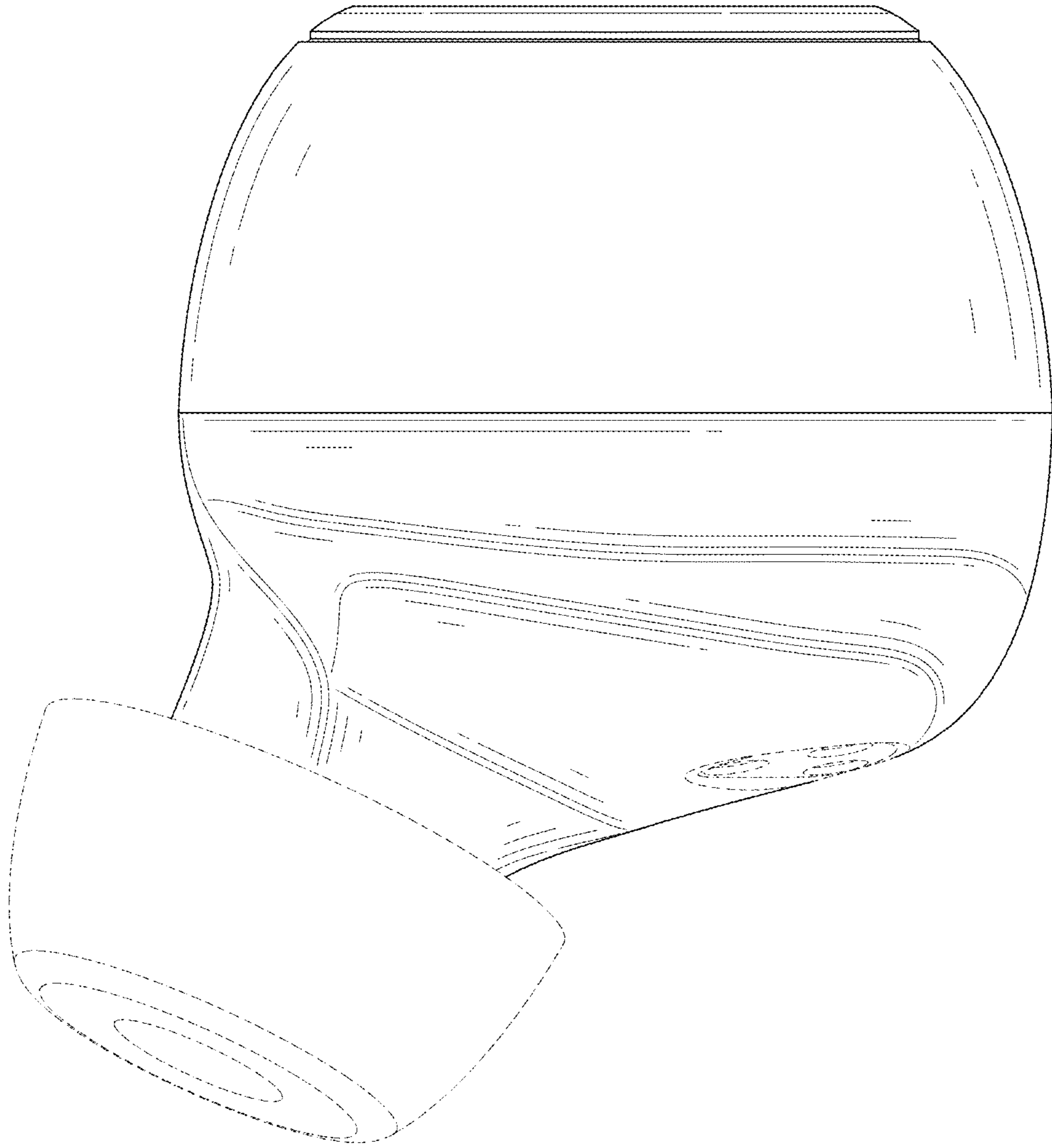

FIG. 4

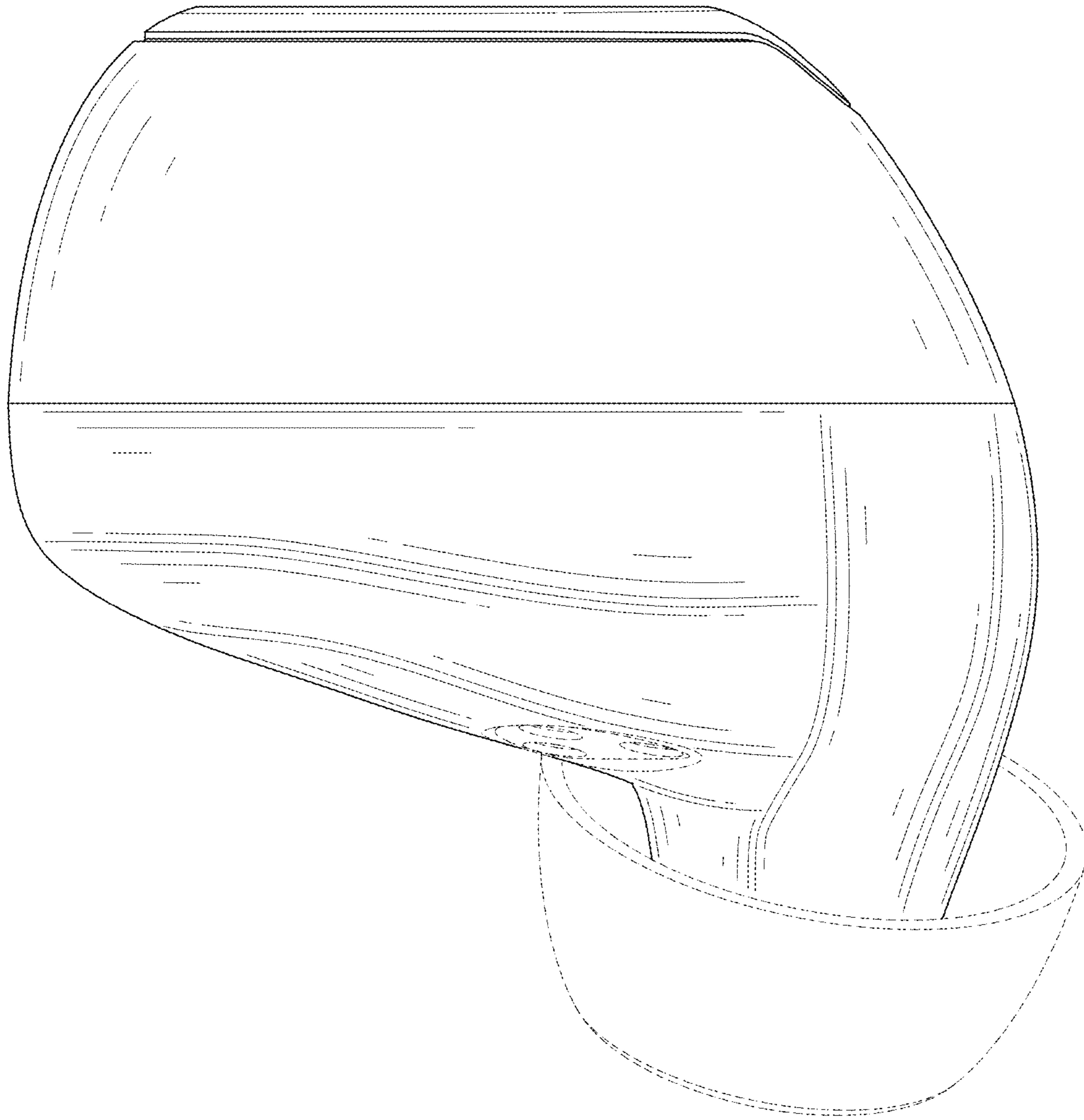

FIG. 5

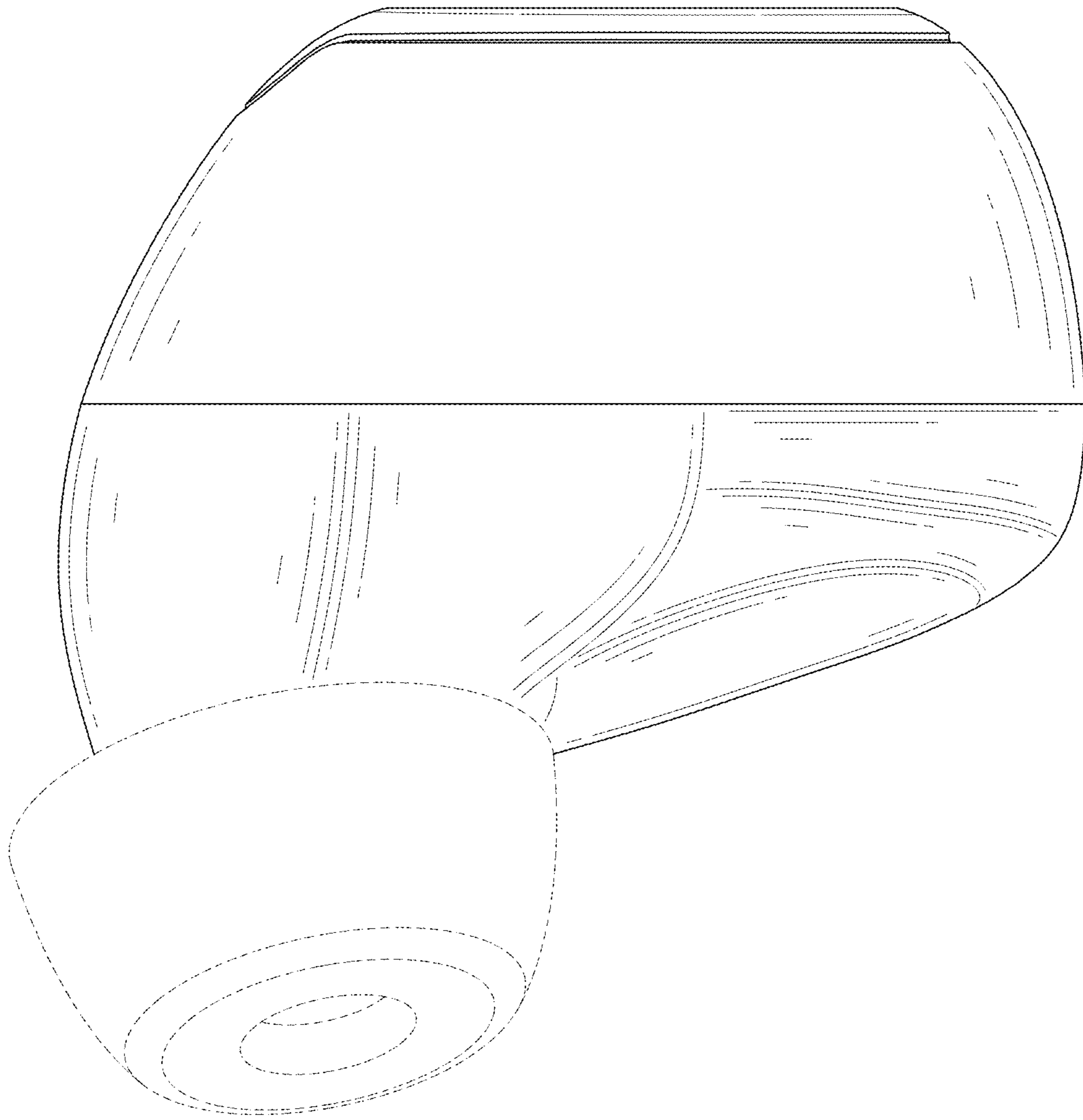

FIG. 6

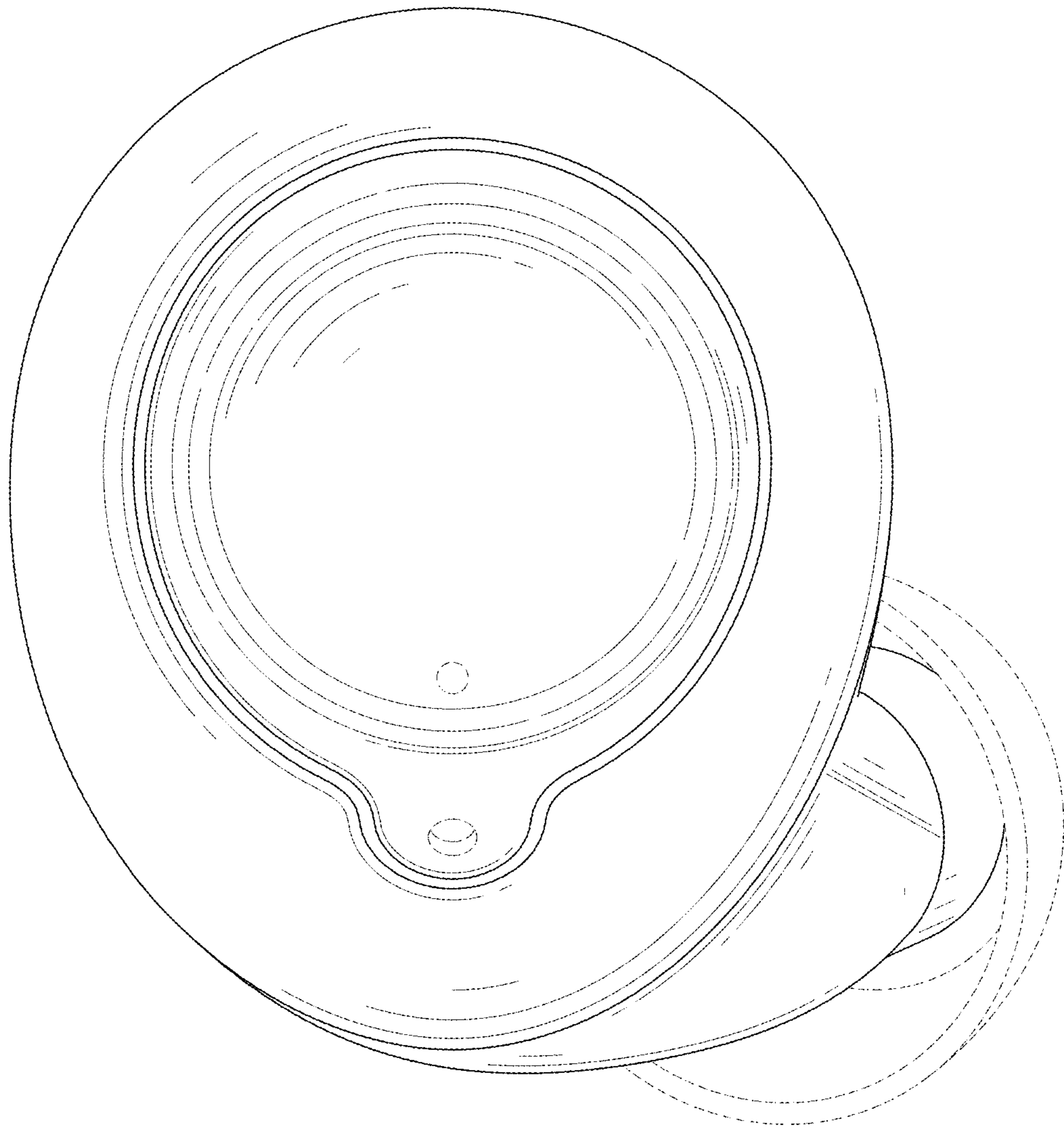

FIG. 7

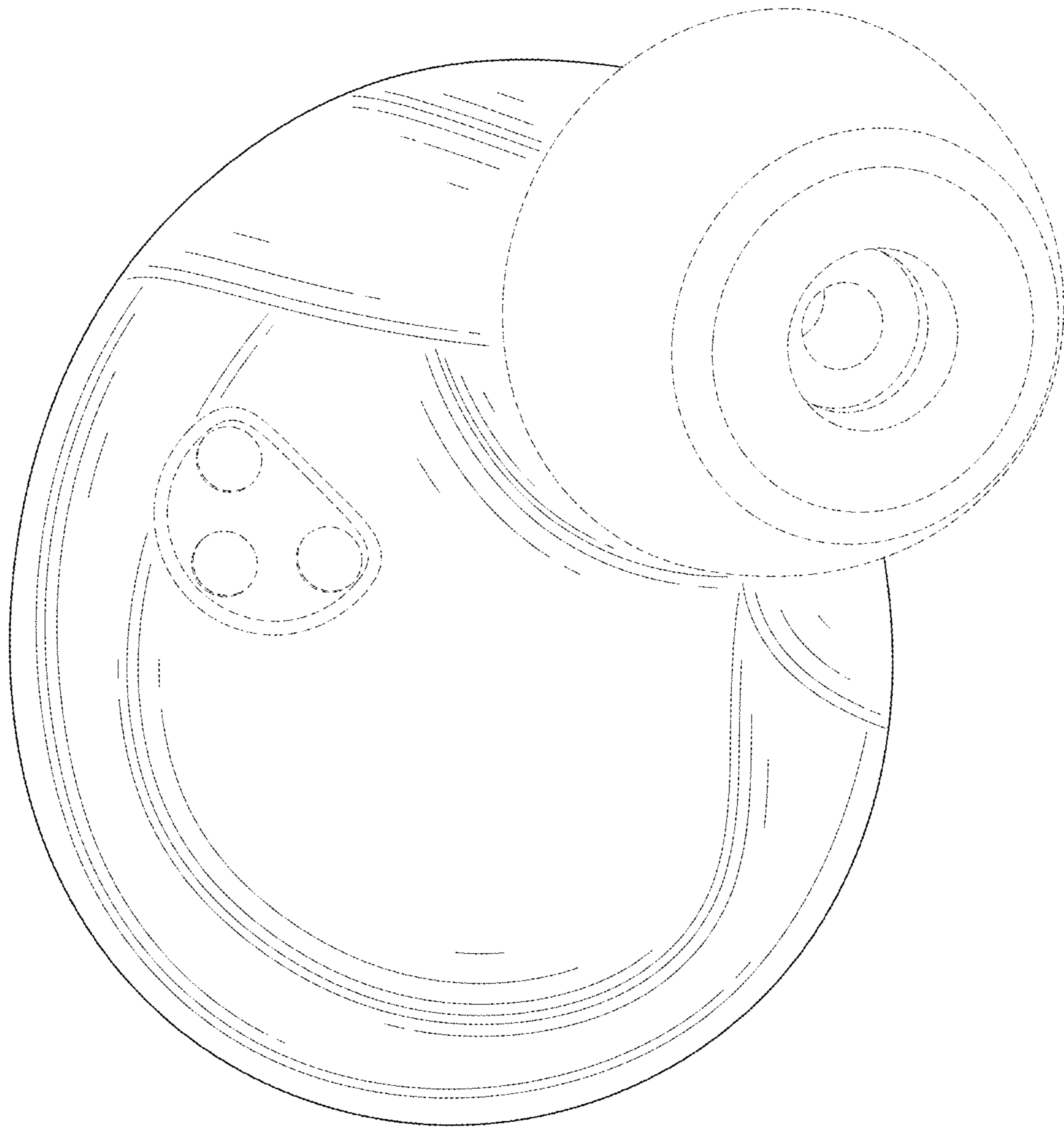

FIG. 8