



US00D887351S

(12) **United States Design Patent** (10) **Patent No.:** **US D887,351 S**
Bonahoom et al. (45) **Date of Patent:** **** Jun. 16, 2020**

(54) **CHARGING CASE FOR WIRELESS
EARPHONES**

(71) Applicant: **SAMSUNG ELECTRONICS CO.,
LTD.**, Suwon-si, Gyeonggi-do (KR)

(72) Inventors: **Rhys Bonahoom**, San Francisco, CA
(US); **Sean Bornheimer**, San Francisco,
CA (US); **Seounghyun Son**, San
Francisco, CA (US); **Rob Shook**, San
Francisco, CA (US)

(73) Assignee: **SAMSUNG ELECTRONICS CO.,
LTD.**, Gyeonggi-Do (KR)

(**) Term: **15 Years**

(21) Appl. No.: **29/679,083**

(22) Filed: **Feb. 1, 2019**

(51) **LOC (12) Cl.** **13-02**

(52) **U.S. Cl.**
USPC **D13/108**

(58) **Field of Classification Search**
USPC D13/103, 107-108, 110, 118, 184, 199;
D14/251, 253, 432, 434; D3/201, 205,
D3/208, 218, 273, 274, 294, 295
CPC .. H02J 7/005; H02J 7/025; H02J 50/00; H02J
50/10; H02J 50/12; H02J 50/40; H02J
50/402; H02J 50/50; H02J 50/80
See application file for complete search history.

(56) **References Cited**

U.S. PATENT DOCUMENTS

D543,935 S * 6/2007 Ke D13/107
D550,210 S * 9/2007 Polany D14/217
D552,029 S * 10/2007 Kingston D13/108
D553,077 S * 10/2007 Kim D13/108
D572,654 S * 7/2008 Kang D13/107
D586,557 S * 2/2009 Jalet D3/294

D738,110 S * 9/2015 Jiang D3/294
D772,572 S * 11/2016 Palmborg D3/201
D806,648 S * 1/2018 Beedham D13/107
D817,640 S * 5/2018 Dang D3/294
D821,970 S * 7/2018 Loermann D13/107
D826,152 S * 8/2018 Christiansen D13/108
D838,480 S * 1/2019 Son D3/294
D841,580 S * 2/2019 Bao D13/108
D841,581 S * 2/2019 Bonahoom D13/108
D846,264 S * 4/2019 Wu D3/201
D849,401 S * 5/2019 Akana D3/274
D851,035 S * 6/2019 Hong D13/108
D851,913 S * 6/2019 Yu D3/201
D864,110 S * 10/2019 Yoshimura D13/108
D873,217 S * 1/2020 Zhang D13/108
2019/0069066 A1 * 2/2019 Song H04R 1/1016

* cited by examiner

Primary Examiner — Rosemary K Tarcza

(74) *Attorney, Agent, or Firm* — Cantor Colburn LLP

(57) **CLAIM**

We claim the ornamental design for a charging case for wireless earphones, as shown and described.

DESCRIPTION

FIG. 1 is a front perspective view of a charging case for wireless earphones, showing our new design;
FIG. 2 is a front view thereof;
FIG. 3 is a rear view thereof;
FIG. 4 is a left-side view thereof;
FIG. 5 is a right-side view thereof;
FIG. 6 is a top view thereof;
FIG. 7 is a bottom view thereof; and,
FIG. 8 is another top view thereof showing an example state of use.

The broken lines in the figures depict portions of the charging case for wireless earphones that form no part of the claimed design.

1 Claim, 5 Drawing Sheets

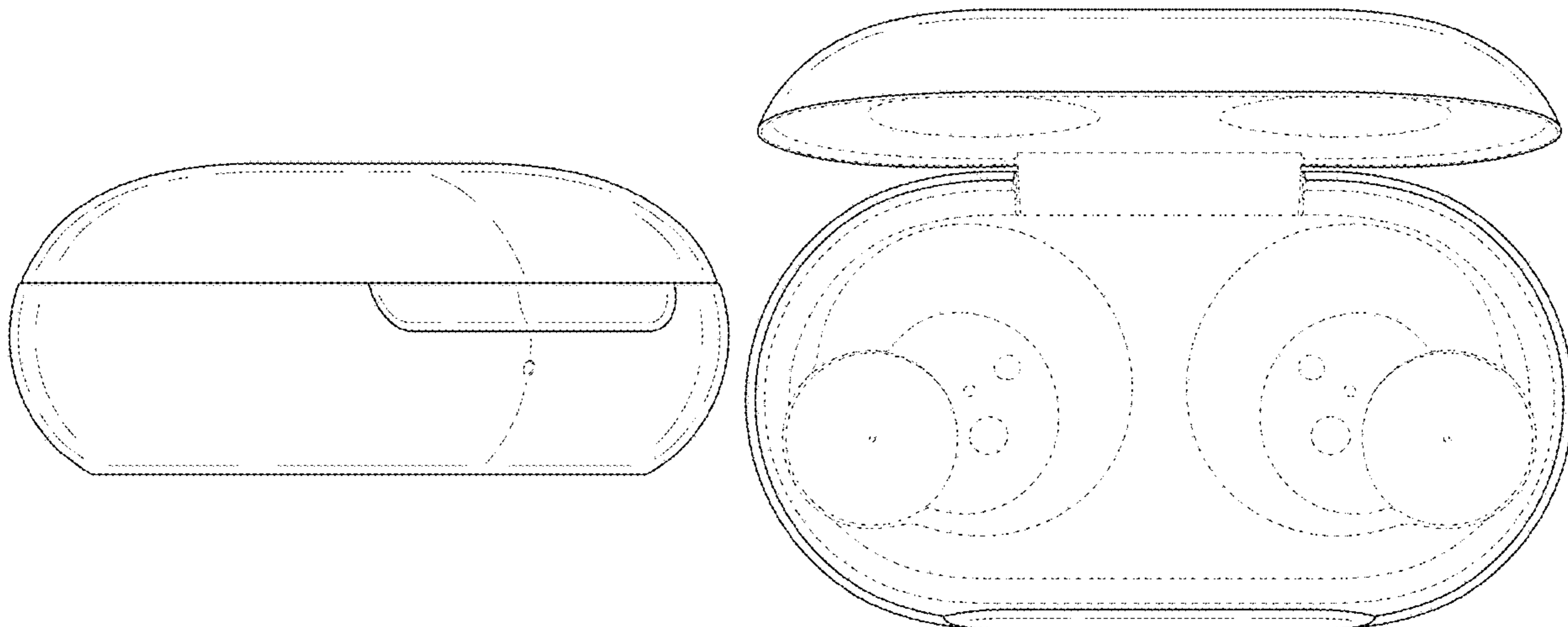

FIG.1

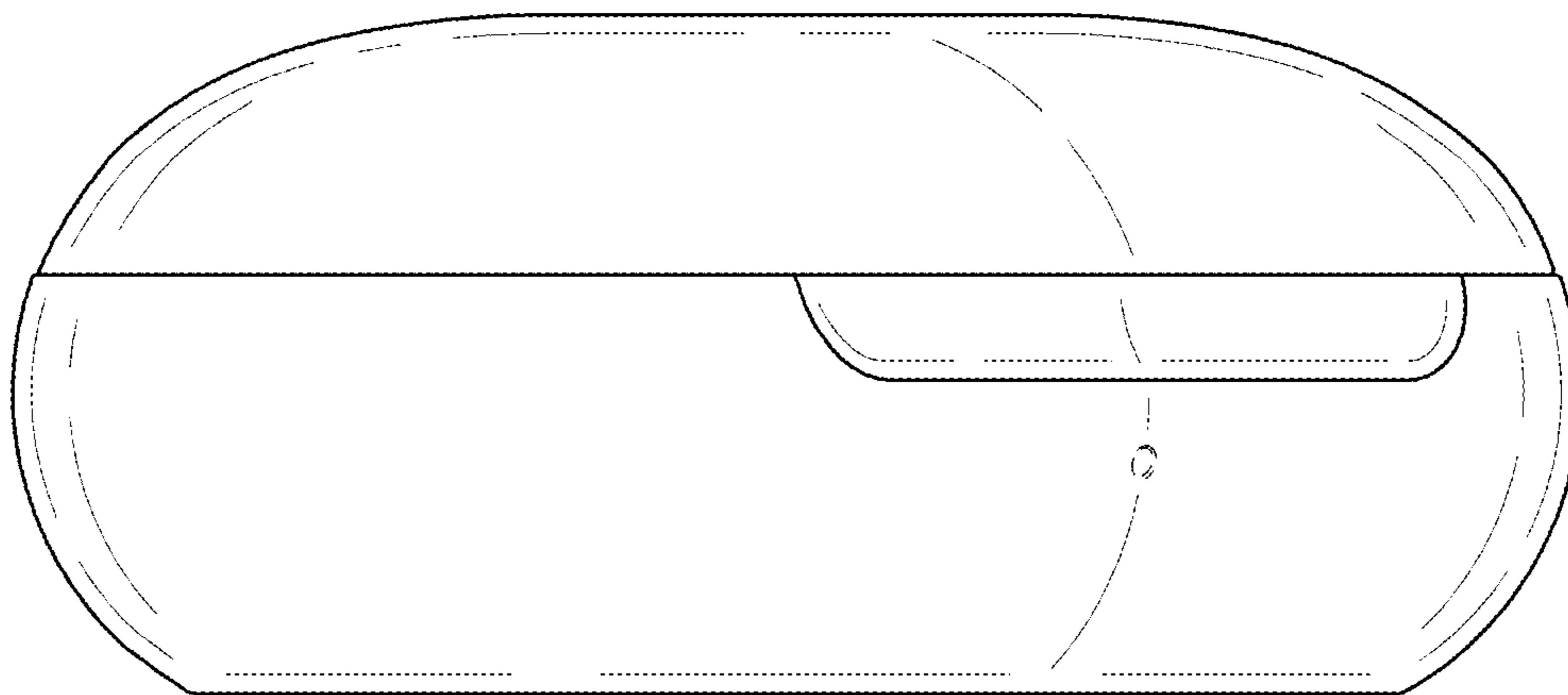

FIG.2

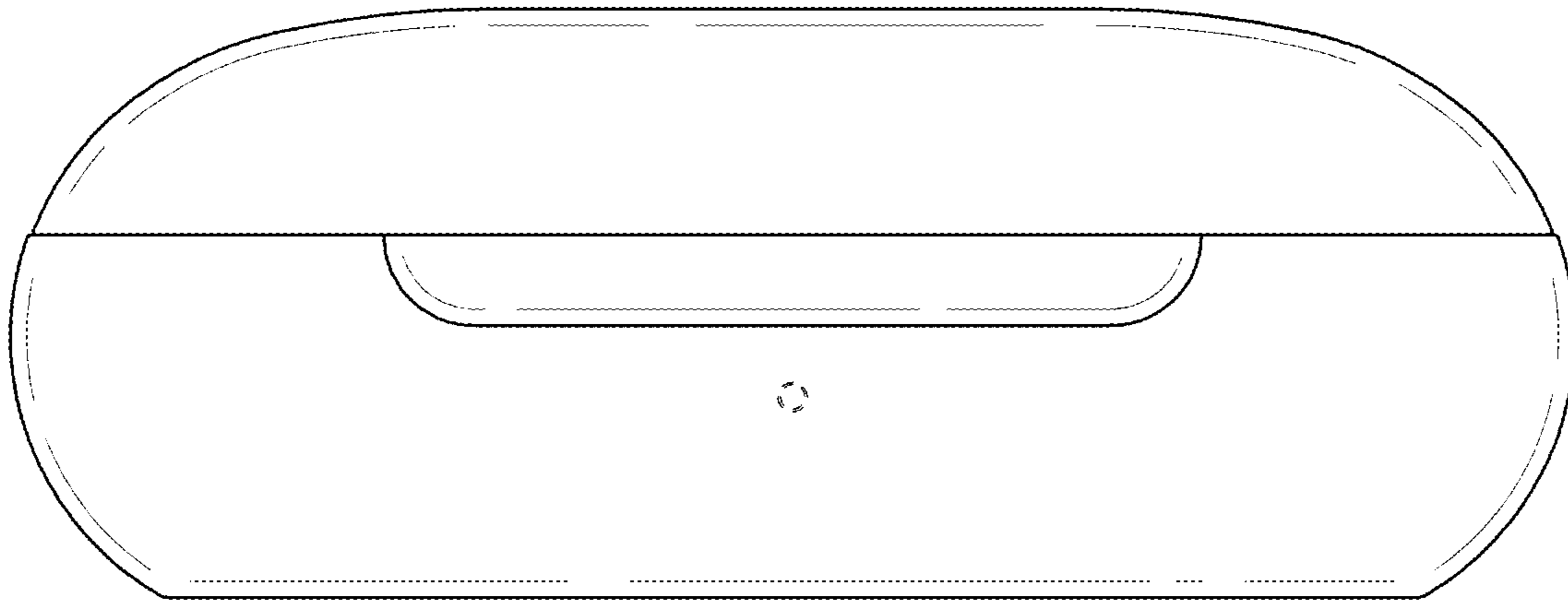

FIG.3

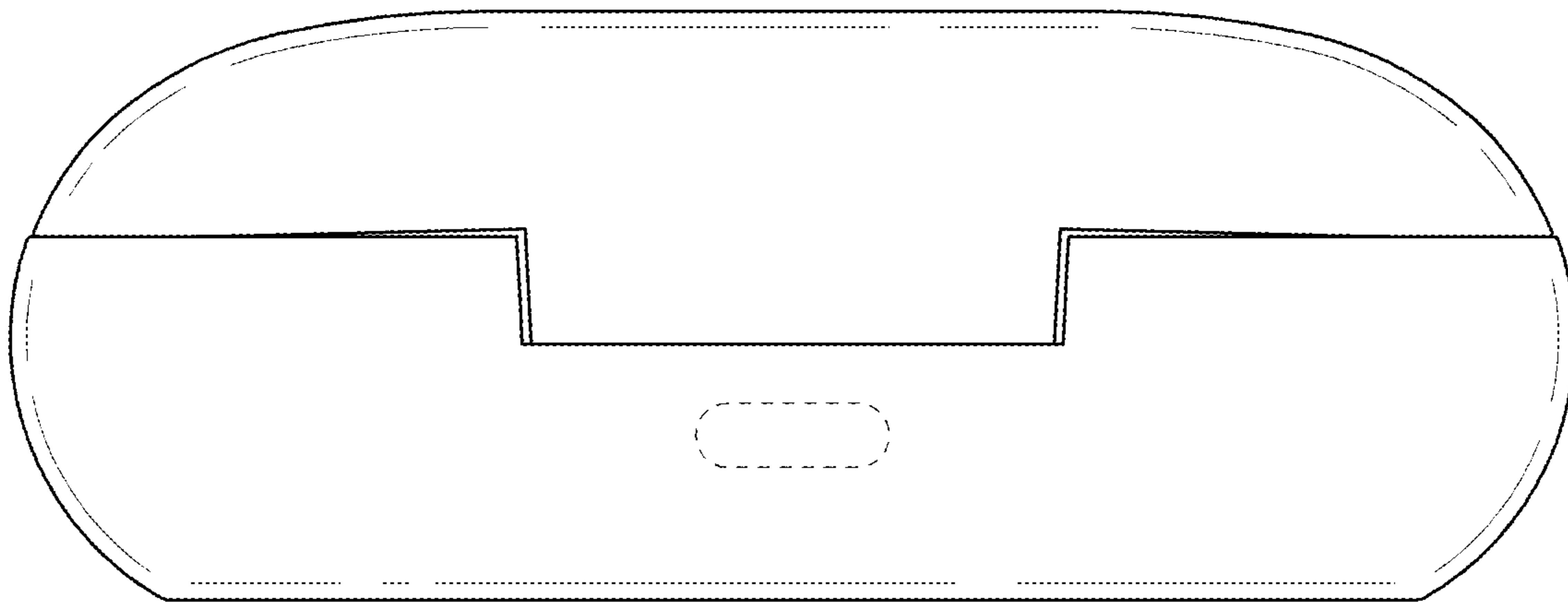

FIG.4

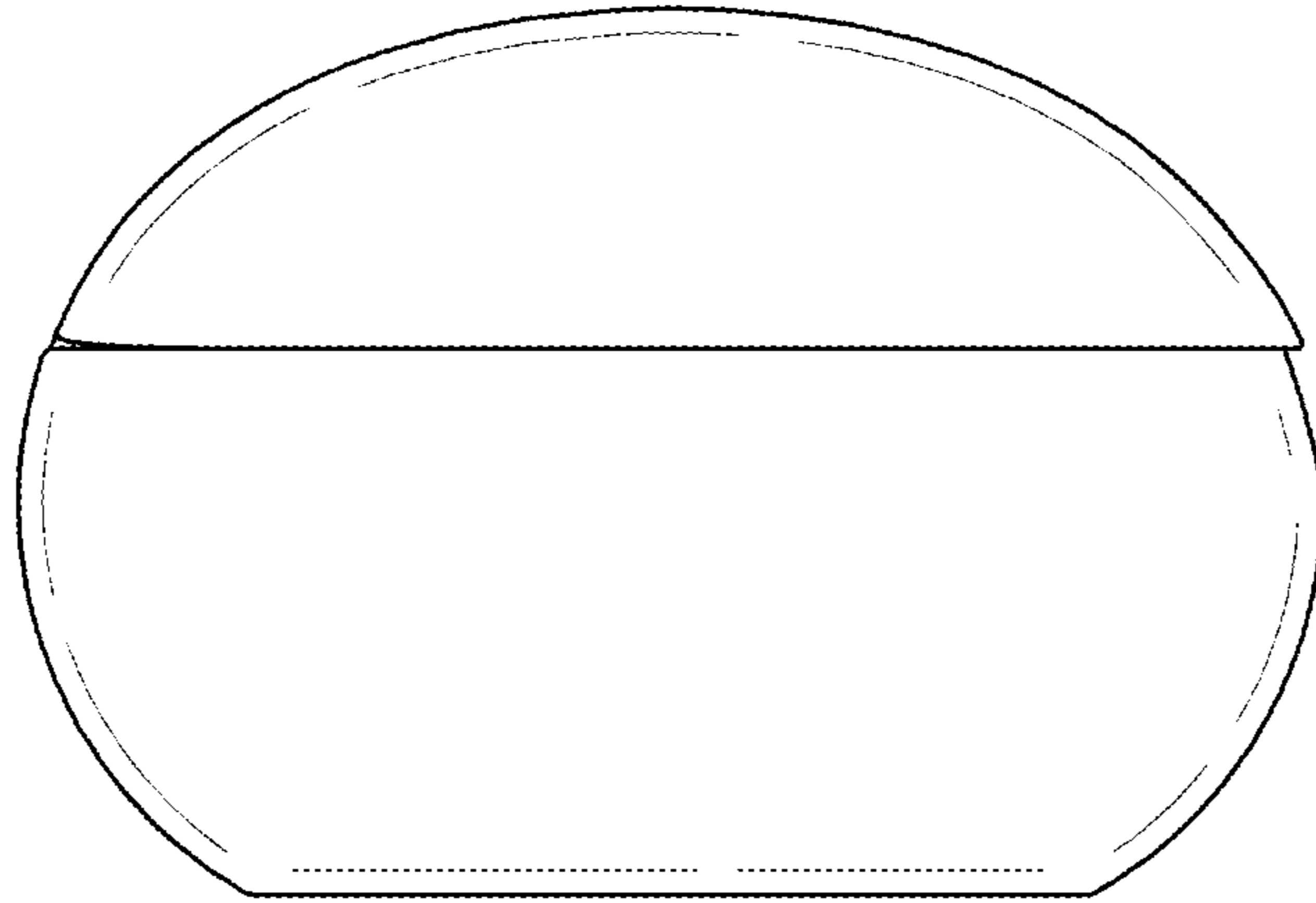

FIG.5

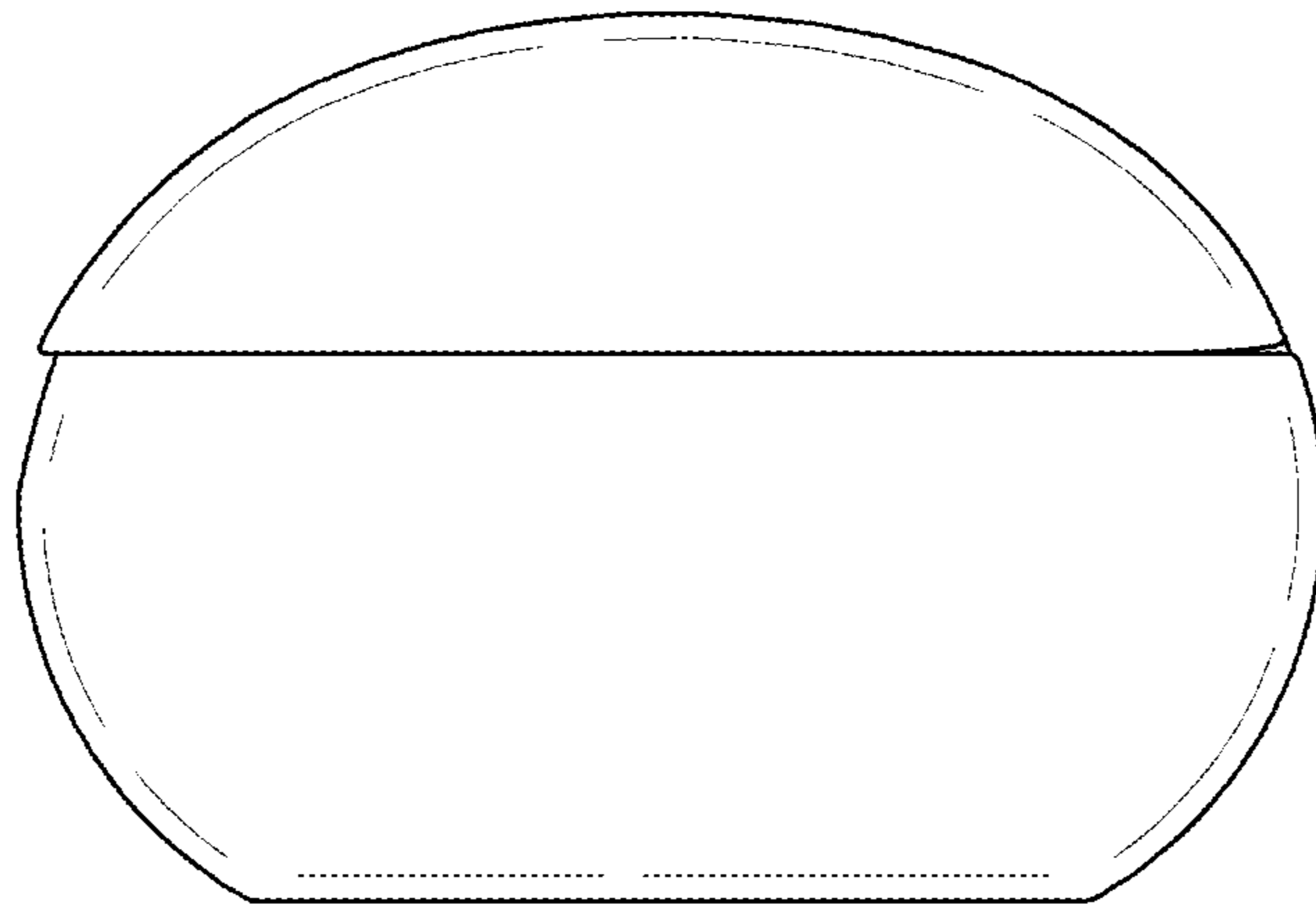

FIG.6

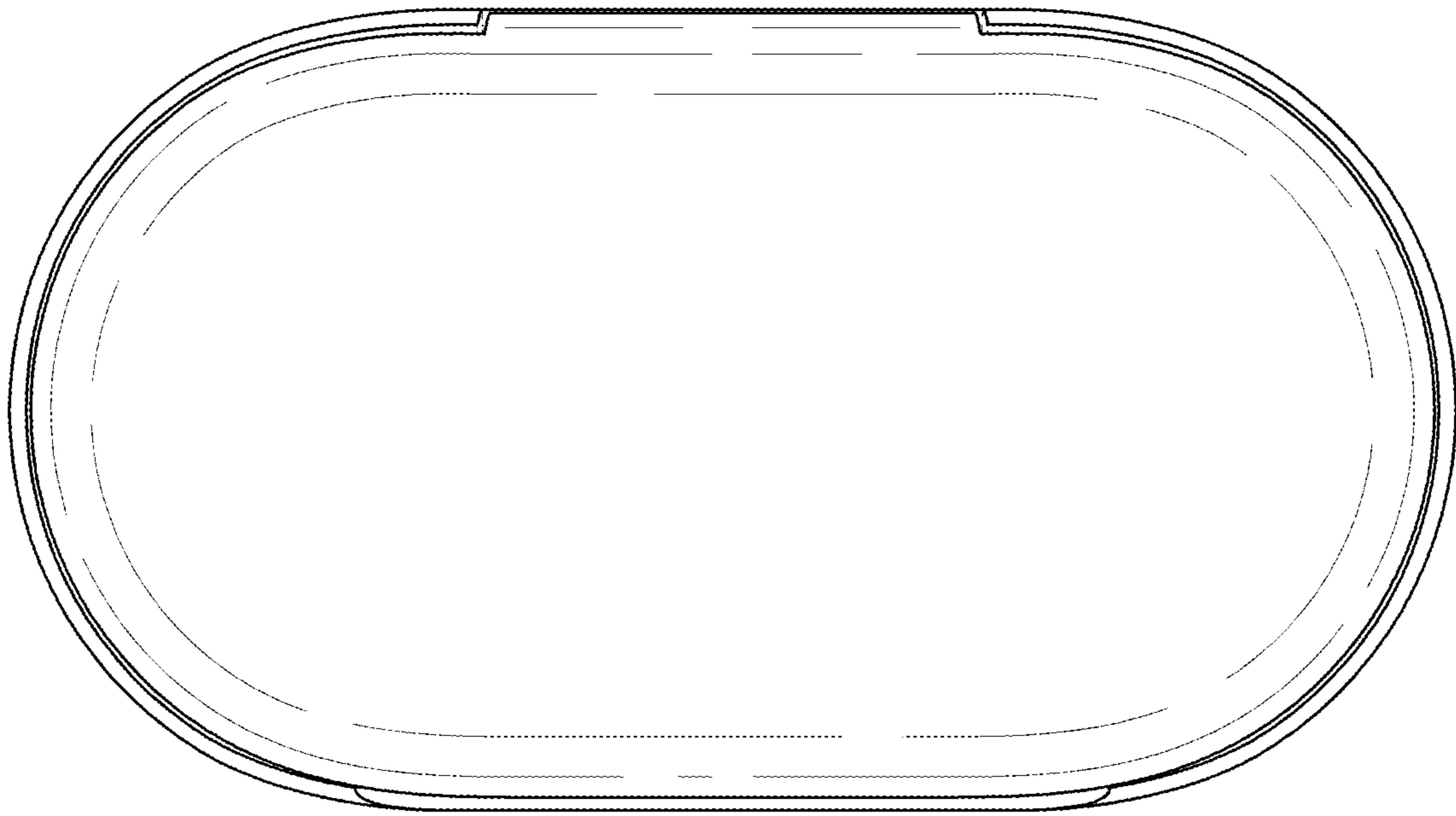

FIG.7

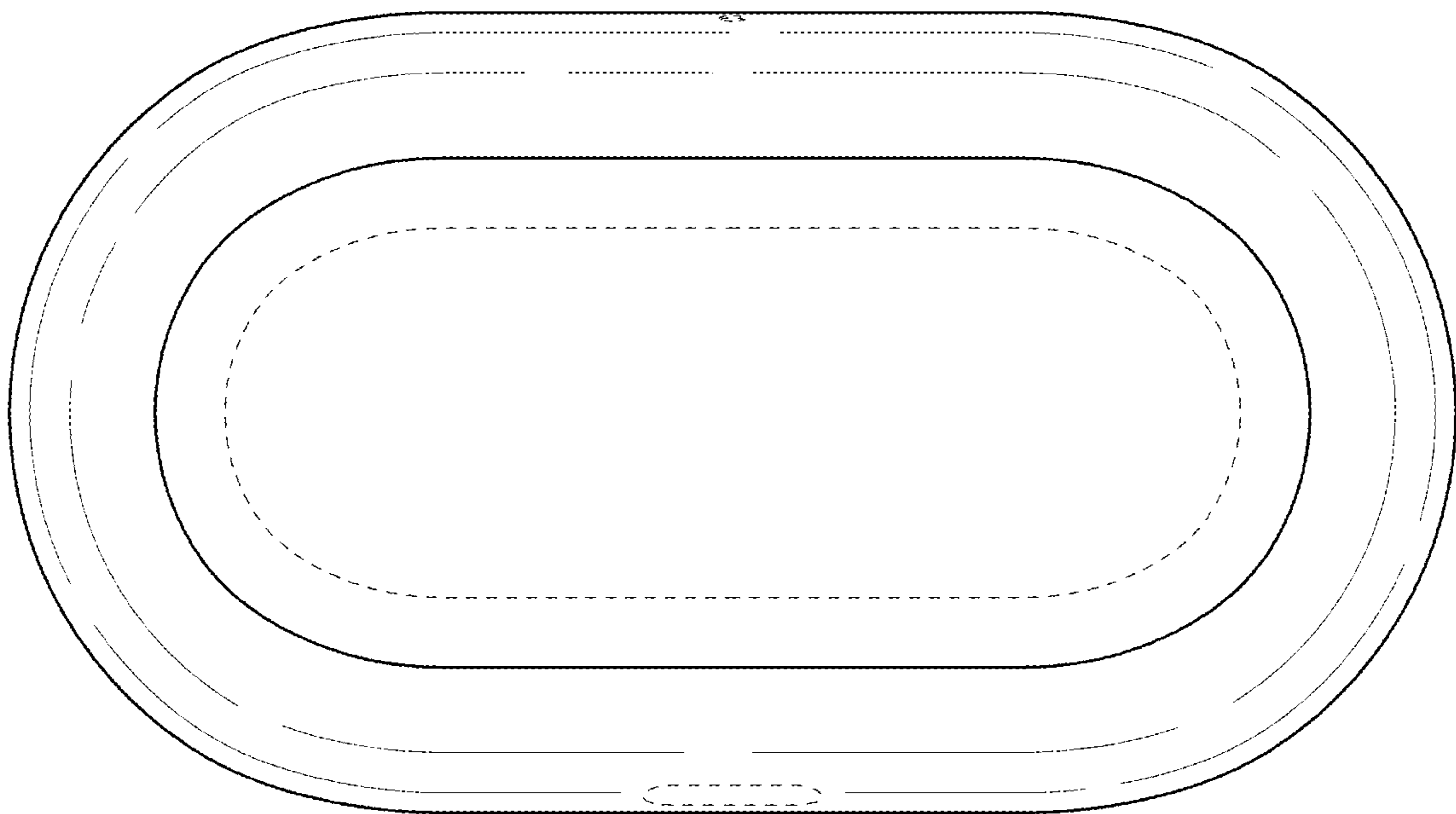

FIG.8

