



US00D887312S

(12) **United States Design Patent**
Tvedt

(10) **Patent No.:** **US D887,312 S**
(45) **Date of Patent:** **** Jun. 16, 2020**

(54) **SIBLING BOARD FOR A BABY CARRIAGE**

(71) Applicant: **Stokke AS, Ålesund (NO)**

(72) Inventor: **Gunnar Eidsvik Tvedt, Oslo (NO)**

(73) Assignee: **Stokke AS, Ålesund (NO)**

(**) Term: **15 Years**

(21) Appl. No.: **29/648,284**

(22) Filed: **May 18, 2018**

(30) **Foreign Application Priority Data**

Nov. 21, 2017 (EM) 004515344-0001

(51) **LOC (12) Cl.** **12-12**

(52) **U.S. Cl.**
USPC **D12/133**

(58) **Field of Classification Search**
USPC D12/128-133
CPC B62B 7/00-04; B62B 9/00-28
See application file for complete search history.

(56) **References Cited**

U.S. PATENT DOCUMENTS

D426,177 S * 6/2000 Lundh D12/133
D426,793 S * 6/2000 Lundh D12/133
D428,367 S * 7/2000 Lundh D12/133

6,851,693 B2 * 2/2005 Haeggberg B62B 9/28
280/204
7,641,217 B2 * 1/2010 Yoo A61G 5/08
180/208
7,971,884 B2 * 7/2011 Lundh B62B 9/28
280/32.7
8,029,007 B2 * 10/2011 Jones B62D 63/00
280/204
D682,749 S * 5/2013 Lai D12/133
D769,776 S * 10/2016 Barenbrug D12/133
D823,176 S * 7/2018 Baxla D12/133
D826,105 S * 8/2018 Chaudeurge D12/133

* cited by examiner

Primary Examiner — Charles D Hanson

(74) *Attorney, Agent, or Firm* — Kolisch Hartwell, P.C.

(57) **CLAIM**

The ornamental design for a sibling board for a baby carriage, as shown.

DESCRIPTION

FIG. 1 is an upper, right side, and rear perspective view of a sibling board for a baby carriage showing the new design; FIG. 2 is a right side elevation view thereof; FIG. 3 is a left side elevation view; FIG. 4 is a top plan view thereof; FIG. 5 is a bottom plan view thereof; FIG. 6 is a front elevation view thereof; and, FIG. 7 is a rear elevation view thereof.

1 Claim, 4 Drawing Sheets

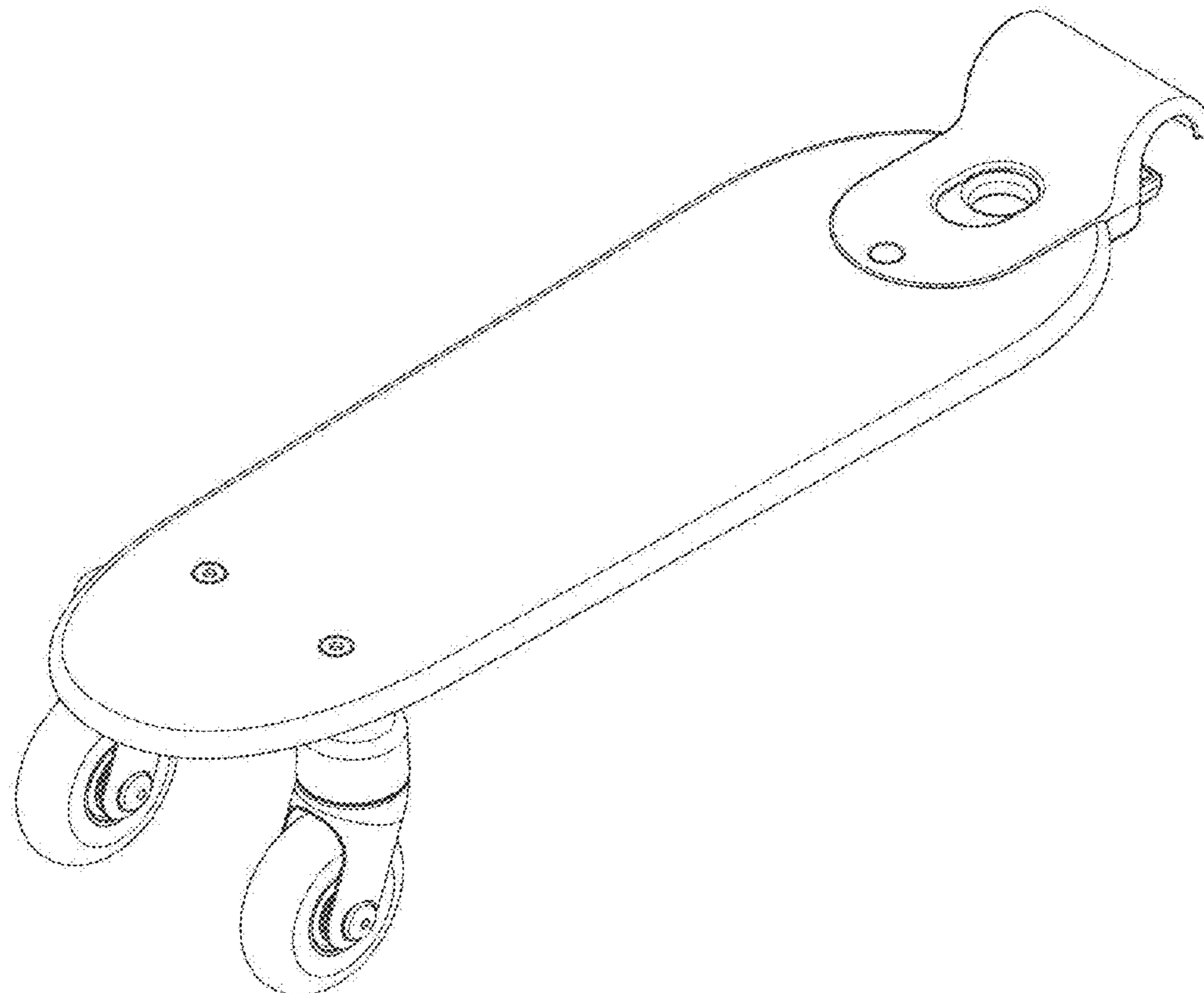

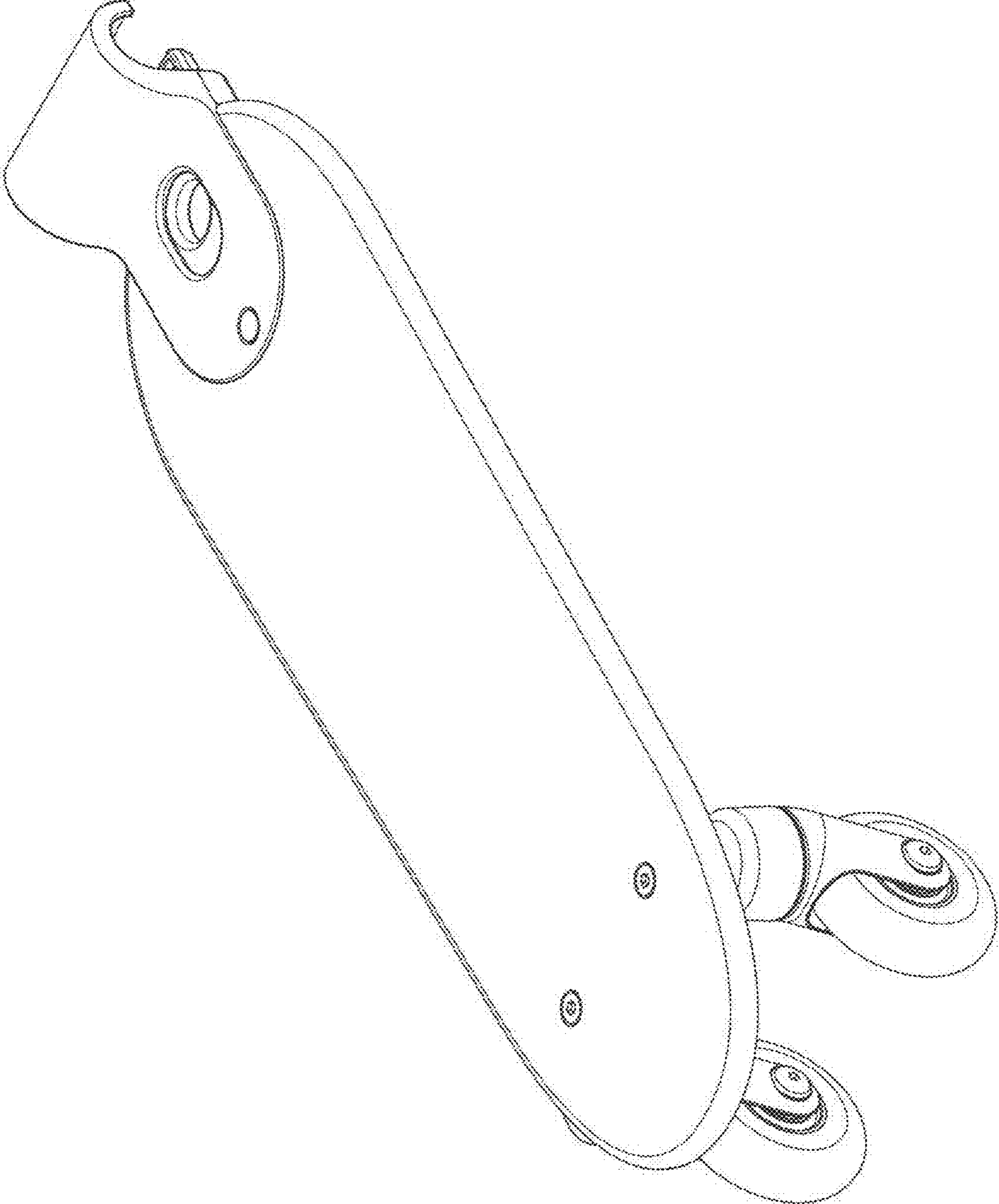

Fig. 1

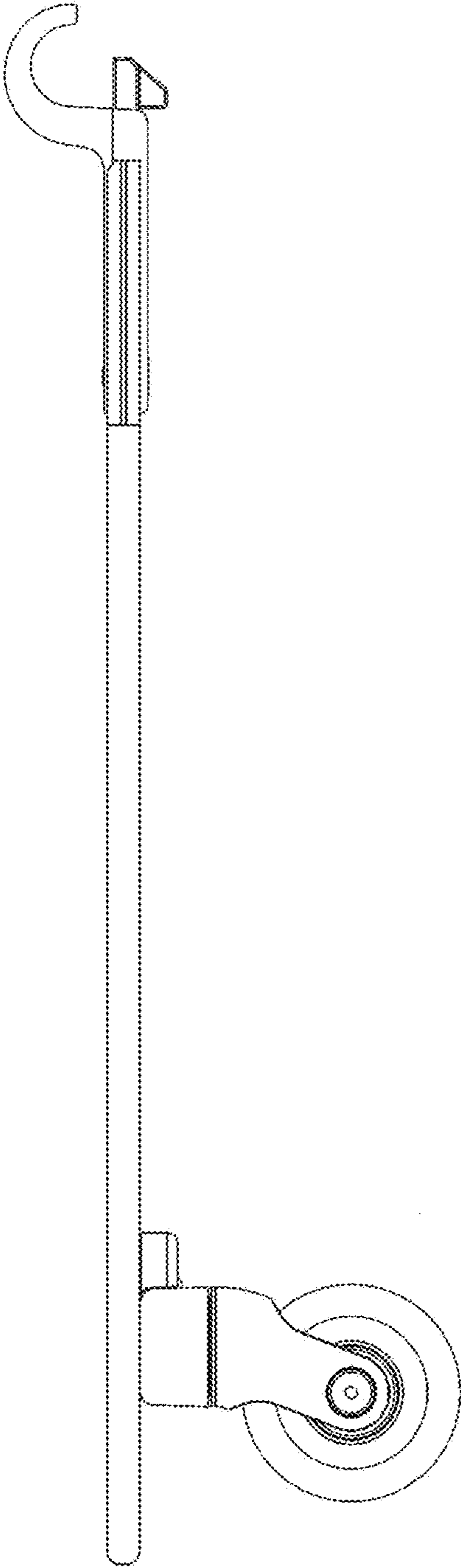

Fig. 2

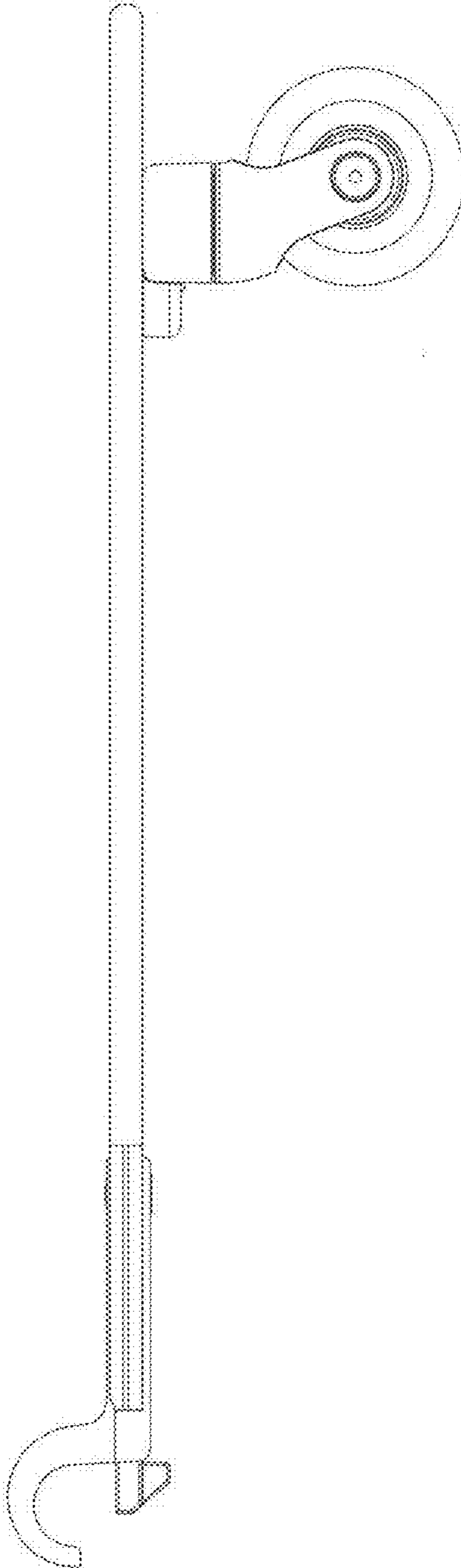

Fig. 3

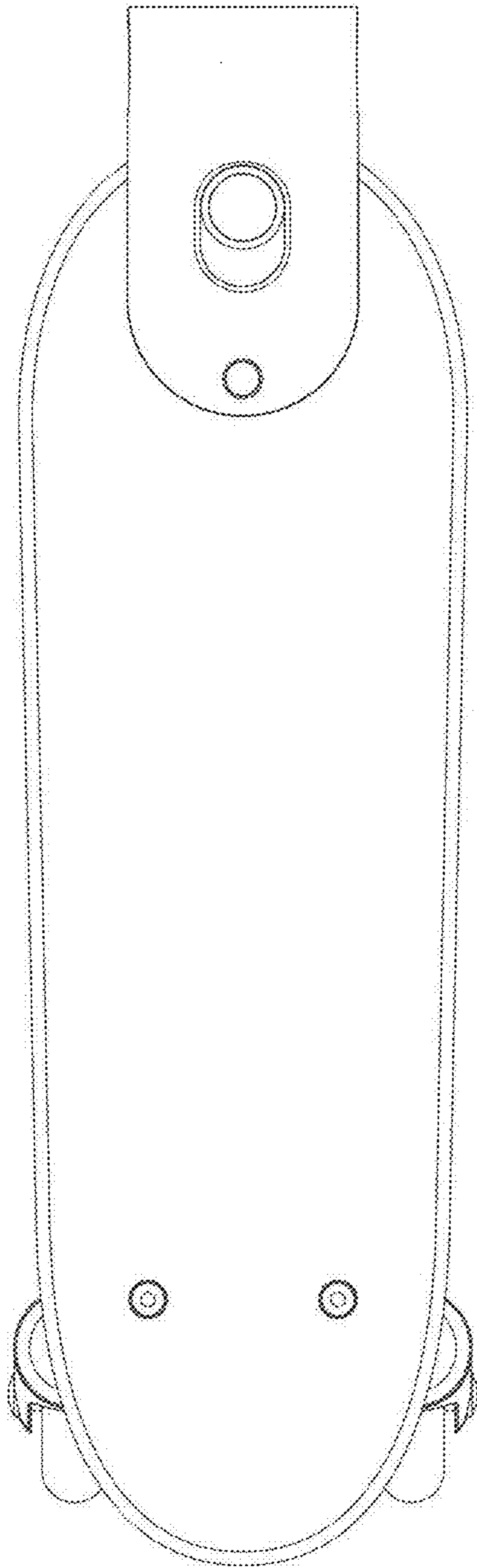

Fig. 4

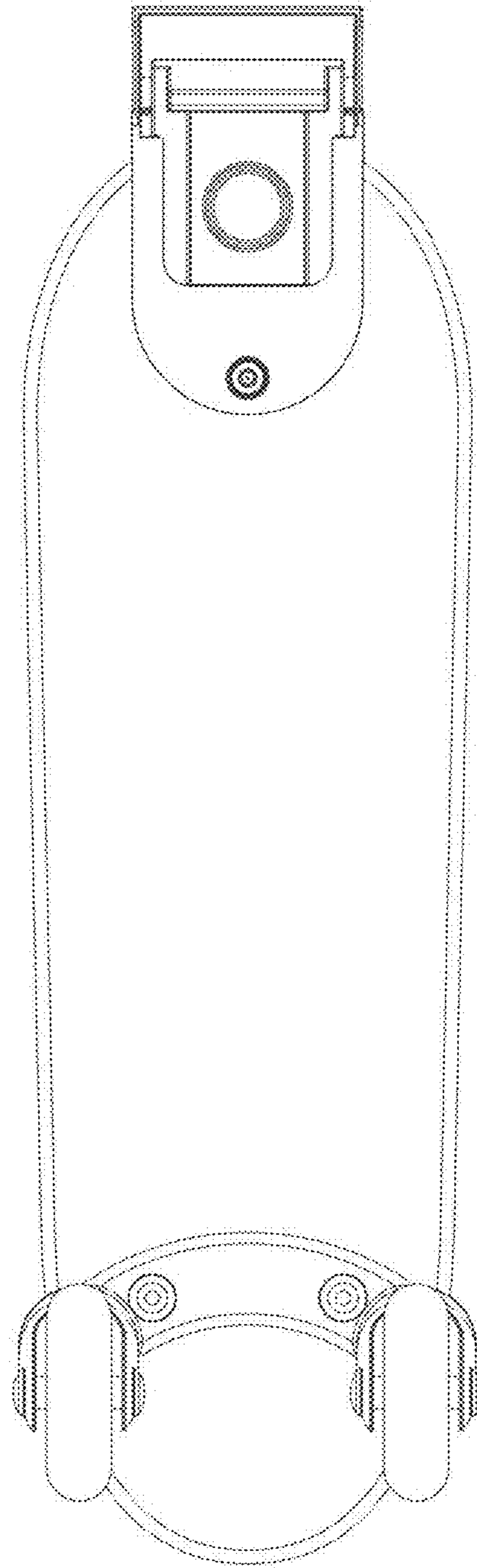

Fig. 5

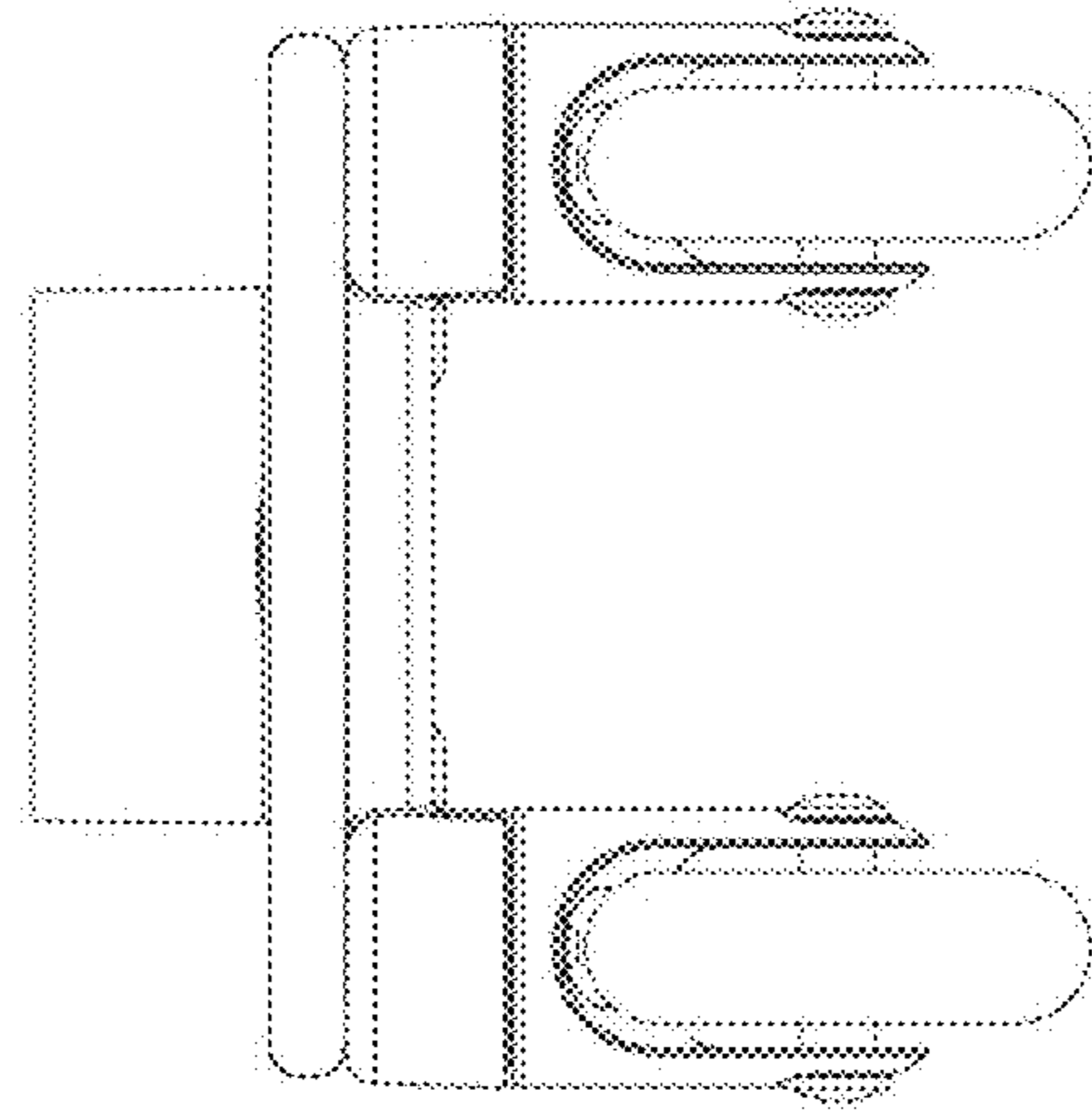

Fig. 6

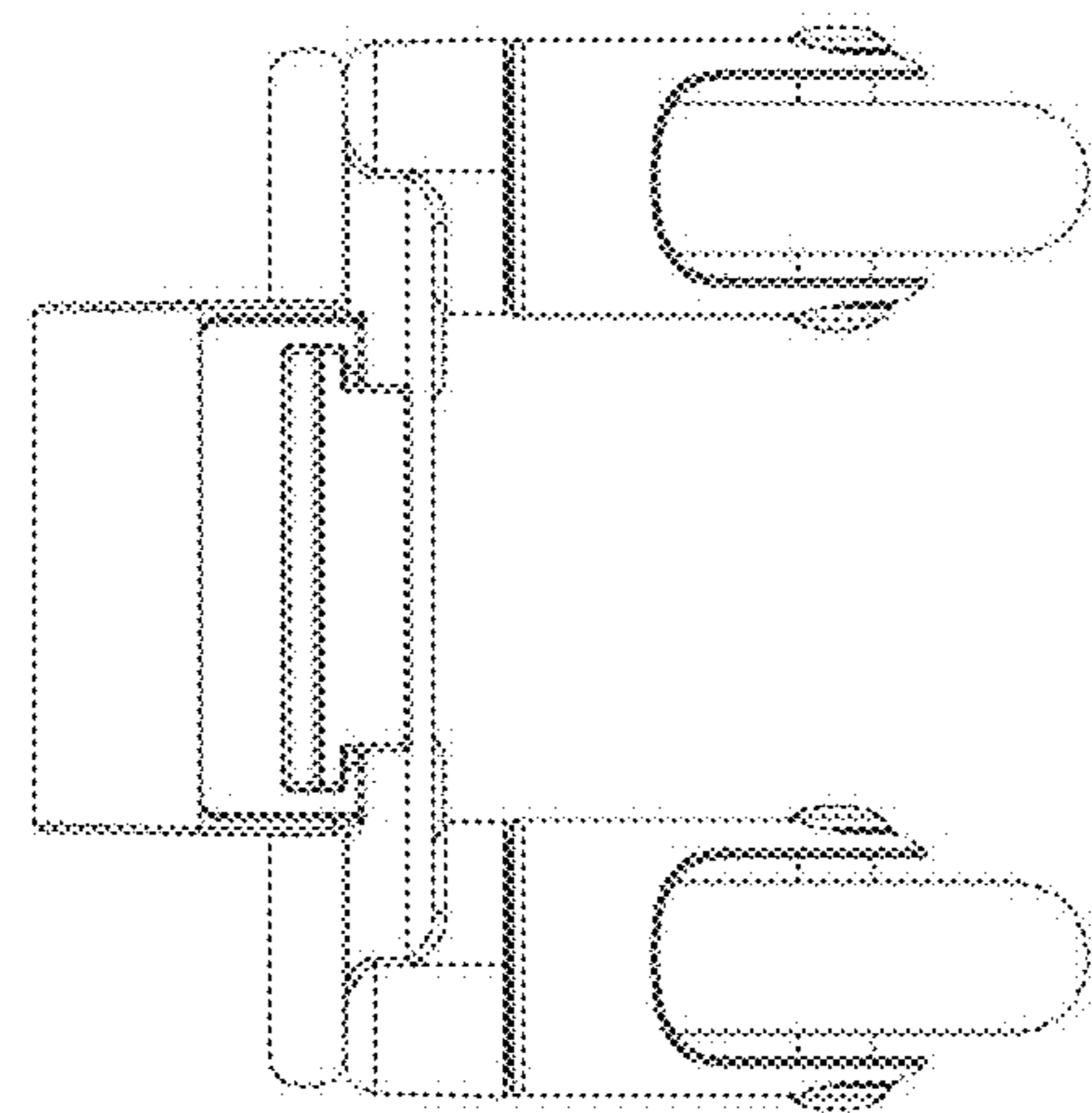

Fig. 7