



US00D887156S

(12) **United States Design Patent** (10) **Patent No.:** **US D887,156 S**
Wesline (45) **Date of Patent:** **** Jun. 16, 2020**

(54) **VEHICLE SEAT**
(71) Applicant: **Milsco, LLC**, Milwaukee, WI (US)
(72) Inventor: **Scott M. Wesline**, Menomonee Falls, WI (US)
(73) Assignee: **MILSCO, LLC**, Milwaukee, WI (US)
(**) Term: **15 Years**

D482,882 S * 12/2003 Murphy D6/356
D516,824 S * 3/2006 Murphy D6/356
D536,187 S * 2/2007 Goebert D6/356
D536,546 S * 2/2007 Goebert D6/356
D536,547 S * 2/2007 Goebert D6/356
D536,887 S * 2/2007 Goebert D6/356
7,722,068 B2 * 5/2010 Michelau B62K 9/02
280/220
D646,086 S * 10/2011 Hickman D6/375
(Continued)

(21) Appl. No.: **29/671,729**
(22) Filed: **Nov. 29, 2018**
(51) **LOC (12) Cl.** **06-01**
(52) **U.S. Cl.**
USPC **D6/356**
(58) **Field of Classification Search**
USPC D6/339, 353, 356, 368, 601, 655, 716.1,
D6/716.2, 716.3, 716.4, 716.5, 716.6,
D6/716.7
CPC .. A47C 3/04; A47C 3/16; A47C 7/021; A47C
7/407; A47C 17/1655; A47K 3/122;
B60N 2/02; B60N 2/20; B60N 2/22;
B60N 2/32; B60N 2/38; B60N 2/3002;
B60N 2/3004; B60N 2/3011; B60N
2/3065; B60N 2/3097; B63B 2709/00;
B63B 29/04; B63B 2029/043; Y10S
297/02
See application file for complete search history.

(56) **References Cited**
U.S. PATENT DOCUMENTS
D237,330 S * 10/1975 Skyer et al. D6/356
D244,645 S * 6/1977 Talmon D6/356
4,045,080 A * 8/1977 Barecki B60N 2/242
297/283.2
D249,102 S * 8/1978 Pelly D6/334
D289,706 S * 5/1987 Talmon D6/356
5,876,085 A * 3/1999 Hill B60N 2/502
296/65.02
D482,881 S * 12/2003 Murphy D6/356

OTHER PUBLICATIONS

“A&I Products Seat, BLK Parts. Replacement for John Deere Part No. GY20063” Aug. 14, 2013, amazon.com, site visited Dec. 4, 2019 <<https://www.amazon.com/Products-Parts-Replacement-Number-GY20063/dp/B00BW6DNM8#customerReviews>> (Year: 2013).*

Primary Examiner — Kevin K Rudzinski
Assistant Examiner — Paul D Bohannon
(74) *Attorney, Agent, or Firm* — Boyle Fredrickson S.C.

(57) **CLAIM**

The ornamental design for a vehicle seat, as shown and described.

DESCRIPTION

FIG. 1 is a perspective view of a vehicle seat incorporating my new design, viewed from in front of, above, and from the left side thereof;
FIG. 2 is a front elevation view thereof;
FIG. 3 is a rear elevation view thereof;
FIG. 4 is a right side elevation view thereof;
FIG. 5 is a left side elevation view thereof;
FIG. 6 is a top plan view thereof; and,
FIG. 7 is a bottom plan view thereof.
The broken lines in FIGS. 1-7 form no part of the claimed design and include dot-dashed lines that define the bounds of the claimed design and dashed lines that illustrate portions of the vehicle seat that form no part of the claimed design.

1 Claim, 7 Drawing Sheets

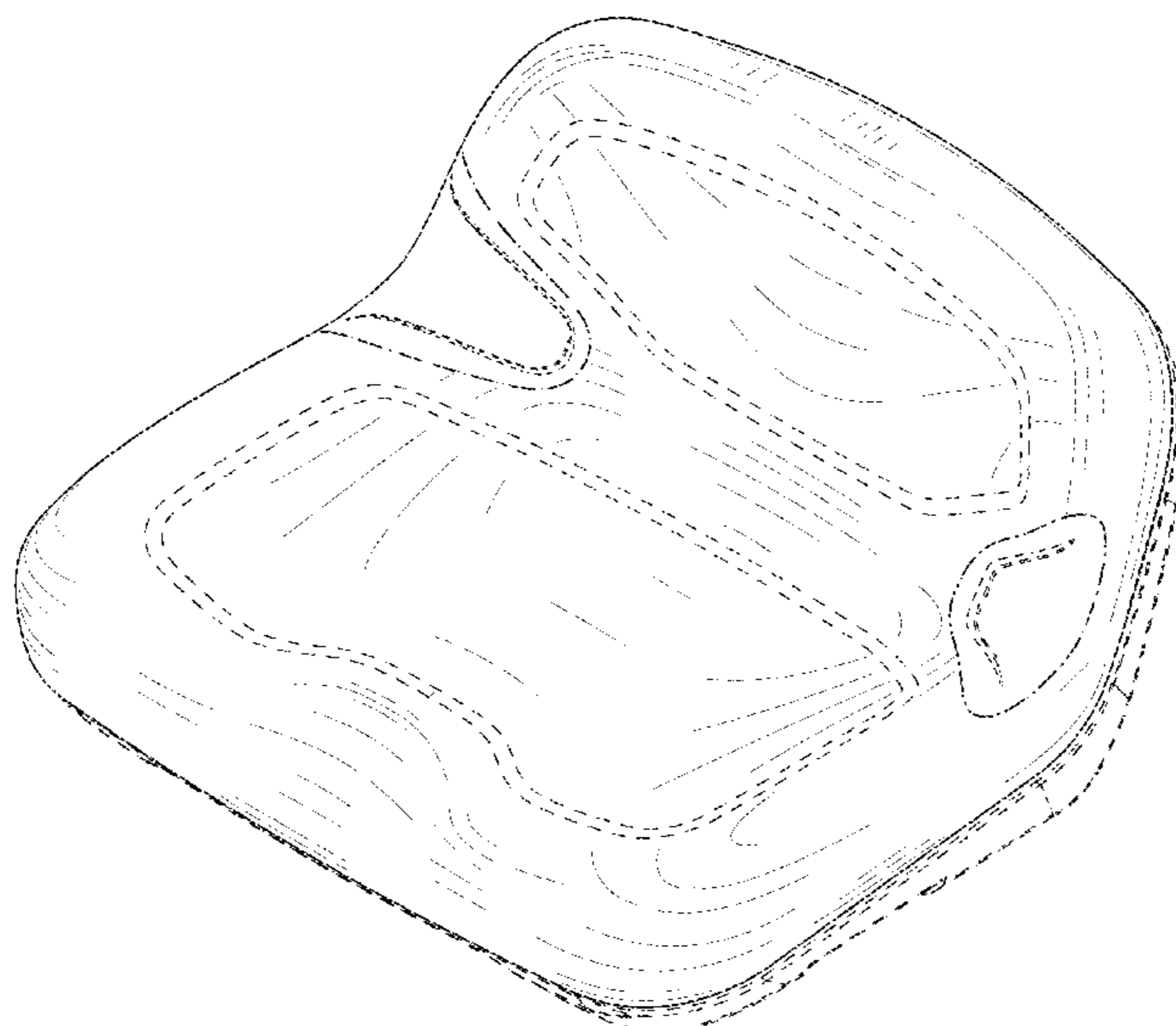

(56)

References Cited

U.S. PATENT DOCUMENTS

D663,962 S *	7/2012	Muelder	D6/356
D724,334 S *	3/2015	Ashley	D6/356
2005/0183653 A1 *	8/2005	Lewis	B63B 29/06 114/363
2005/0183655 A1 *	8/2005	Lewis	B63B 29/06 114/363

* cited by examiner

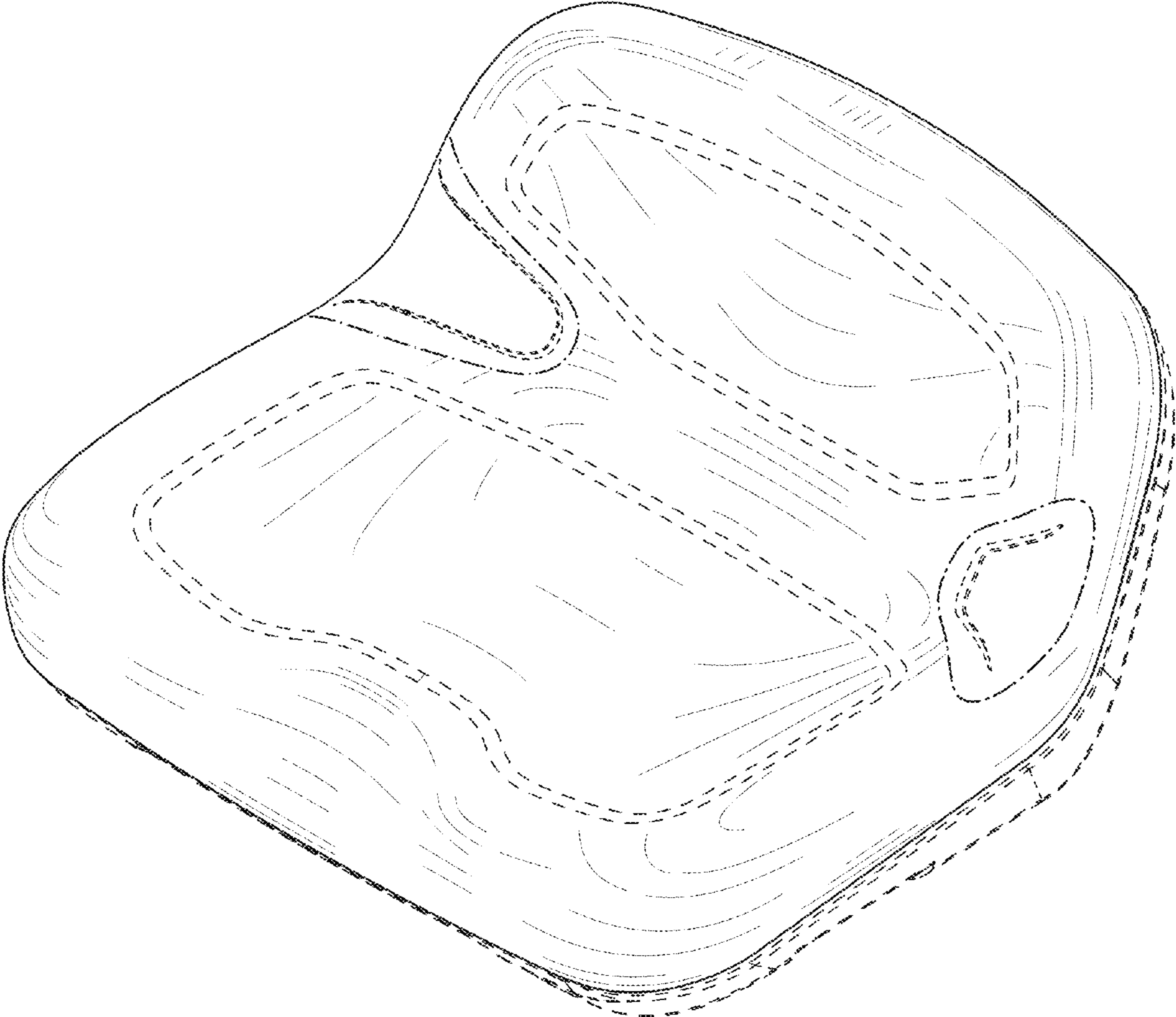

FIG. 1

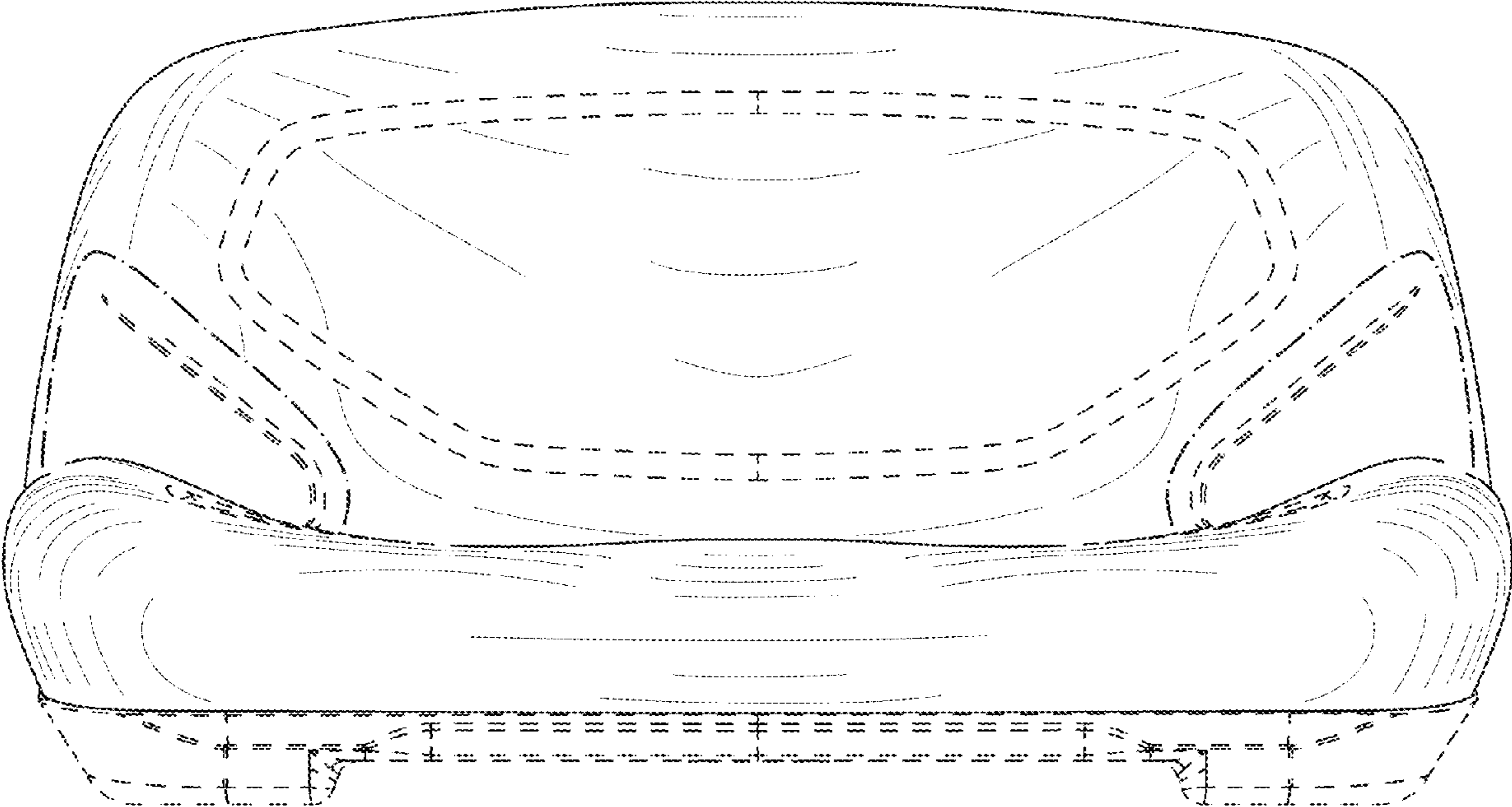

FIG. 2

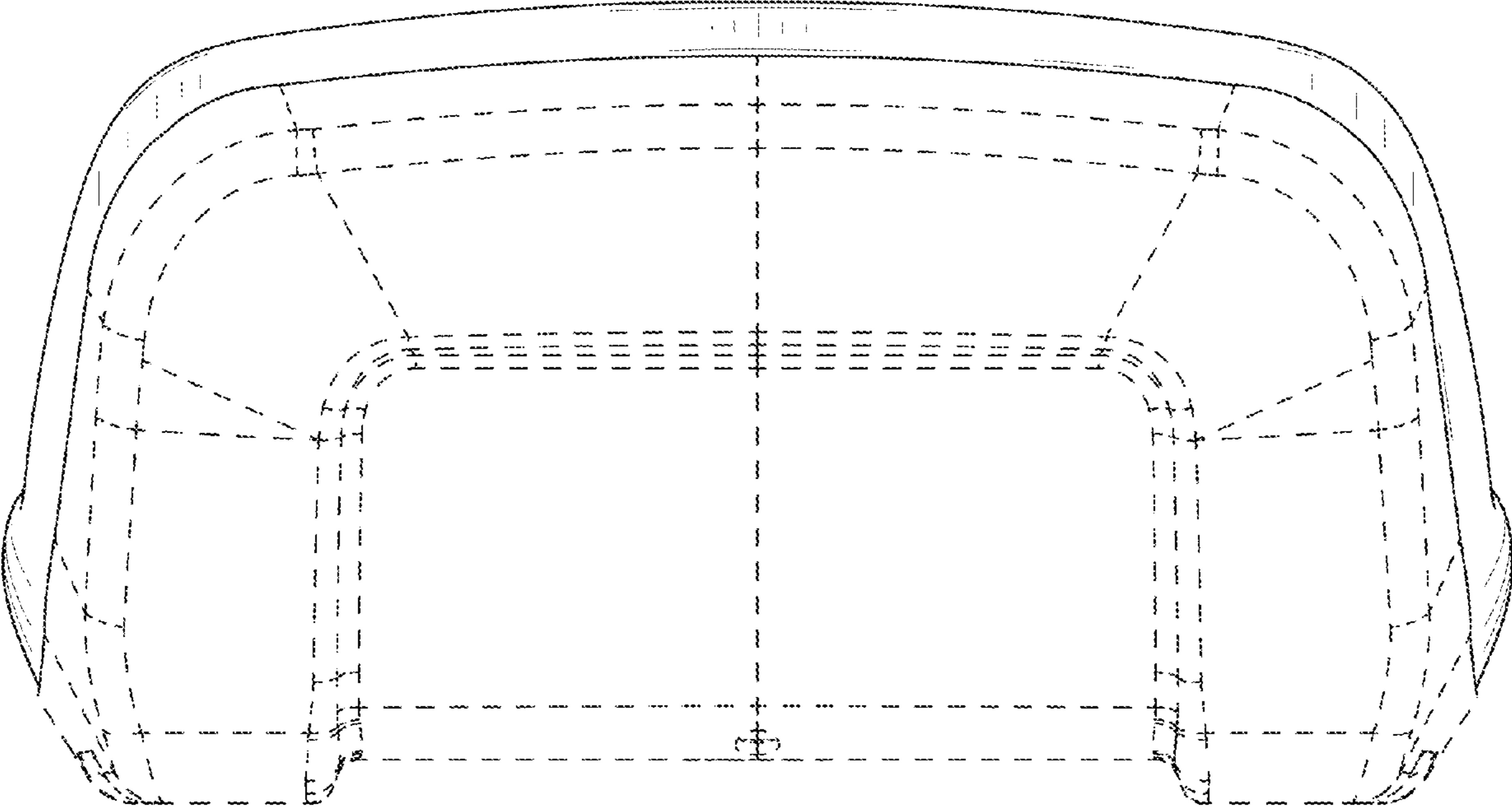

FIG. 3

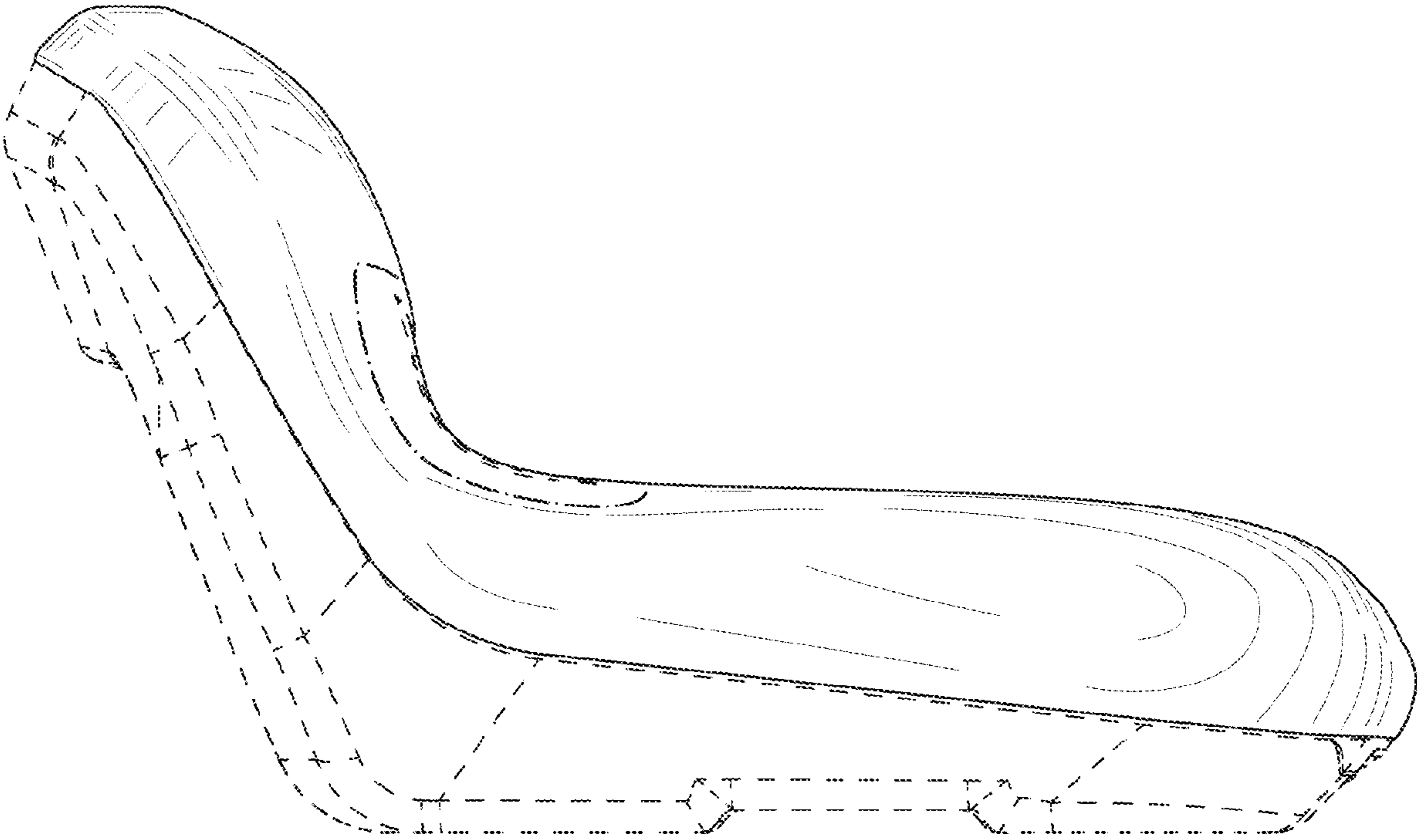

FIG. 4

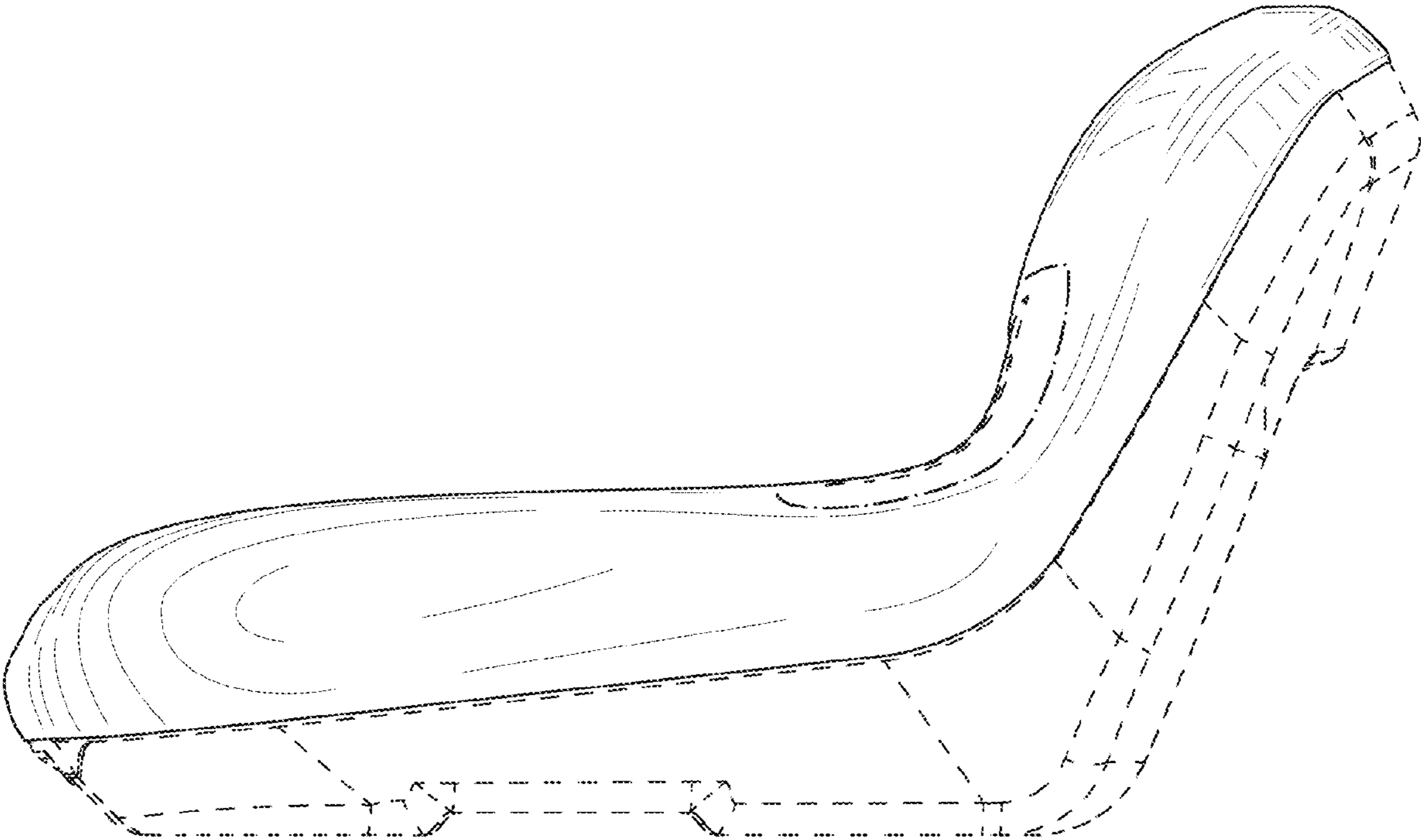

FIG. 5

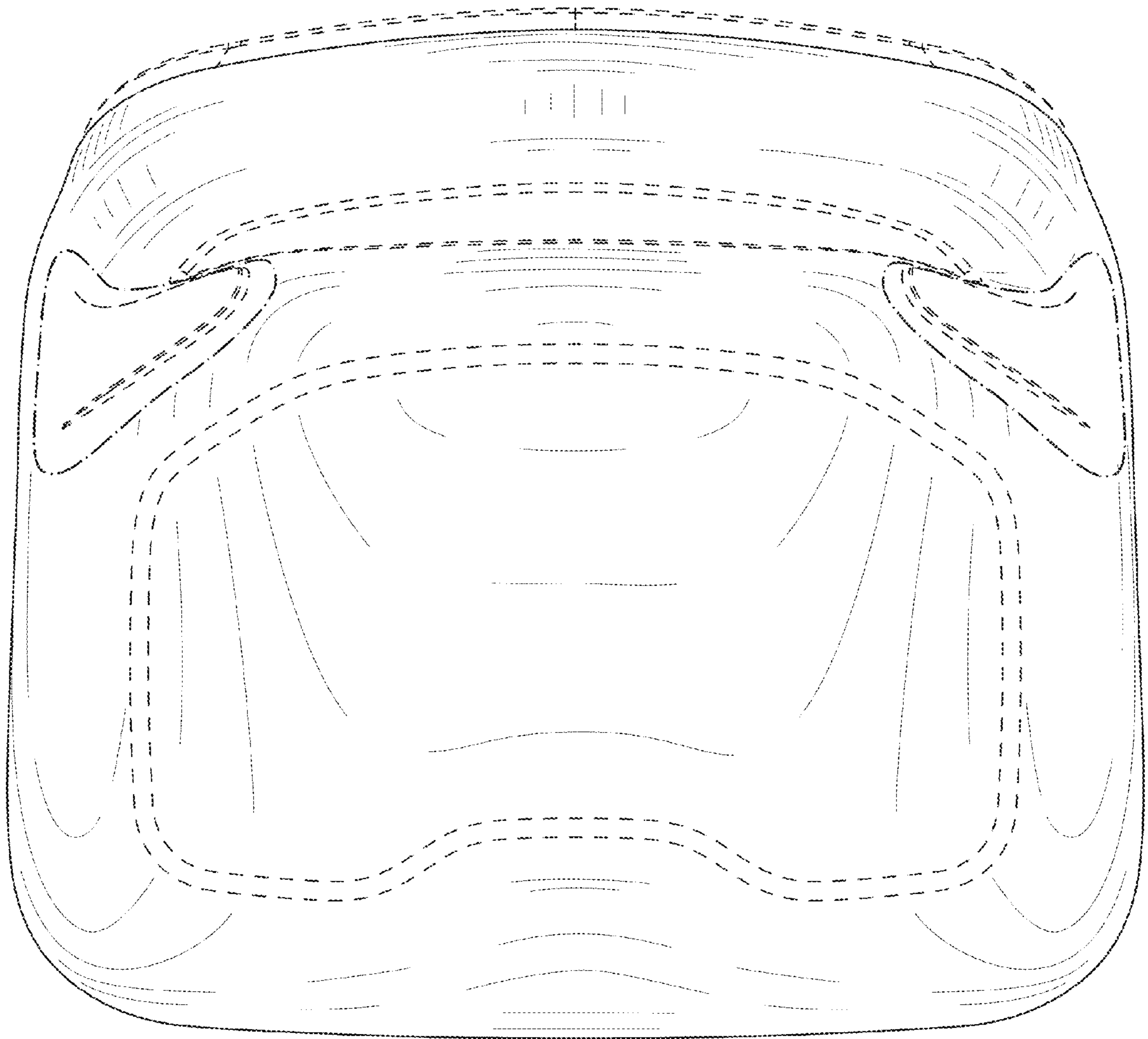

FIG. 6

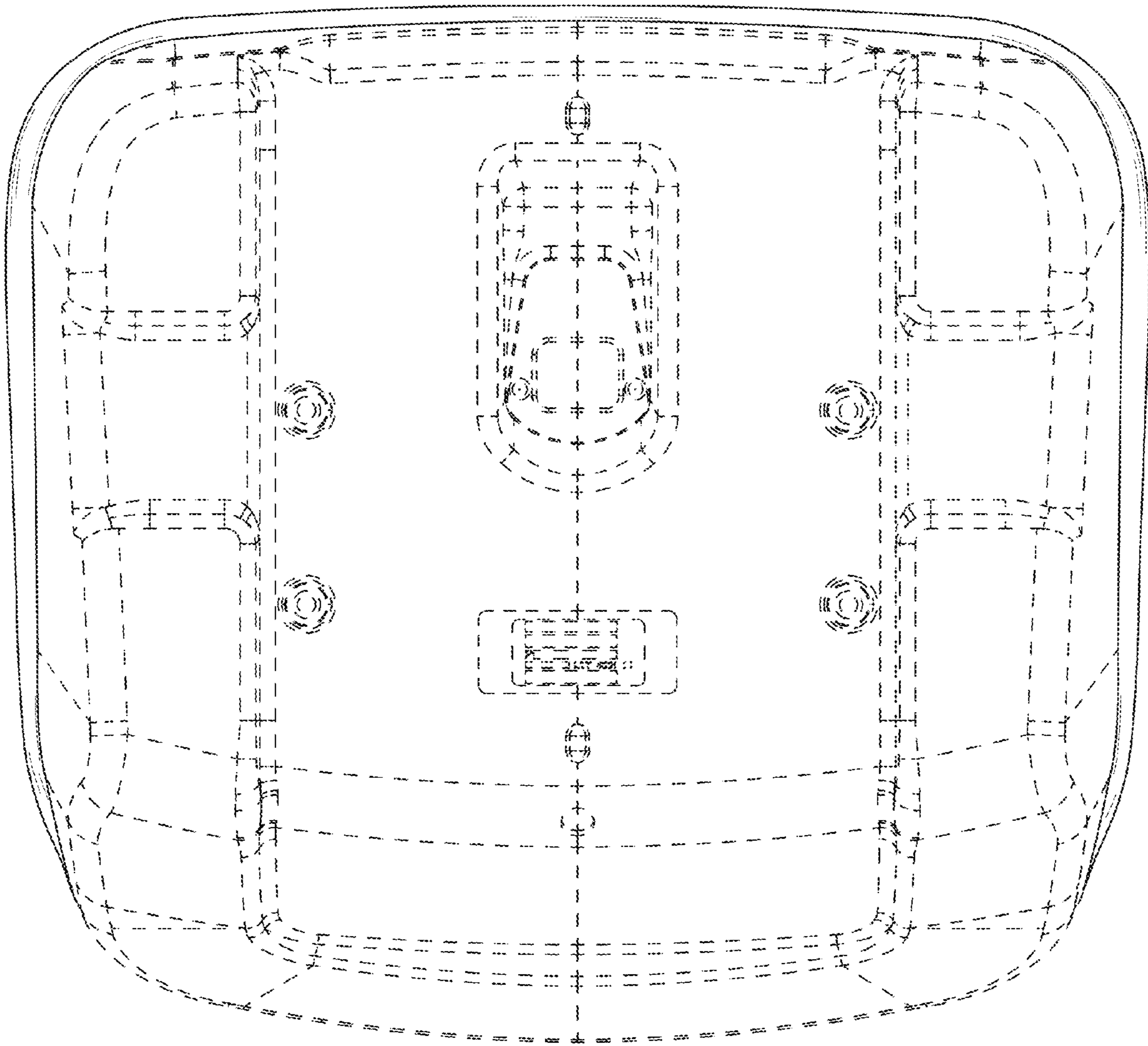

FIG. 7