



US00D887131S

(12) **United States Design Patent**
Smith

(10) **Patent No.:** **US D887,131 S**
(45) **Date of Patent:** **** Jun. 16, 2020**

(54) **RECEIPT HOLDER**

DESCRIPTION

(71) Applicant: **Kim Smith**, Van Nuys, CA (US)
(72) Inventor: **Kim Smith**, Van Nuys, CA (US)
(**) Term: **15 Years**
(21) Appl. No.: **29/675,862**
(22) Filed: **Jan. 6, 2019**
(51) **LOC (12) Cl.** **03-01**
(52) **U.S. Cl.**
USPC **D3/247**
(58) **Field of Classification Search**
USPC D3/247, 249–253
CPC A45C 1/06; A45C 3/08
See application file for complete search history.

(56) **References Cited**

U.S. PATENT DOCUMENTS

D511,038 S * 11/2005 Schrey D3/249
D553,856 S * 10/2007 Shum D3/247
D686,413 S * 7/2013 Bartos D3/247
D772,569 S * 11/2016 Tappeiner D3/247
D836,335 S * 12/2018 Serman D3/247
D836,336 S * 12/2018 Serman D3/247

* cited by examiner

Primary Examiner — Holly H Baynham
(74) *Attorney, Agent, or Firm* — Loza & Loza, LLP;
Heidi L. Eisenhut

(57) **CLAIM**

The ornamental design for a receipt holder, as shown and described.

FIG. 1 is a top right perspective of a receipt holder in a closed configuration, according to the present invention. FIG. 2 is a bottom right perspective of the receipt holder of FIG. 1; FIG. 3 is a front elevation view of the receipt holder of FIG. 1; FIG. 4 is a back elevation view of the receipt holder of FIG. 1; FIG. 5 is a first side elevation view of the receipt holder of FIG. 1; FIG. 6 is a second side elevation view of the receipt holder of FIG. 1; FIG. 7 top plan view of the receipt holder of FIG. 1; FIG. 8 is a bottom plan view of the receipt holder of FIG. 1; FIG. 9 is a top right perspective view of the receipt holder of FIG. 1 in an open configuration; and FIG. 10 is a bottom right perspective of the receipt holder of FIG. 1 in an open configuration; FIG. 11 is a front elevation view of the receipt holder of FIG. 1 in an open configuration; FIG. 12 is a back elevation view of the receipt holder of FIG. 1 in an open configuration; FIG. 13 is a first side elevation view of the receipt holder of FIG. 1 in an open configuration; FIG. 14 is a second side elevation view of the receipt holder of FIG. 1 in an open configuration; FIG. 15 is a top plan view of the receipt holder of FIG. 1 in an open configuration; and, FIG. 16 is a bottom plan view of the receipt holder of FIG. 1 in an open configuration.

1 Claim, 6 Drawing Sheets

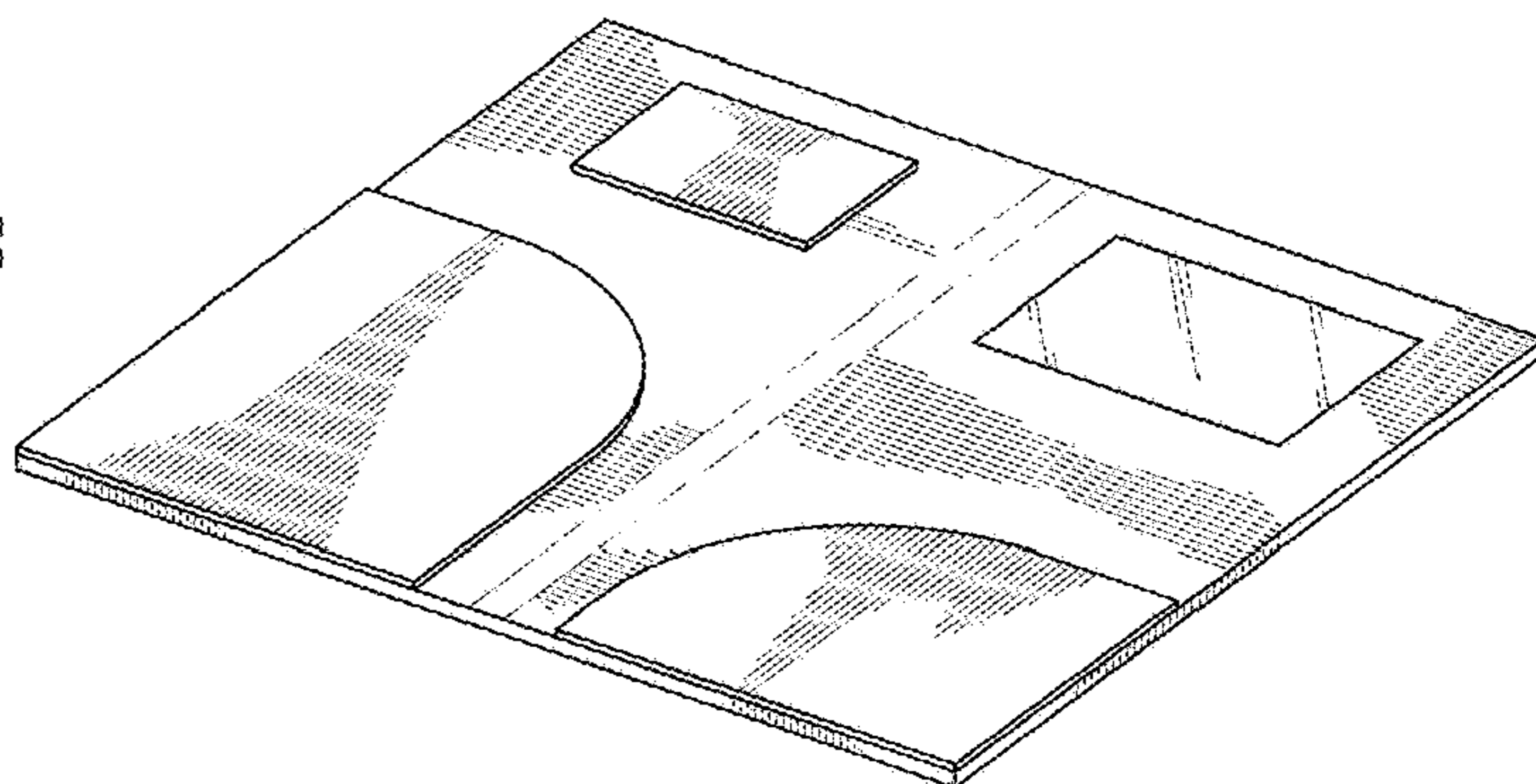
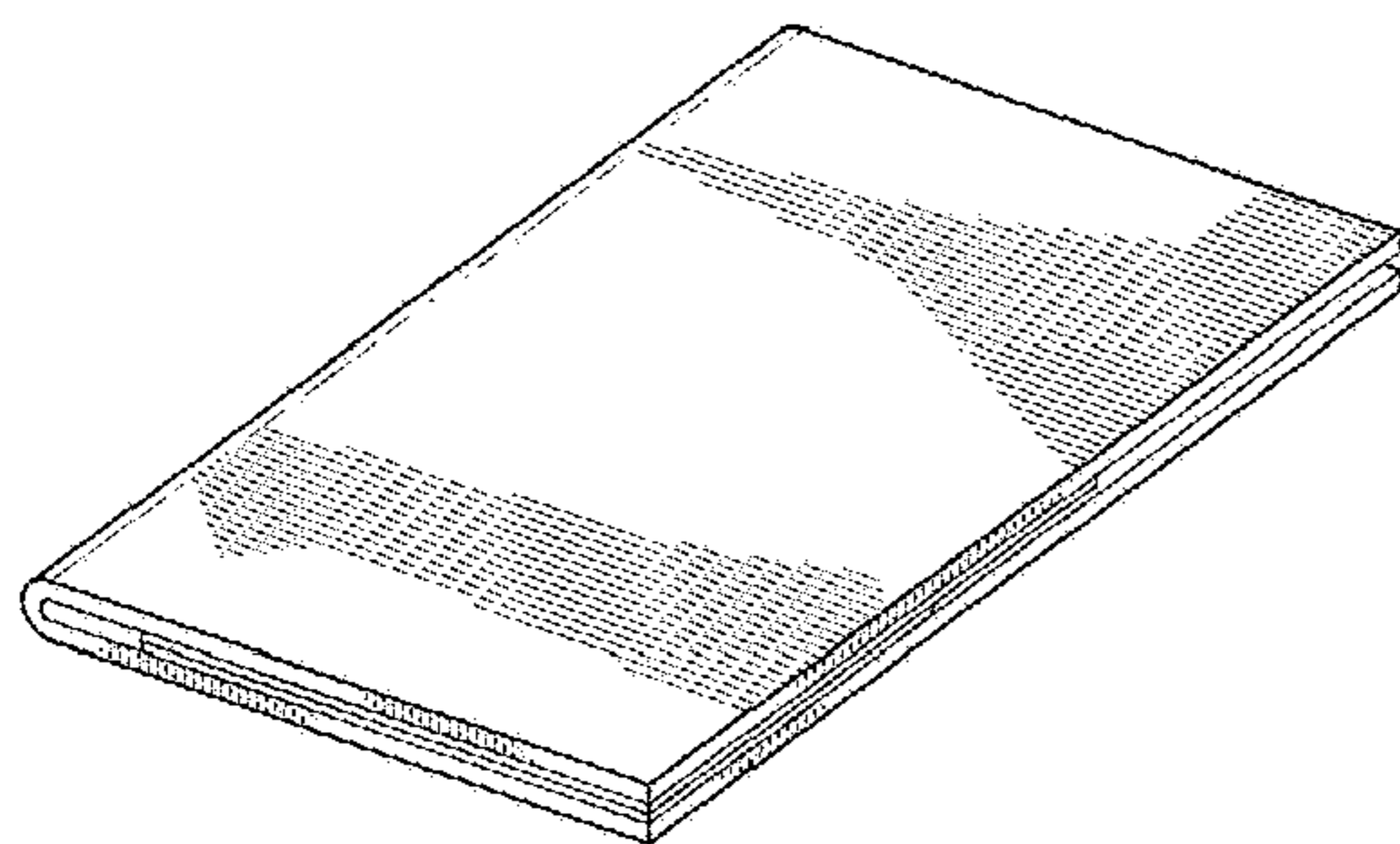

FIG. 1

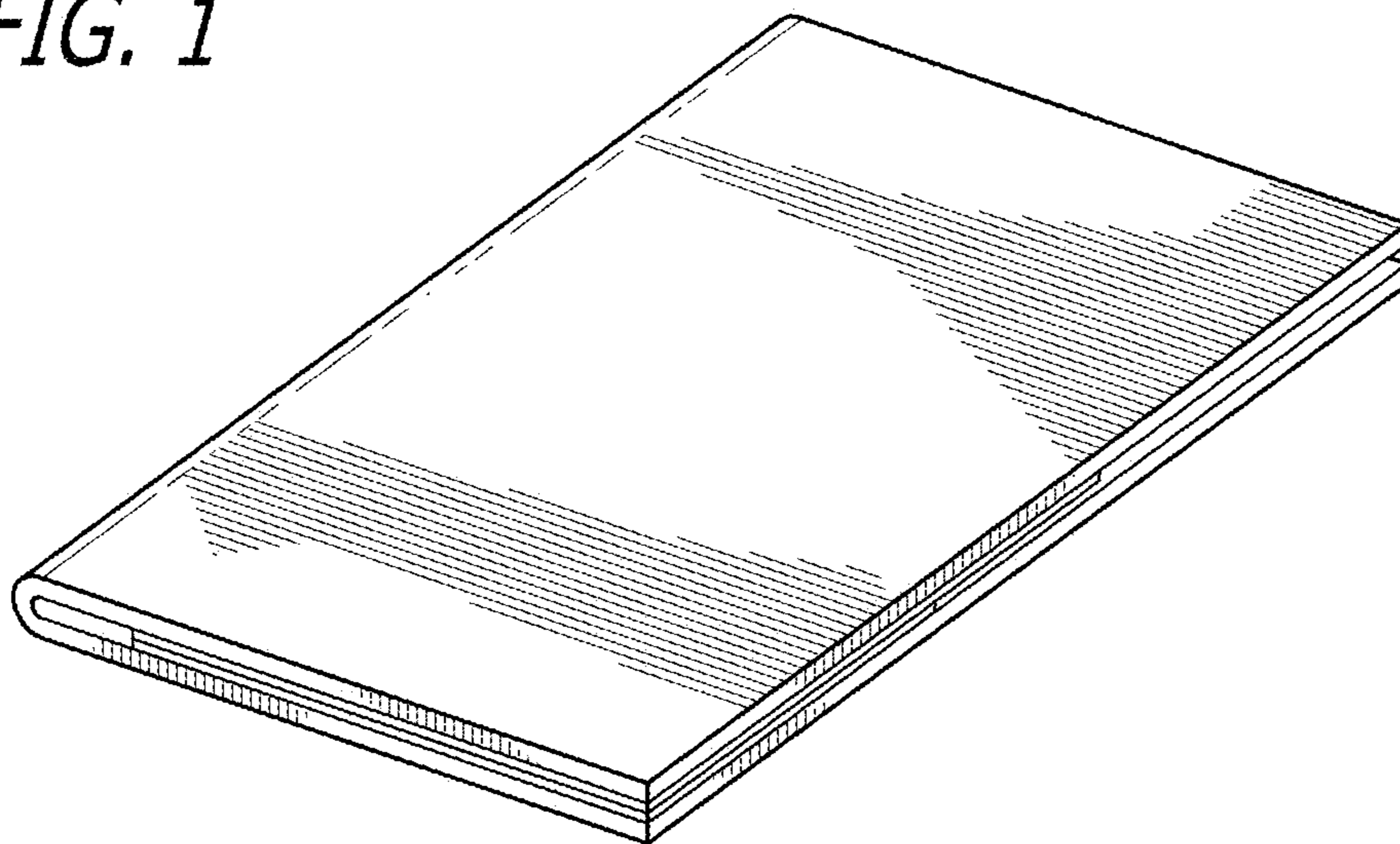

FIG. 2

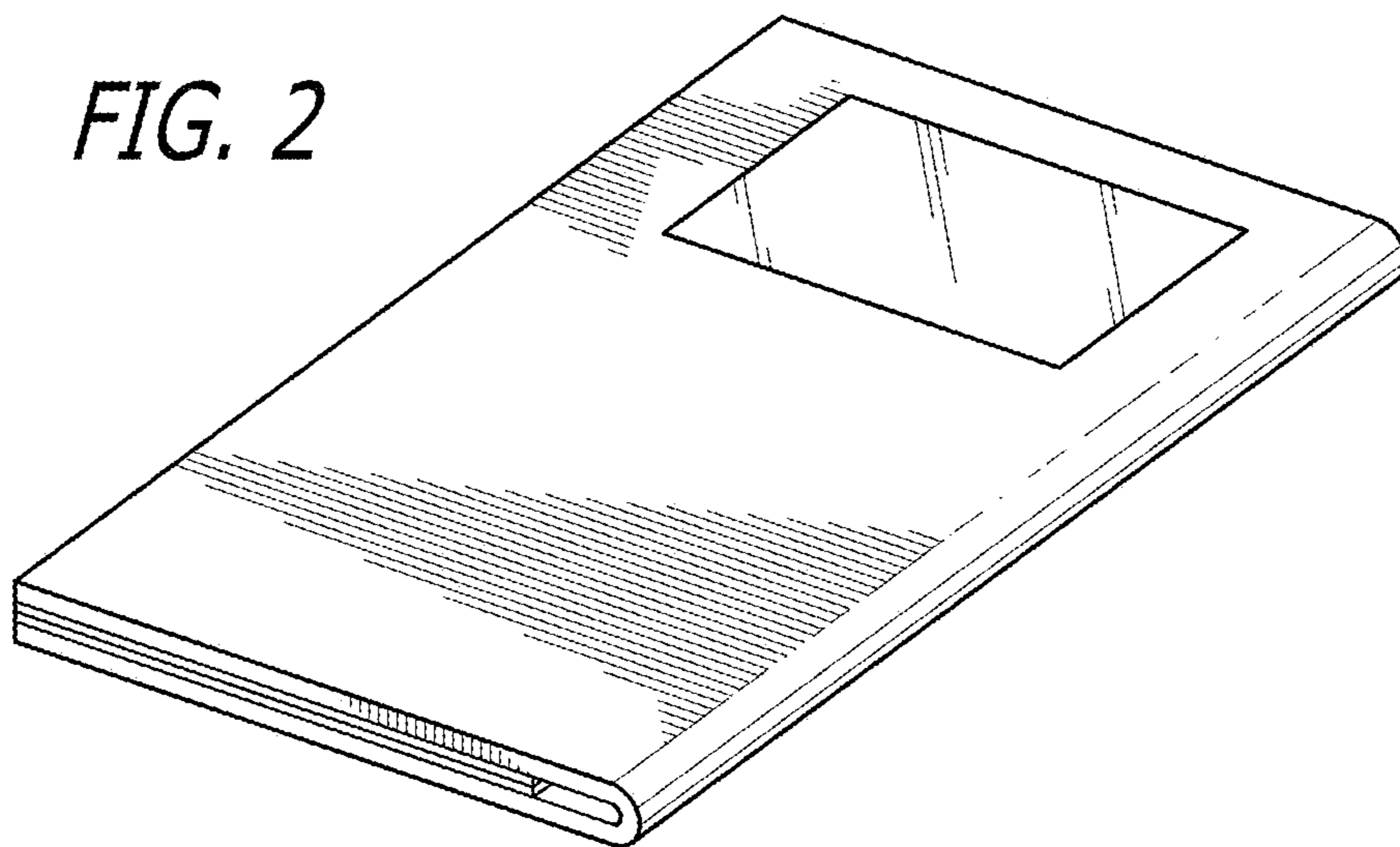



FIG. 3

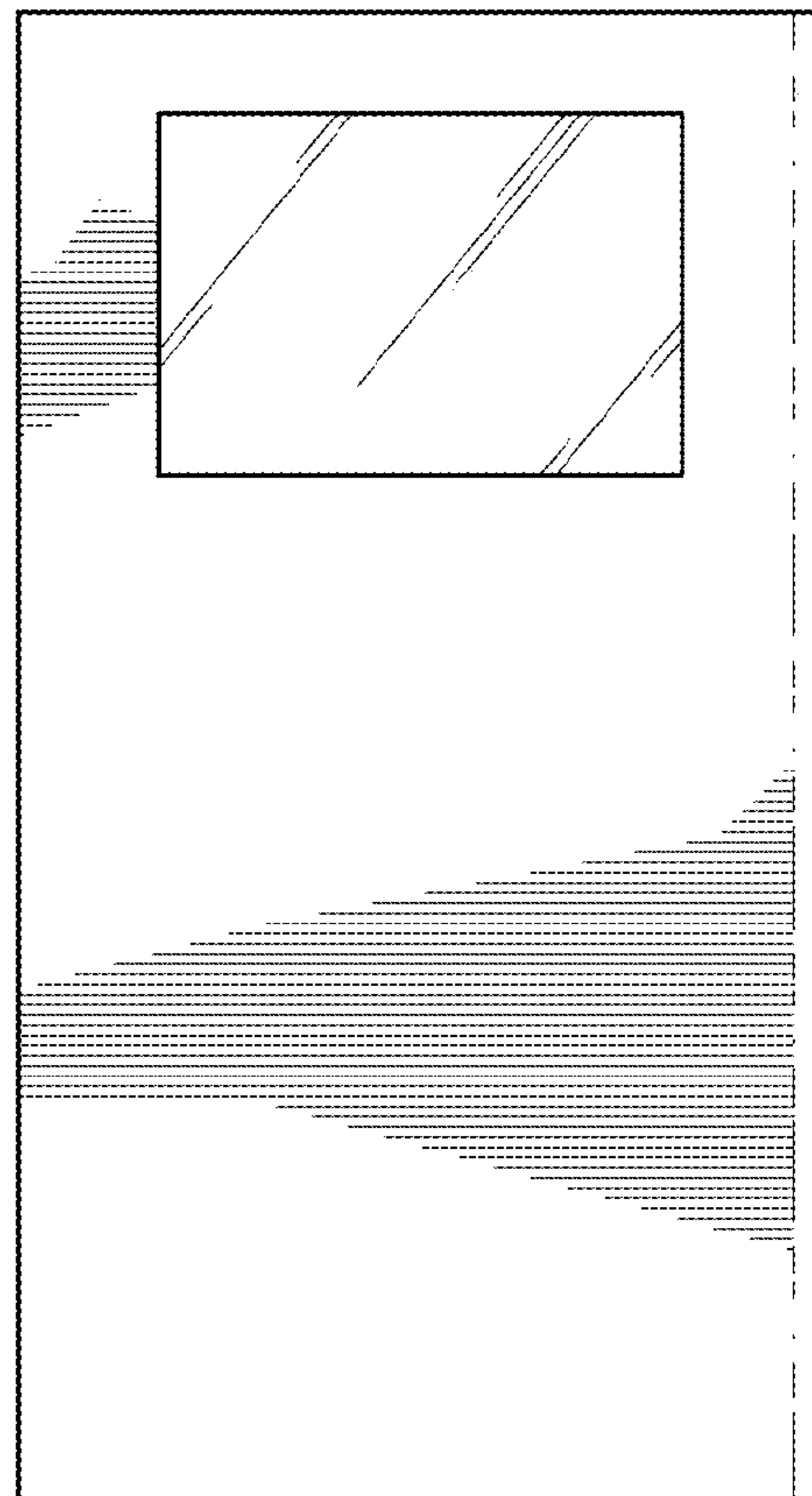

FIG. 4

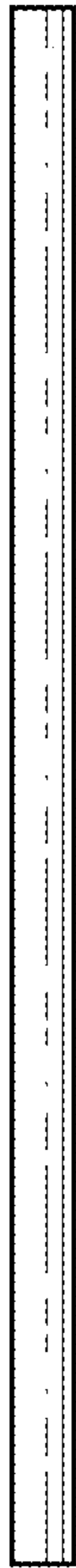

FIG. 5

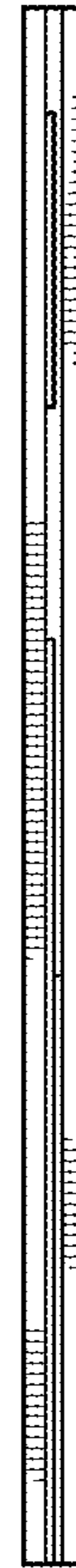

FIG. 6



FIG. 7

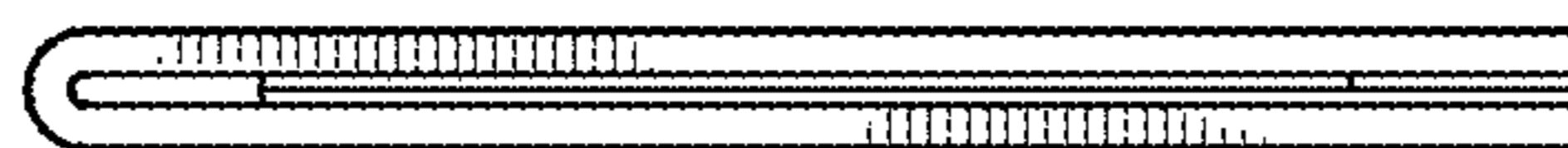

FIG. 8

FIG. 9

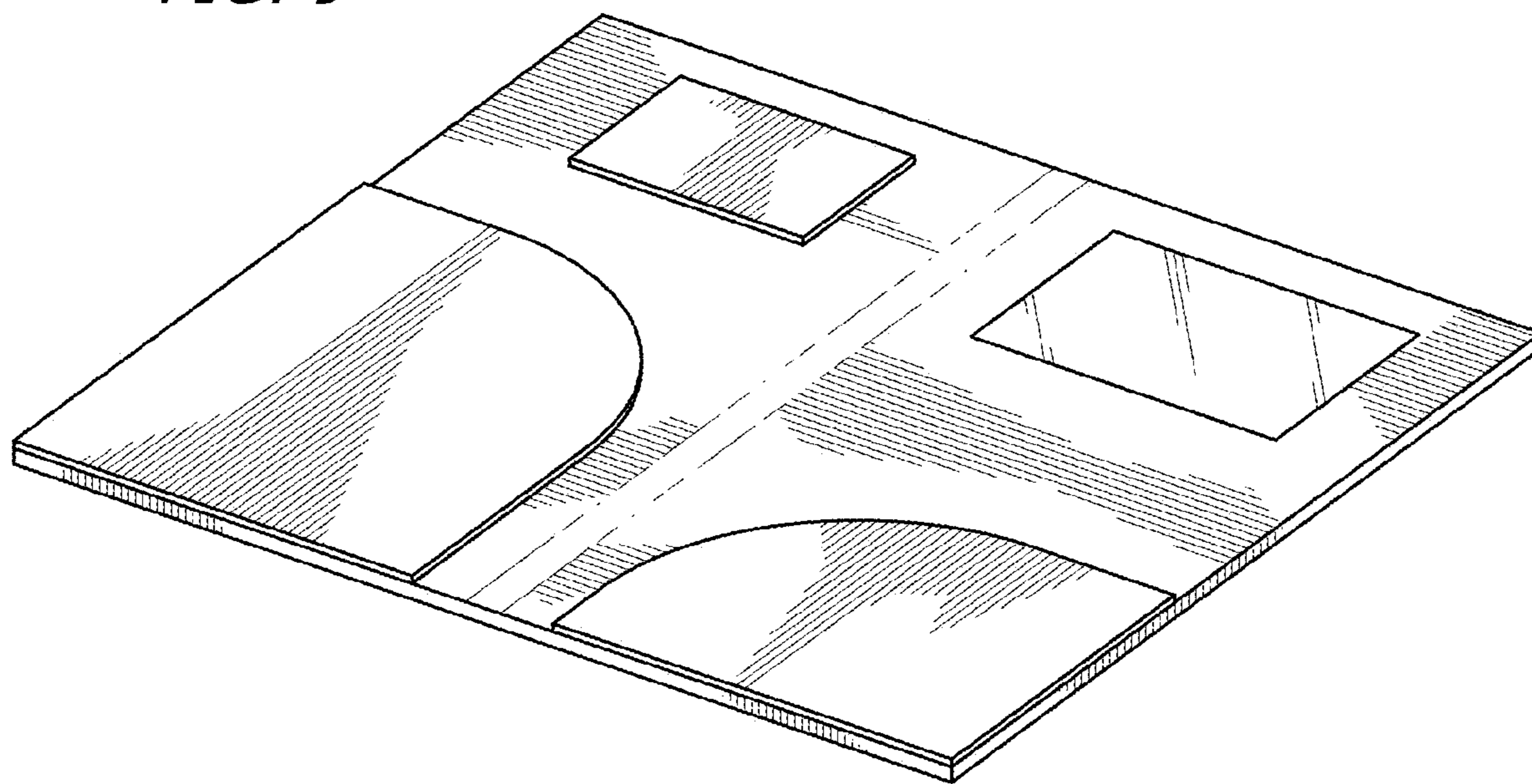

FIG. 10

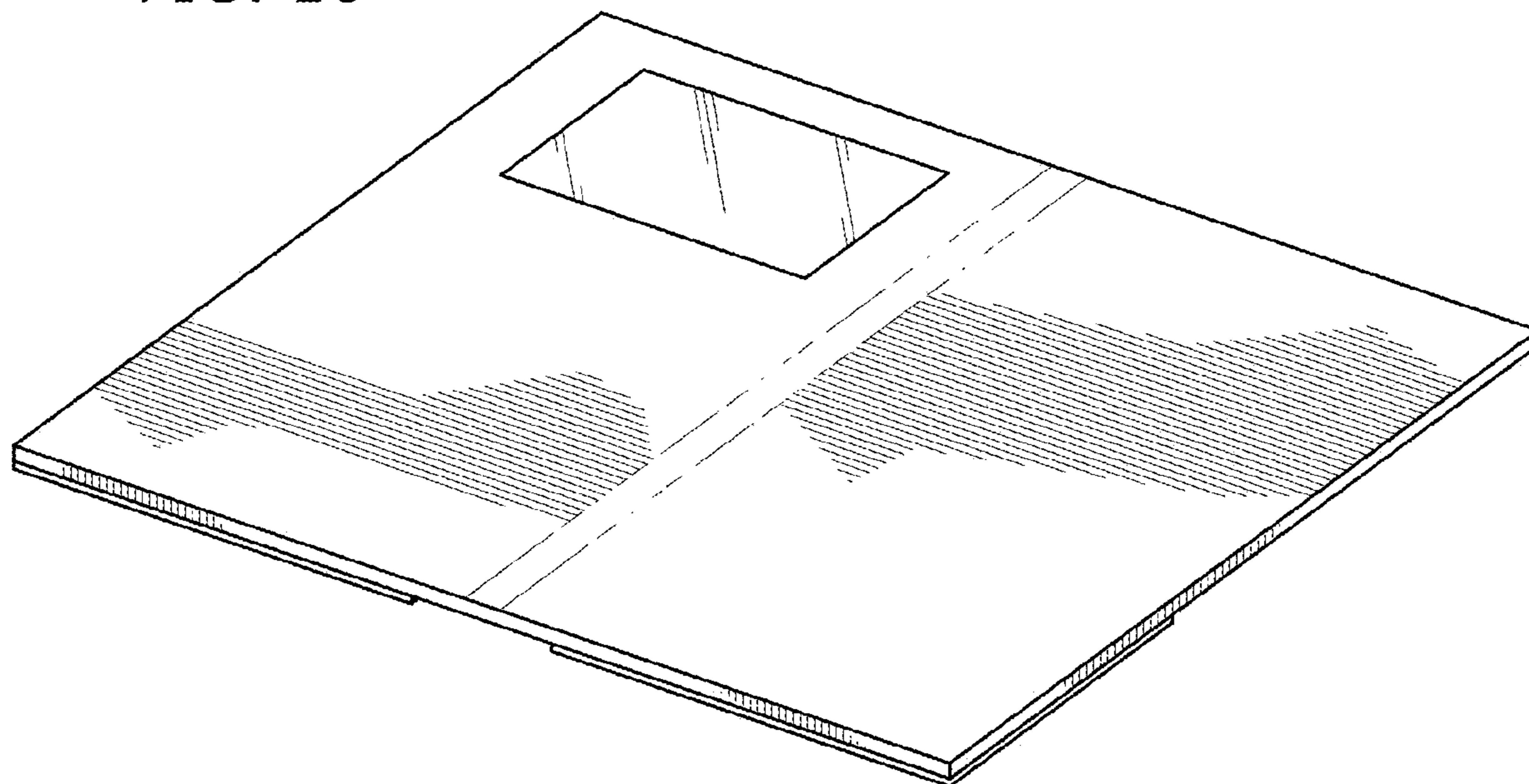

FIG. 11

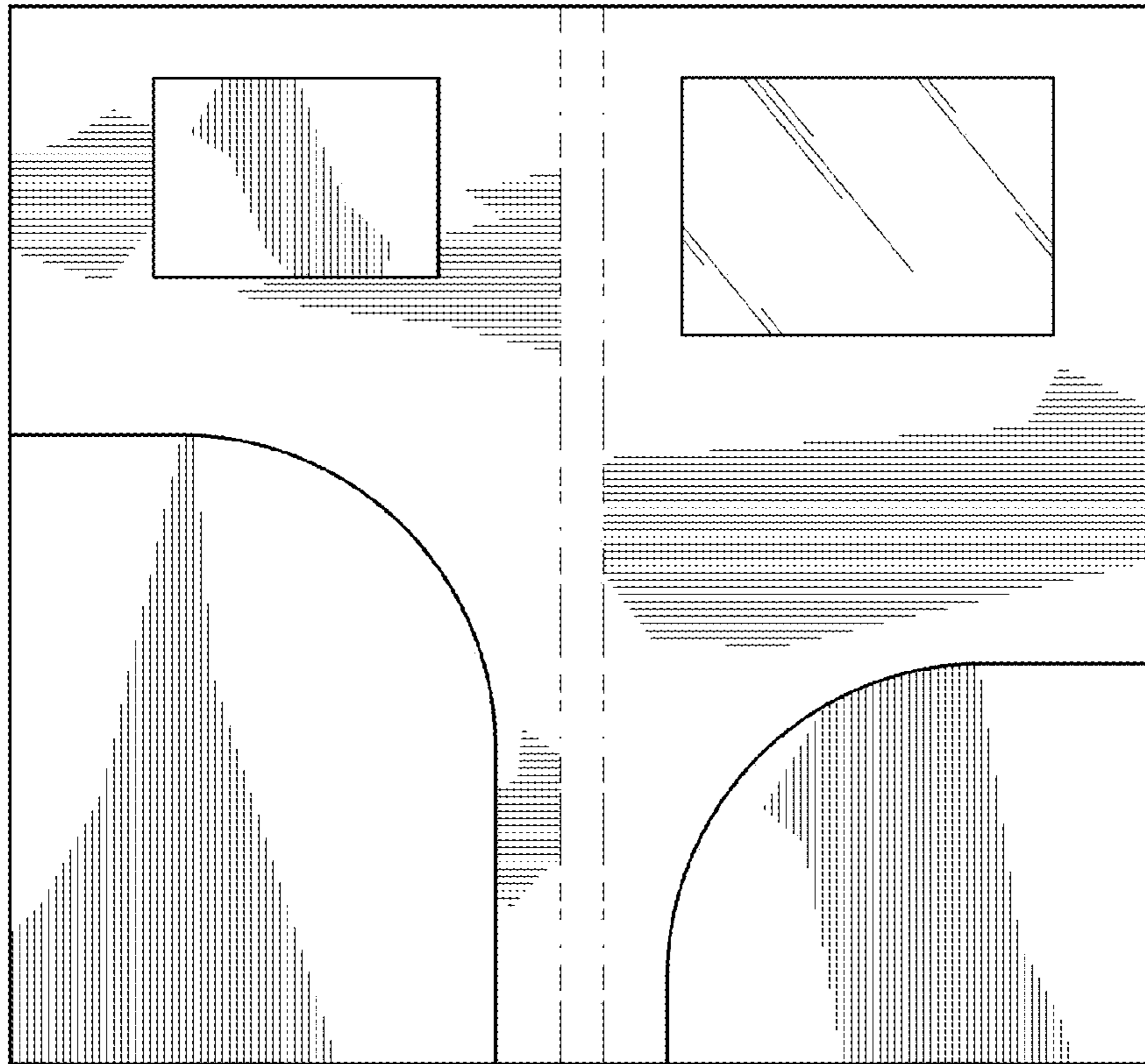

FIG. 12

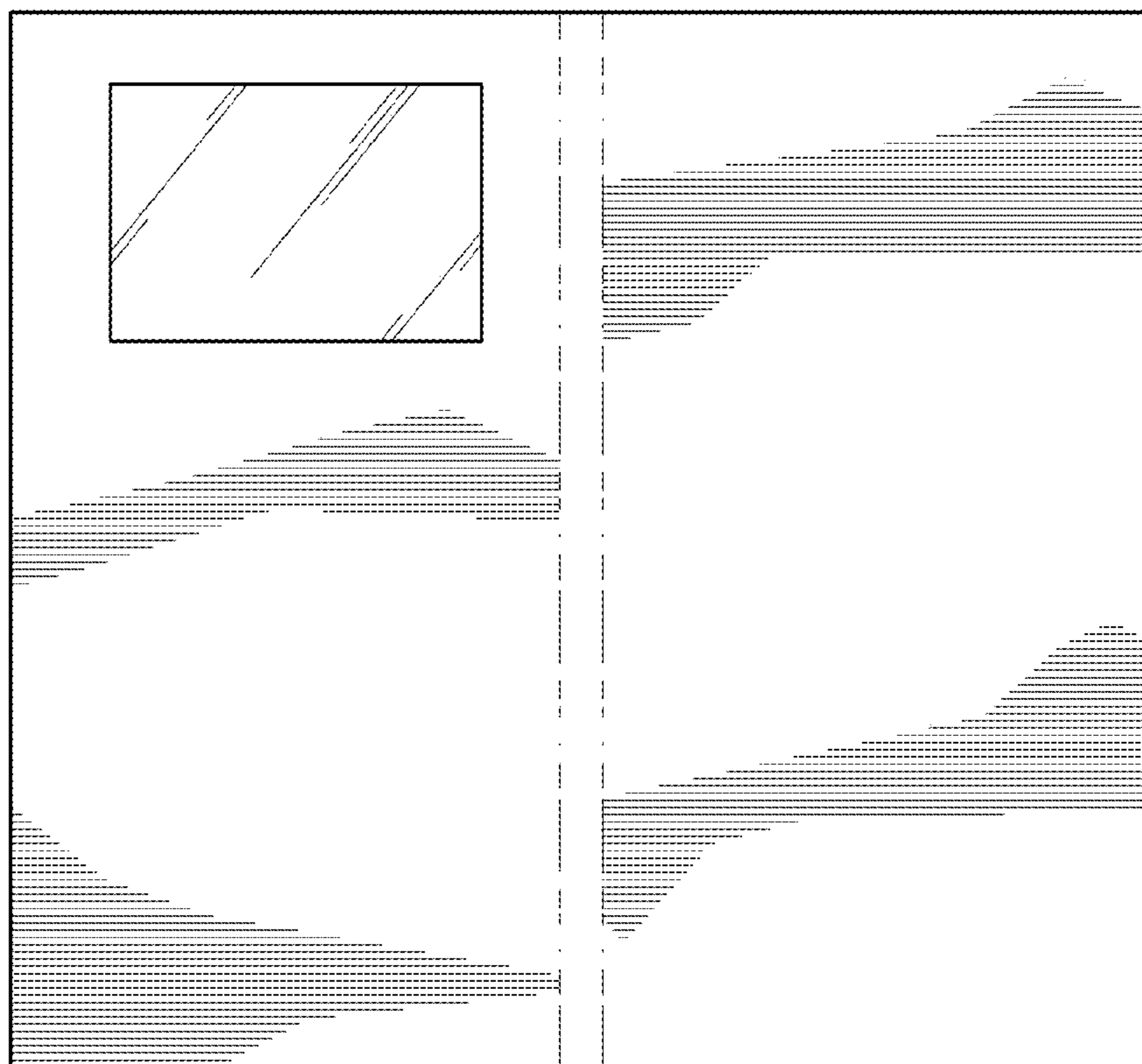



FIG. 13



FIG. 14

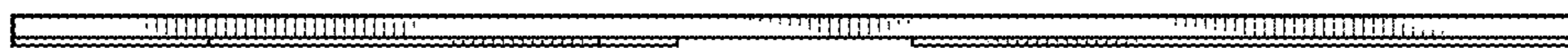

FIG. 15

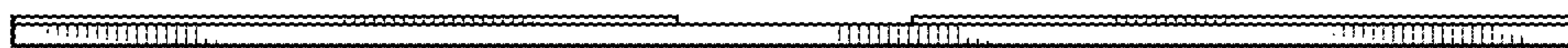

FIG. 16