



US00D887129S

(12) **United States Design Patent**  
**Zhao**

(10) **Patent No.:** **US D887,129 S**  
(45) **Date of Patent:** **\*\* Jun. 16, 2020**

(54) **BELT CLIP CASE WITH IDENTIFICATION HOLDER**

(71) Applicant: **Bo Zhao**, Whitestone, NY (US)

(72) Inventor: **Bo Zhao**, Whitestone, NY (US)

(\*\*) Term: **15 Years**

(21) Appl. No.: **29/677,873**

(22) Filed: **Jan. 24, 2019**

(51) **LOC (12) Cl.** ..... **03-01**

(52) **U.S. Cl.**  
USPC ..... **D3/226**

(58) **Field of Classification Search**  
USPC ..... D3/215, 218, 224, 225, 230, 247–251,  
D3/303; 224/240–241, 197, 578, 674,  
224/904, 929–930; 150/141, 145  
CPC ..... A45F 3/14; A45F 5/00; A45F 5/02; A45F  
5/0221; A45F 2003/144; A45C 1/00;  
A45C 1/06  
See application file for complete search history.

(56) **References Cited**

U.S. PATENT DOCUMENTS

2,288,704 A \* 7/1942 Herbener ..... A45C 1/06  
150/141  
D133,556 S \* 8/1942 Wege ..... D3/249  
6,729,518 B2 \* 5/2004 Badillo ..... A45F 5/00  
224/240

D602,689 S \* 10/2009 Hewitt ..... D3/247  
8,073,131 B2 \* 12/2011 Bodkin ..... A45F 5/02  
224/250  
D681,949 S \* 5/2013 Kershenstein ..... D3/249  
D738,620 S 9/2015 Schmole  
D740,548 S 10/2015 Hassler et al.  
D761,011 S \* 7/2016 Grote ..... D3/226  
D767,888 S 10/2016 Kim  
D777,421 S 1/2017 Grote  
D782,816 S 4/2017 Boyd et al.  
D793,082 S 8/2017 Zhang

\* cited by examiner

*Primary Examiner* — Catherine R Oliver-Garcia  
(74) *Attorney, Agent, or Firm* — Goldstein Law Offices,  
P.C.

(57) **CLAIM**

The ornamental design for a belt clip case with identification holder, as shown and described.

**DESCRIPTION**

FIG. 1 is a perspective view of the belt clip case with identification holder.  
FIG. 2 is a front elevational view of the belt clip case with identification holder.  
FIG. 3 is a rear elevational view thereof;  
FIG. 4 is a top plan view thereof.  
FIG. 5 is a bottom plan view thereof.  
FIG. 6 is a left side elevational view thereof; and,  
FIG. 7 is a right side elevational view thereof.

**1 Claim, 4 Drawing Sheets**

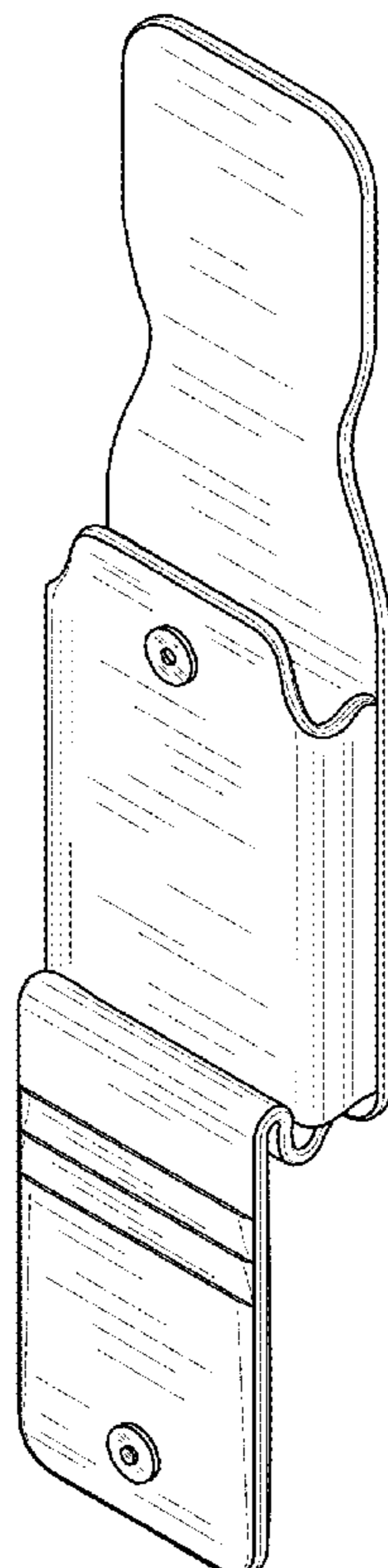

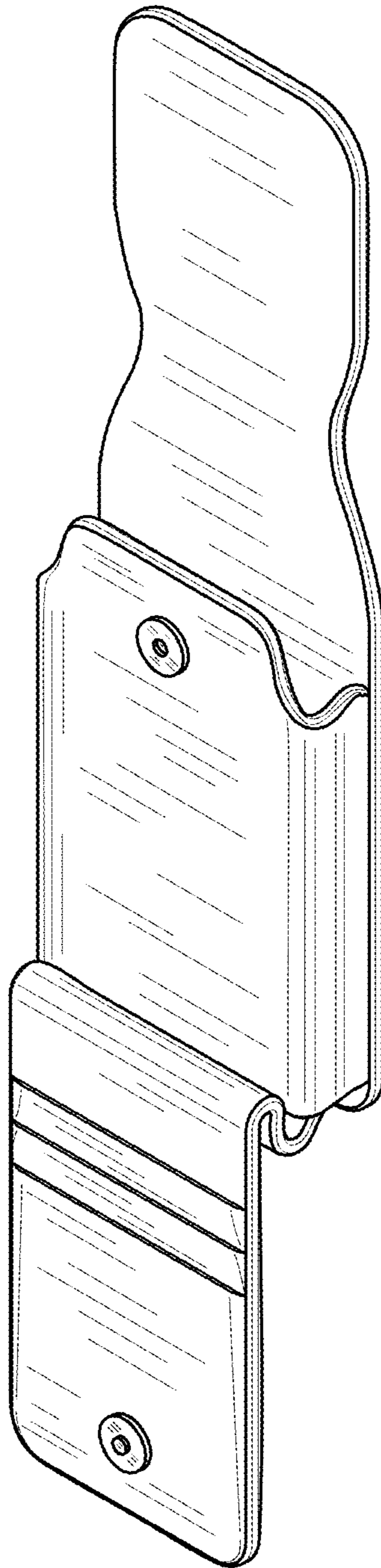

FIG. 1

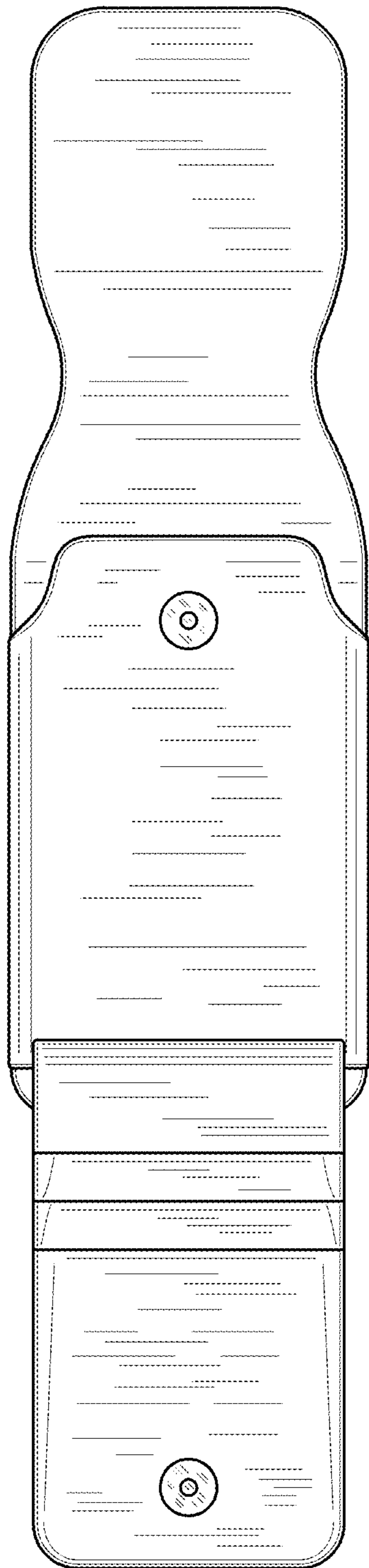

FIG. 2

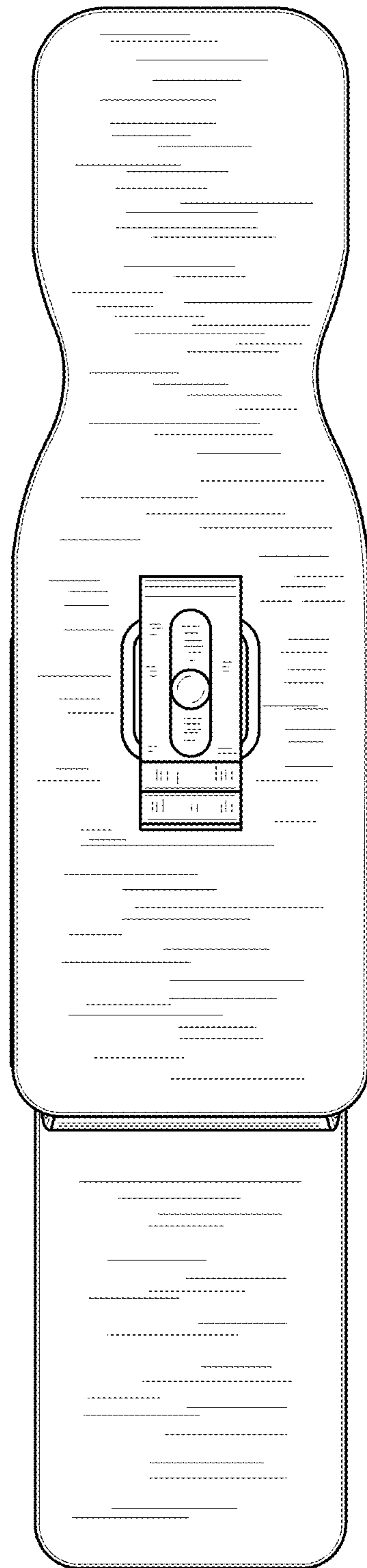
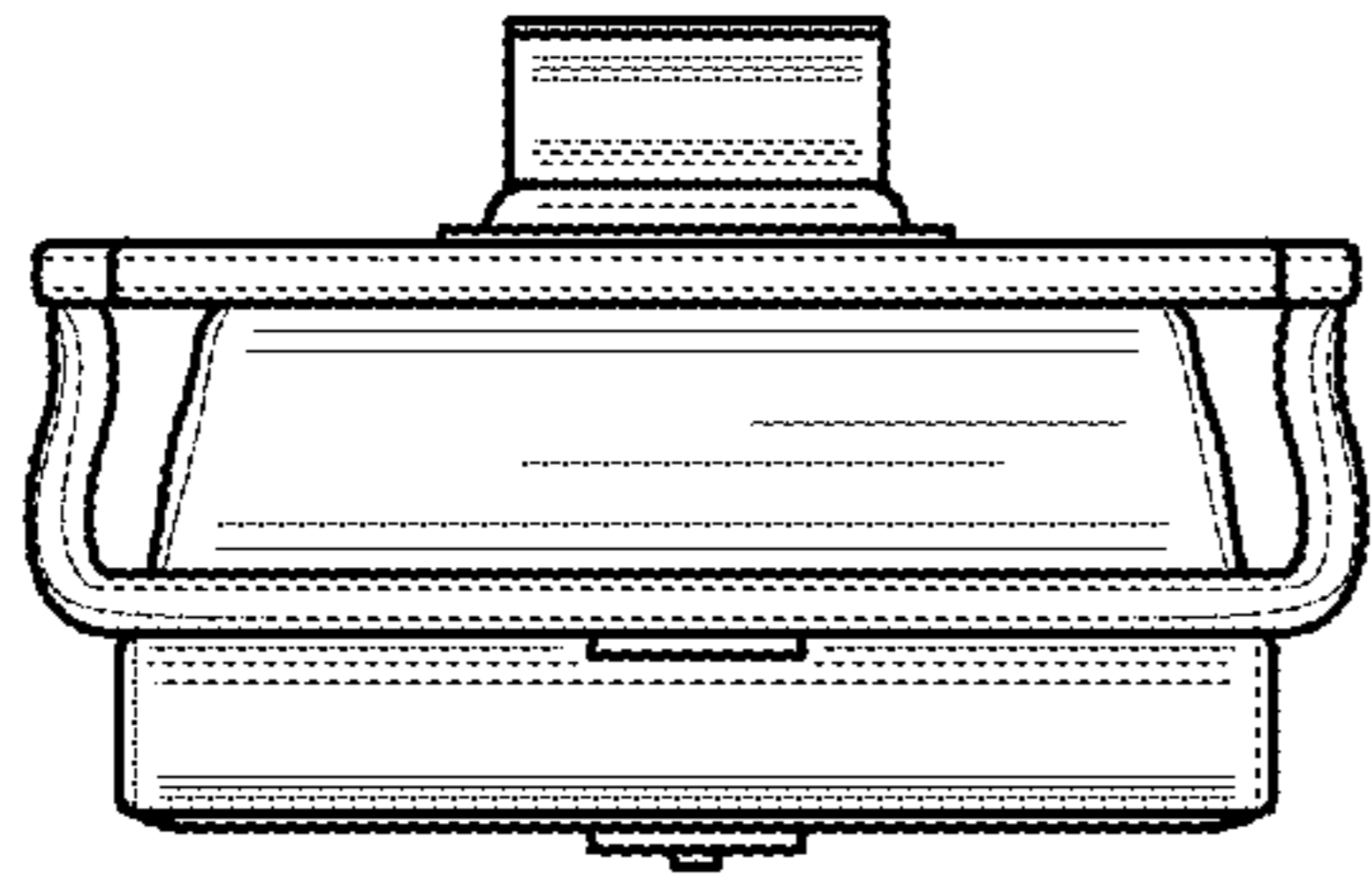
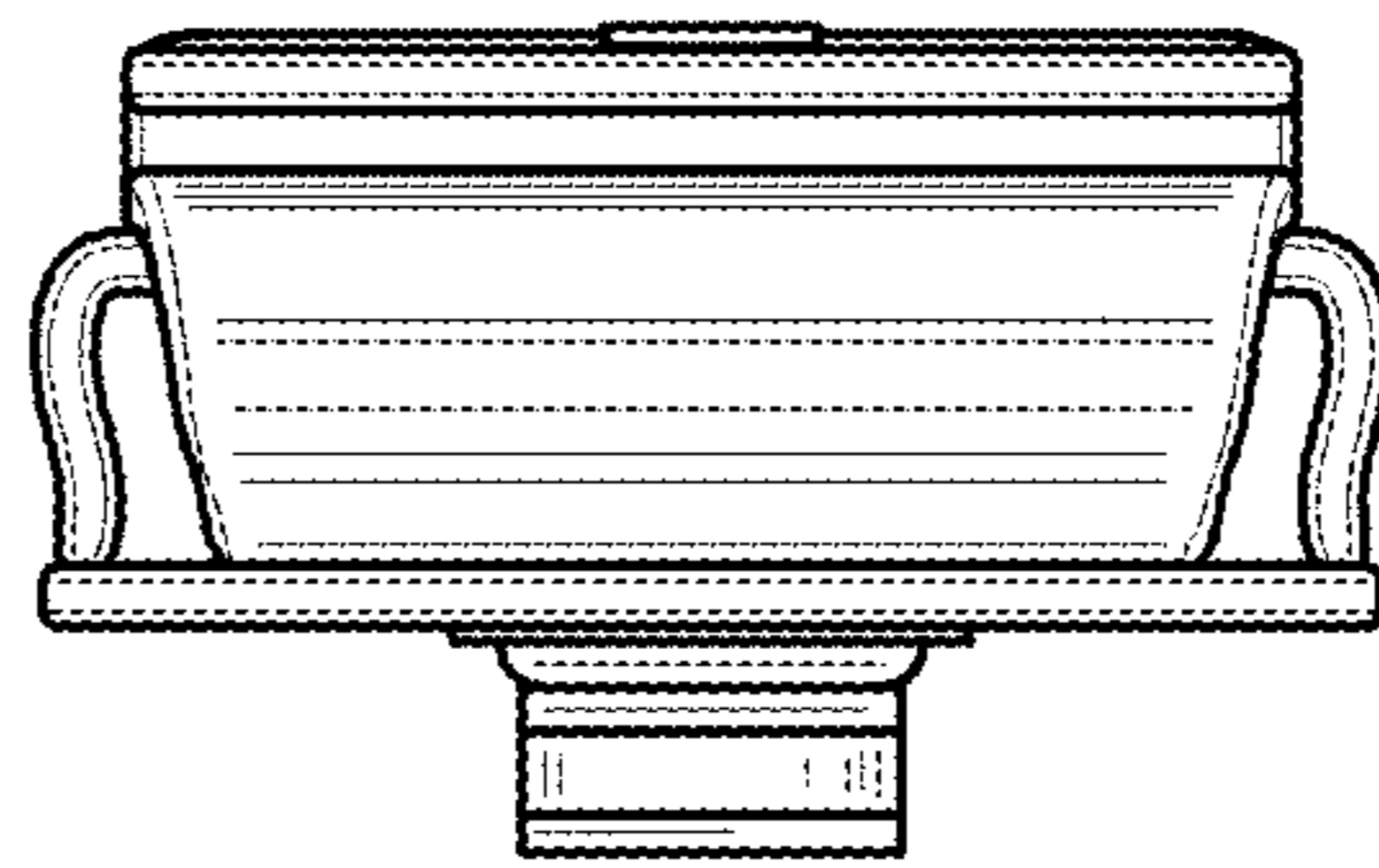

FIG. 3



*FIG. 4*



*FIG. 5*

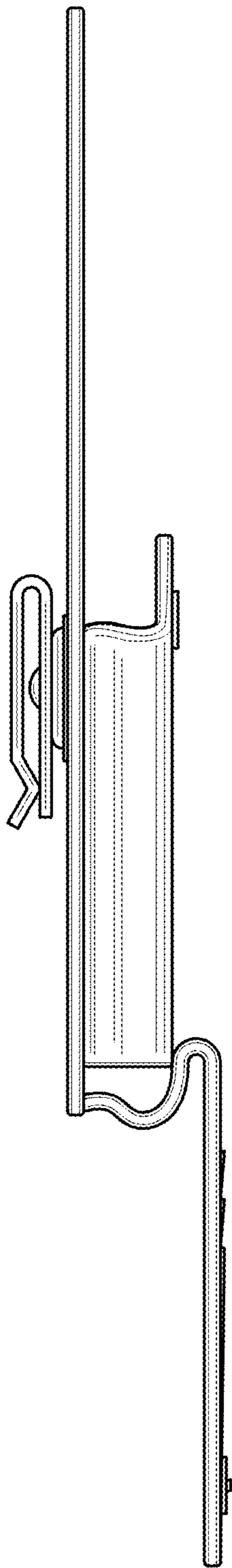

FIG. 6

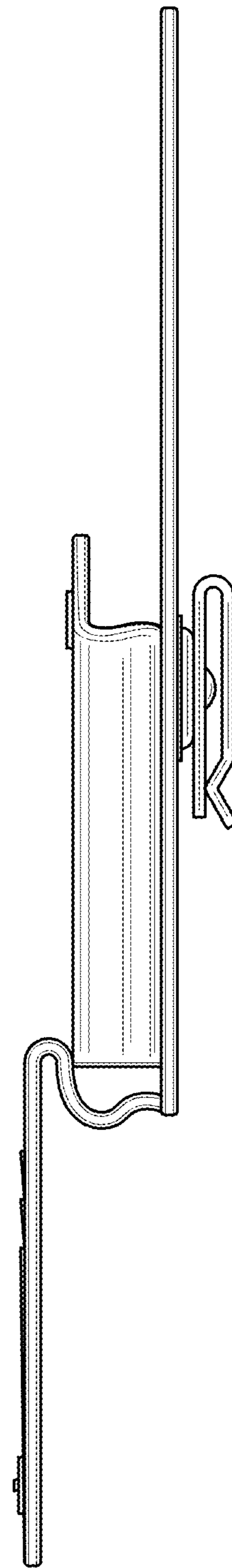

FIG. 7