



US00D887097S

(12) **United States Design Patent**
 Holding et al.

(10) **Patent No.:** **US D887,097 S**
(45) **Date of Patent:** **** Jun. 9, 2020**

(54) **VESSEL FOR WASHING AND STORAGE**

(71) Applicant: **Joseph Joseph Ltd.**, London (GB)

(72) Inventors: **Bill Holding**, London (GB); **Ben Cox**, London (GB)

(73) Assignee: **Joseph Joseph Ltd.**, London (GB)

(**) Term: **15 Years**

(21) Appl. No.: **29/680,219**

(22) Filed: **Feb. 14, 2019**

(30) **Foreign Application Priority Data**

Aug. 17, 2018 (EM) 005612116

(51) **LOC (12) Cl.** **07-05**

(52) **U.S. Cl.**
USPC **D32/54**

(58) **Field of Classification Search**
USPC D32/37, 53, 53.1, 54; D3/304, 307, 315,
D3/905; D23/284, 288, 290; D7/603;
D21/532
CPC B44D 3/123; B44D 3/128; B44D 3/12;
B44D 3/126; B44D 3/127; B65D
2543/00092
See application file for complete search history.

(56) **References Cited**

U.S. PATENT DOCUMENTS

D351,997 S * 11/1994 Finnah D9/425
D482,830 S * 11/2003 Kohn D32/53.1
D603,484 S * 11/2009 Eilmus D23/290
D703,897 S * 4/2014 Holding D32/53

OTHER PUBLICATIONS

Bed Bath & Beyond, Joseph Joseph wash and drain dish pan, online product page dated Sep. 2, 2016, retrieved Jan. 23, 2020 from

<URL:https://web.archive.org/web/20160902010834/https://www.bedbathandbeyond.com/store/product/joseph-joseph-reg-wash-and-drain-dish-pan/3243776> (Year: 2016).*
Target.com, Plastic dish rack tub, undated online product page, retrieved Jan. 23, 2020 from <URL:https://www.target.com/p/plastic-dish-rack-tub-umbra/-/A-54570014> (Year: 2020).*
Remodelista, A. Hotz, 10 easy pieces: space-saving dish rack for small kitchens, blog post dated Aug. 13, 2012, noted for Tower Dish Drainer from Yamazaki, retrieved Jan. 23, 2020 from <URL:https://www remodelista.com/posts/kitchen-space-saving-dish-racks/> (Year: 2012).*

* cited by examiner

Primary Examiner — Sheryl Lane

Assistant Examiner — Calvin E Vansant

(74) *Attorney, Agent, or Firm* — Millen, White, Zelano & Branigan, PC; Ryan Pool

(57) **CLAIM**

The ornamental design for a vessel for washing and storage, as shown and described.

DESCRIPTION

FIG. 1 is a side view of the vessel for washing and storage showing my new design.
FIG. 2 is another side view thereof.
FIG. 3 is another side view thereof.
FIG. 4 is another side view thereof.
FIG. 5 is a top view thereof.
FIG. 6 is a bottom view thereof.
FIG. 7 is a top perspective view thereof; and,
FIG. 8 is a bottom perspective view thereof.
In the drawings, the dashed broken lines depict portions of the washing and storage vessel that form no part of the claimed design. The dot-dash lines represent boundaries of the claim and form no part of the claim.

1 Claim, 8 Drawing Sheets

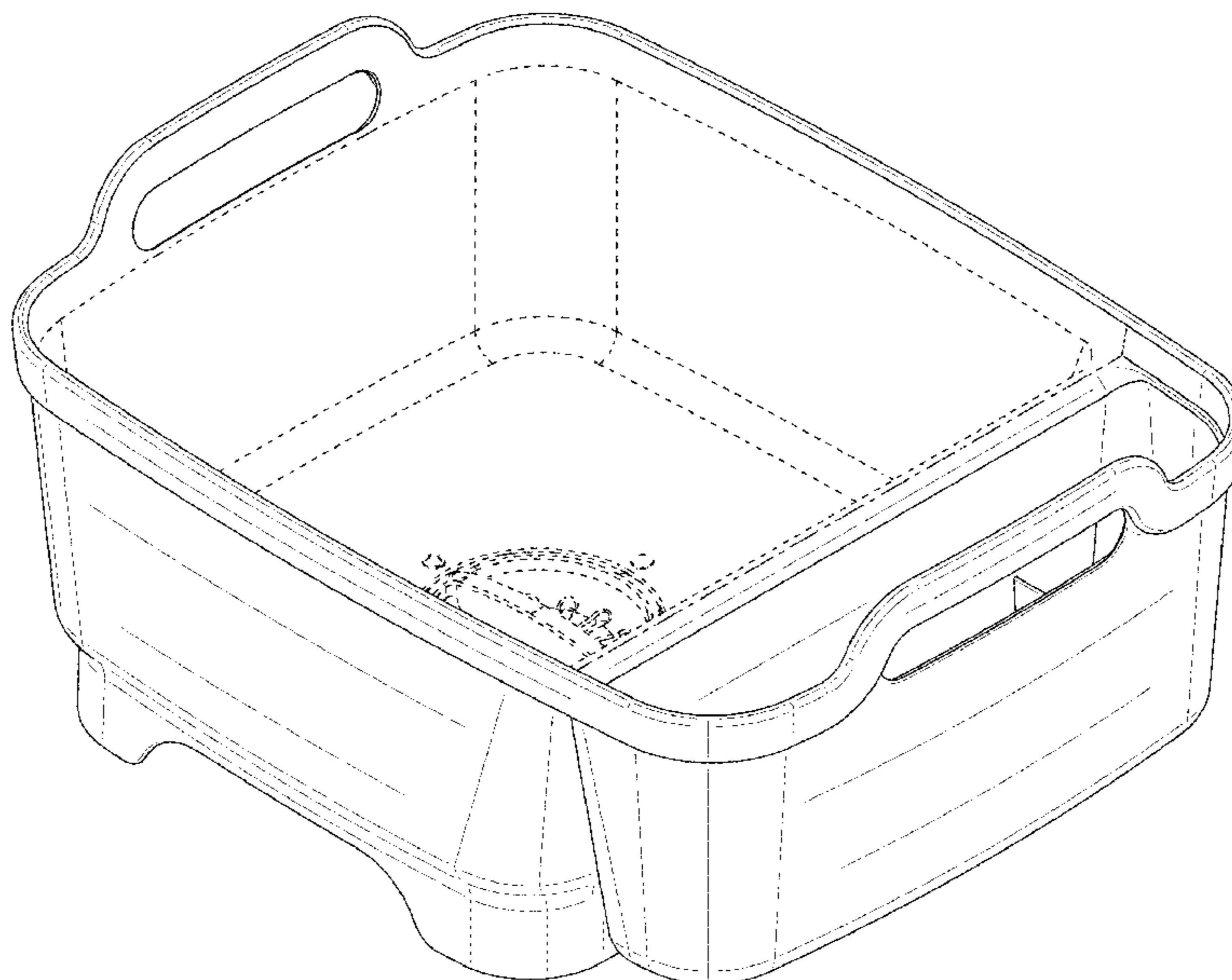

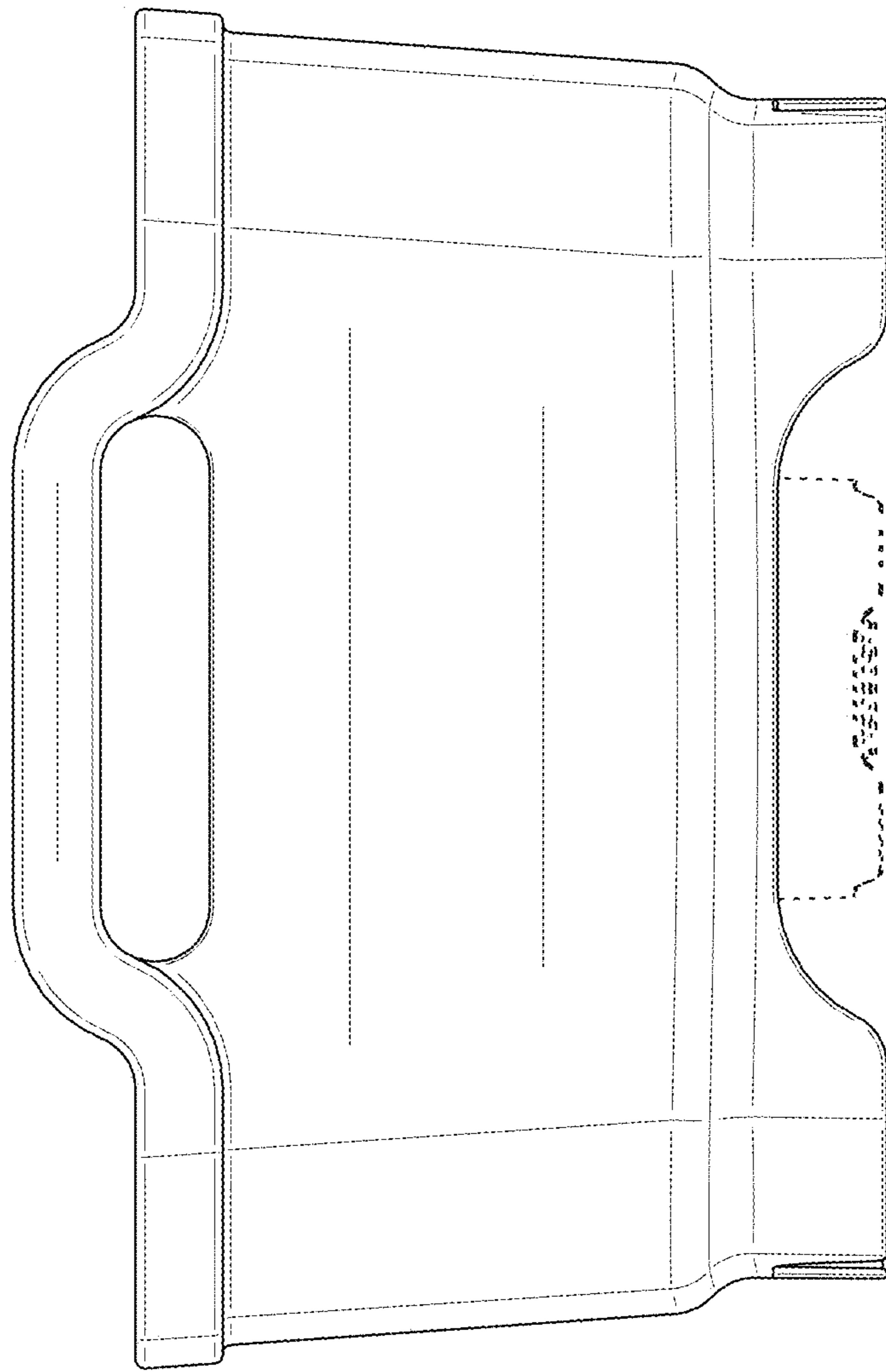

Fig. 1

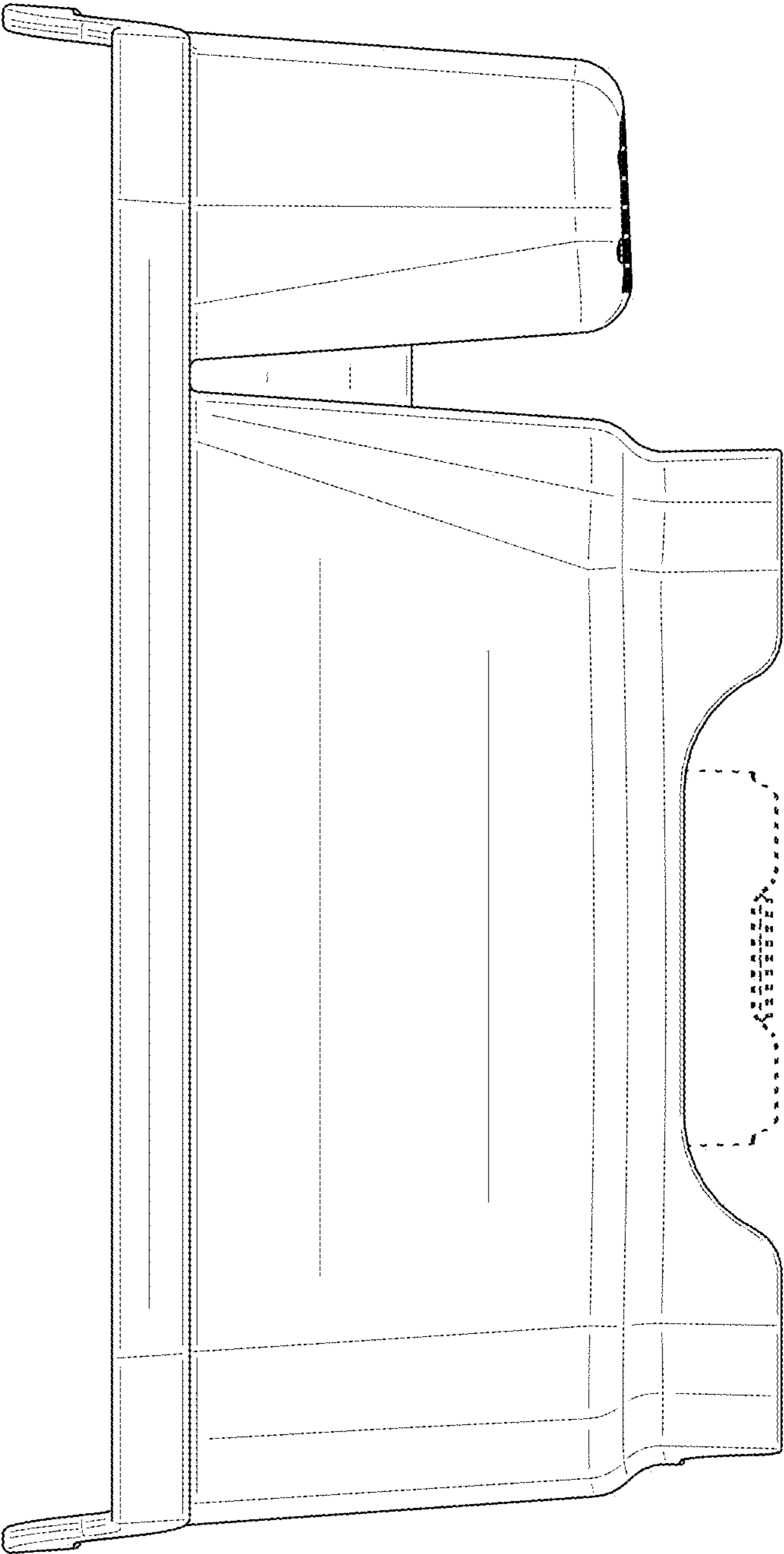

Fig. 2

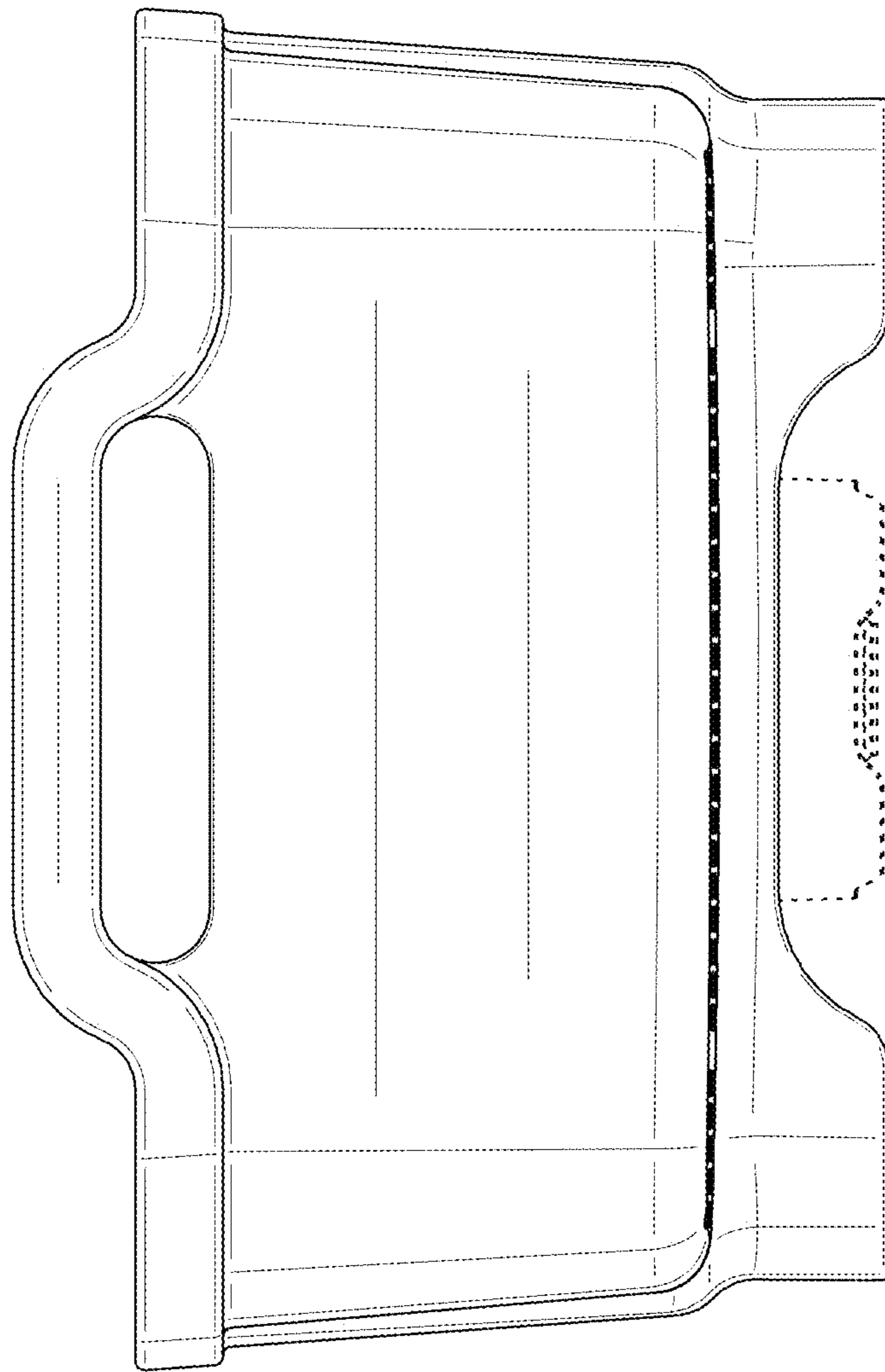

Fig. 3

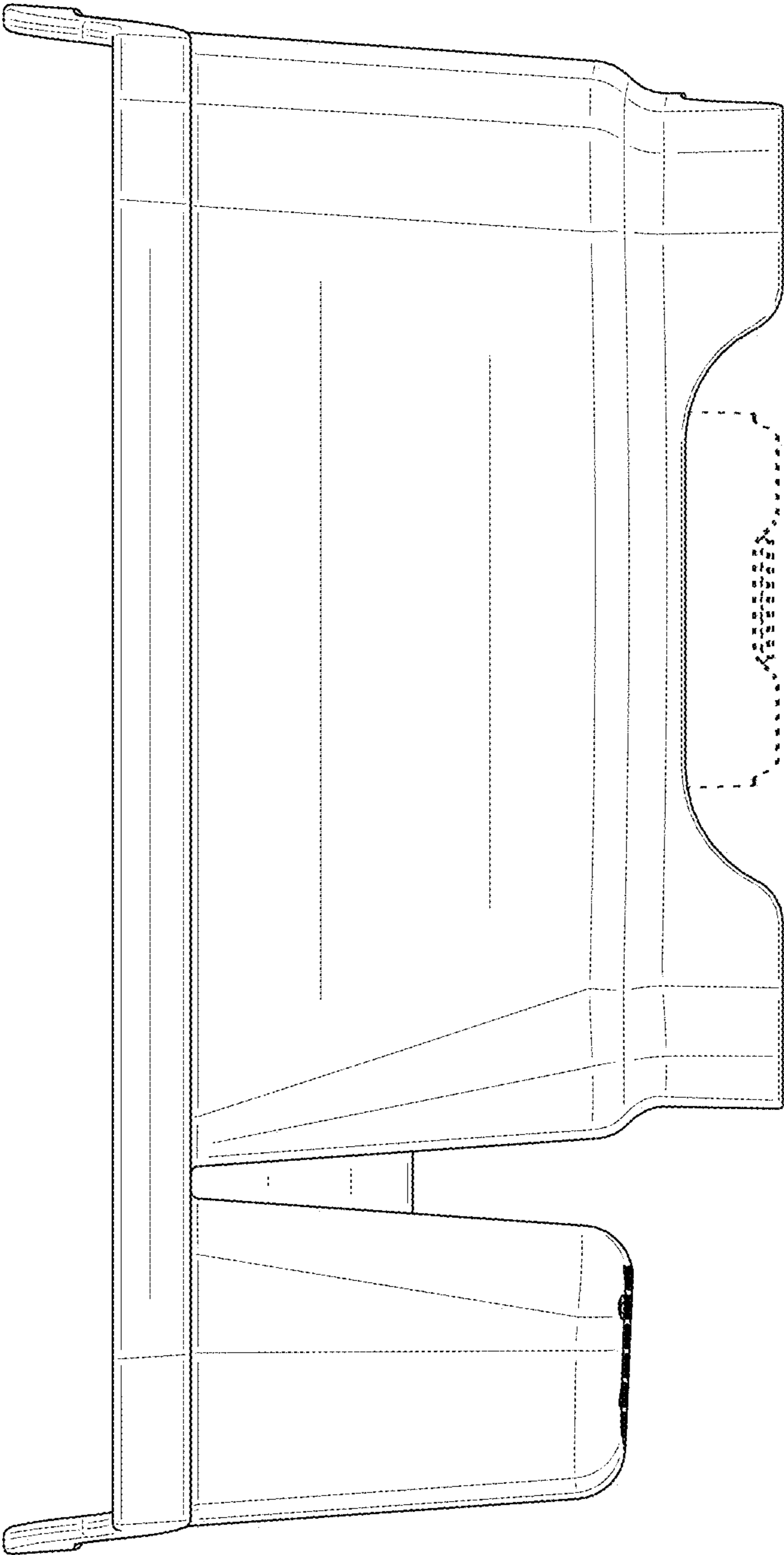

Fig. 4

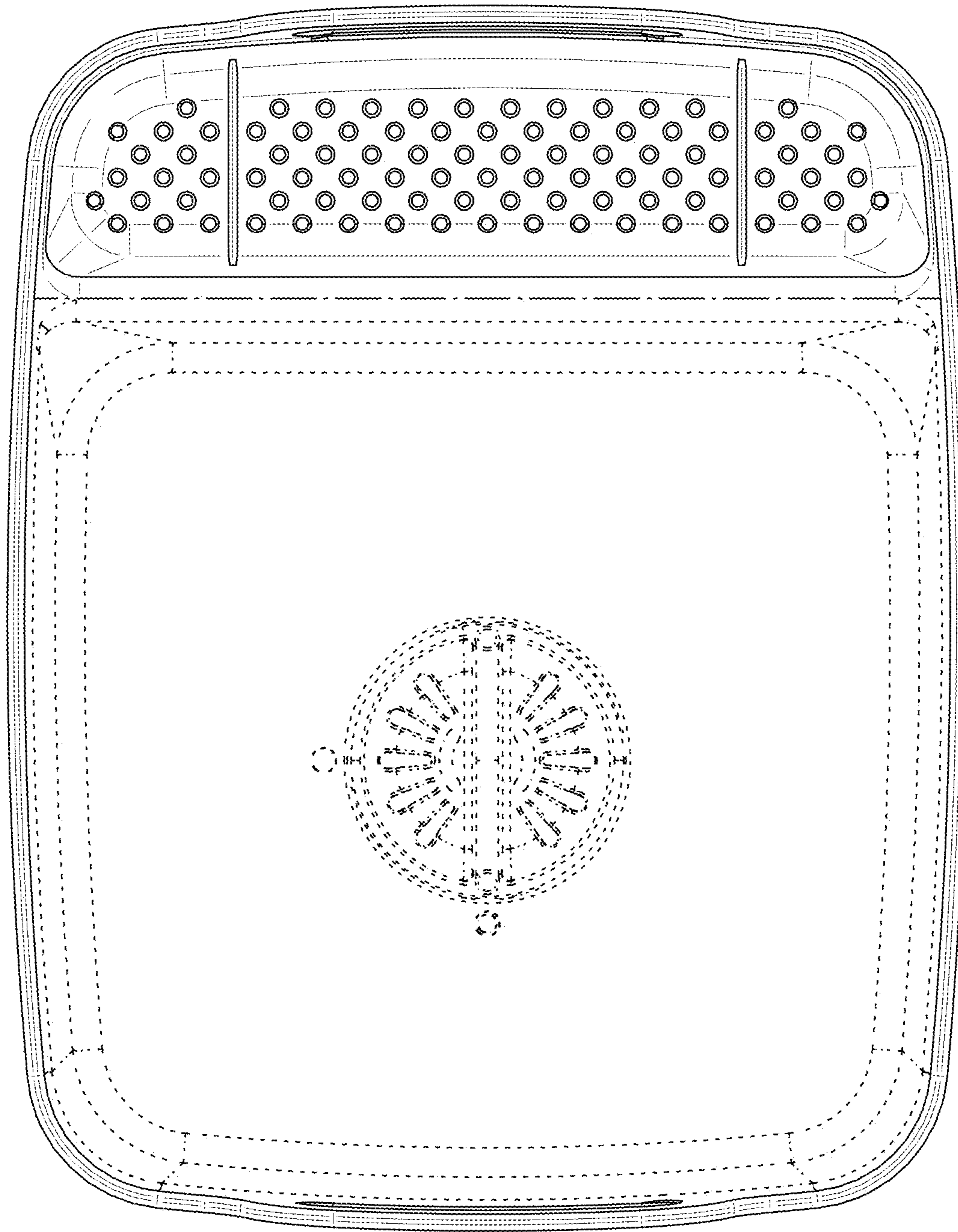

Fig. 5

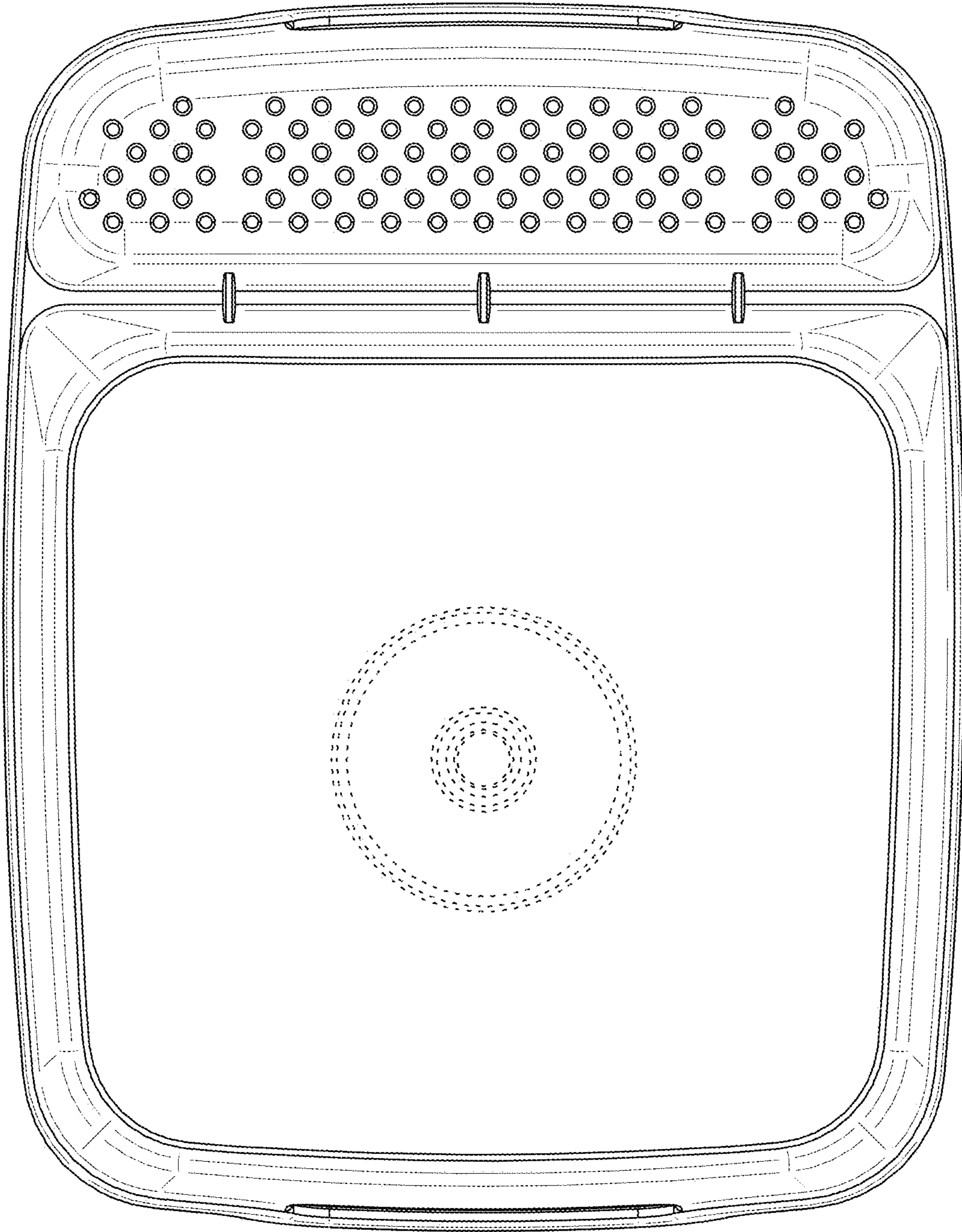

Fig. 6

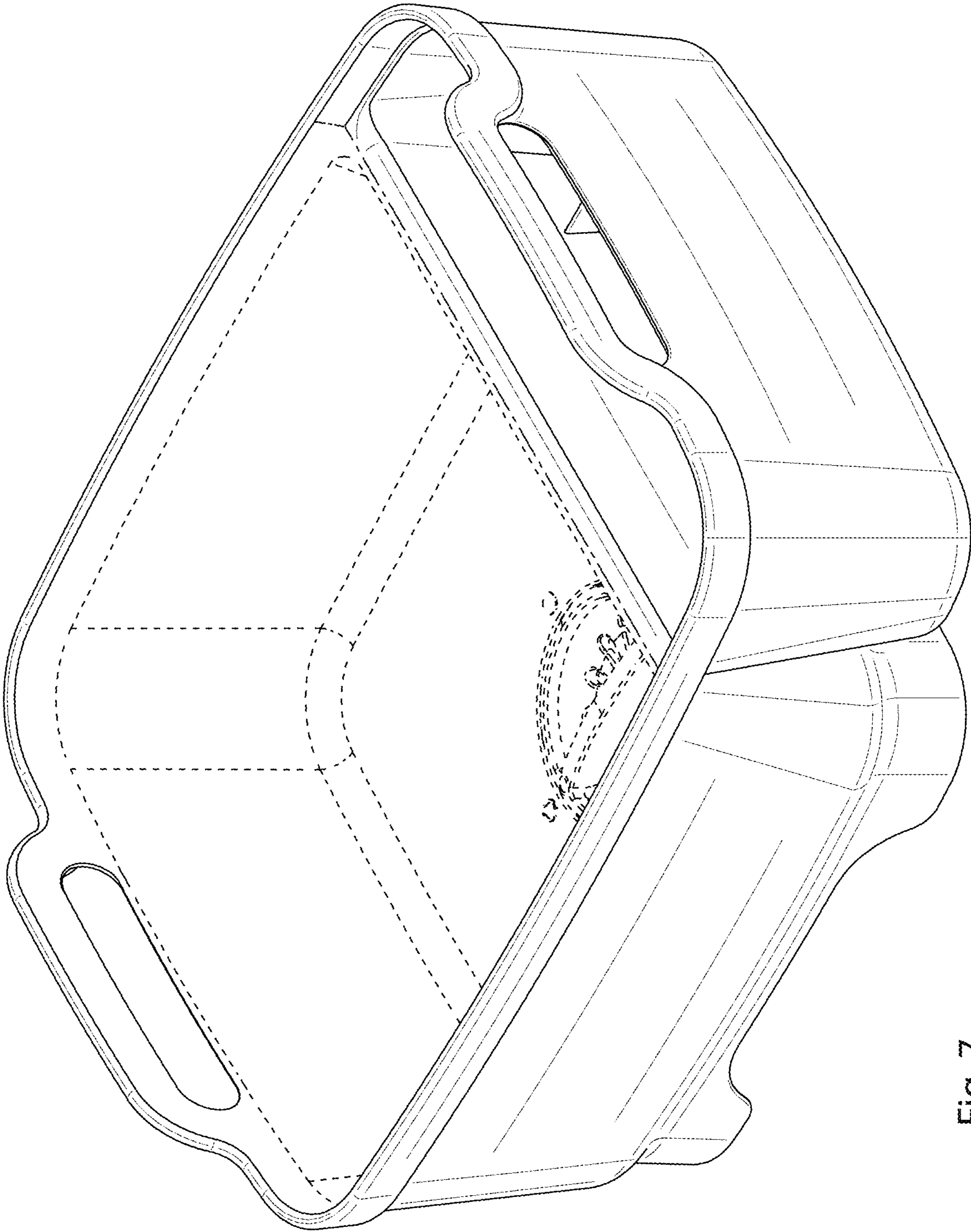

Fig. 7

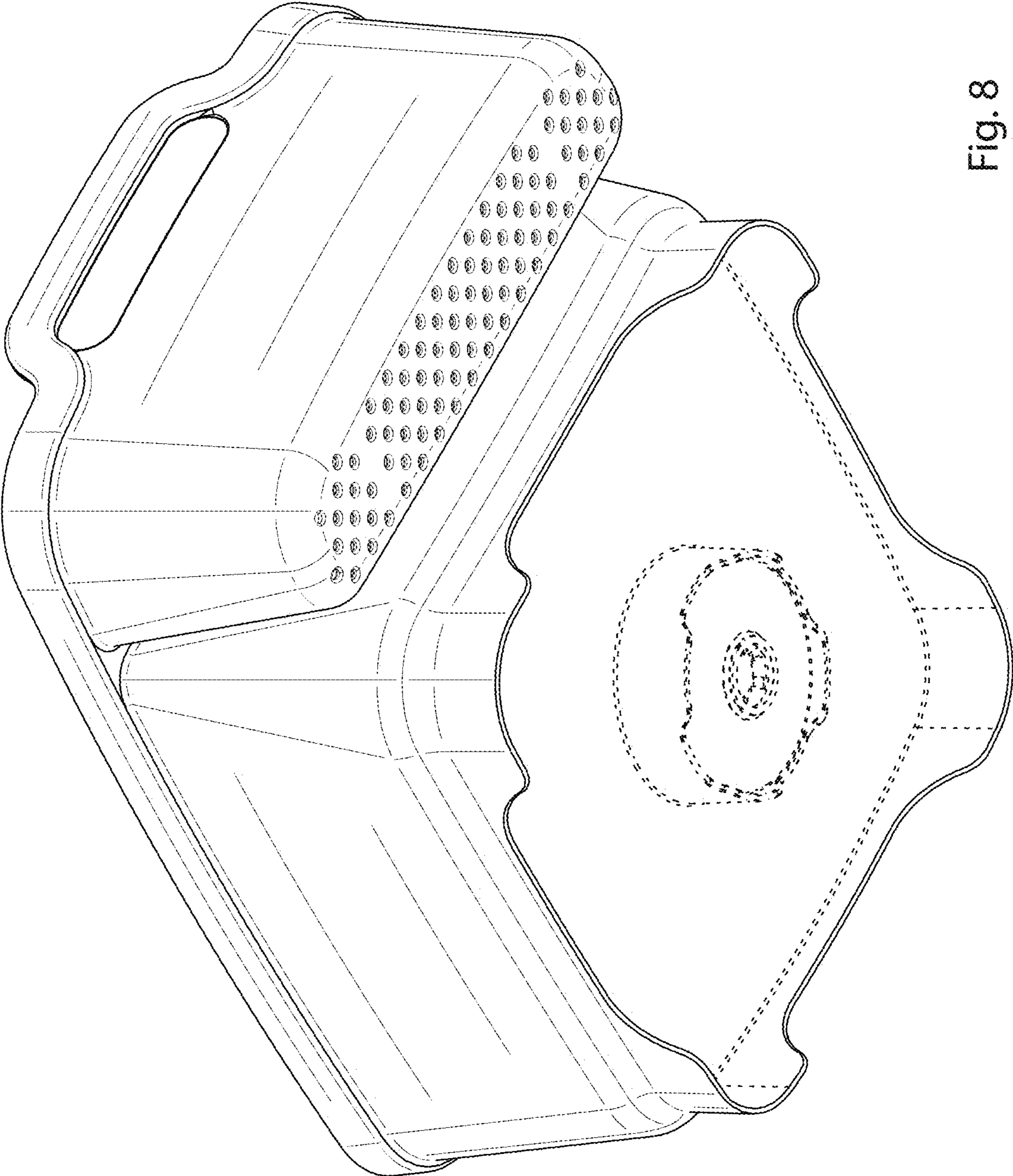

Fig. 8