



US00D886962S

(12) **United States Design Patent** (10) **Patent No.:** **US D886,962 S**
Kobayashi et al. (45) **Date of Patent:** **** Jun. 9, 2020**

(54) **WASHBASIN**
 (71) Applicant: **LIXIL Corporation**, Tokyo (JP)
 (72) Inventors: **Hiroshi Kobayashi**, Tokyo (JP);
Kanoko Misawa, Tokyo (JP)

D585,127 S 1/2009 Thalmann Gomez et al.
 D588,244 S 3/2009 Lee et al.
 D592,292 S 5/2009 Kakihana et al.
 D745,122 S 12/2015 Schonherr et al.
 D811,561 S 2/2018 Yoshioka et al.
 D815,260 S 4/2018 Moller et al.

(73) Assignee: **LIXIL Corporation**, Tokyo (JP)
 (**) Term: **15 Years**

OTHER PUBLICATIONS

Ceramica Cielo S.p.A., Web Page <<http://www.ceramicacielo.it/ita/tech/easy.php?cod=EASLA80>>, Published Jan. 7, 2011 to Jan. 14, 2011, 1 page; webpage cited at p. 4 of Japanese Patent Office Action in counterpart application No. 2018-011310.

(21) Appl. No.: **29/719,353**

Primary Examiner — Robert A Delehanty

(22) Filed: **Jan. 3, 2020**

(74) *Attorney, Agent, or Firm* — Sughrue Mion, PLLC

Related U.S. Application Data

(62) Division of application No. 29/670,809, filed on Nov. 20, 2018.

(57) **CLAIM**

The ornamental design for a washbasin, as shown and described.

(30) **Foreign Application Priority Data**

May 23, 2018 (JP) 2018-011306
 May 23, 2018 (JP) 2018-011307
 May 23, 2018 (JP) 2018-011308
 May 23, 2018 (JP) 2018-011309

DESCRIPTION

FIG. 1 is a perspective view of a washbasin.
 FIG. 2 is a top plan view thereof.
 FIG. 3 is a bottom plan view thereof.
 FIG. 4 is a front elevation view thereof.
 FIG. 5 is a rear elevation view thereof.
 FIG. 6 is a right side elevation view thereof.
 FIG. 7 is a left side elevation view thereof.
 FIG. 8 is a cross-sectional view taken along the line 8-8 in FIG. 4; and,
 FIG. 9 is a cross-sectional view taken along the line 9-9 in FIG. 2.
 The dark portions in cross-sectional FIGS. 8 and 9 form no part of the claimed design.

(51) **LOC (12) Cl.** **23-02**

(52) **U.S. Cl.**
USPC **D23/284**

(58) **Field of Classification Search**
USPC D23/284, 293.1, 308, 285–292
See application file for complete search history.

(56) **References Cited**

U.S. PATENT DOCUMENTS

D560,780 S 1/2008 Hanna
 D563,535 S 5/2008 Kergoet

1 Claim, 9 Drawing Sheets

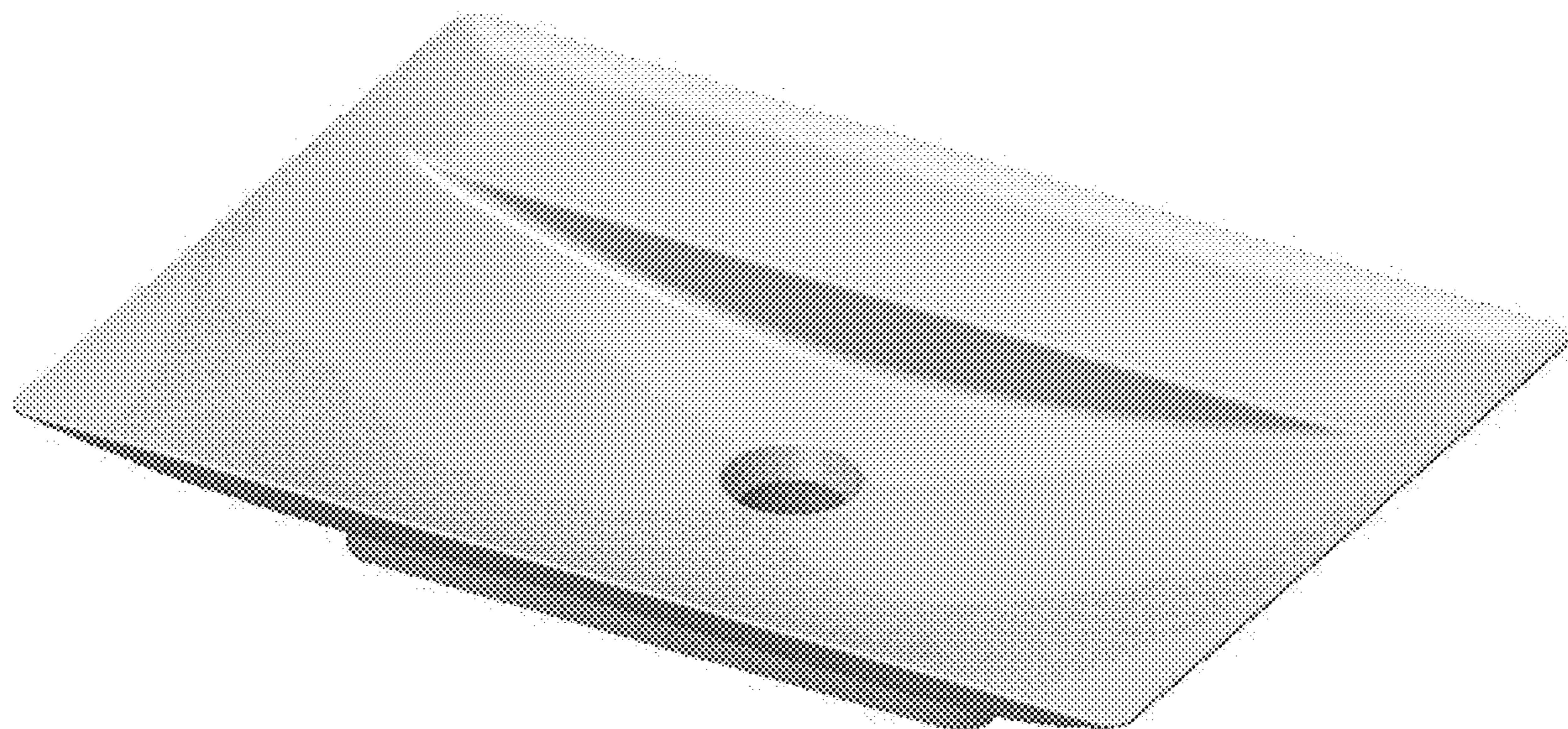

FIG. 1

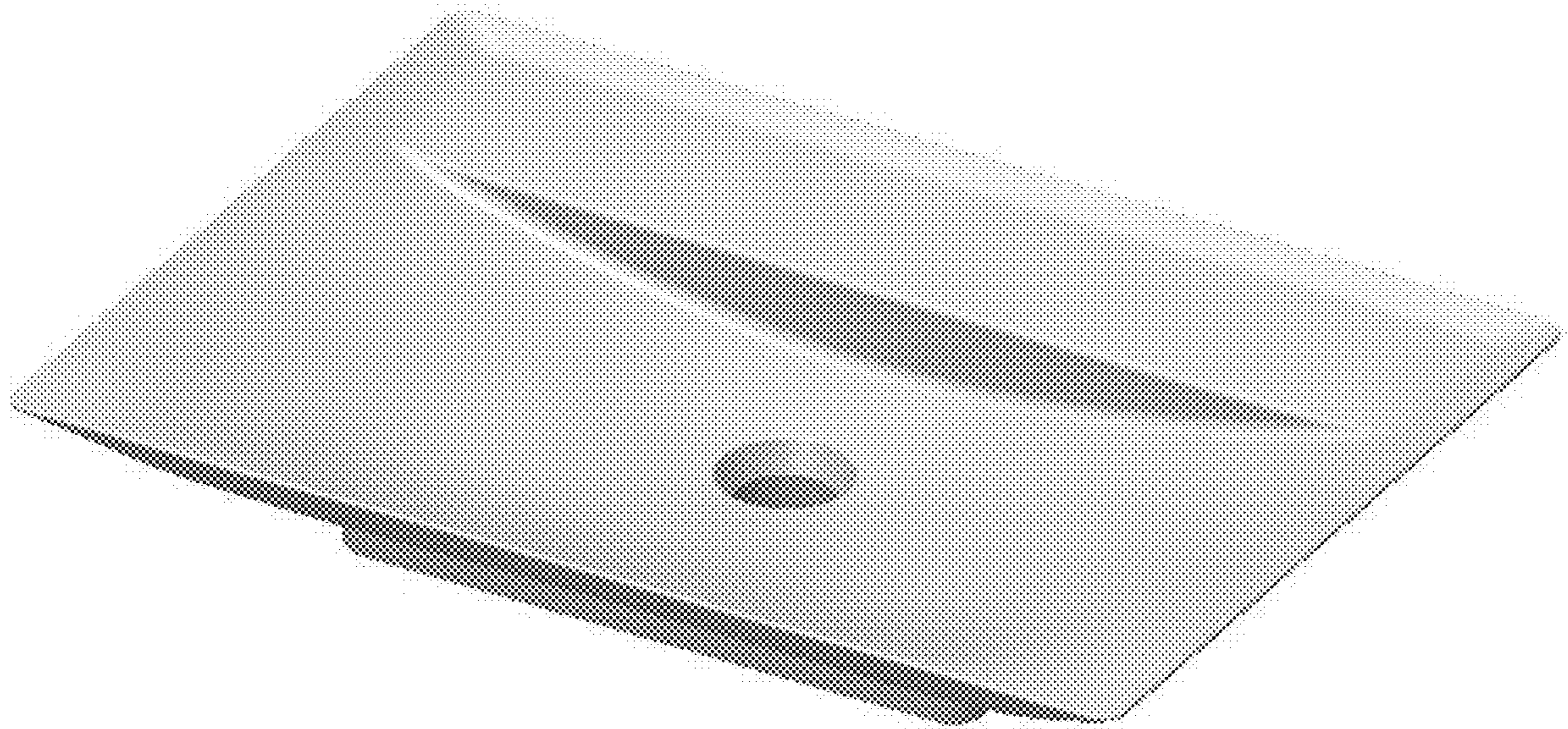

FIG. 2



FIG. 3

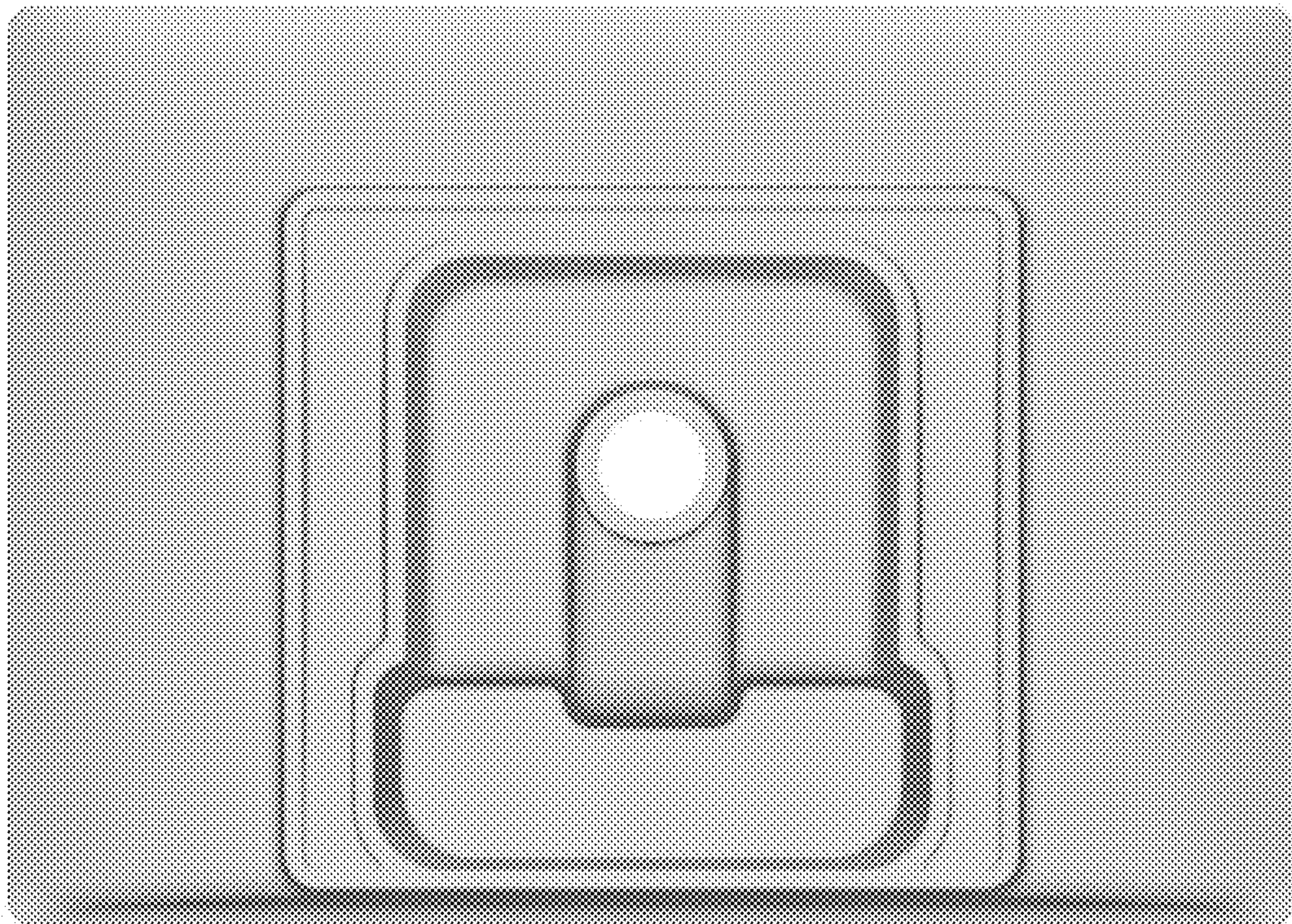

FIG. 4

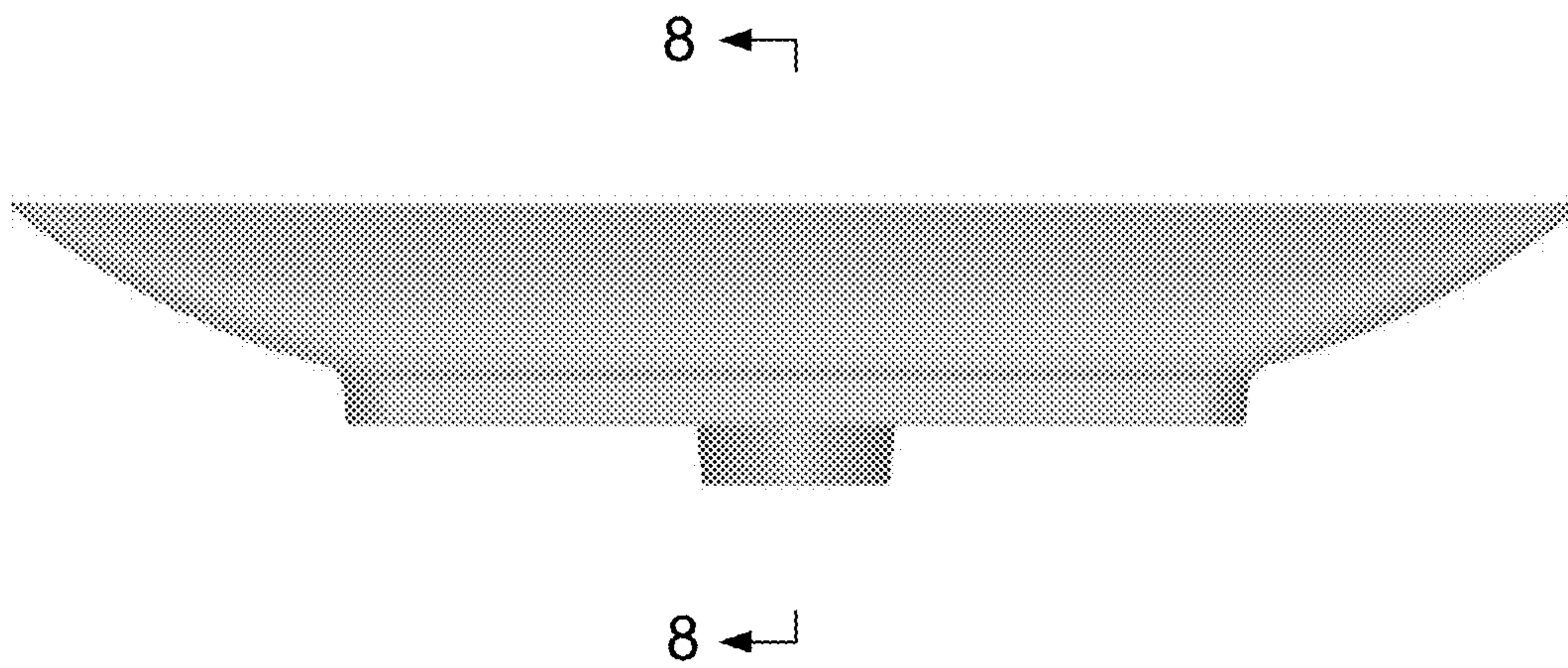

FIG. 5

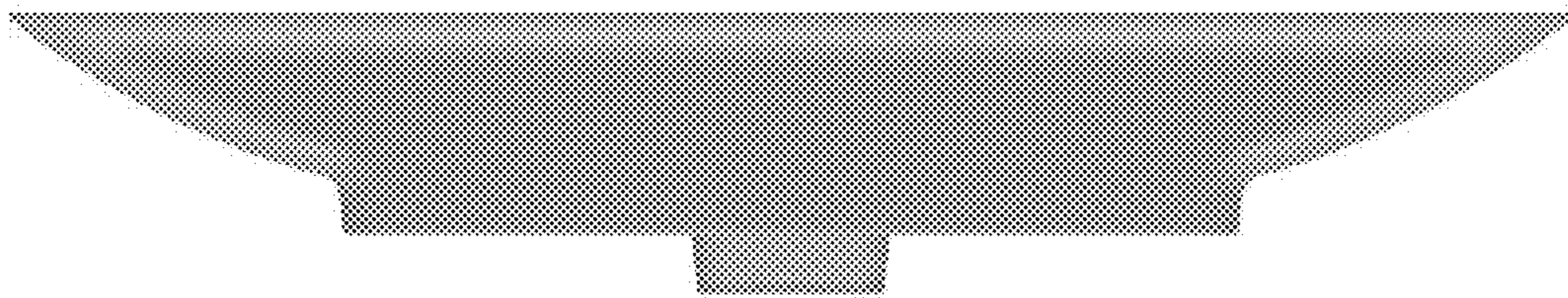

FIG. 6

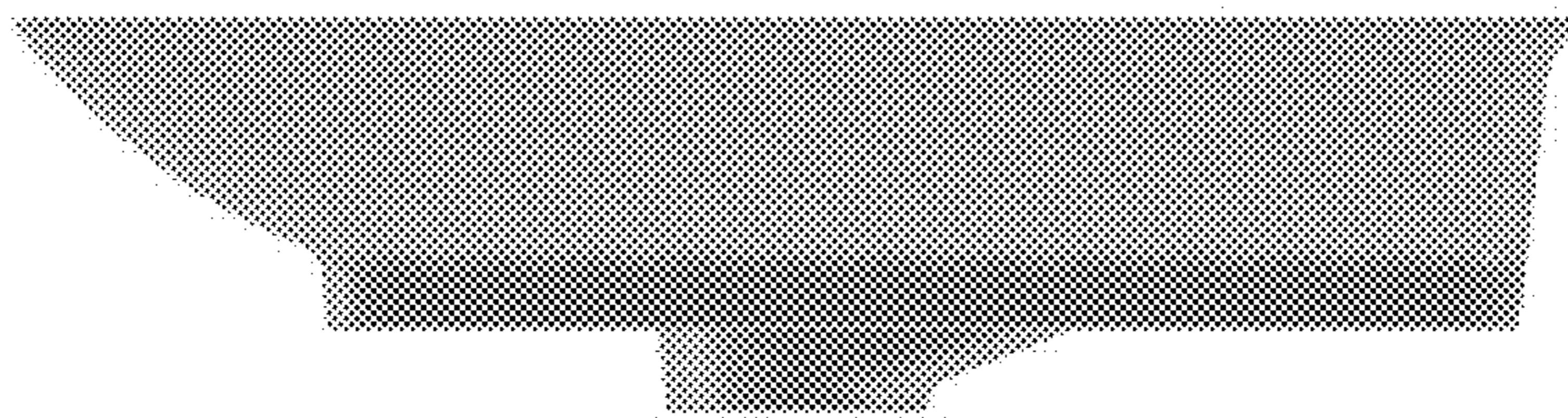

FIG. 7

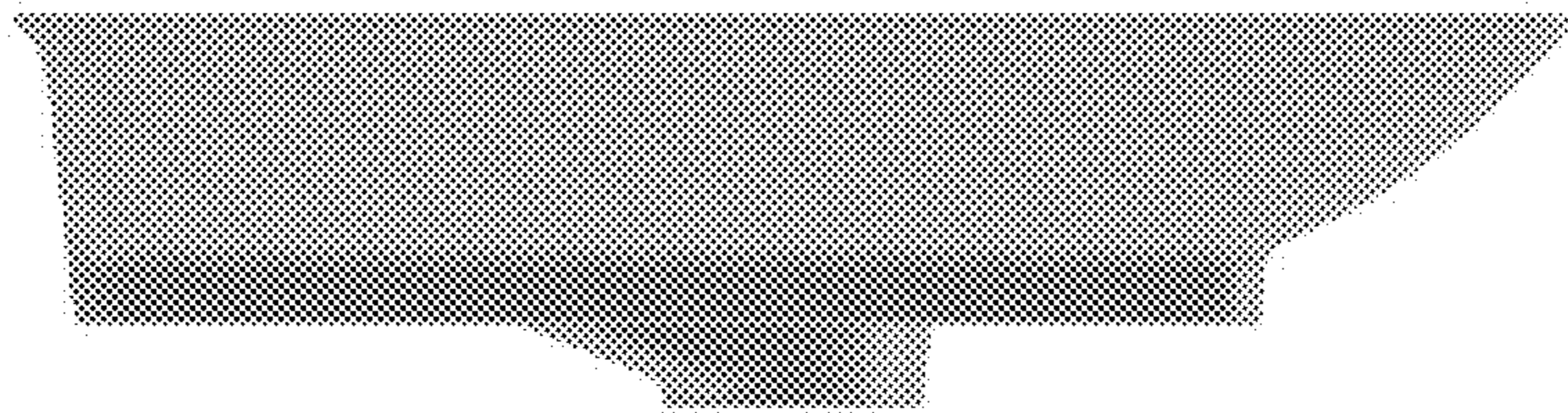

FIG. 8

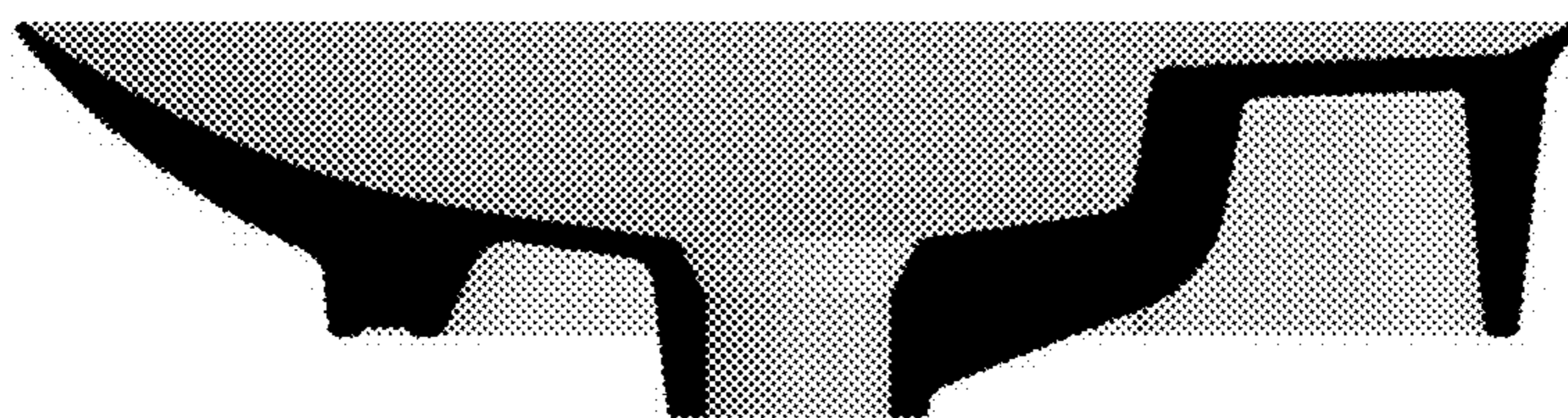

FIG. 9

