



US00D886913S

(12) **United States Design Patent**  
**Hama et al.**

(10) **Patent No.:** **US D886,913 S**  
(45) **Date of Patent:** **\*\* Jun. 9, 2020**

(54) **ACCESSORY FOR SPINNING TOP TOY**  
(71) Applicant: **TOMY COMPANY, LTD.**, Tokyo (JP)  
(72) Inventors: **Hiroyuki Hama**, Tokyo (JP); **Asami Oba**, Tokyo (JP); **Toshinobu Ishii**, Saitama (JP)  
(73) Assignee: **TOMY COMPANY, LTD.**, Tokyo (JP)  
(\*\*) Term: **15 Years**  
(21) Appl. No.: **29/684,506**  
(22) Filed: **Mar. 21, 2019**

(30) **Foreign Application Priority Data**  
Sep. 27, 2018 (JP) ..... 2018-021003  
(51) **LOC (12) Cl.** ..... **21-01**  
(52) **U.S. Cl.**  
USPC ..... **D21/460**  
(58) **Field of Classification Search**  
USPC ..... D21/455-464; 446/236-266  
CPC ..... A63H 1/00-32  
See application file for complete search history.

(56) **References Cited**  
**U.S. PATENT DOCUMENTS**  
D825,671 S \* 8/2018 Horikoshi ..... D21/460  
D827,044 S \* 8/2018 Horikoshi ..... D21/460  
D834,102 S \* 11/2018 Muraki ..... D21/460  
D834,103 S \* 11/2018 Horikoshi ..... D21/460  
D844,069 S \* 3/2019 Horikawa ..... D21/460  
D845,396 S \* 4/2019 Horikoshi ..... D21/460  
D851,709 S \* 6/2019 Muraki ..... D21/460  
D852,280 S \* 6/2019 Horikoshi ..... D21/460  
D854,095 S \* 7/2019 Narita ..... D21/460  
D854,096 S \* 7/2019 Muraki ..... D21/460

D854,097 S \* 7/2019 Muraki ..... D21/460  
D854,626 S \* 7/2019 Horikoshi ..... D21/460  
D855,119 S \* 7/2019 Saito ..... D21/460  
D857,109 S \* 8/2019 Muraki ..... D21/460  
D861,079 S \* 9/2019 Matsukawa ..... D21/460  
D862,606 S \* 10/2019 Horikoshi ..... D21/460  
D862,608 S \* 10/2019 Yamasaki ..... D21/460  
D866,677 S \* 11/2019 Horikoshi ..... D21/460

**FOREIGN PATENT DOCUMENTS**

JP 6431629 B1 \* 11/2018 ..... A63H 1/02  
\* cited by examiner

*Primary Examiner* — Catherine A Tuttle  
(74) *Attorney, Agent, or Firm* — Oliff PLC

(57) **CLAIM**

The ornamental design for an accessory for spinning top toy, as shown and described.

**DESCRIPTION**

FIG. 1 is a front elevational view of the accessory for spinning top toy;  
FIG. 2 is a left elevational view thereof;  
FIG. 3 is a rear-side elevational view thereof;  
FIG. 4 is a right-side elevational view thereof;  
FIG. 5 is a top plan view thereof;  
FIG. 6 is a bottom plan view thereof;  
FIG. 7 is a front, top and right side perspective view thereof;  
FIG. 8 is a rear, bottom and left side perspective view thereof;  
FIG. 9 is a disassembled front, top and right side perspective view thereof; and,  
FIG. 10 is a disassembled rear, bottom and left side perspective view thereof.

**1 Claim, 10 Drawing Sheets**

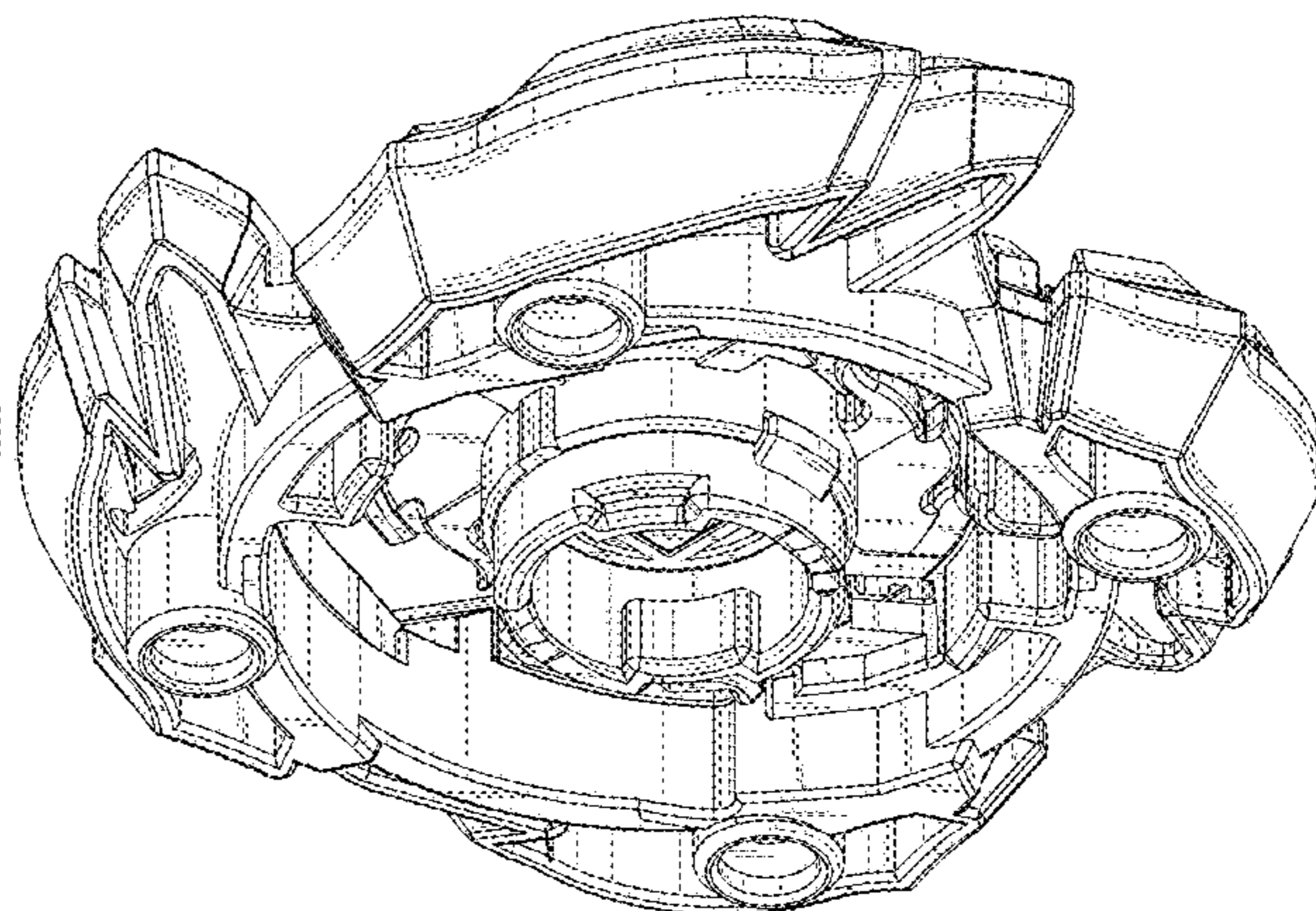
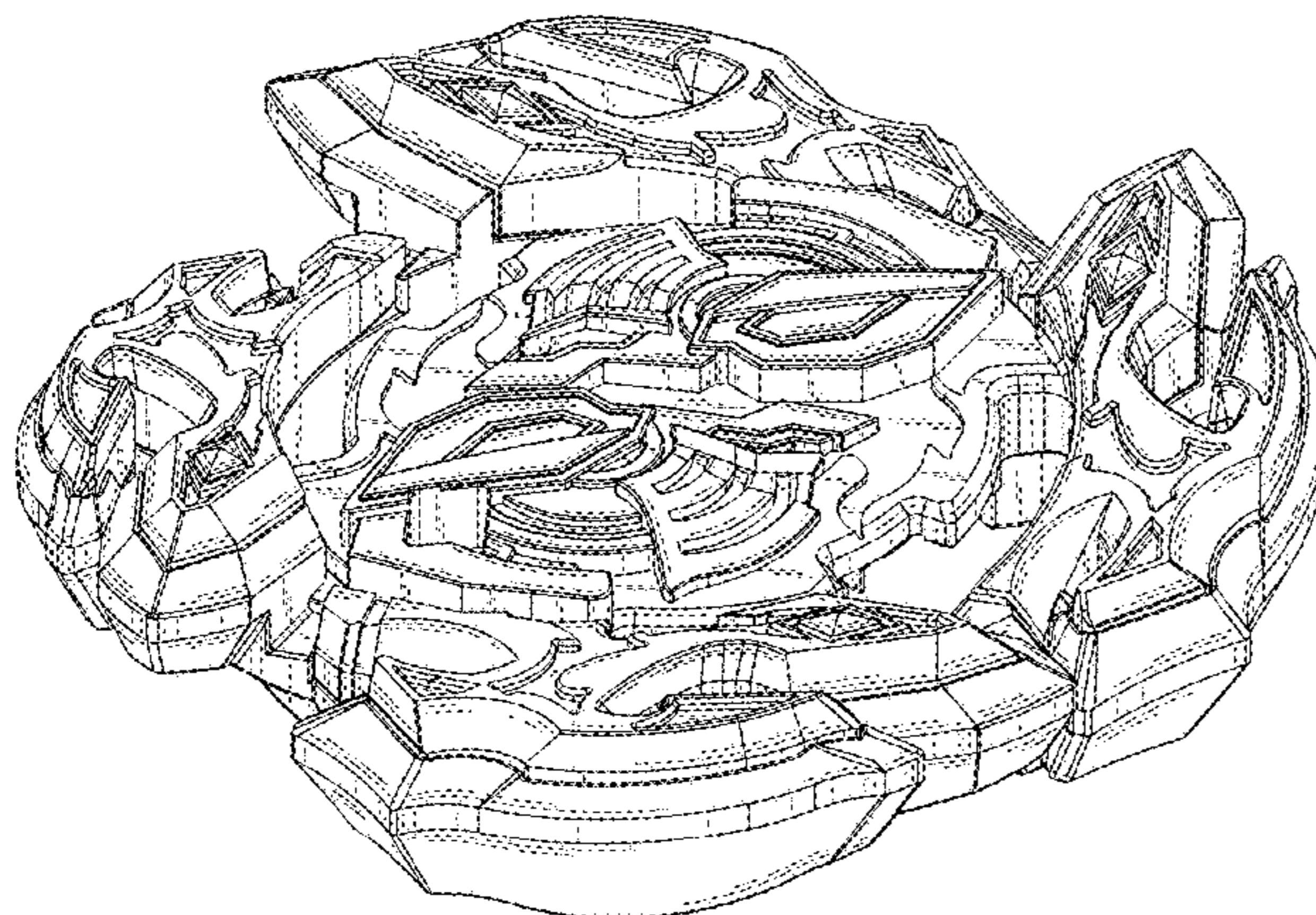

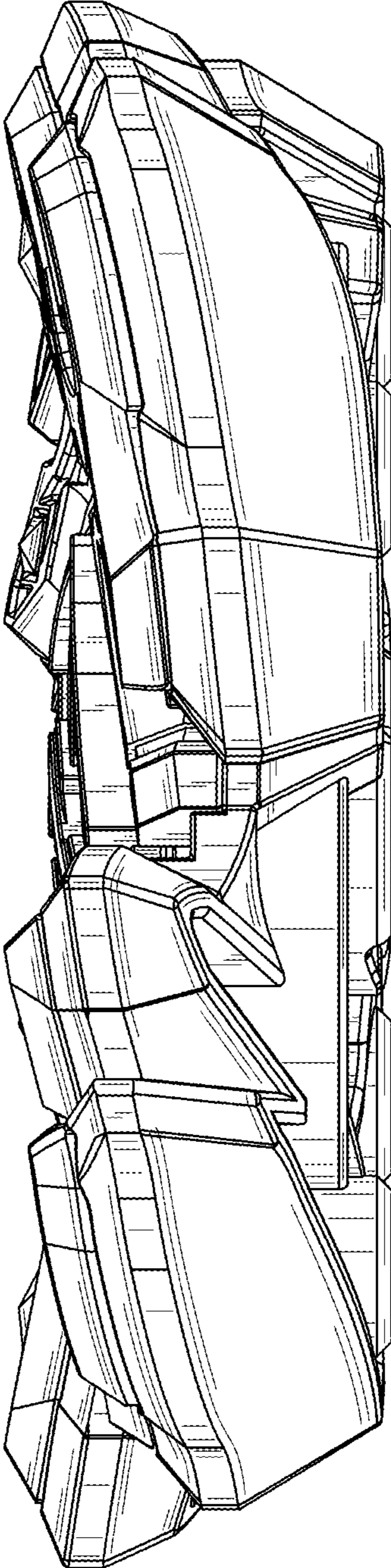

FIG.1



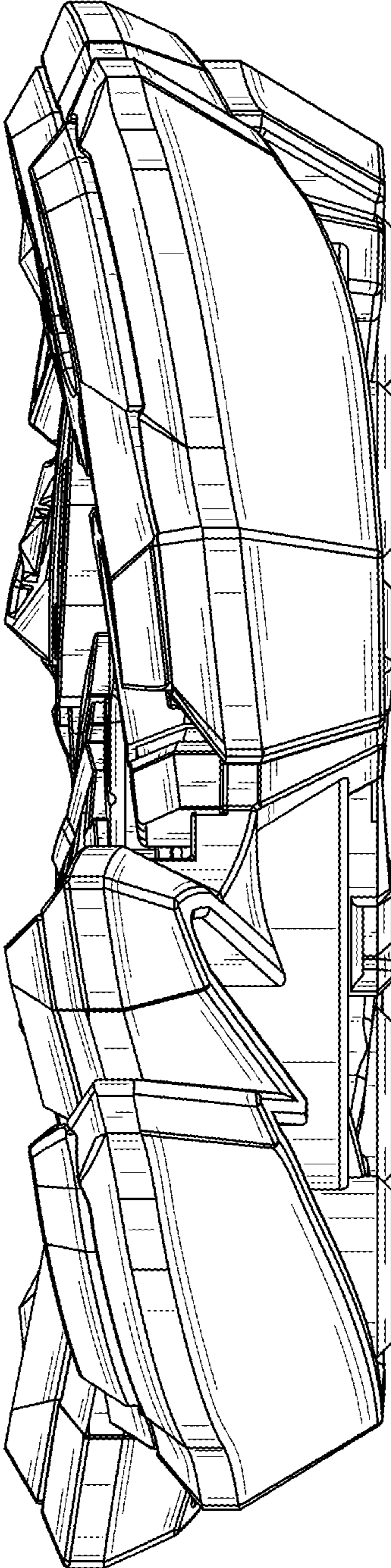

FIG.2

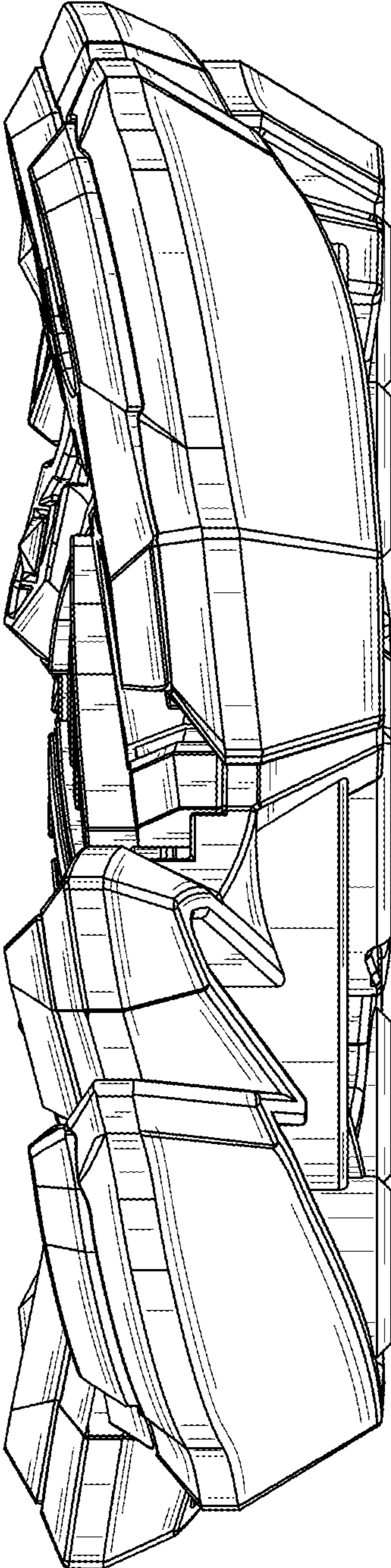

FIG.3

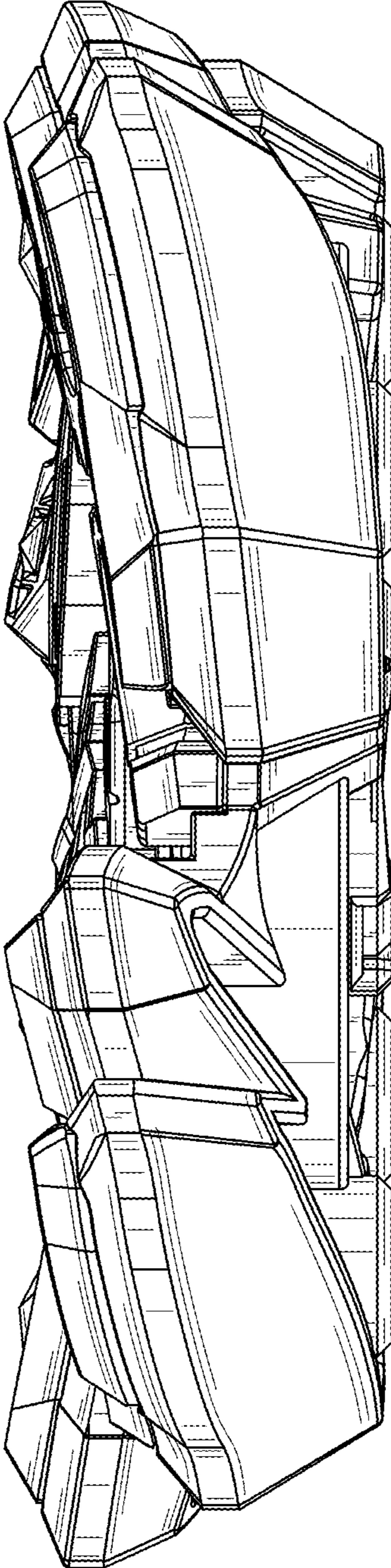

FIG.4



FIG.5

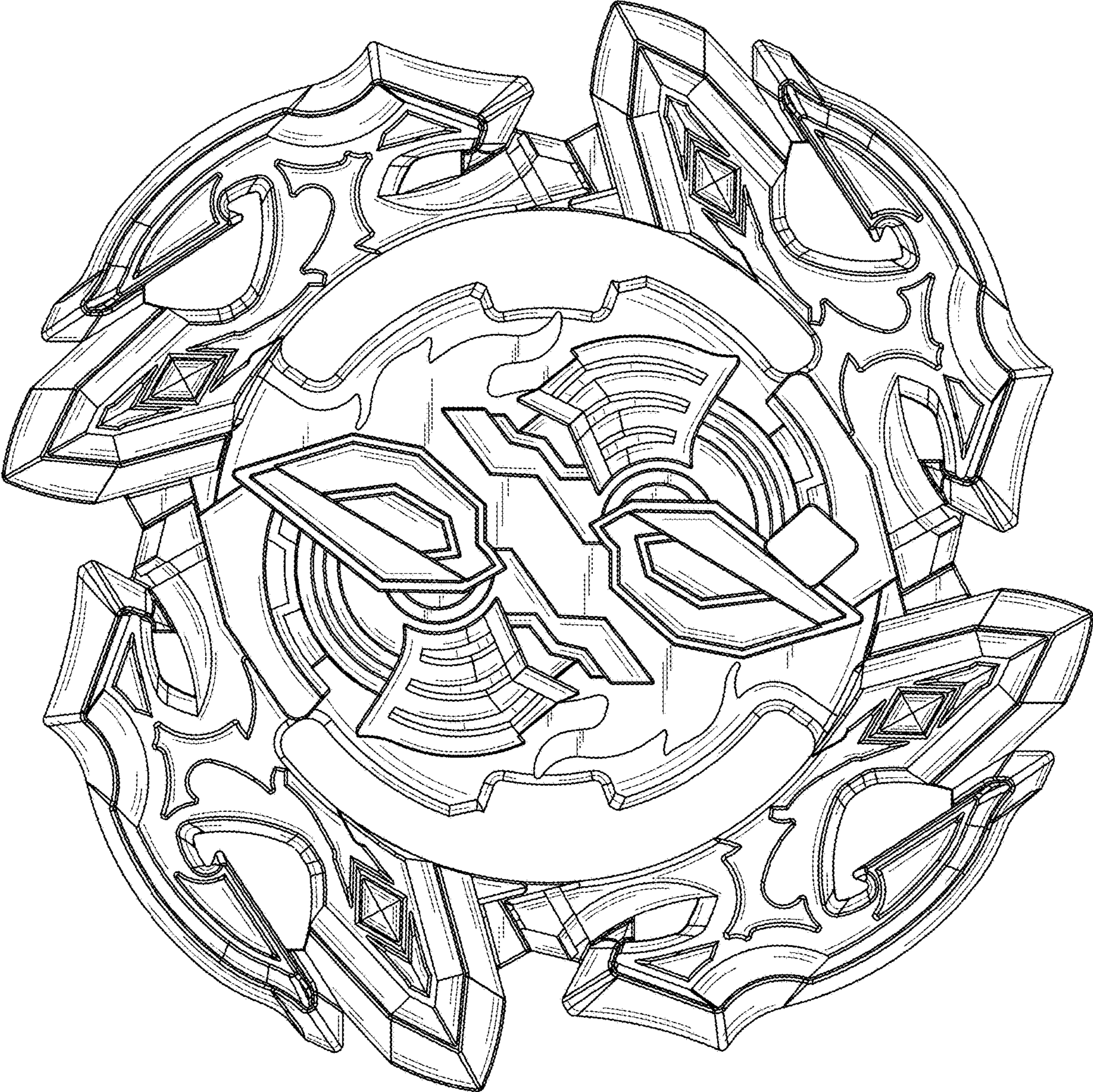
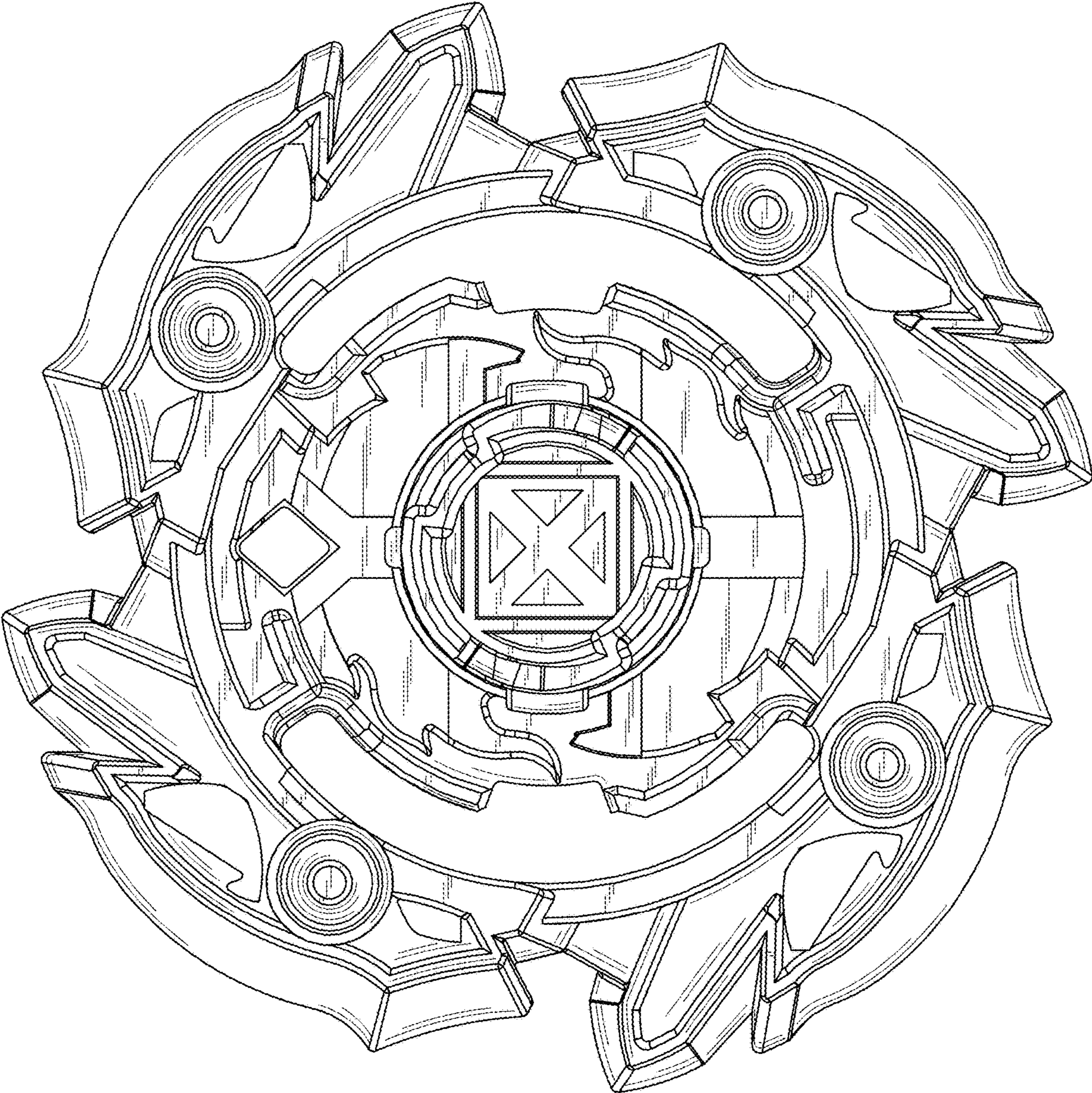



FIG.6





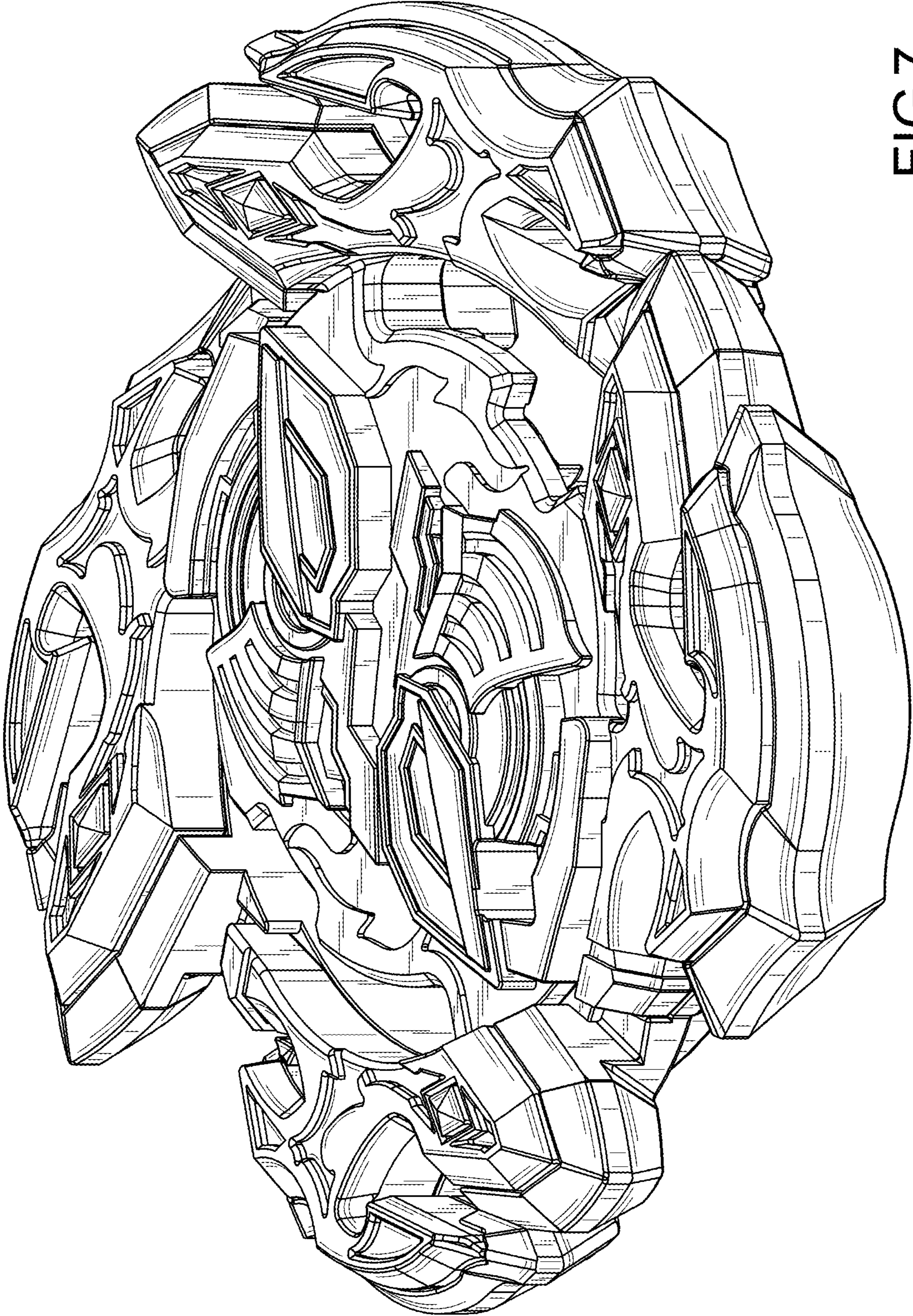

FIG.7



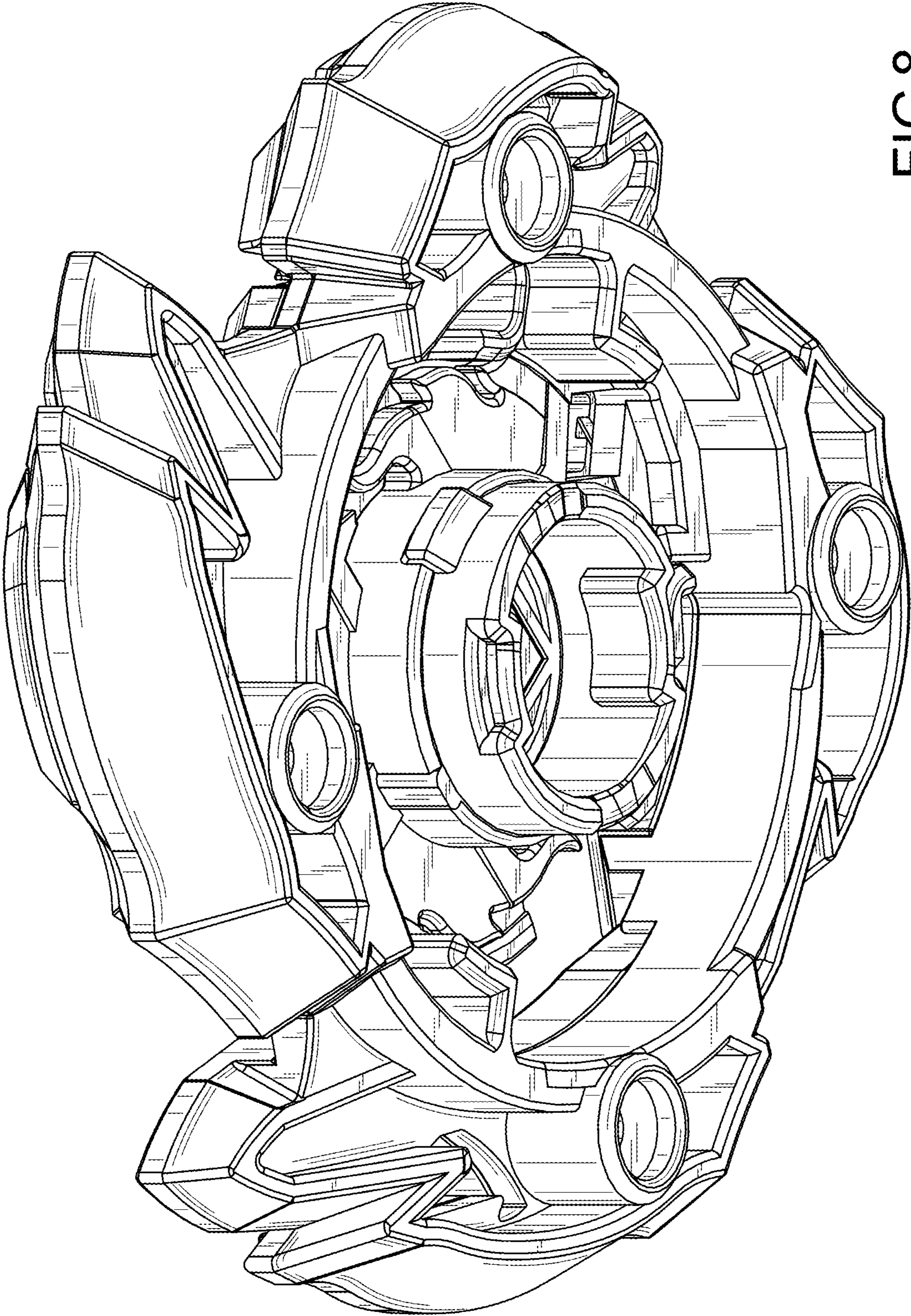

FIG.8



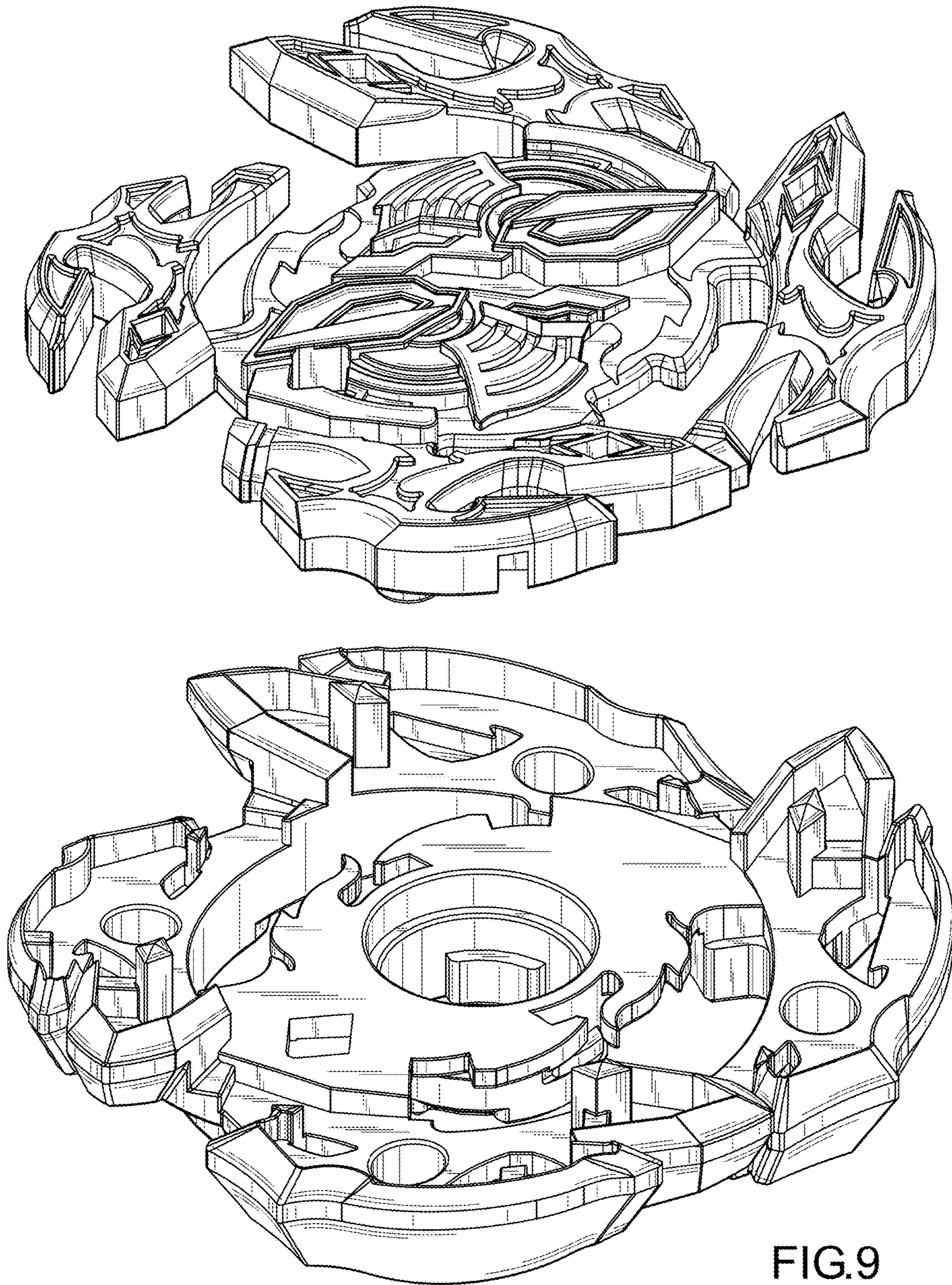

FIG.9



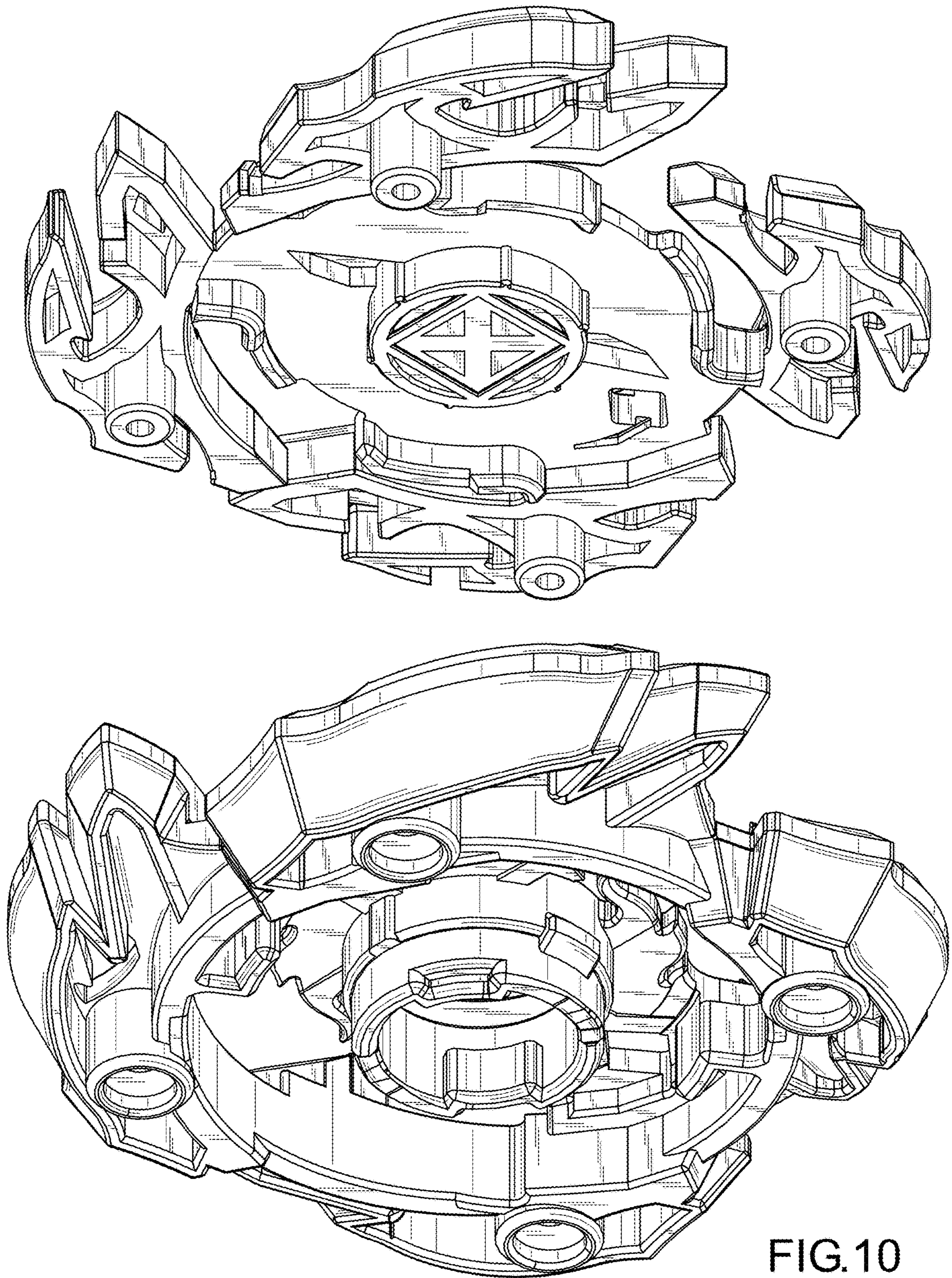

FIG. 10