



US00D886830S

(12) **United States Design Patent**
Suzuki

(10) **Patent No.:** **US D886,830 S**
(45) **Date of Patent:** **** Jun. 9, 2020**

(54) **CASSETTE FOR A DIGITAL SLIDE SCANNER**

(71) Applicant: **HAMAMATSU PHOTONICS K.K.**,
Hamamatsu-shi, Shizuoka (JP)

(72) Inventor: **Yasumoto Suzuki**, Hamamatsu (JP)

(73) Assignee: **HAMAMATSU PHOTONICS K.K.**,
Hamamatsu-shi, Shizuoka (JP)

(**) Term: **15 Years**

(21) Appl. No.: **29/621,863**

(22) Filed: **Oct. 12, 2017**

(30) **Foreign Application Priority Data**

Apr. 13, 2017 (JP) 2017-007963

(51) **LOC (12) Cl.** **14-02**

(52) **U.S. Cl.**
USPC **D14/453**

(58) **Field of Classification Search**

USPC 2/DIG. 6; 5/417, 419-420, 465,
5/632-634; 108/43; 248/118, 118.1,
248/118.3, 118.5, 205.2, 346.01, 346.07,
248/346.1, 438, 633, 918; 273/338, 438,
273/DIG. 30; 297/218.1, 228.12, 352,
297/377, 440.1, 440.11, 440.15, 452.1,
297/452.16; 312/208.1-208.4, 223.2,
312/322; 340/710; 345/163, 173;
360/69, 97.02; 361/679.33, 679.45, 737,
(Continued)

(56) **References Cited**

U.S. PATENT DOCUMENTS

4,248,498 A * 2/1981 Georges G02B 21/26
356/244
D275,553 S * 9/1984 Emmie D8/363

(Continued)

Primary Examiner — Susan Moon Lee

(74) *Attorney, Agent, or Firm* — Faegre Drinker Biddle & Reath LLP

(57) **CLAIM**

The ornamental design for a cassette for a digital slide scanner, as shown and described.

DESCRIPTION

FIG. 1 is a front view of a cassette for a digital slide scanner of the present invention.

FIG. 2 is a rear view thereof.

FIG. 3 is a top plan view thereof.

FIG. 4 is a bottom view thereof.

FIG. 5 is a right side view thereof.

FIG. 6 is a left side view thereof.

FIG. 7 is a perspective view thereof.

FIG. 8 is an enlarged view showing a portion of FIG. 1 defined by the line 8-8.

FIG. 9 is an enlarged view showing a portion of FIG. 5 defined by the line 9-9.

FIG. 10 is an enlarged view showing a portion of FIG. 6 defined by the line 10-10.

FIG. 11 is an enlarged view showing a portion of FIG. 7 defined by the line 11-11.

FIG. 12 is an enlarged cross-sectional view taken along the line 12-12 in FIG. 8.

FIG. 13 is an enlarged cross-sectional view taken along the line 13-13 in FIG. 9.

FIG. 14 is an enlarged cross-sectional view taken along the line 14-14 in FIG. 9; and,

FIG. 15 is an enlarged cross-sectional view taken along the line 15-15 in FIG. 9.

The features shown in broken lines depict environmental subject matter only and form no part of the claimed design. The alternating long and short dashed lines indicate bounds of the claimed design and form no part thereof.

1 Claim, 15 Drawing Sheets

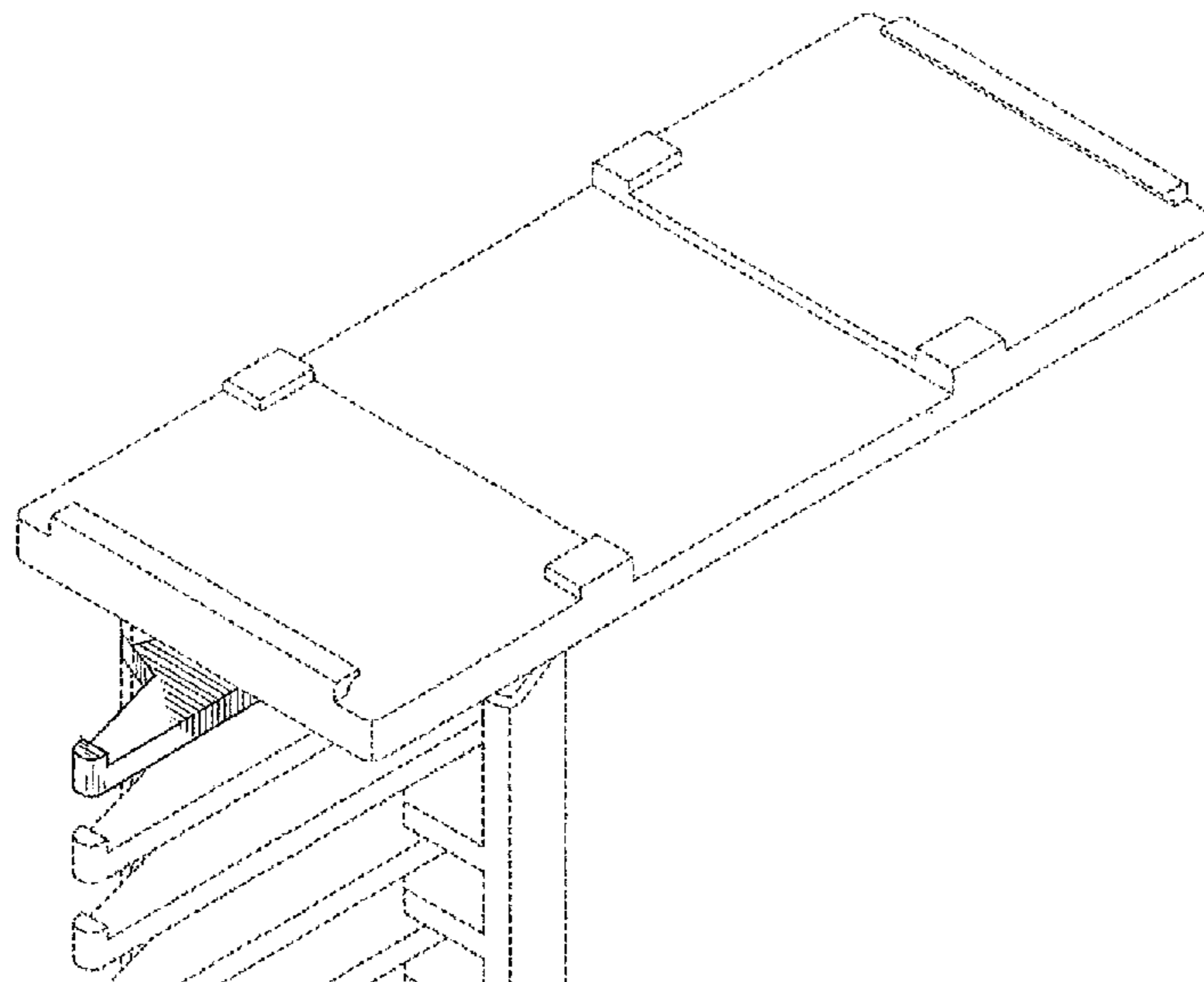

(58) **Field of Classification Search**

USPC 361/752, 736, 728, 796, 797, 729, 730,
 361/725-727, 801, 798; 400/412,
 400/713-715; 428/137-138, 140, 304.4,
 428/457; 442/9; D3/273; D6/201, 204,
 D6/429-431, 449, 474, 509-510;
 D9/432; D10/65, 75, 78; D13/103, 119,
 D13/162, 184, 199; D14/110, 114, 125,
 D14/240, 242, 299-302, 314, 348-370,
 D14/435-438, 496, 478-480, 432, 453;
 D18/1, 7, 9, 11; 235/441, 443, 487, 492,
 235/493, 495, 380, 382, 382.5, 375, 494;
 257/678, 679, 693, E23.064; 439/946,
 439/948, 159, 352, 157, 298, 328, 377,
 439/64; 174/250, 260, 52.1, 52.2;
 710/300-303; 438/121; 348/79, 80;
 D8/354; 403/322.1, 322.4; 353/103,
 353/104, 108-118
 CPC G06K 19/06196; G06K 19/072; G06K
 19/0721; G06K 19/0722; G06K 19/0723;
 G06K 19/0724; G06K 19/0725; G06K
 19/0726; G06K 19/0727; G06K 19/0728;
 G06K 19/073; G06K 19/07309; G06K
 19/077; G06K 19/07701; G06K
 19/07715; G06K 19/0772; G06K
 19/07724; G06K 19/07726; G06K
 19/07728; G06K 19/06037-06206; G06K
 19/067; G06K 2019/06262; G06K
 7/1417-1495; G06F 21/86; G06F 21/87;
 G06F 21/88; G06F 21/77-80; G06F
 21/85-88; G06F 21/00; G06F 1/186-188;
 G06Q 20/3229; G06Q 20/34; G06Q
 20/341; G06Q 20/346; G06Q 20/349;
 G06Q 20/3563; G06Q 20/3567; G06Q
 20/357; G06Q 20/3576; G06Q 20/3276;
 H05K 5/026; H05K 5/0256; H05K
 5/0265; H05K 5/0269; H05K 5/0273;
 H05K 5/078; H05K 5/0282; H05K
 5/0286; H05K 5/0291; H05K 5/0295;
 H05K 5/03; H05K 5/04; H05K 5/06;
 H05K 5/061; H05K 5/062; H05K 5/063;
 H05K 5/064; H05K 5/065; H05K 5/066;
 H05K 5/067; H05K 5/068; H05K 5/069;
 H05K 7/00; H05K 7/005; H05K 7/02;
 H05K 7/023; H05K 7/026; H05K 7/04;
 H05K 7/10; H05K 7/1418; H05K 7/142;
 H05K 7/1424; H05K 7/1427-1439; H05K
 7/1461; H05K 7/1464-1474; H05K
 7/1479; H05K 7/1481; H05K
 7/1485-1488; H05K 2201/09745; H05K
 2201/09754; H05K 2201/09763; H05K
 2201/09772; H05K 2201/098; H05K
 2201/09818; H05K 2201/10; H05K
 2201/10007; H05K 7/1411; H05K
 7/1409; H05K 7/1417; H05K
 7/1421-1454; H04N 2201/216; G07C
 9/00722; G07C 9/00571; G07C 9/00904;
 G07C 9/00103; G03B 23/00; G03B
 23/048; G02B 21/365; G02B 21/367;
 G02B 21/002; Y10T 403/591; Y10T
 403/595; Y10T 74/18944; Y10T 74/1896;
 H01R 13/62933; H01R 13/62944; H01R
 13/6295; H01R 13/62955; H01R
 13/62961; H01R 13/62983; H01R 12/70;

H01R 12/7005; H01R 12/7011

See application file for complete search history.

(56)

References Cited

U.S. PATENT DOCUMENTS

D303,988 S * 10/1989 Buchweitz, Jr. D18/59
 D310,520 S * 9/1990 Bedard D14/432
 D310,823 S * 9/1990 Chabala D13/175
 D312,205 S * 11/1990 de Rooij 40/759
 D315,720 S * 3/1991 Freehauf D13/154
 5,136,864 A * 8/1992 Spiekermann A44B 19/301
 70/312
 5,726,435 A 3/1998 Hara et al.
 D414,165 S 9/1999 Klein
 6,878,006 B1 * 4/2005 Heidenreich H01R 13/62933
 361/798
 6,912,124 B2 * 6/2005 Megason F16H 51/00
 165/104.33
 6,948,961 B2 * 9/2005 Oguchi H01R 13/6335
 439/160
 6,992,900 B1 * 1/2006 Suzue H05K 7/1409
 361/726
 7,140,738 B2 * 11/2006 Guiney G03B 23/00
 353/103
 7,295,447 B2 * 11/2007 Strmiska H05K 7/1409
 312/223.2
 7,300,163 B2 * 11/2007 Scampini G01N 35/00029
 353/103
 7,301,778 B1 * 11/2007 Fang H05K 7/1409
 312/223.2
 D578,127 S 10/2008 Crisp et al.
 7,571,864 B2 8/2009 Kiliccote
 7,753,457 B2 * 7/2010 Wood B01L 9/52
 312/319.1
 7,859,667 B2 * 12/2010 Scampini G01N 35/00029
 353/103
 8,098,956 B2 * 1/2012 Tatke G02B 21/365
 348/144
 D656,391 S * 3/2012 McClain D8/354
 D673,956 S * 1/2013 Yokoyama D14/432
 D686,623 S 7/2013 Bennett, Jr. et al.
 8,573,499 B1 11/2013 Boyle
 8,593,827 B1 * 11/2013 Lewis H05K 7/1411
 361/801
 8,625,930 B2 * 1/2014 Tatke G02B 21/365
 382/128
 8,675,992 B2 * 3/2014 Dietz G02B 21/365
 348/144
 D702,646 S * 4/2014 Uebayashi D13/154
 8,744,213 B2 * 6/2014 Tatke G02B 21/365
 342/176
 8,797,396 B2 * 8/2014 Dietz G02B 21/365
 348/79
 8,985,443 B1 3/2015 Boyle
 D740,817 S 10/2015 Ignomirello
 9,300,658 B1 3/2016 Sadacharam et al.
 D755,182 S 5/2016 Bassett et al.
 9,576,172 B2 2/2017 Huang et al.
 9,776,322 B2 * 10/2017 Nilsson G01N 35/00029
 D808,970 S 1/2018 Gessford et al.
 D830,363 S 10/2018 Helms et al.
 D830,974 S * 10/2018 Kufner D13/154
 D839,271 S 1/2019 King-Murrey et al.
 D860,140 S * 9/2019 Wu D13/154
 D866,555 S * 11/2019 Suzuki D14/432
 D872,699 S * 1/2020 Chen D13/154
 2005/0142940 A1 6/2005 Manine
 2006/0109432 A1 * 5/2006 Guiney G03B 23/00
 353/103
 2008/0002853 A1 1/2008 Kawabe et al.
 2008/0013272 A1 1/2008 Bailey et al.
 2008/0121688 A1 5/2008 Harrop
 2008/0240613 A1 * 10/2008 Dietz G02B 21/367
 382/284
 2008/0301464 A1 12/2008 Parkinson

(56)

References Cited

U.S. PATENT DOCUMENTS

2009/0043783	A1	2/2009	Wakasa et al.	2014/0110486	A1	4/2014	Nemet
2009/0057420	A1	3/2009	Onoda et al.	2014/0117100	A1	5/2014	Black et al.
2009/0108057	A1	4/2009	Mu et al.	2014/0117101	A1	5/2014	Cok
2009/0255992	A1	10/2009	Shen	2014/0144996	A1	5/2014	Friedman et al.
2011/0043858	A1	2/2011	Jetter	2014/0149285	A1	5/2014	De et al.
2012/0027325	A1*	2/2012	Lacarra A47B 88/57 384/18	2014/0224888	A1	8/2014	Bomer et al.
2012/0104105	A1	5/2012	Nemet et al.	2014/0224889	A1	8/2014	Key
2012/0197660	A1	8/2012	Prodanovich	2014/0263667	A1	9/2014	Mege
2012/0209688	A1	8/2012	Lamothe et al.	2014/0263674	A1	9/2014	Cervený
2012/0267440	A1	10/2012	Nakaya et al.	2014/0263675	A1	9/2014	Beadles
2012/0323699	A1	12/2012	Phillips	2014/0281855	A1	9/2014	Bhatnagar
2013/0026241	A1	1/2013	Sakahashi et al.	2015/0008257	A1	1/2015	Beadles
2013/0043302	A1	2/2013	Powlen et al.	2015/0161496	A1	6/2015	Rodriguez et al.
2013/0087609	A1	4/2013	Nichol et al.	2015/0199601	A1	7/2015	Bienek
2013/0126598	A1	5/2013	Beadles et al.	2015/0213734	A1	7/2015	Glickman
2013/0146658	A1	6/2013	Guerra	2015/0229603	A1	8/2015	Chor
2013/0166441	A1	6/2013	Kobylkin et al.	2015/0269466	A1	9/2015	Inotay et al.
2013/0221114	A1	8/2013	Myers et al.	2015/0269469	A1	9/2015	Sharma et al.
2013/0320099	A1	12/2013	Acton et al.	2015/0363683	A1	12/2015	Polzoni
2013/0341417	A1	12/2013	Argue et al.	2016/0086072	A1	3/2016	Castillo
2014/0070012	A1	3/2014	Hunt et al.	2016/0140428	A1	5/2016	Kamitani et al.
2014/0100973	A1	4/2014	Brown et al.	2016/0155033	A1	6/2016	Nakano et al.
2014/0108606	A1	4/2014	Beadles	2016/0180131	A1	6/2016	Seo et al.
2014/0110468	A1	4/2014	Kandregula	2017/0235977	A1	8/2017	Nadabar et al.
				2018/0025263	A1	1/2018	Toyozumi et al.
				2018/0137323	A1	5/2018	Jiang et al.
				2018/0157813	A1	6/2018	Rodrigs et al.

* cited by examiner

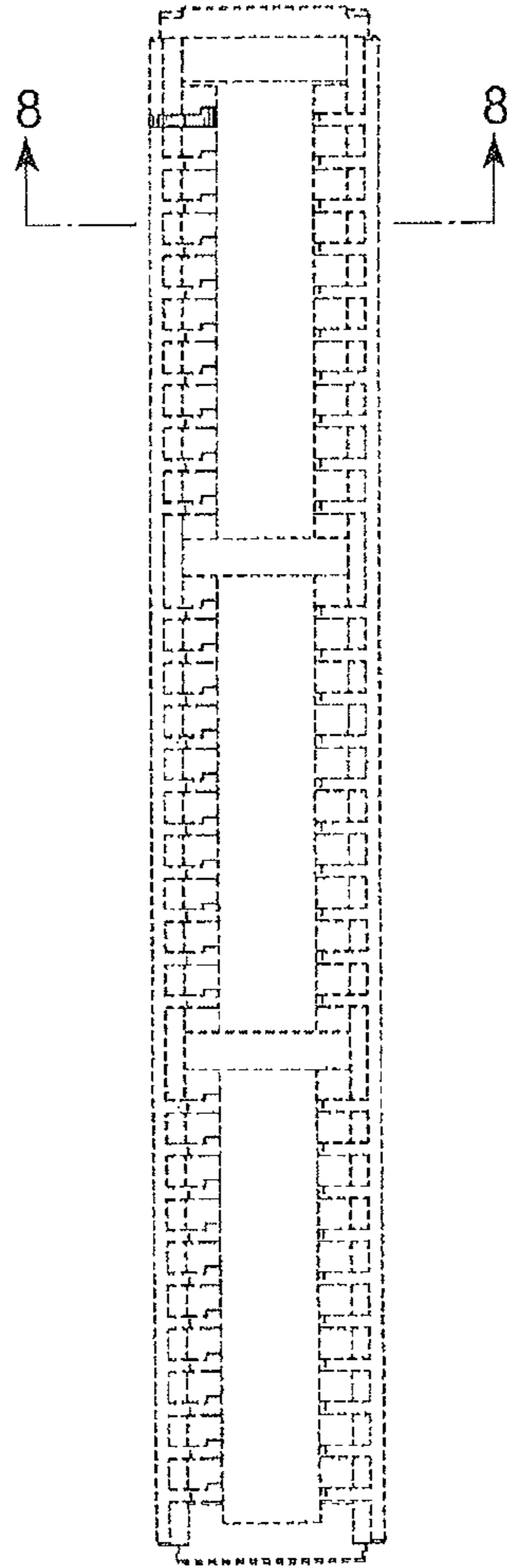

FIG. 1

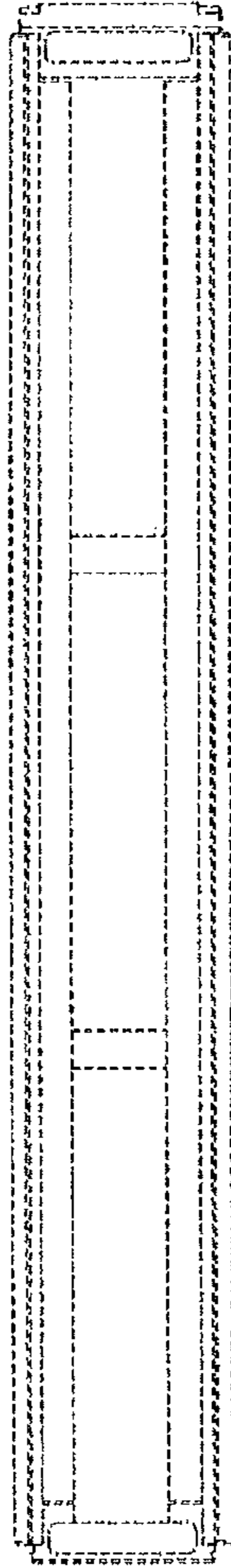

FIG. 2

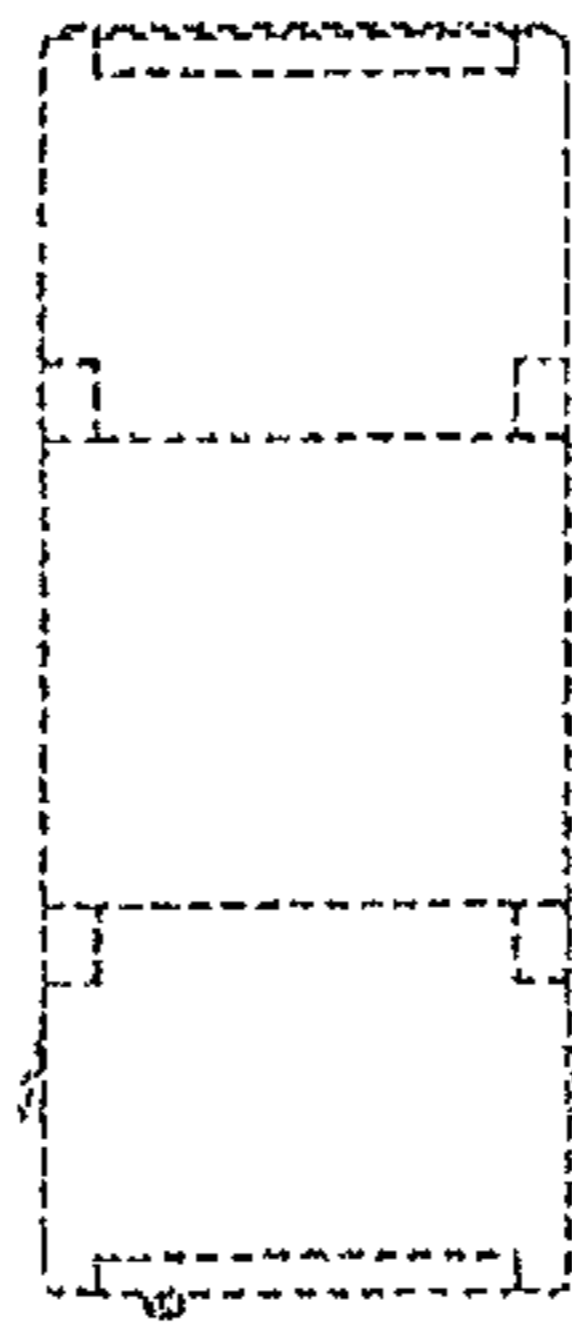

FIG. 3

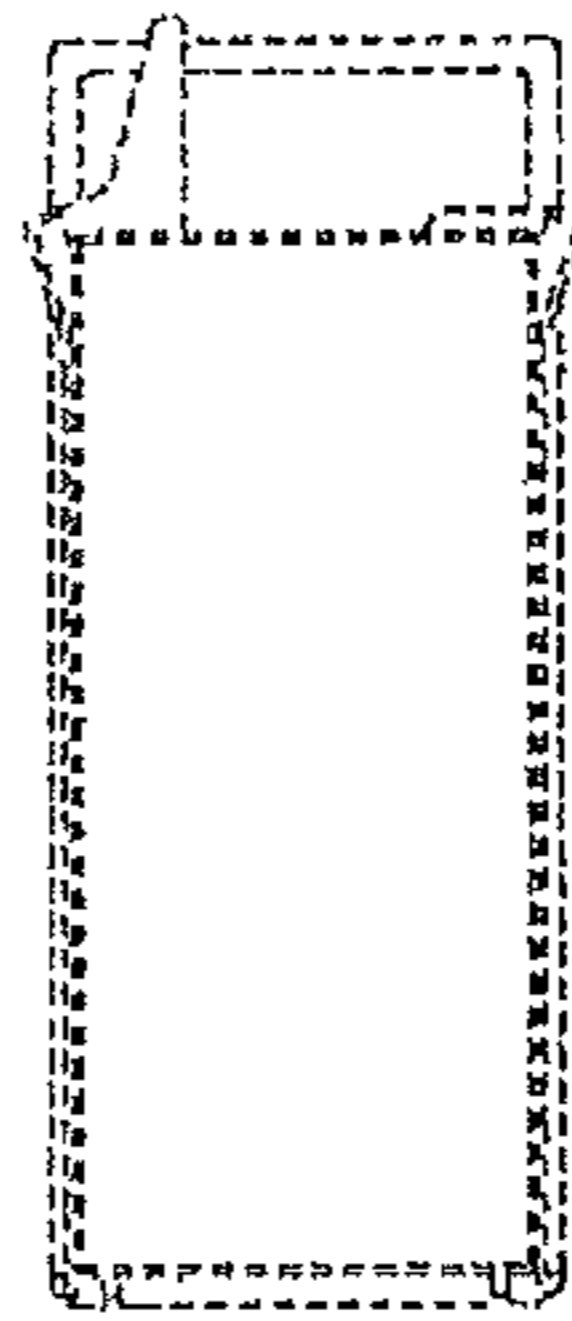

FIG. 4

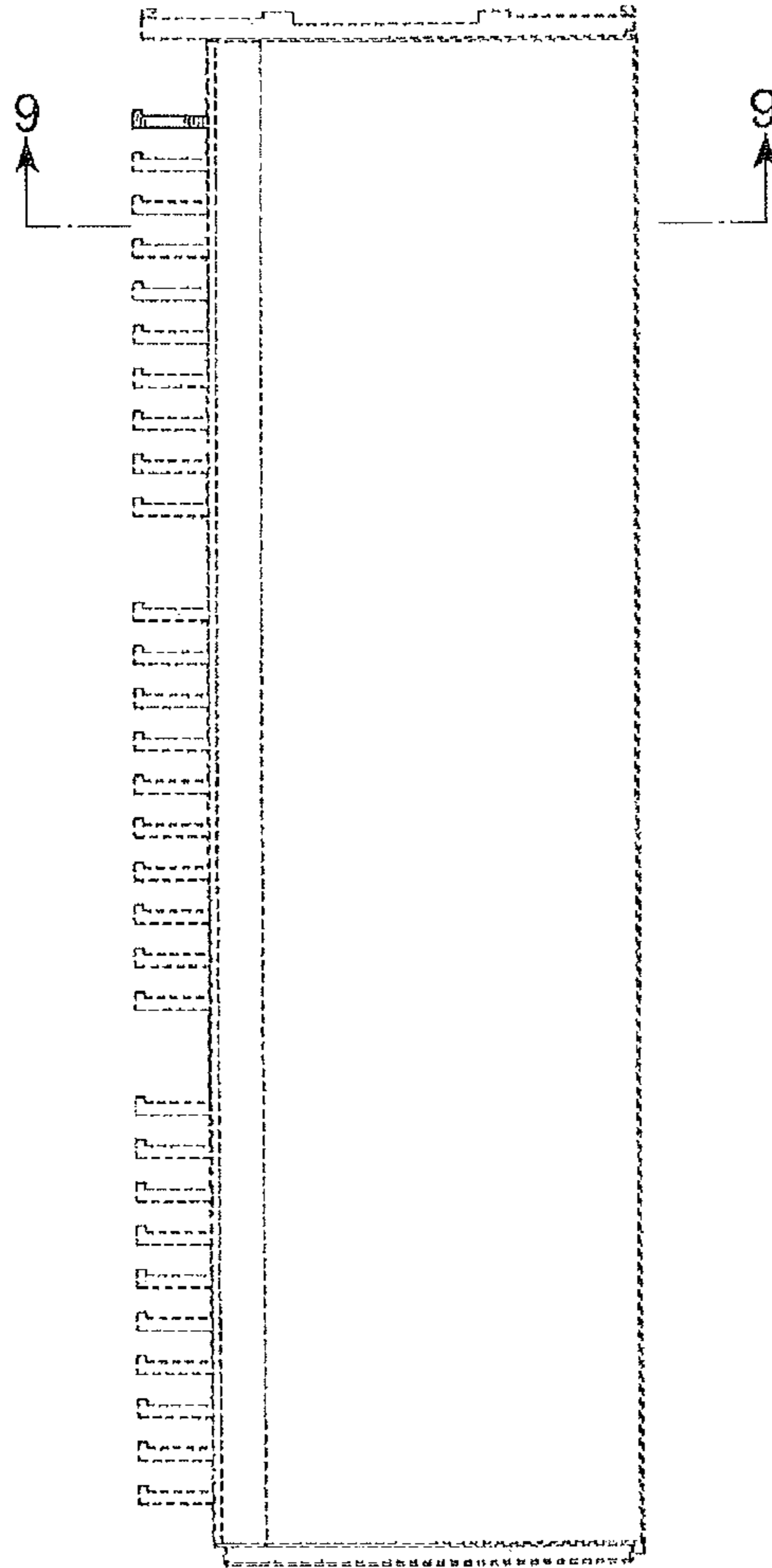

FIG. 5

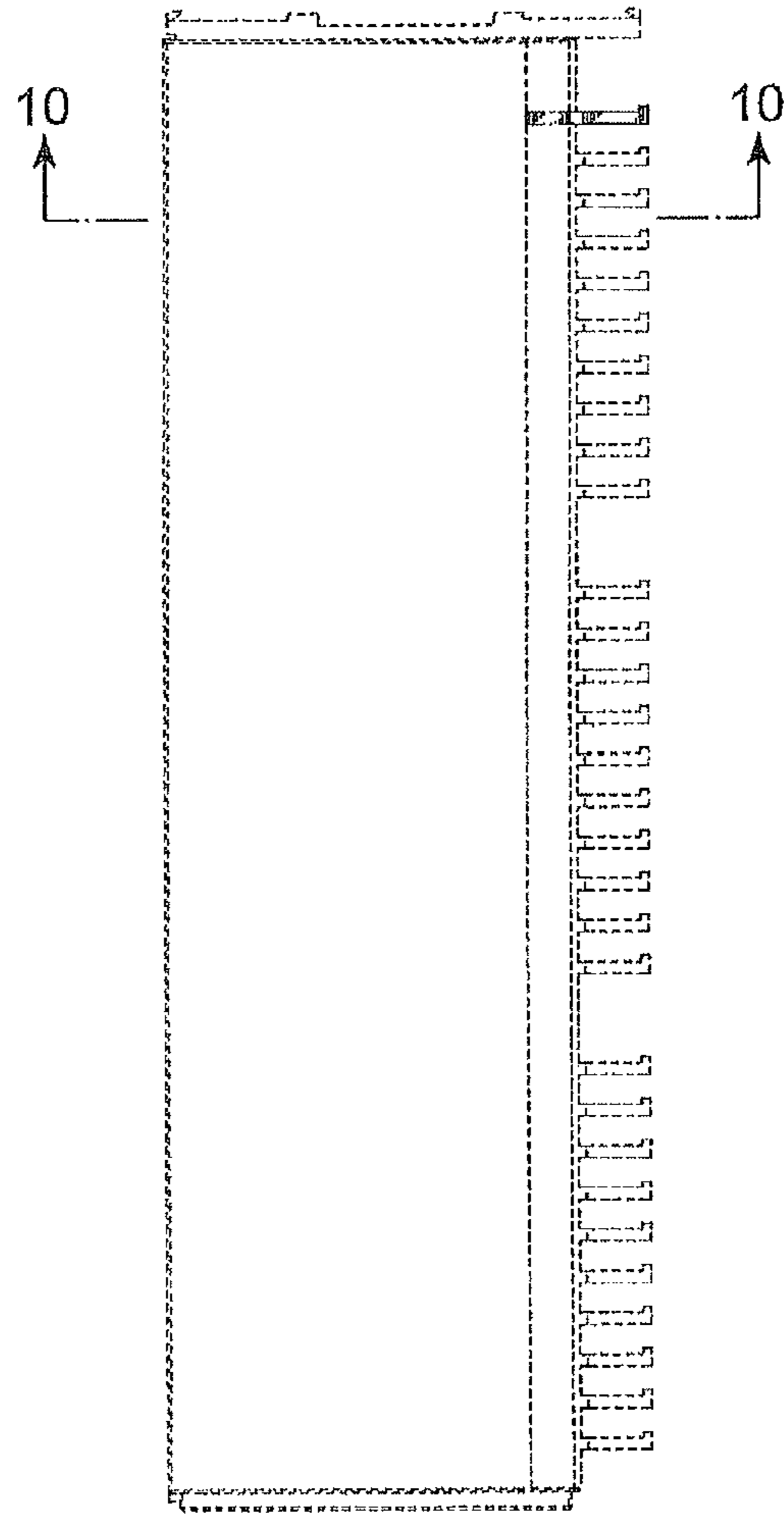

FIG. 6

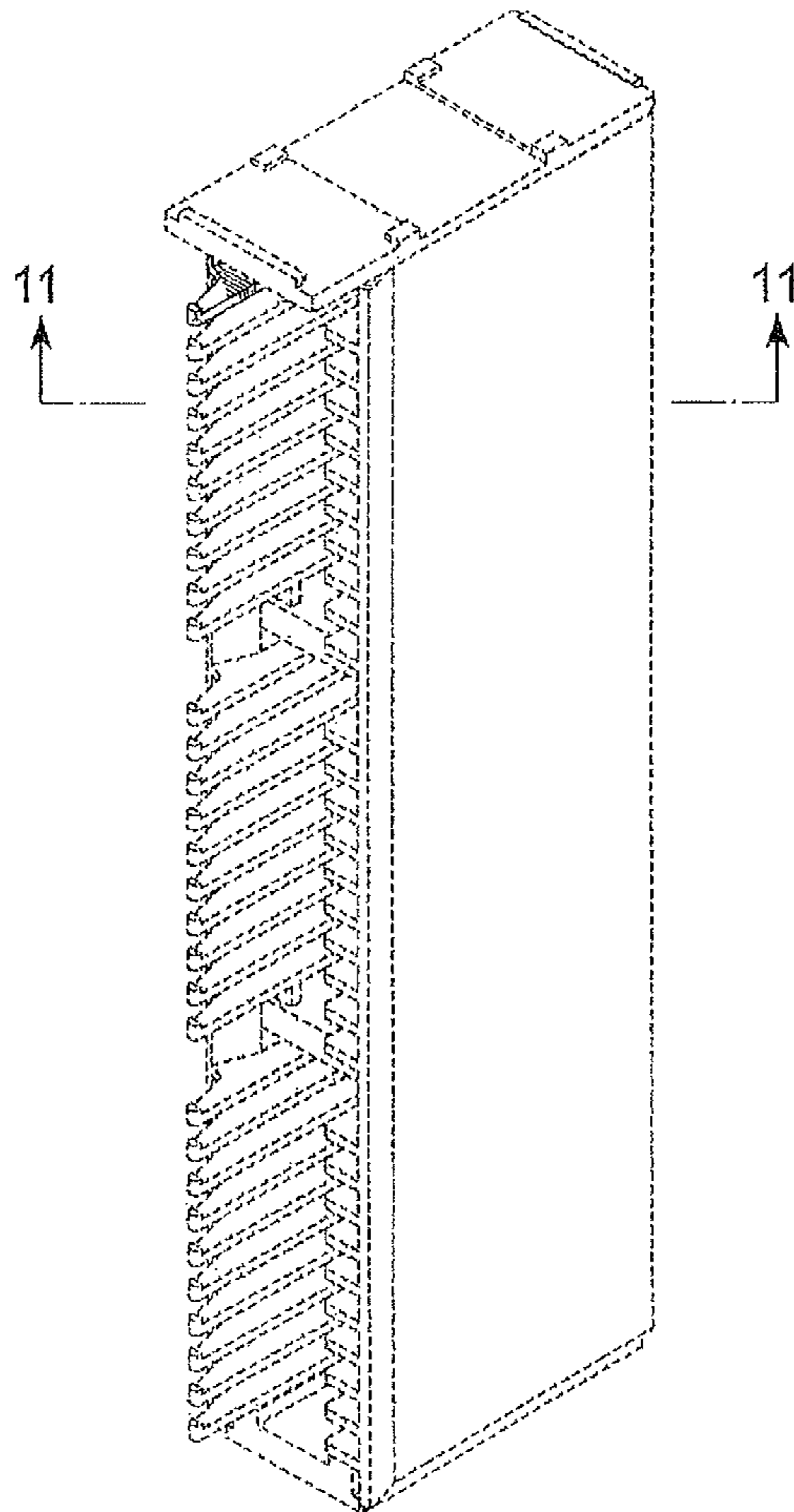

FIG. 7

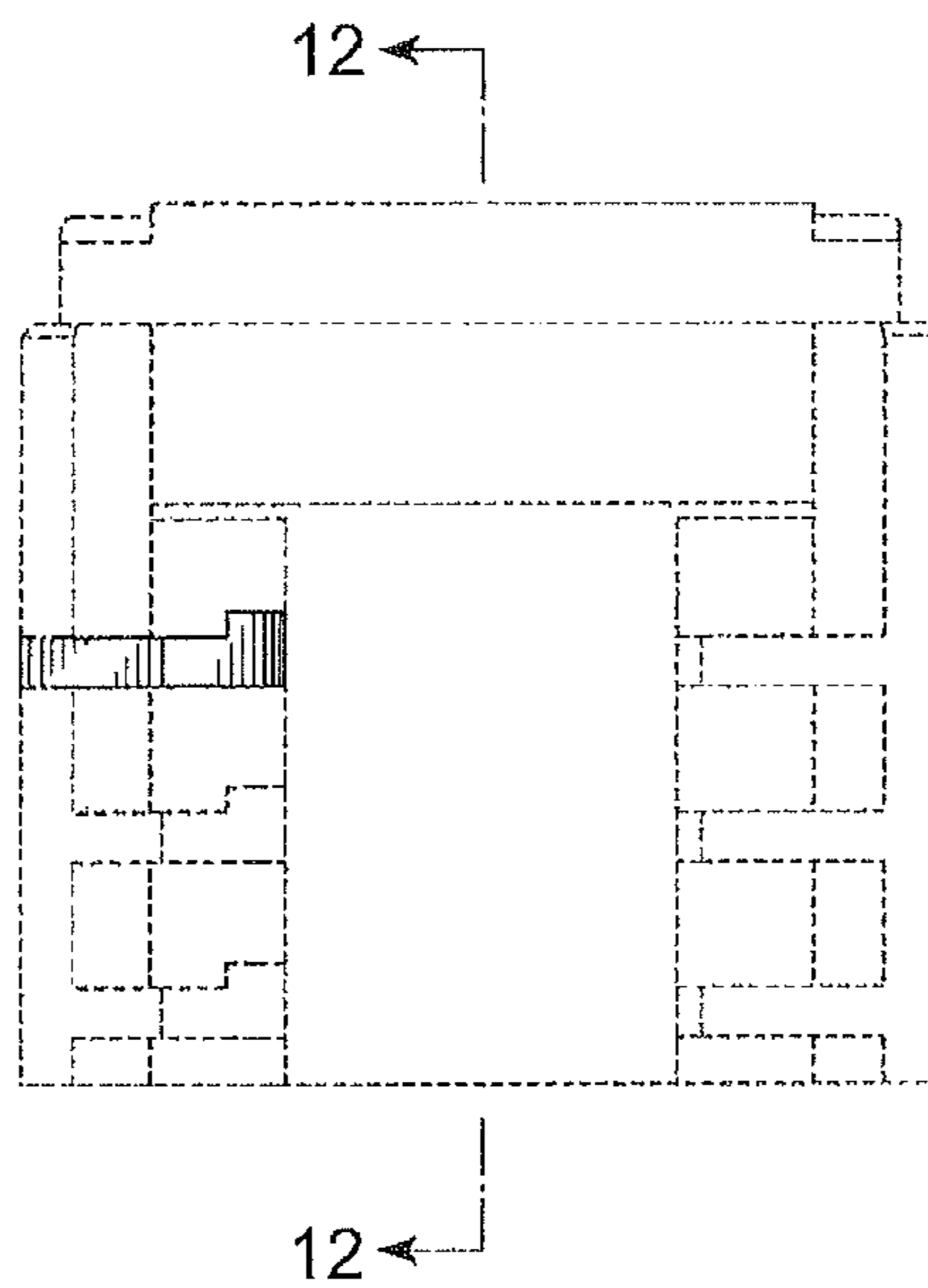

FIG. 8

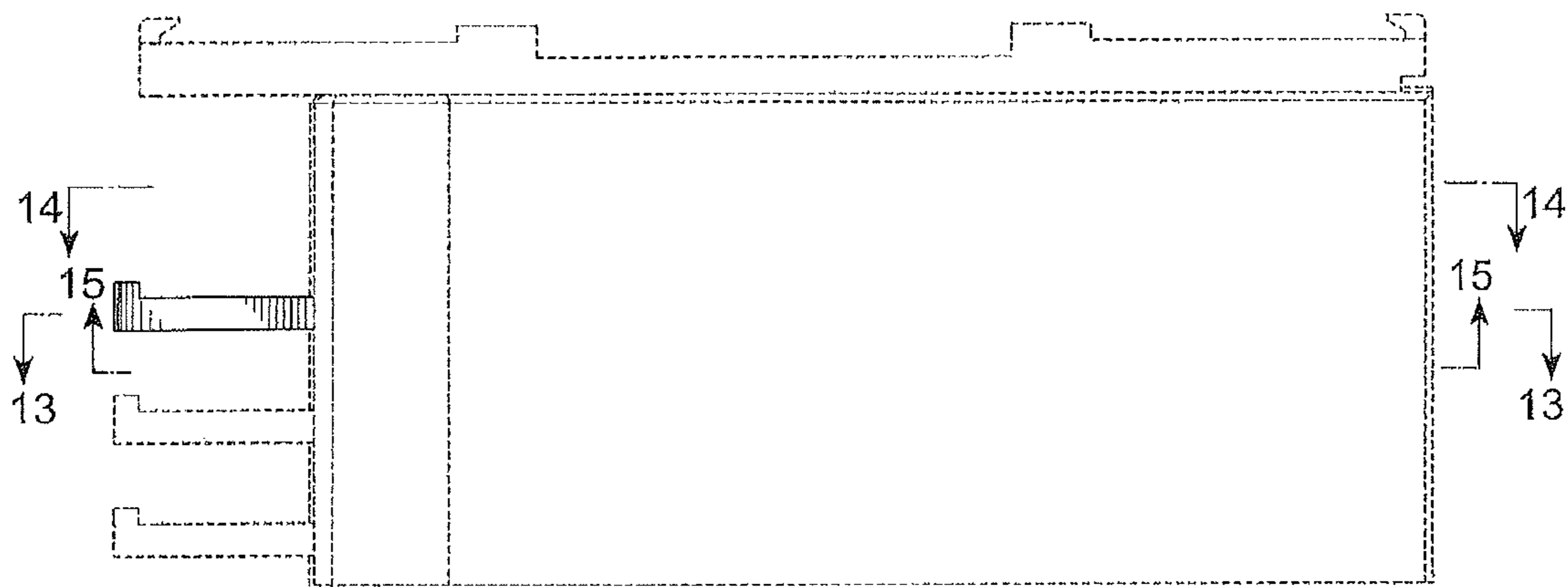

FIG. 9

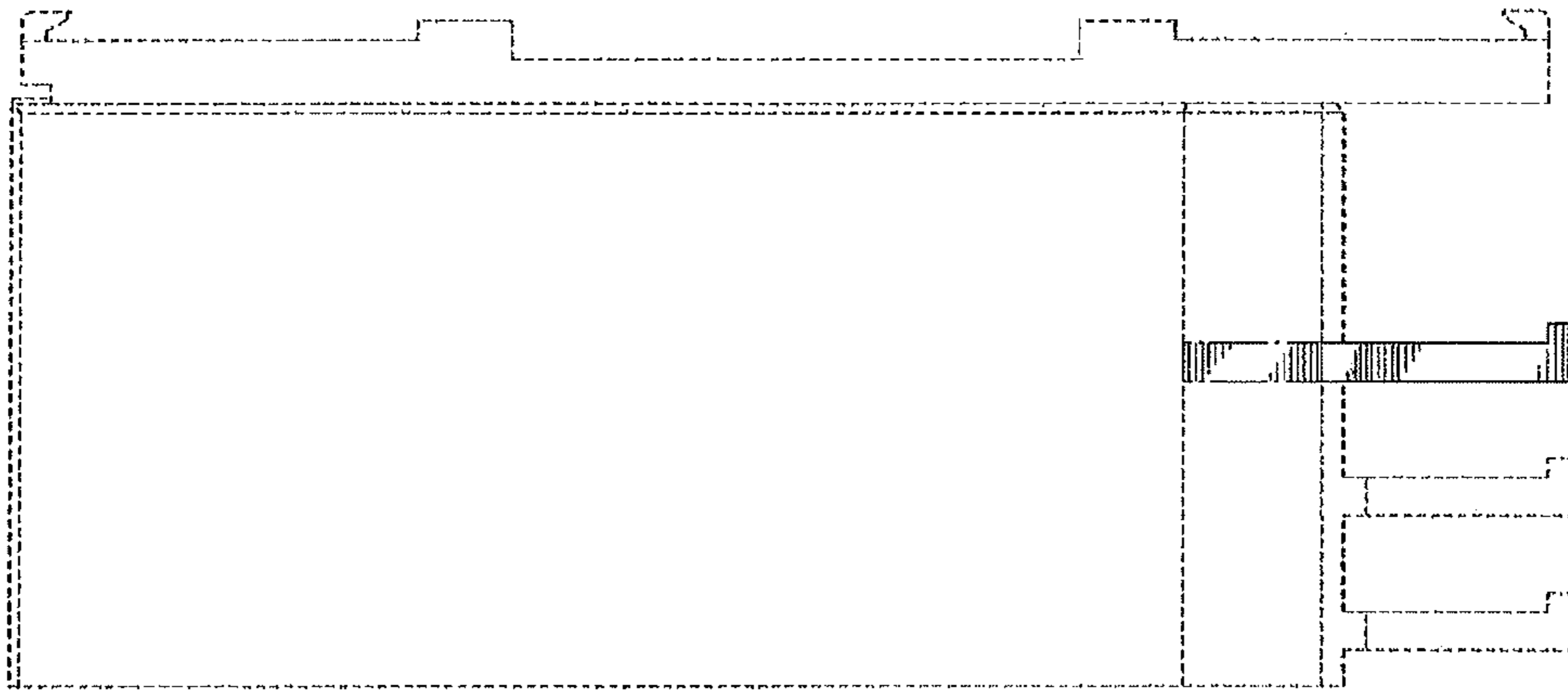

FIG. 10

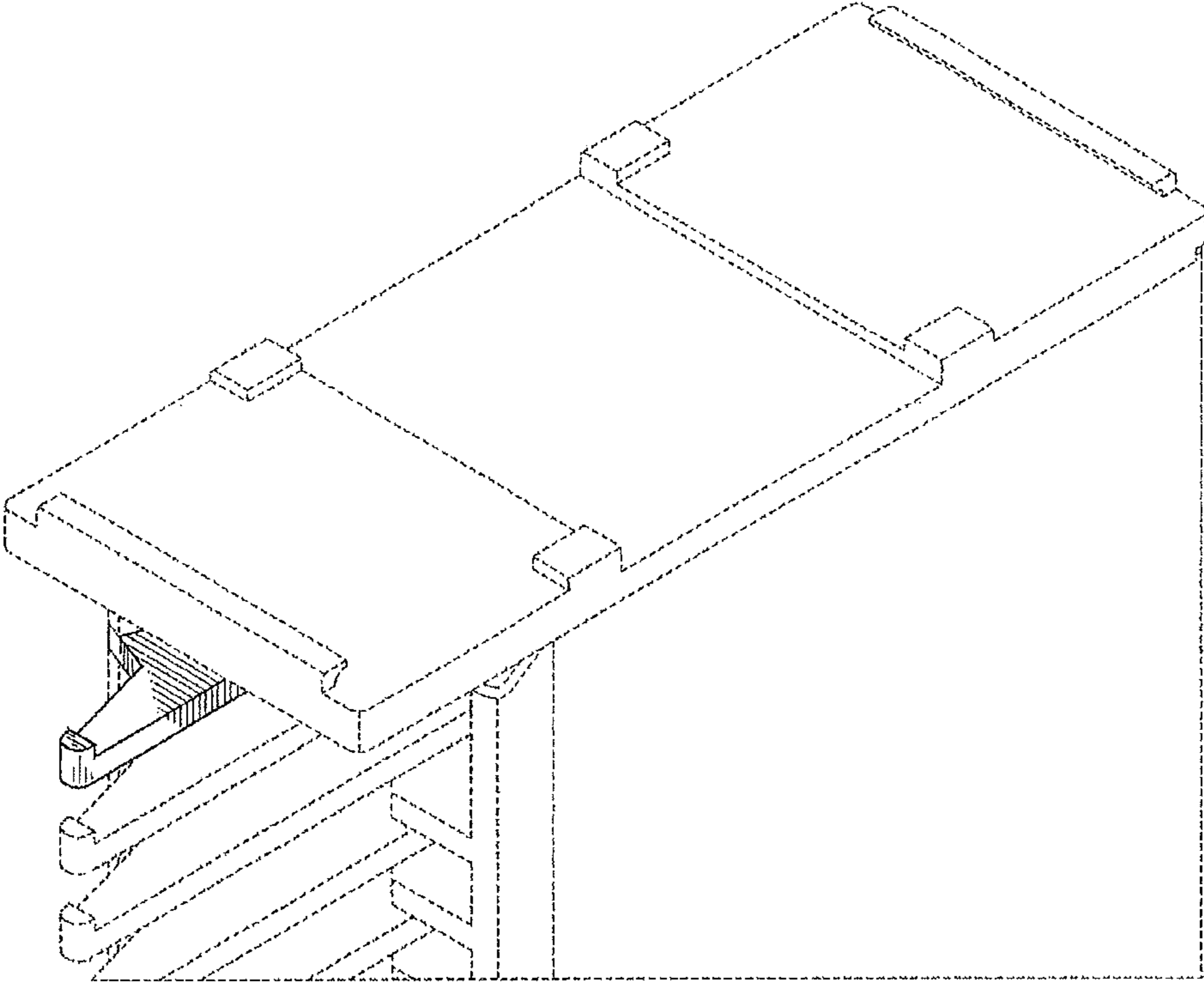

FIG. 11

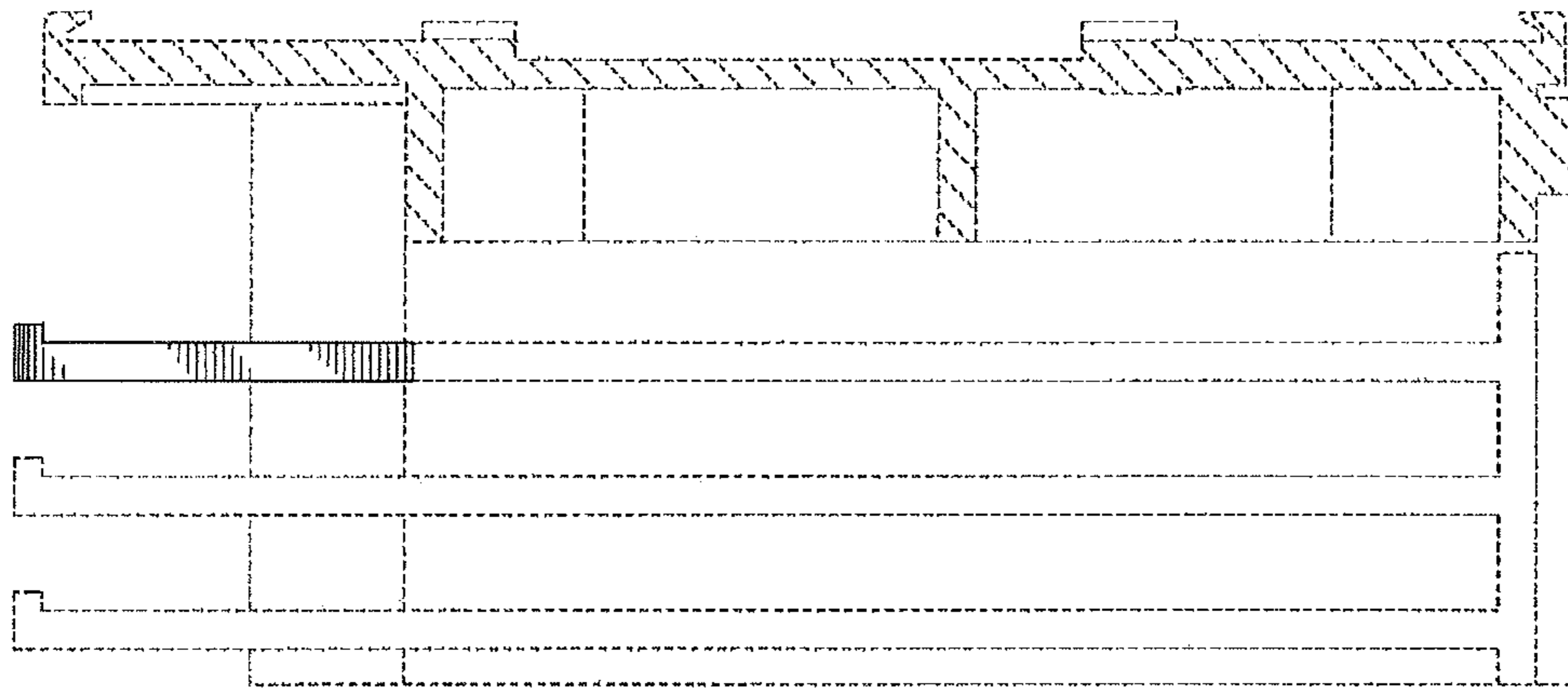

FIG. 12

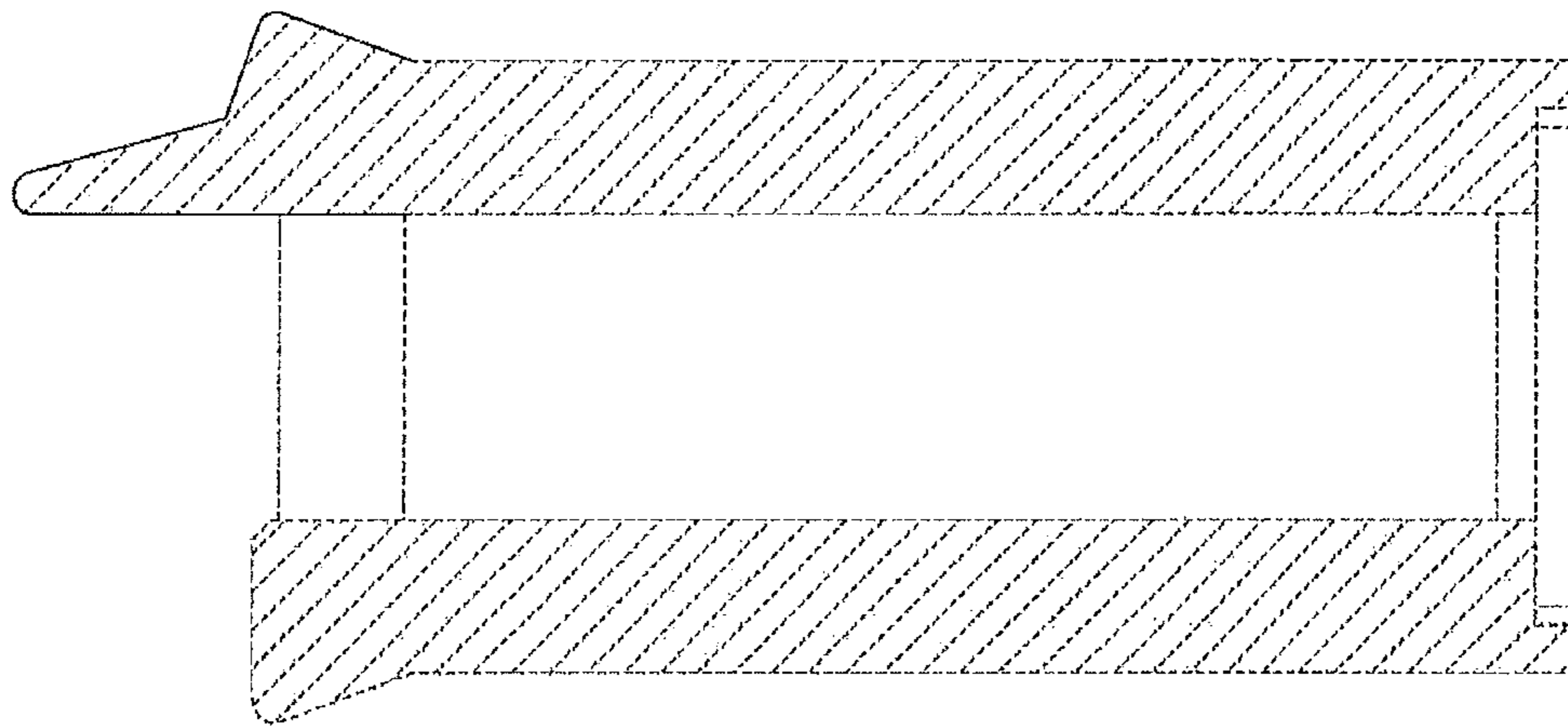

FIG. 13

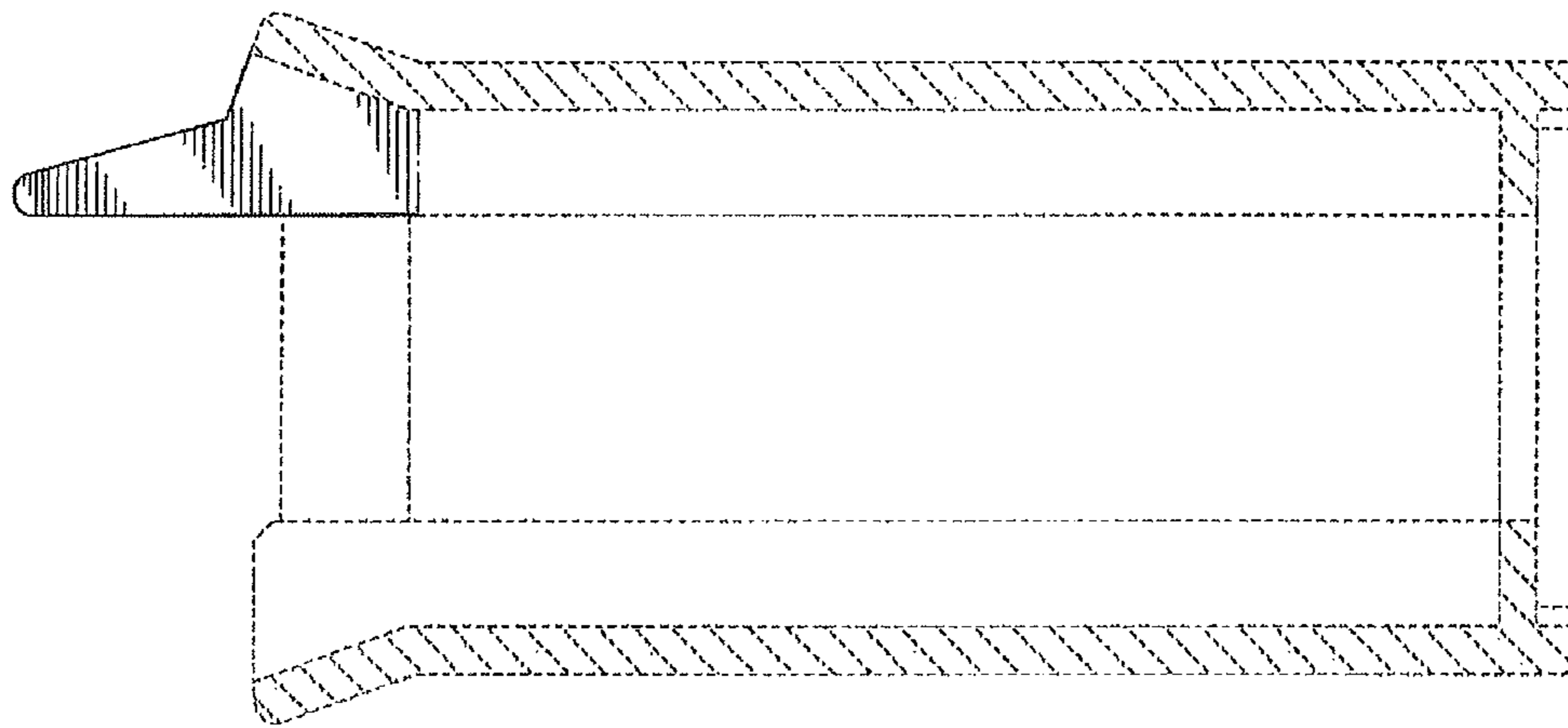

FIG. 14

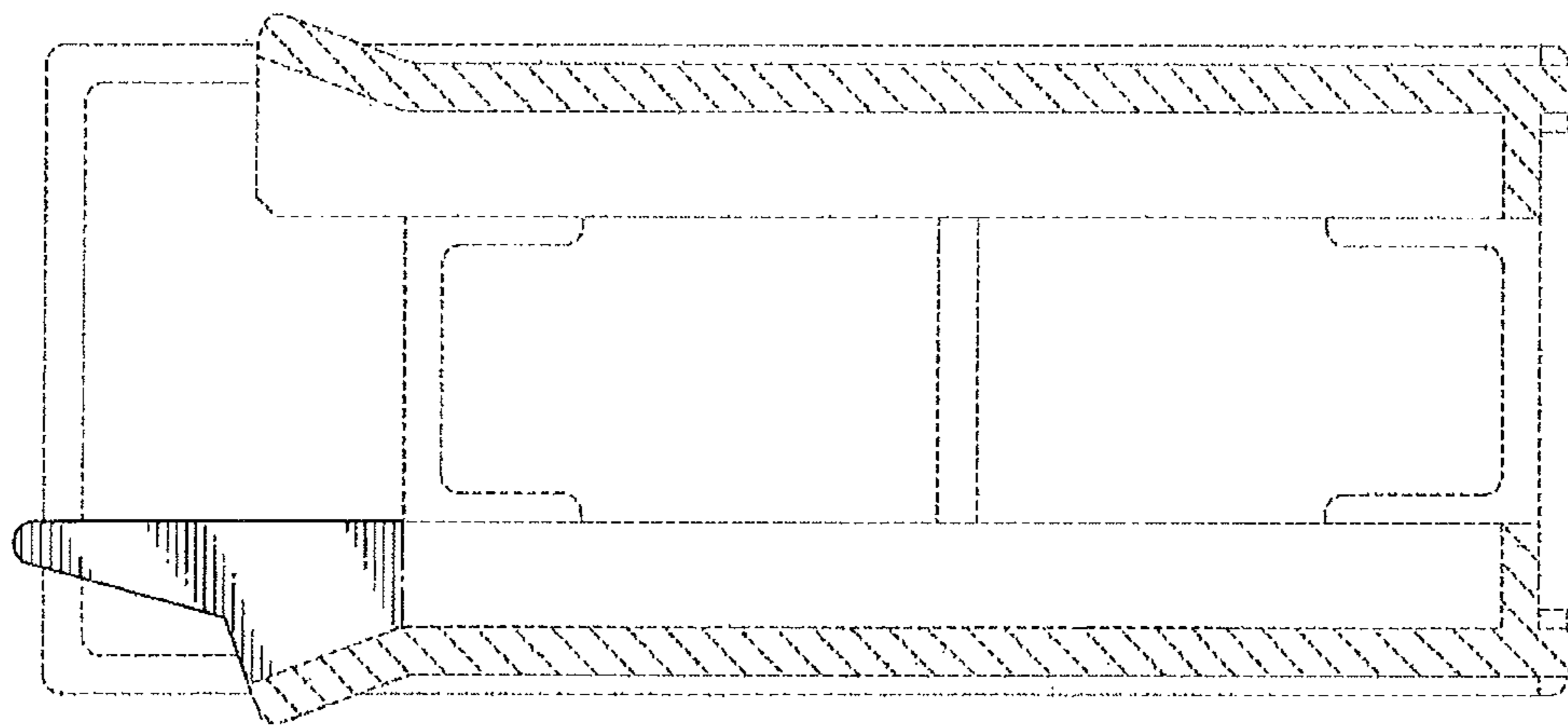

FIG. 15