



US00D886820S

(12) **United States Design Patent** (10) **Patent No.:** **US D886,820 S**  
**Nishizawa** (45) **Date of Patent:** **\*\* \*Jun. 9, 2020**

(54) **DIGITAL NOTEBOOK**

- (71) Applicant: **Wacom Co., Ltd.**, Kazo-shi, Saitama (JP)
- (72) Inventor: **Naoya Nishizawa**, Tokyo (JP)
- (73) Assignee: **Wacom Co., Ltd.**, Kazo-shi (JP)
- (\* ) Notice: This patent is subject to a terminal disclaimer.
- (\*\* ) Term: **15 Years**
- (21) Appl. No.: **29/703,989**
- (22) Filed: **Aug. 30, 2019**

**Related U.S. Application Data**

- (63) Continuation of application No. 29/594,646, filed on Feb. 21, 2017, now Pat. No. Des. 862,456.

(30) **Foreign Application Priority Data**

- Aug. 26, 2016 (JP) ..... 2016-018159
- (51) **LOC (12) Cl.** ..... **14-02**
- (52) **U.S. Cl.**  
USPC ..... **D14/345**
- (58) **Field of Classification Search**  
USPC ..... D14/341-347, 125-134, 137, 138 R,  
D14/138 AA, 138 AB, 138 C, 138 G, 147,  
(Continued)

(56) **References Cited**

**U.S. PATENT DOCUMENTS**

- D523,853 S 6/2006 Ishikawa et al.
  - D617,299 S 6/2010 Tzeng et al.
- (Continued)

**FOREIGN PATENT DOCUMENTS**

- JP D1547680 S 4/2016
- JP D1554118 S 7/2016

**OTHER PUBLICATIONS**

Collins Debden Ltd Ringbinder Folio with Zipper—Black, posted Dec. 30, 2007, [retrieved Nov. 1, 2019]. Retrieved from Internet, <URL: [https://www.amazon.co.uk/dp/B00123147M/ref=psdc\\_200831031\\_t3\\_B01MCT751U](https://www.amazon.co.uk/dp/B00123147M/ref=psdc_200831031_t3_B01MCT751U) >.\*

(Continued)

*Primary Examiner* — Shannon W Morgan  
*Assistant Examiner* — Kristin E Reed  
 (74) *Attorney, Agent, or Firm* — Christensen O'Connor Johnson Kindness PLLC

(57) **CLAIM**

The ornamental design for a digital notebook, as shown and described.

**DESCRIPTION**

FIG. 1 is a front perspective view of a digital notebook with a cover open according to a first embodiment of my new design;  
 FIG. 2 is a rear perspective view thereof;  
 FIG. 3 is a front perspective view of the digital notebook of FIG. 1 with the cover closed;  
 FIG. 4 is a front elevational view of the digital notebook of FIG. 1;  
 FIG. 5 is a rear elevational view thereof;  
 FIG. 6 is a top plan view thereof;  
 FIG. 7 is a bottom plan view thereof;  
 FIG. 8 is a right side elevational view thereof;  
 FIG. 9 is a left side elevational view thereof;  
 FIG. 10 is a partial front perspective view of a portion of the digital notebook indicated in FIG. 1;  
 FIG. 11 is a partial front elevational view of a portion of the digital notebook indicated in FIG. 4;  
 FIG. 12 is a front perspective view of a digital notebook with a cover open according to a second embodiment of my new design;  
 FIG. 13 is a rear perspective view thereof;  
 FIG. 14 is a front perspective view of the digital notebook of FIG. 12 with the cover closed;  
 FIG. 15 is a front elevational view of the digital notebook of FIG. 12;

(Continued)

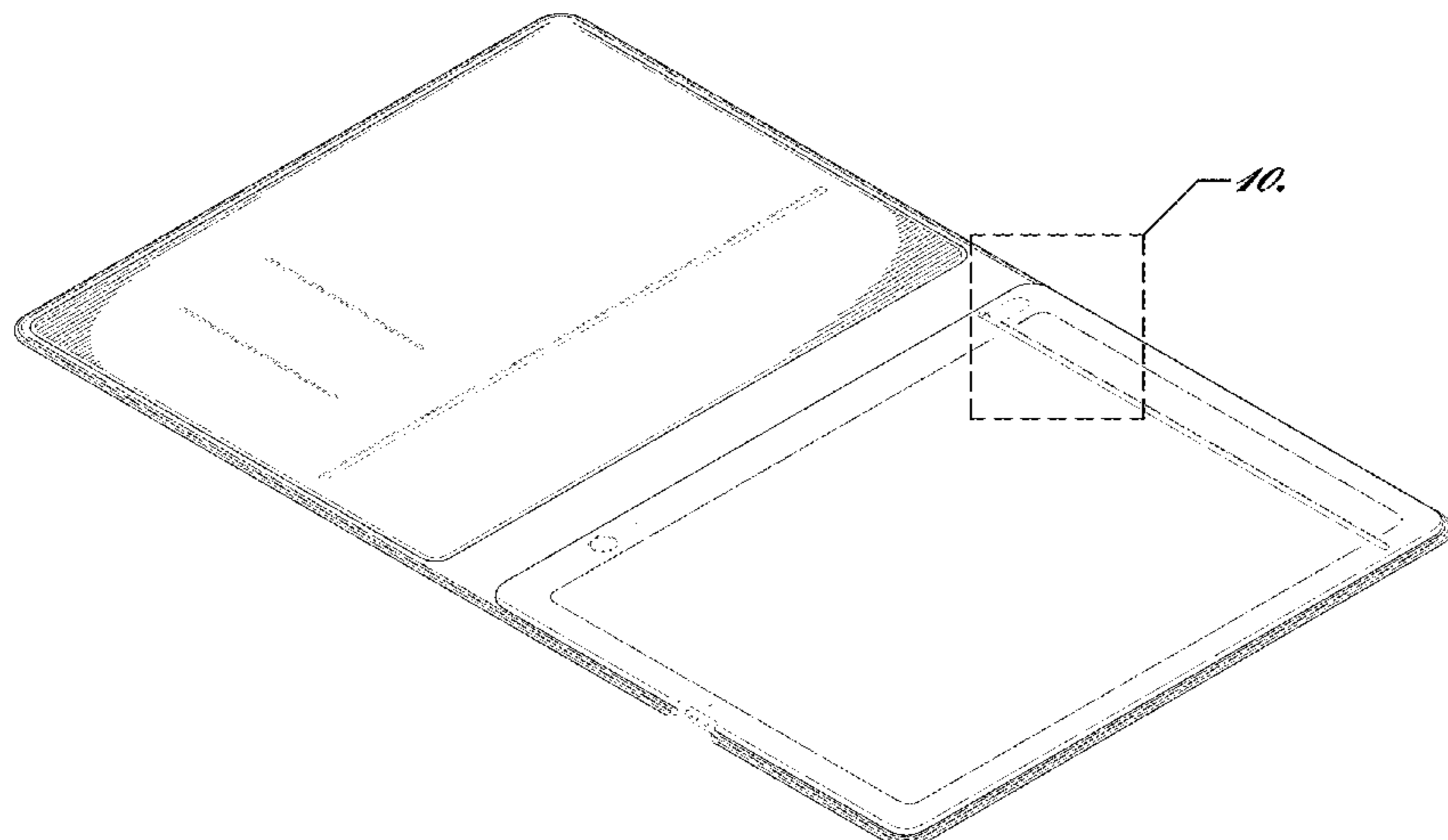


FIG. 16 is a rear elevational view thereof;  
 FIG. 17 is a top plan view thereof;  
 FIG. 18 is a bottom plan view thereof;  
 FIG. 19 is a right side elevational view thereof;  
 FIG. 20 is a left side elevational view thereof;  
 FIG. 21 is a partial front perspective view of a portion of the digital notebook indicated in FIG. 12; and,  
 FIG. 22 is a partial front elevational view of a portion of the digital notebook indicated in FIG. 15.  
 The dot-dot-dash broken lines indicate the boundary of the enlarged portions of the drawings. The remaining broken lines in the figures depict portions of the digital notebook. The broken lines form no part of the claimed design.

**1 Claim, 18 Drawing Sheets**

(58) **Field of Classification Search**

USPC ... D14/203.1, 203.3, 203.4, 203.7, 218, 247,  
 D14/248, 332, 336, 371, 374-377, 388,  
 D14/389, 315-318, 420, 426, 429, 440,  
 D14/448, 450, 489, 492, 496;  
 D6/300-310; D10/50, 65, 98, 104.1;  
 D16/241; D18/6; D20/10, 19, 39;  
 D21/329, 330  
 CPC . A63H 33/3016; G06F 1/1613; G06F 1/1641;  
 G06F 1/1643; G06F 1/1647; G06F  
 3/04883; G06F 3/0486; G06F 3/04847;  
 G06F 3/04845; G06F 3/0484; G06F  
 3/04817; H05K 5/0004; H05K 5/0017;  
 H05K 5/02; H05K 5/0217; H04M 1/0279;  
 H04M 1/0281; H04M 1/0283; H04N  
 13/0459

See application file for complete search history.

(56)

**References Cited**

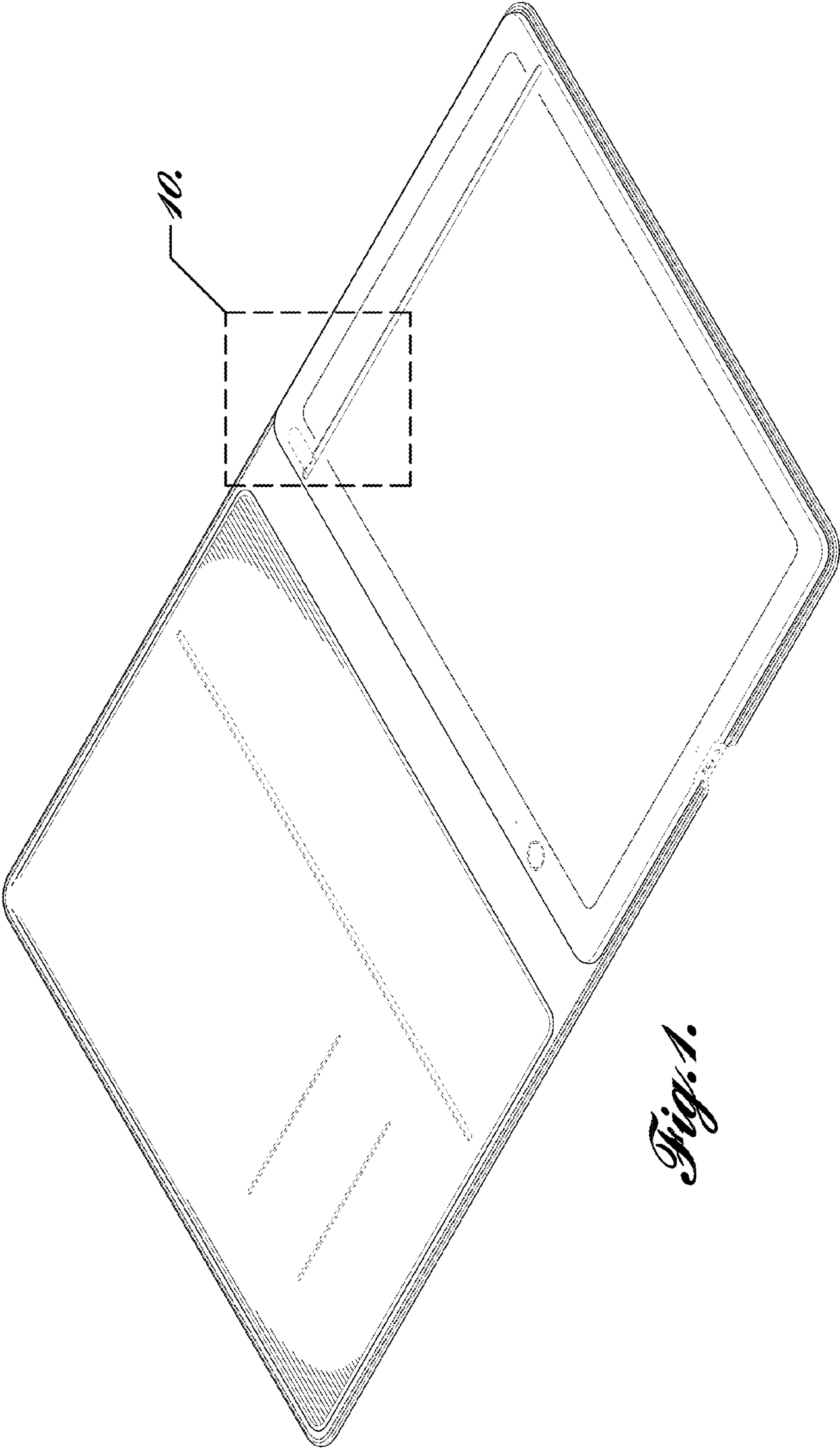
U.S. PATENT DOCUMENTS

D629,798	S	12/2010	Arie et al.	
D689,054	S	9/2013	Snyder	
D698,787	S	2/2014	Kim	
D710,349	S	8/2014	Han et al.	
D722,059	S	2/2015	Hirst	
9,035,872	B2	5/2015	Brown et al.	
D741,867	S	10/2015	Liu	
D742,873	S	11/2015	Ahn et al.	
D745,869	S	12/2015	Ahn et al.	
D751,546	S	3/2016	Guo et al.	
9,728,839	B2	8/2017	Gu et al.	
D796,515	S	9/2017	Kim et al.	
D808,949	S	1/2018	Zuniga et al.	
D823,309	S *	7/2018	Nishizawa .....	D14/440
D862,456	S *	10/2019	Nishizawa .....	D14/341
D863,292	S *	10/2019	Nishizawa .....	D14/341
D864,201	S *	10/2019	Nishizawa .....	D14/389

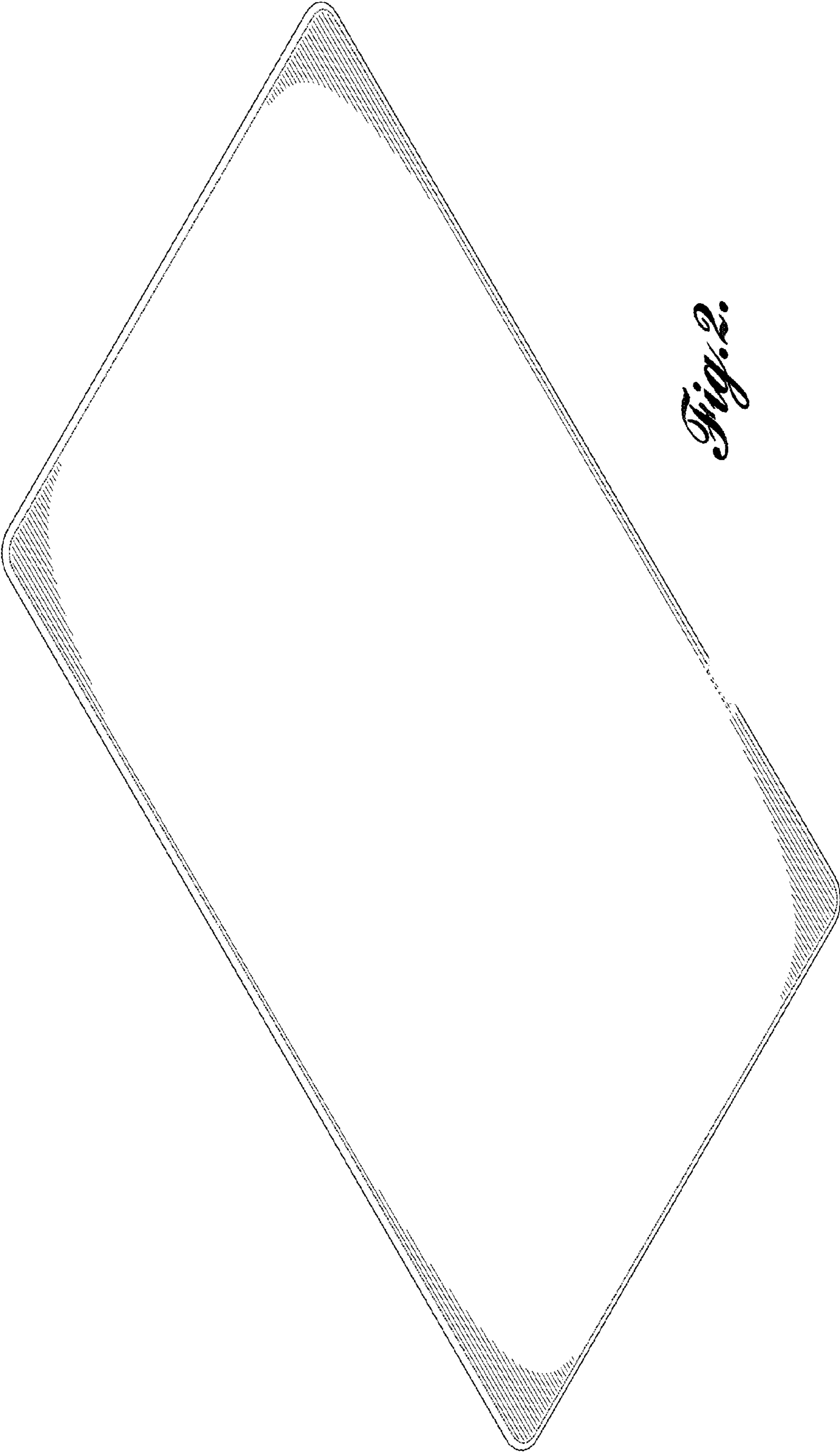
OTHER PUBLICATIONS

Artist Review: Wacom Bamboo Slate, posted Oct. 14, 2016 [retrieved May 11, 2018]. Retrieved from internet, <URL: <https://www.youtube.com/watch?v=8NWEwUVEyZs> >.  
 Wacom Bamboo Folio and Bamboo Slate Review, posted Aug. 8, 2016, [retrieved May 11, 2018]. Retrieved from Internet <URL: <https://www.laptopmag.com/reviews/accessories/wacom-bamboo-folio-and-slate#> >.  
 Wacom Bamboo smart notepads review: Wacom's smart notepads slowly bridge the digital note-taking divide, posted Sep. 1, 2016, [retrieved May 11, 2018]. Retrieved from Internet, <URL: <https://www.cnet.com/products/wacom-bamboo-smart-notepads/review/> >.  
 Moleskine Tablet Cover for iPad Air with Volant Reporter Notebook, posted Apr. 15, 2015, [retrieved May 11, 2018]. Retrieved from Internet, <URL: <http://gadgets.in.com/moleskine-tablet-cover-for-ipad-air-with-volant-reporter-notebook.html> >.

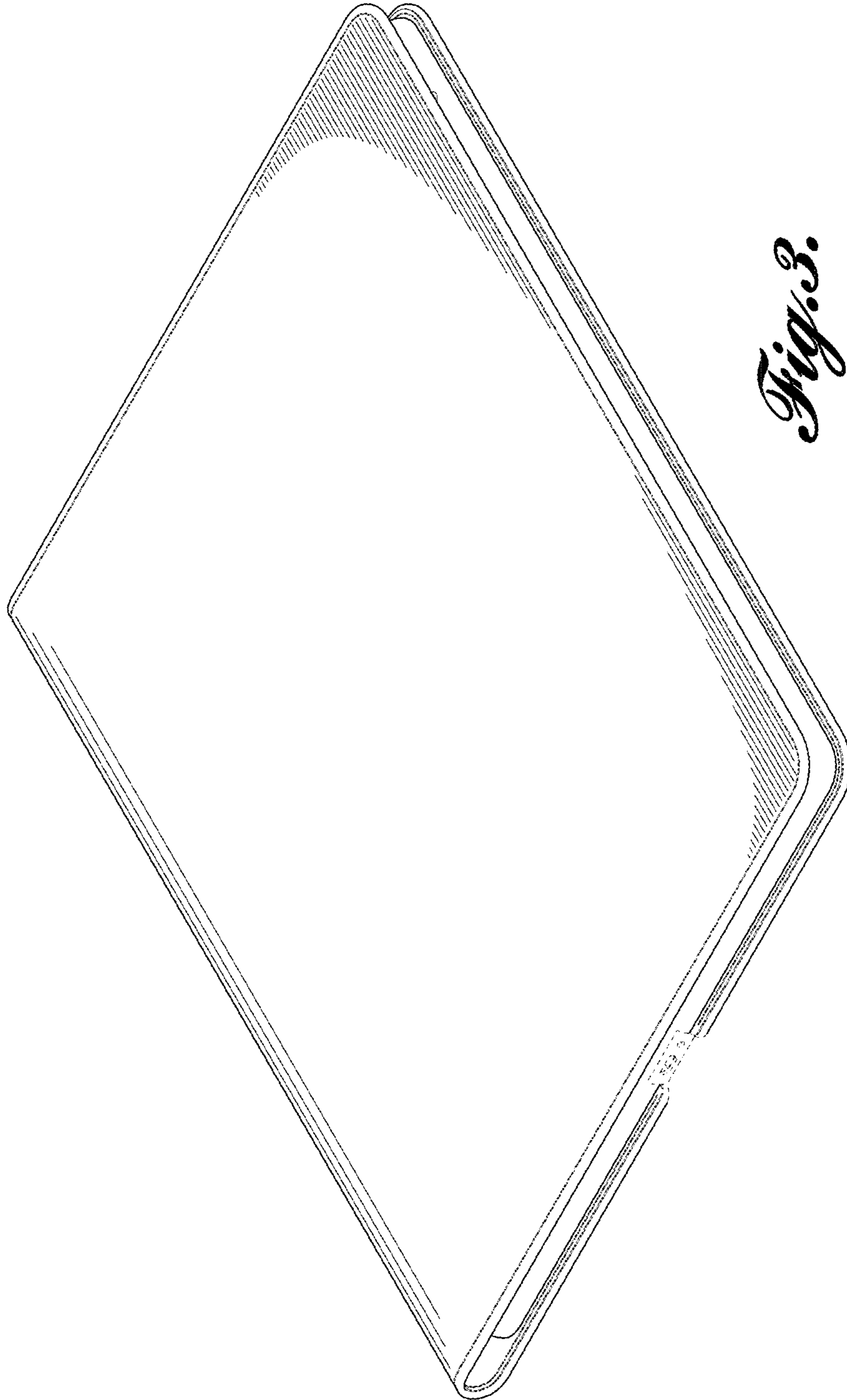
\* cited by examiner

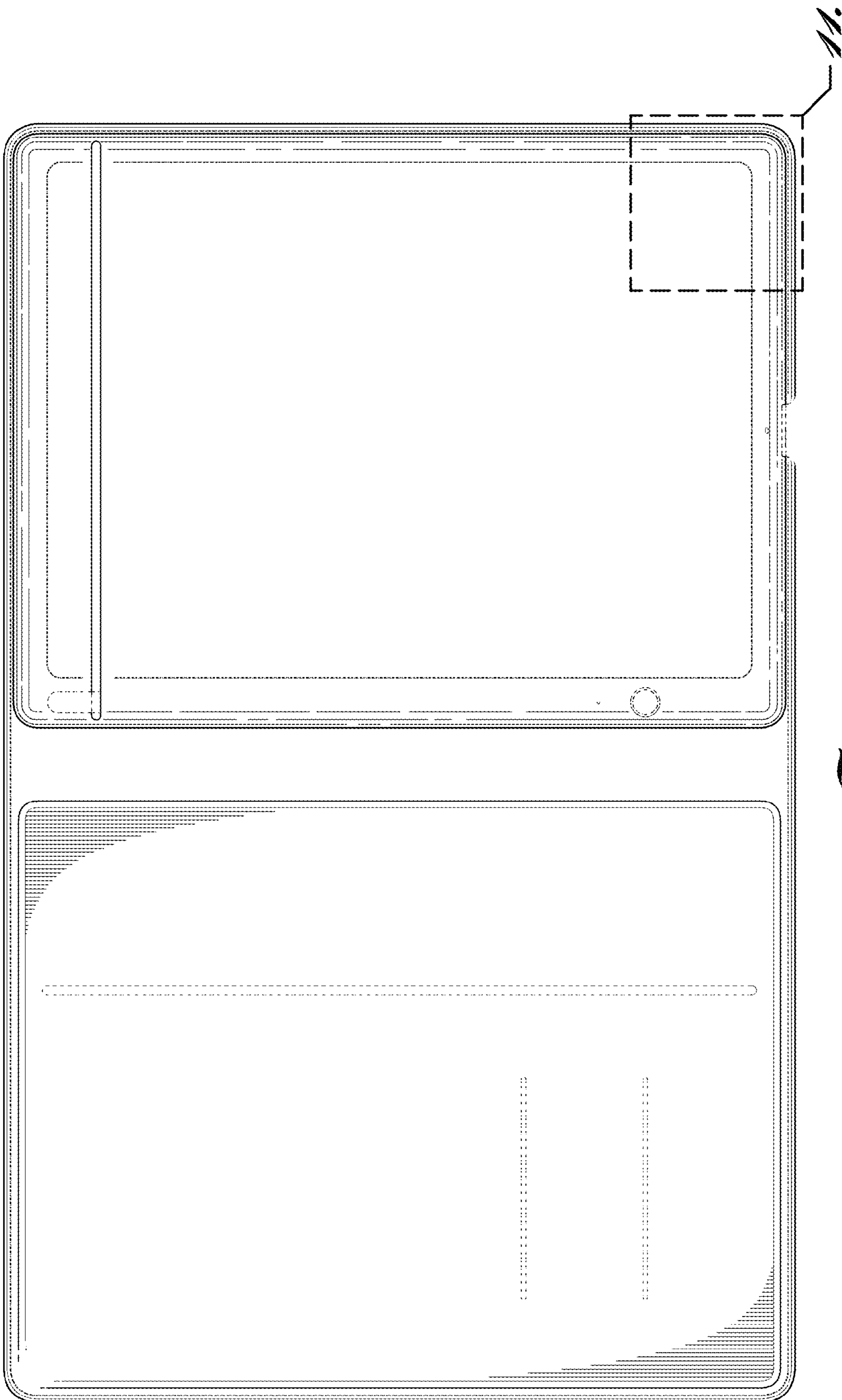


*Fig. 1.*

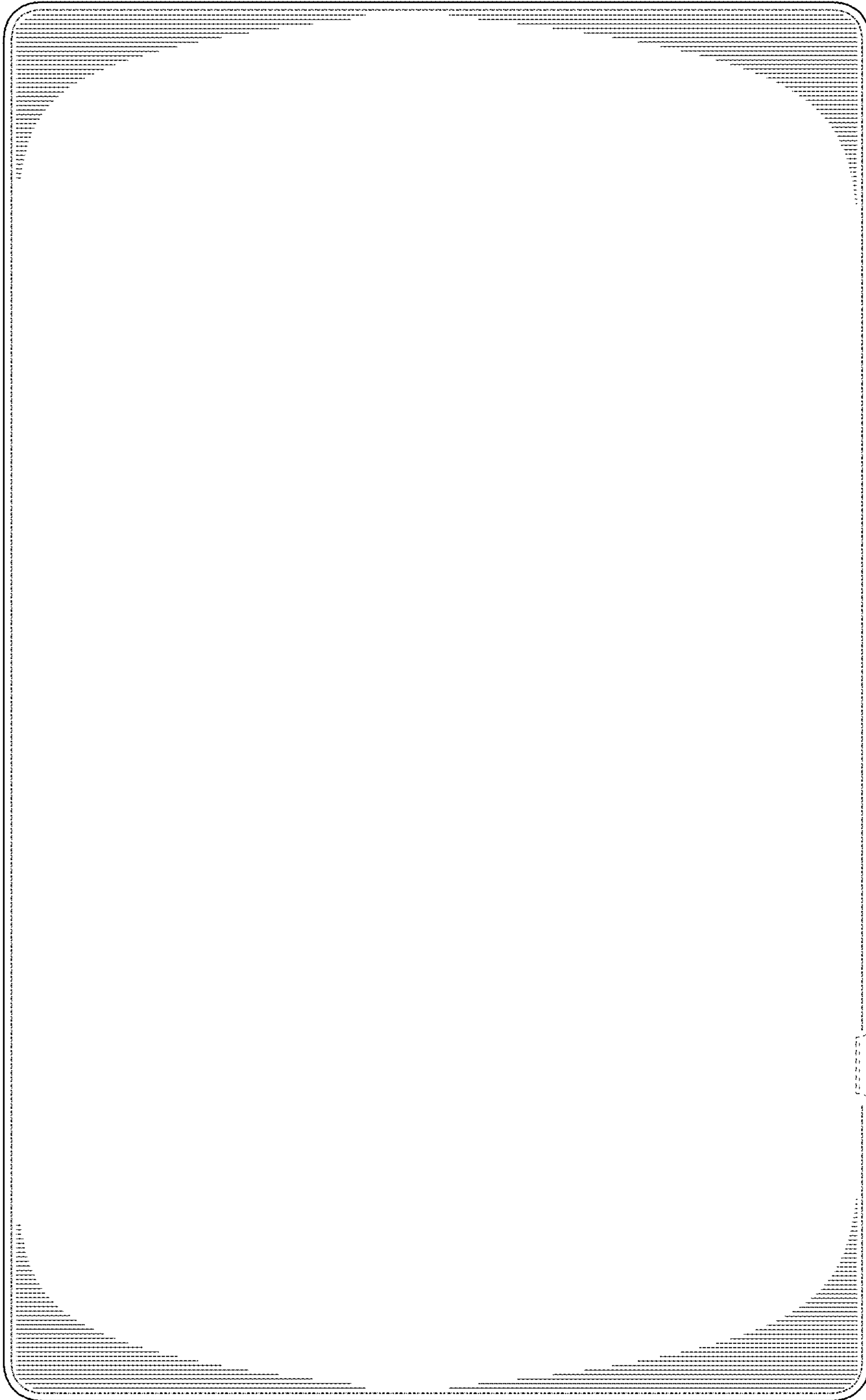


*Fig. 2.*

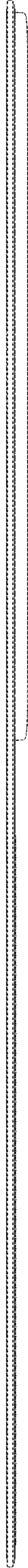




*Fig. 4.*



*Fig. 5.*



*Fig. 6.*

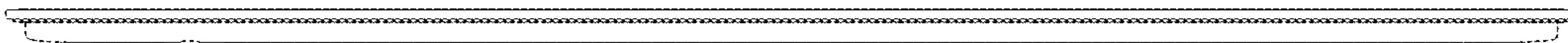


*Fig. 7.*



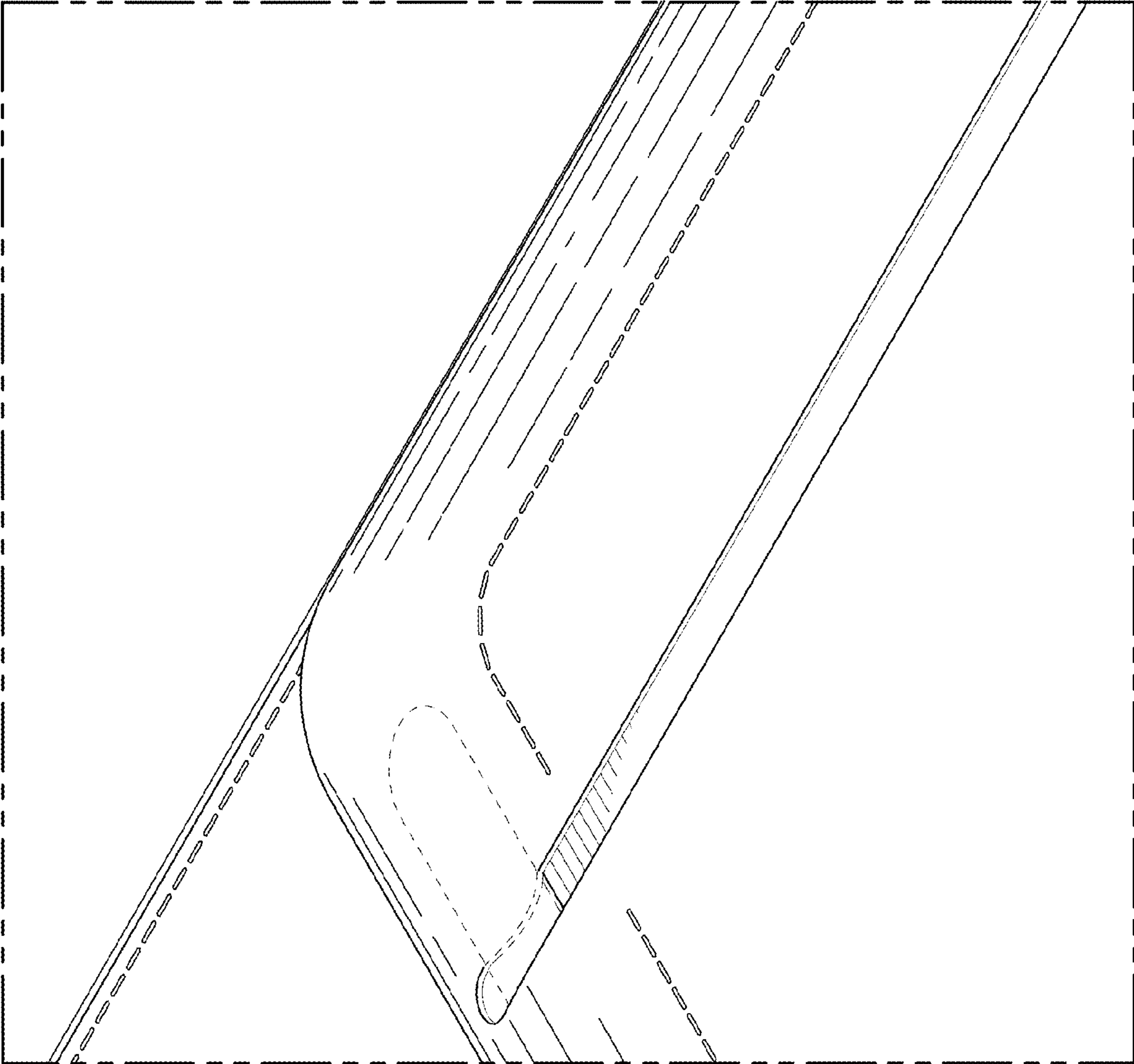


*Fig. 9.*

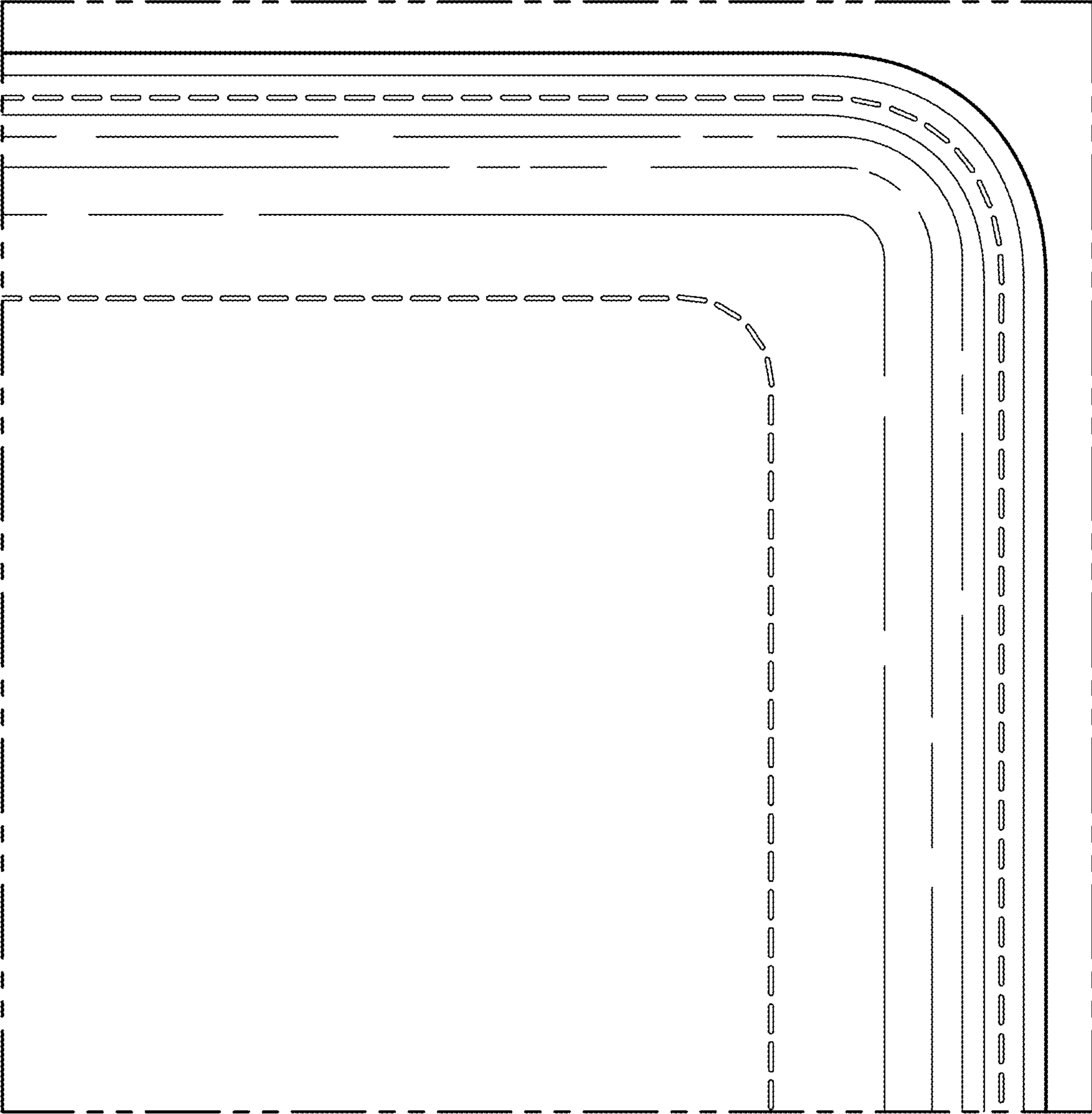


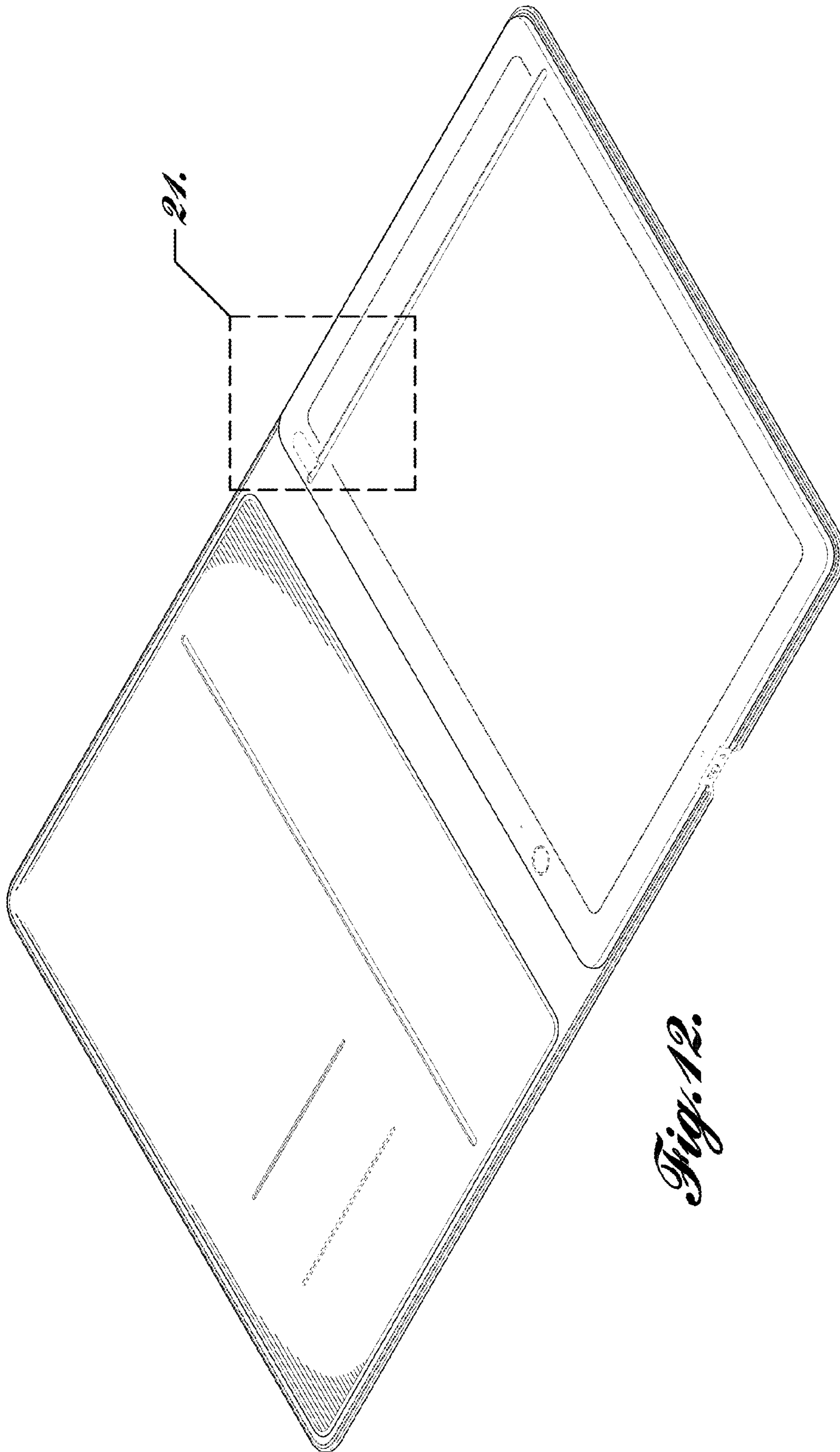
*Fig. 8.*

*Fig. 10.*

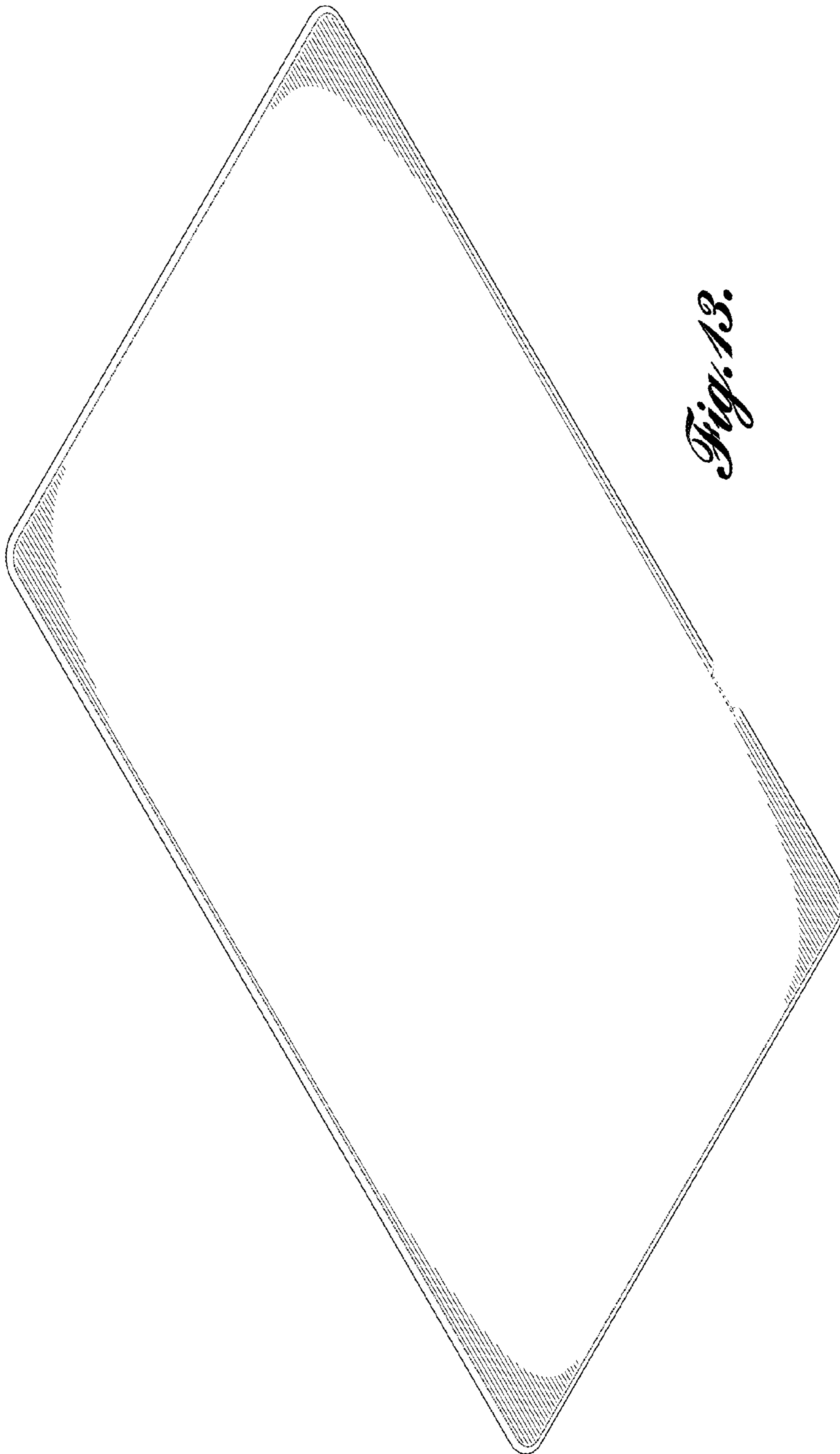


*Fig. 11.*

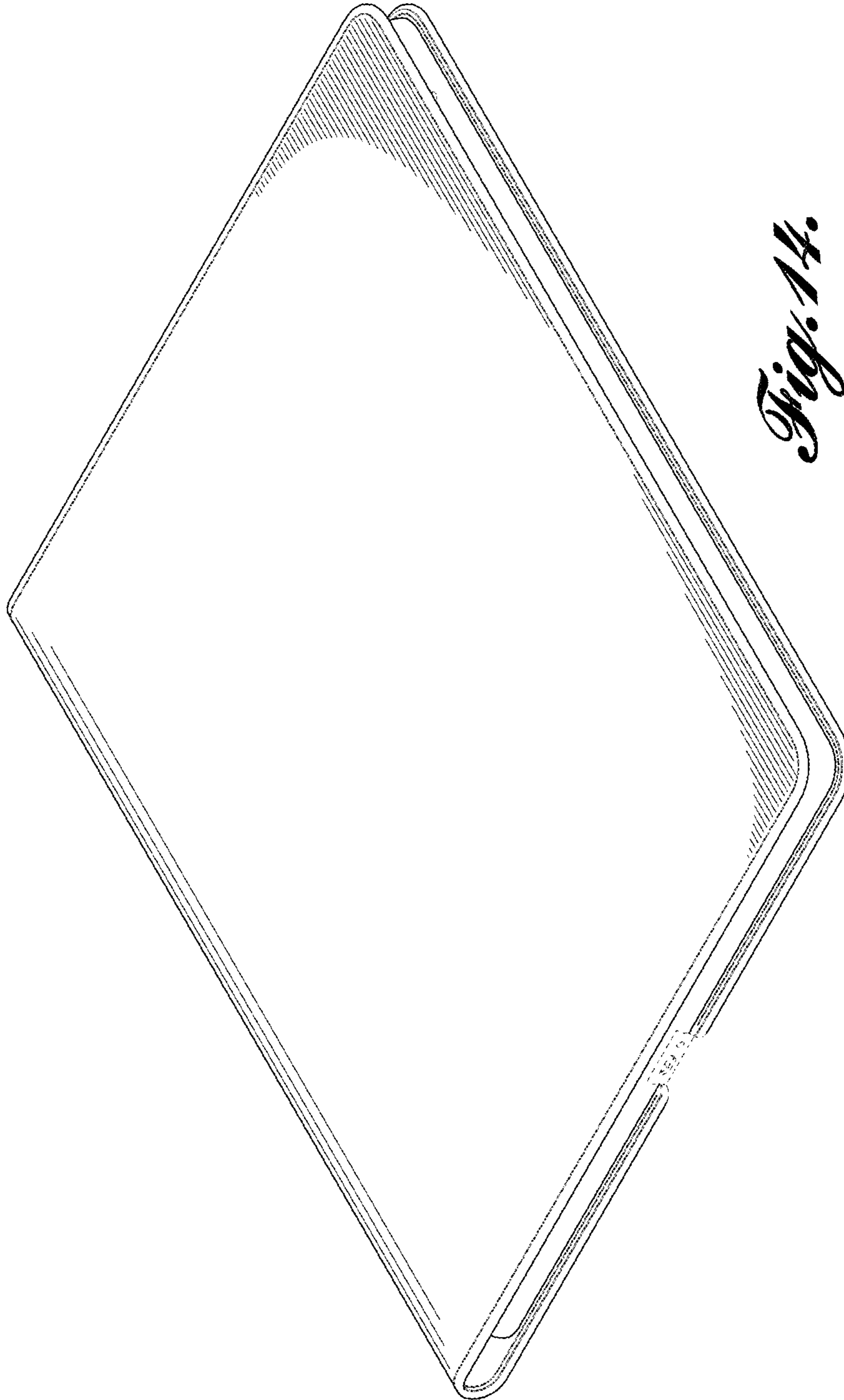


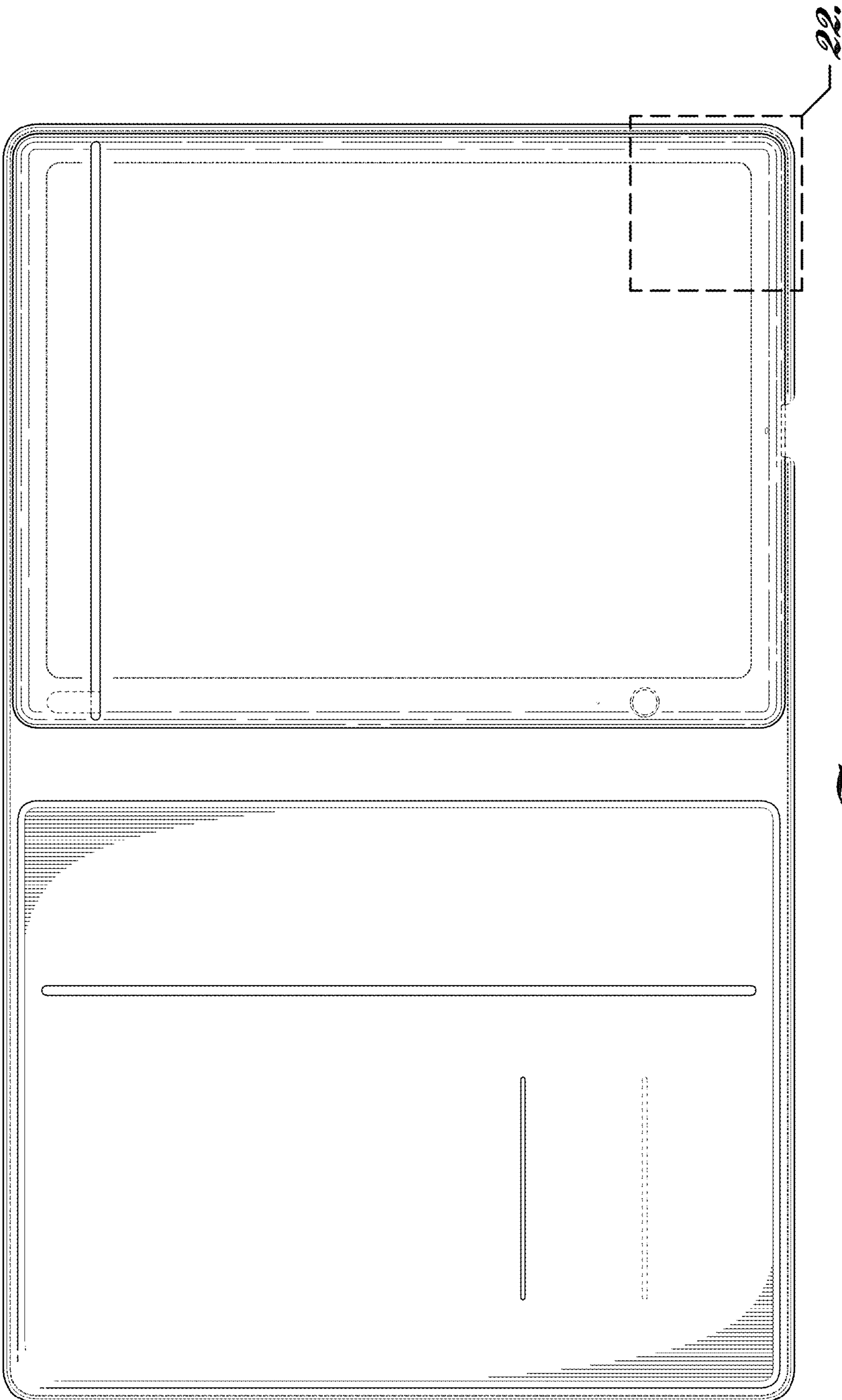


*Fig. 12.*

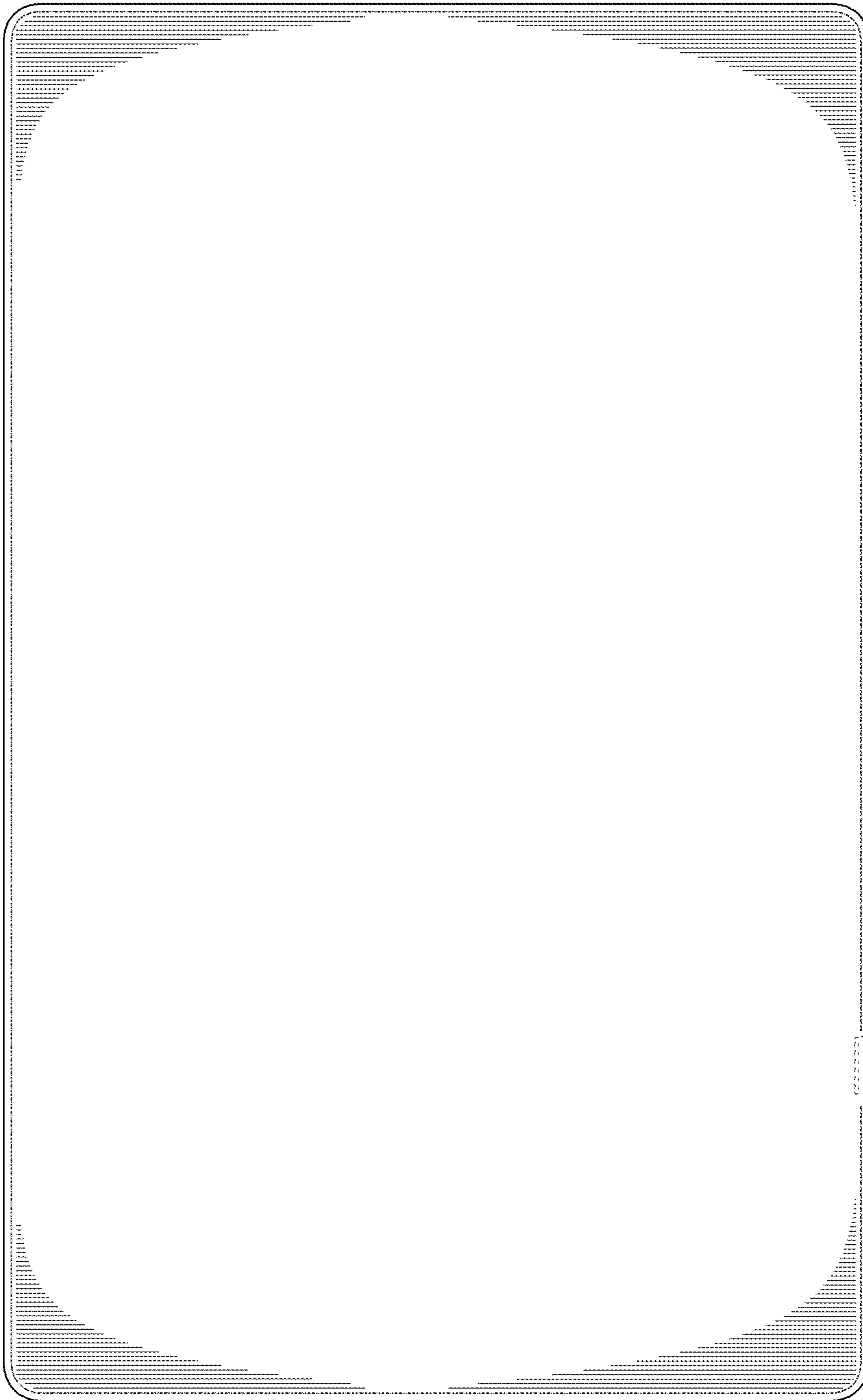


*Fig. 13.*



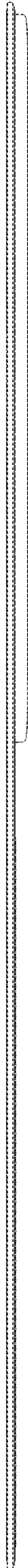


*Fig. 15.*



*Fig. 16.*

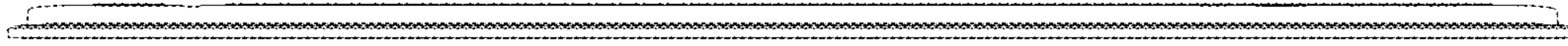




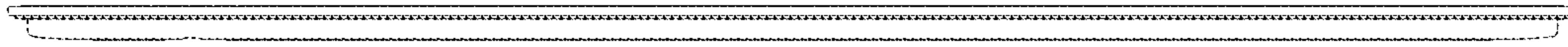
*Fig. 17.*



*Fig. 18.*

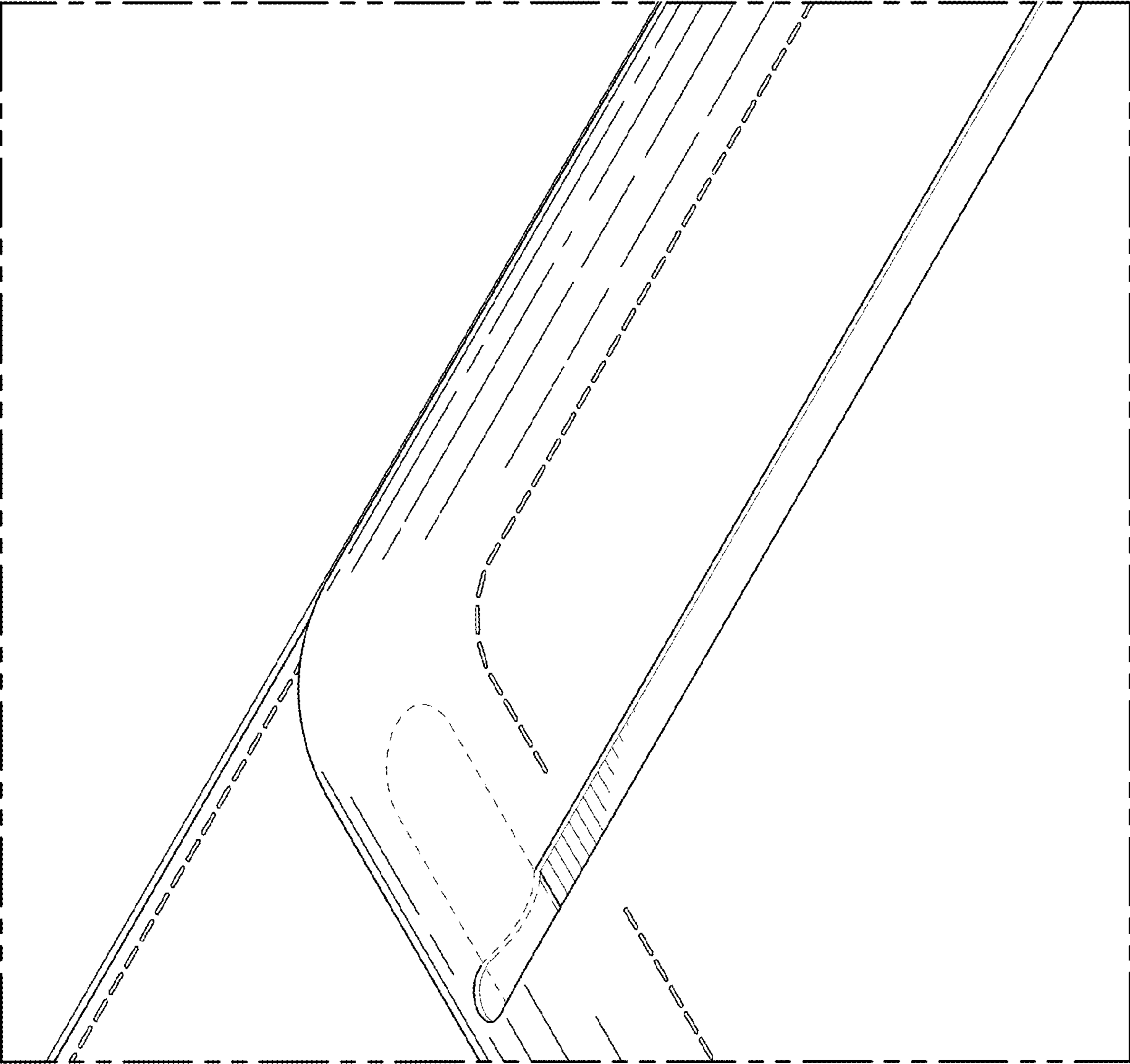


*Fig. 20.*



*Fig. 19.*

*Fig. 21.*



*Fig. 22.*

