



US00D886769S

(12) **United States Design Patent**
Poulheim

(10) **Patent No.:** **US D886,769 S**

(45) **Date of Patent:** **** Jun. 9, 2020**

(54) **LOUDSPEAKER**

(71) Applicant: **Bang & Olufsen A/S**, Struer (DK)

(72) Inventor: **Andre Poulheim**, Huerth (DE)

(73) Assignee: **Bang & Olufsen A/S**, Struer (DK)

(**) Term: **15 Years**

(21) Appl. No.: **29/625,612**

(22) Filed: **Nov. 10, 2017**

(51) **LOC (12) Cl.** **14-01**

(52) **U.S. Cl.**

USPC **D14/204**

(58) **Field of Classification Search**

USPC D14/167, 168, 170–172, 188, 204, 210,
D14/214; 181/143, 144, 148, 153, 157,
181/198, 199; 369/6–12; 381/300–303,
381/361–364, 366, 386–388

CPC H04R 1/02; H04R 1/021; H04R 1/025;
H04R 1/026; H04R 1/028; H04R 1/403;
H04R 1/2803; H04R 1/2834; H04R 5/02;
H04R 9/06; H04R 19/013; H04R
2400/00; G06F 1/1688

See application file for complete search history.

(56) **References Cited**

U.S. PATENT DOCUMENTS

3,931,867	A *	1/1976	Janszen	H04R 1/24 181/155
D334,193	S *	3/1993	Jewitt	D14/213
D358,392	S *	5/1995	Yamazaki	D14/213
D484,490	S *	12/2003	Lewis	D14/216
D497,355	S *	10/2004	Bhavnani	D14/188
D538,112	S *	3/2007	Jeffrey	D7/612
D575,770	S *	8/2008	Lewis	D14/216
D580,913	S *	11/2008	Omori	D14/215
D608,349	S *	1/2010	Wang	D14/216
D634,733	S *	3/2011	Lewis	D14/216
D667,389	S *	9/2012	Yokoyama	D14/204

D679,678	S *	4/2013	Uesugi	D14/213
D700,591	S *	3/2014	Xiao	D14/216
D723,514	S *	3/2015	Lukic	D14/213
D754,099	S *	4/2016	Sung	D14/209.1

(Continued)

Primary Examiner — Janice Patyk

(74) *Attorney, Agent, or Firm* — Dykema Gossett PLLC

(57) **CLAIM**

The ornamental design for a loudspeaker, as shown and described.

DESCRIPTION

FIG. 1 is a top, front, right side isometric view of a loudspeaker, showing my new design;

FIG. 2 is a top, rear, left side isometric view thereof;

FIG. 3 is a front view thereof;

FIG. 4 is a rear view thereof;

FIG. 5 is a right side view thereof;

FIG. 6 is a left side view thereof;

FIG. 7 is a top plan view thereof, shown in enlarged scale, and the top plan view of FIGS. 9 and 12 being identical thereof;

FIG. 8 is a bottom plan view thereof, shown in enlarged scale, and the top plan views of FIGS. 9 and 12 being identical thereof;

FIG. 9 is a top, front, right side isometric view thereof;

FIG. 10 is a left side view thereof;

FIG. 11 is a rear view thereof;

FIG. 12 is a top, front, right side isometric view thereof, shown with the top extended and the acoustic lens is not in the deployed condition;

FIG. 13 is a top, rear, left side isometric view thereof;

FIG. 14 is a front view thereof;

FIG. 15 is a right side view thereof; and,

FIG. 16 is a left side view thereof.

The broken lines in the figures illustrate the portions of the design that form no part of the claimed design.

1 Claim, 16 Drawing Sheets

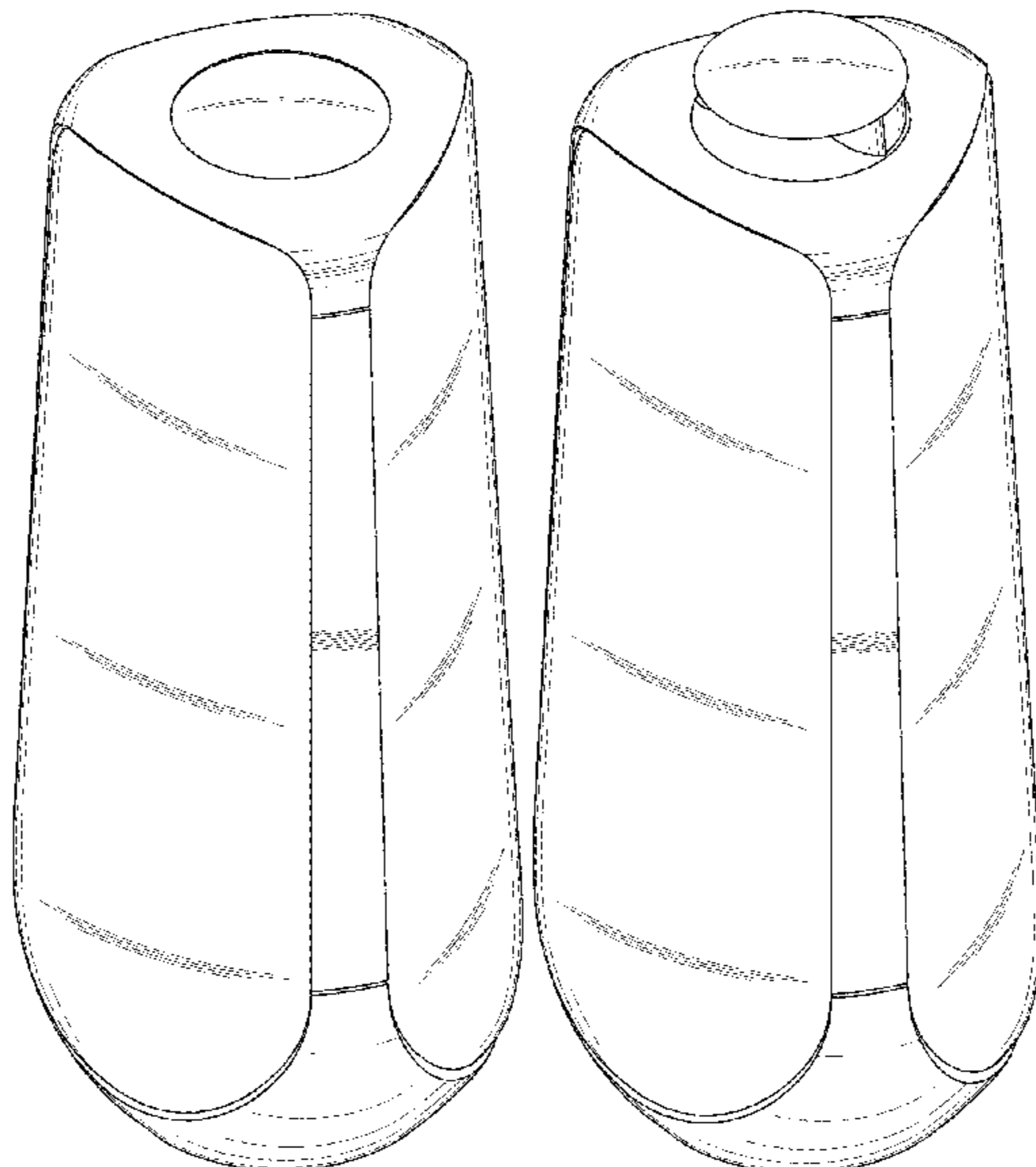

(56)

References Cited

U.S. PATENT DOCUMENTS

D766,878 S * 9/2016 Park D14/216
D767,536 S * 9/2016 Park D14/216

* cited by examiner

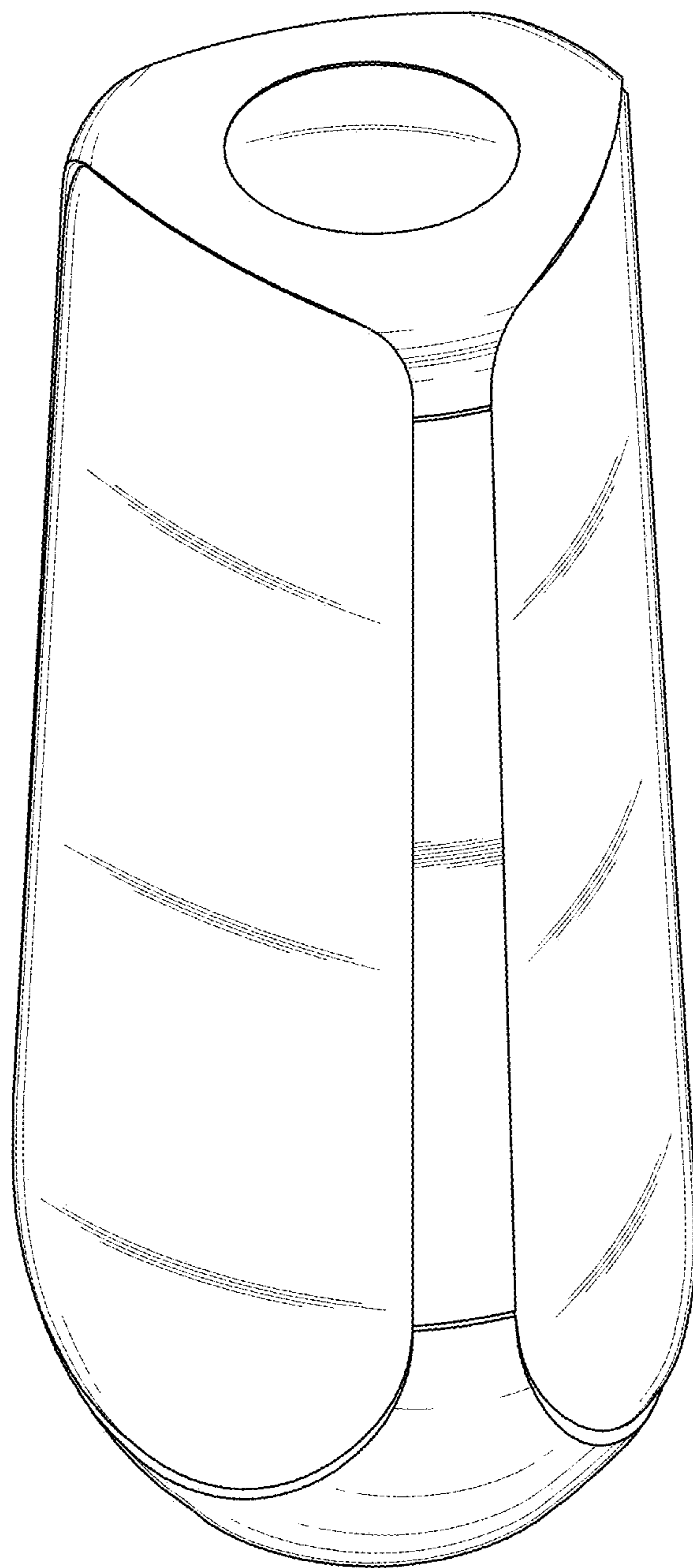

FIG. 1

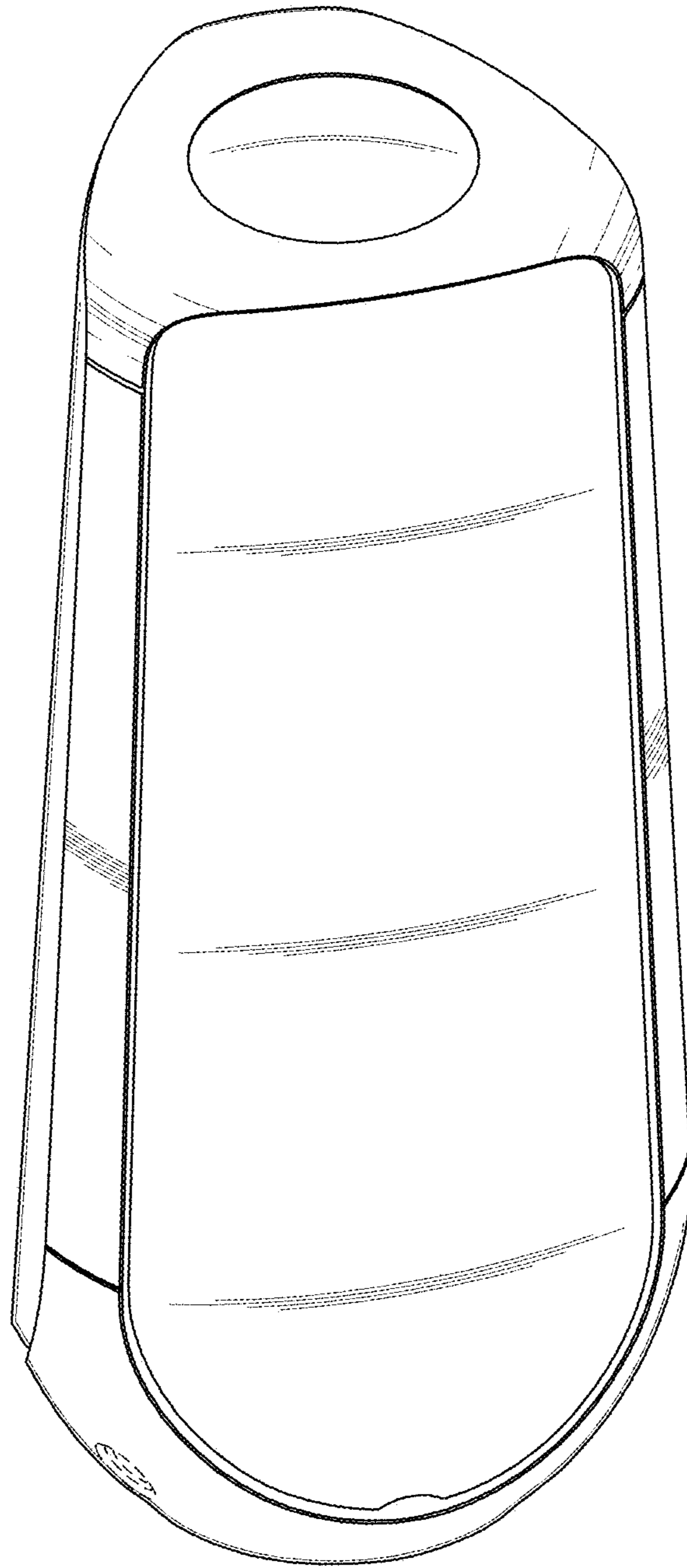

FIG. 2

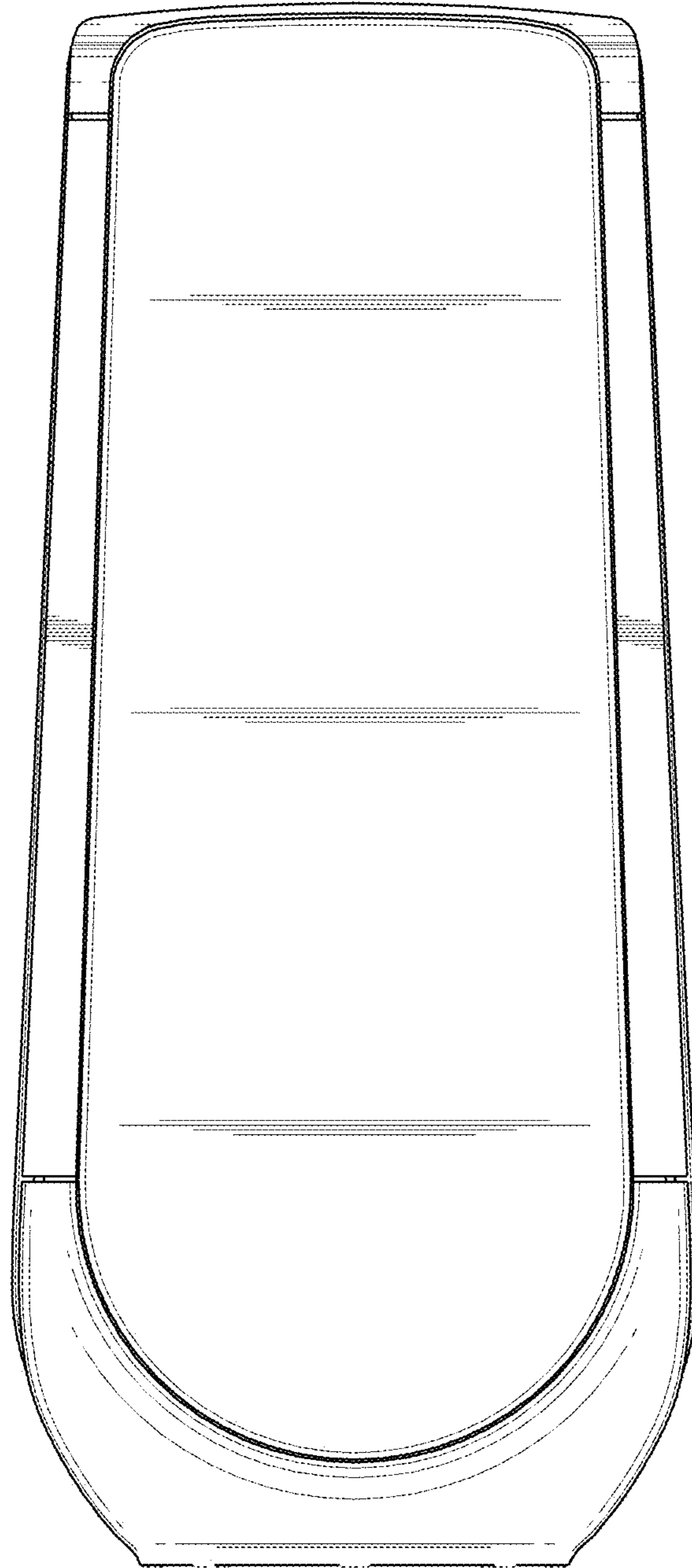

FIG. 3

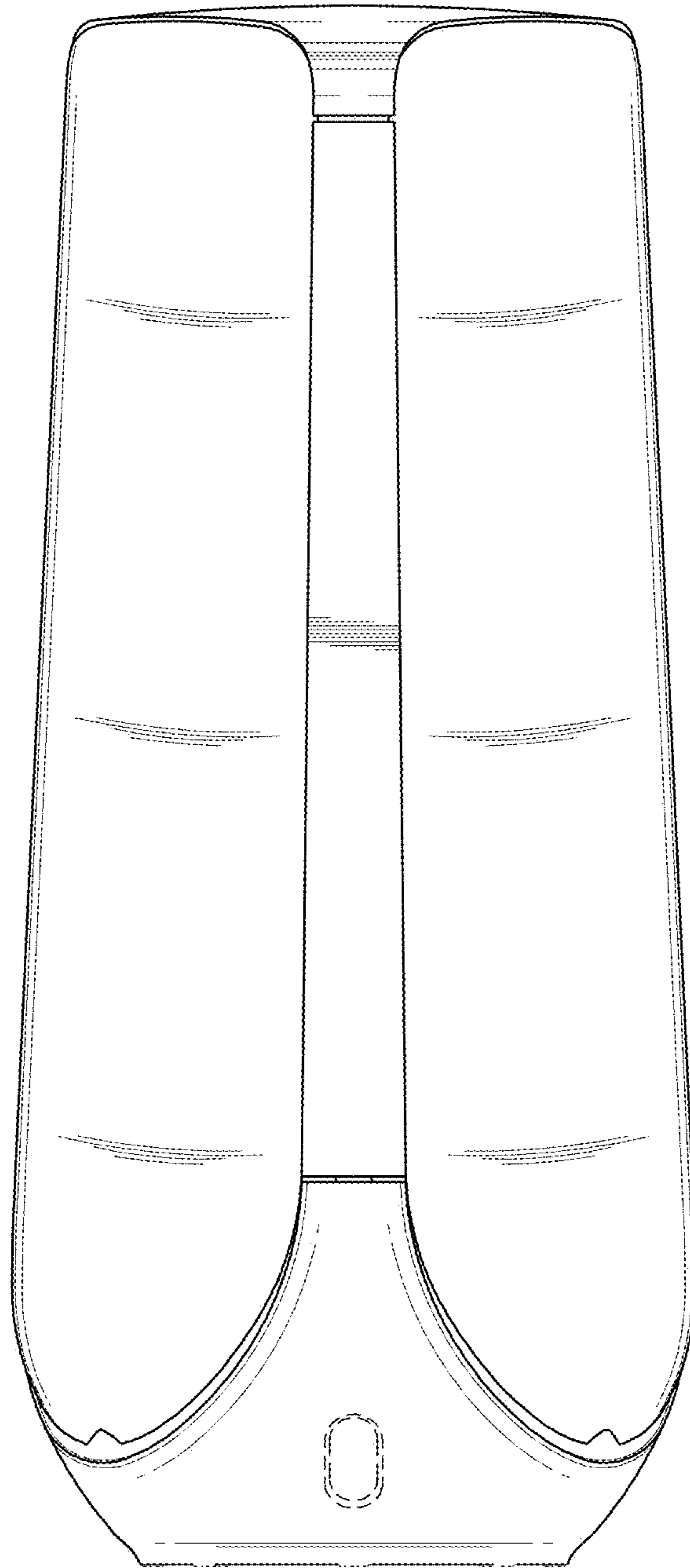

FIG. 4

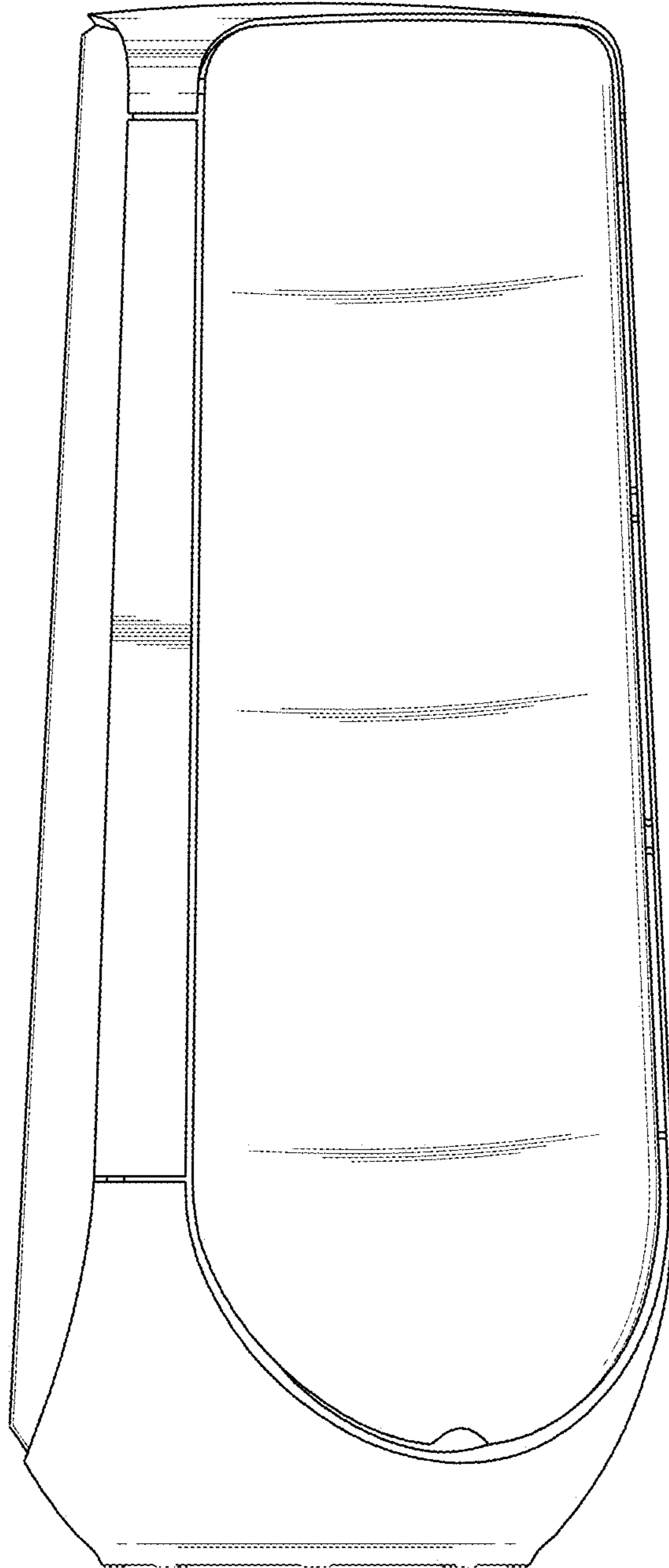

FIG. 5

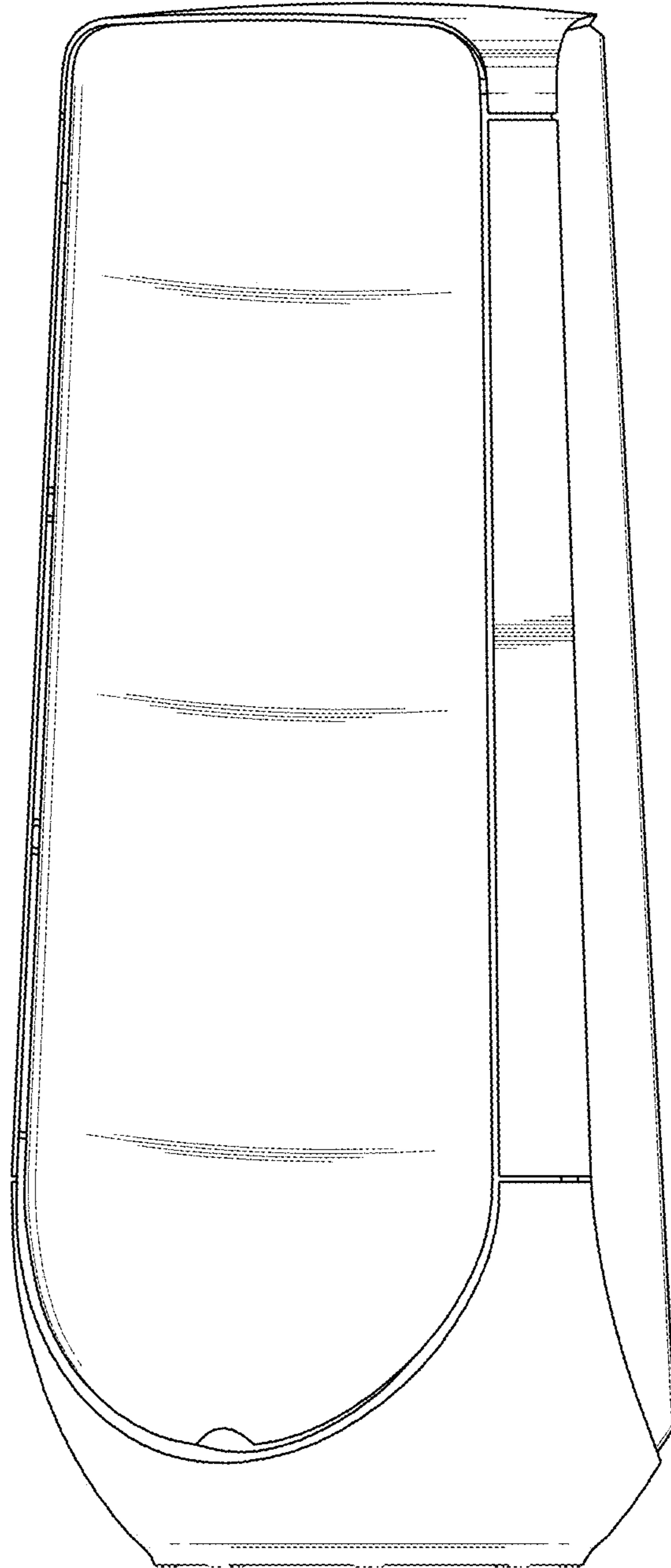

FIG. 6

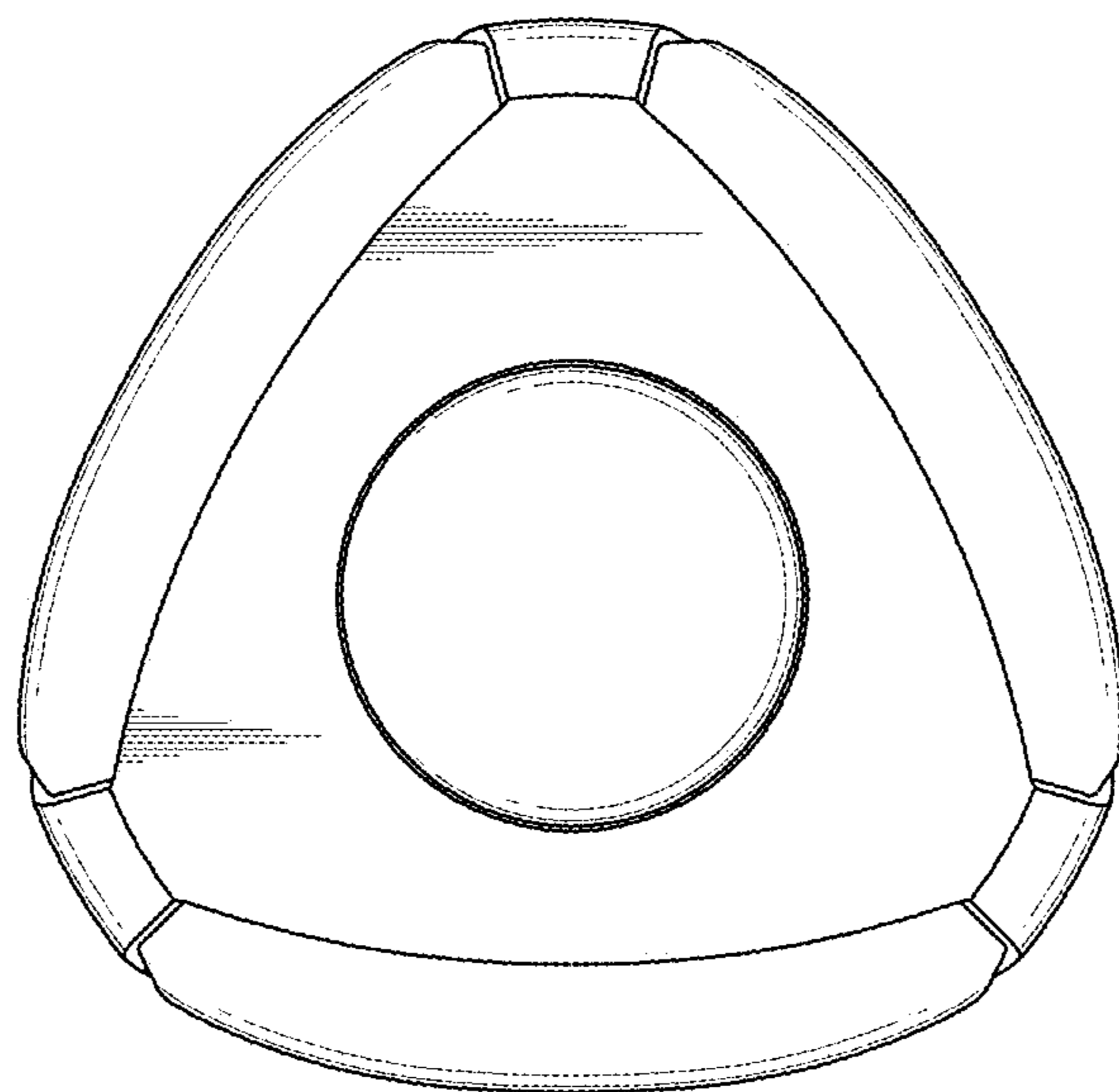

FIG. 7

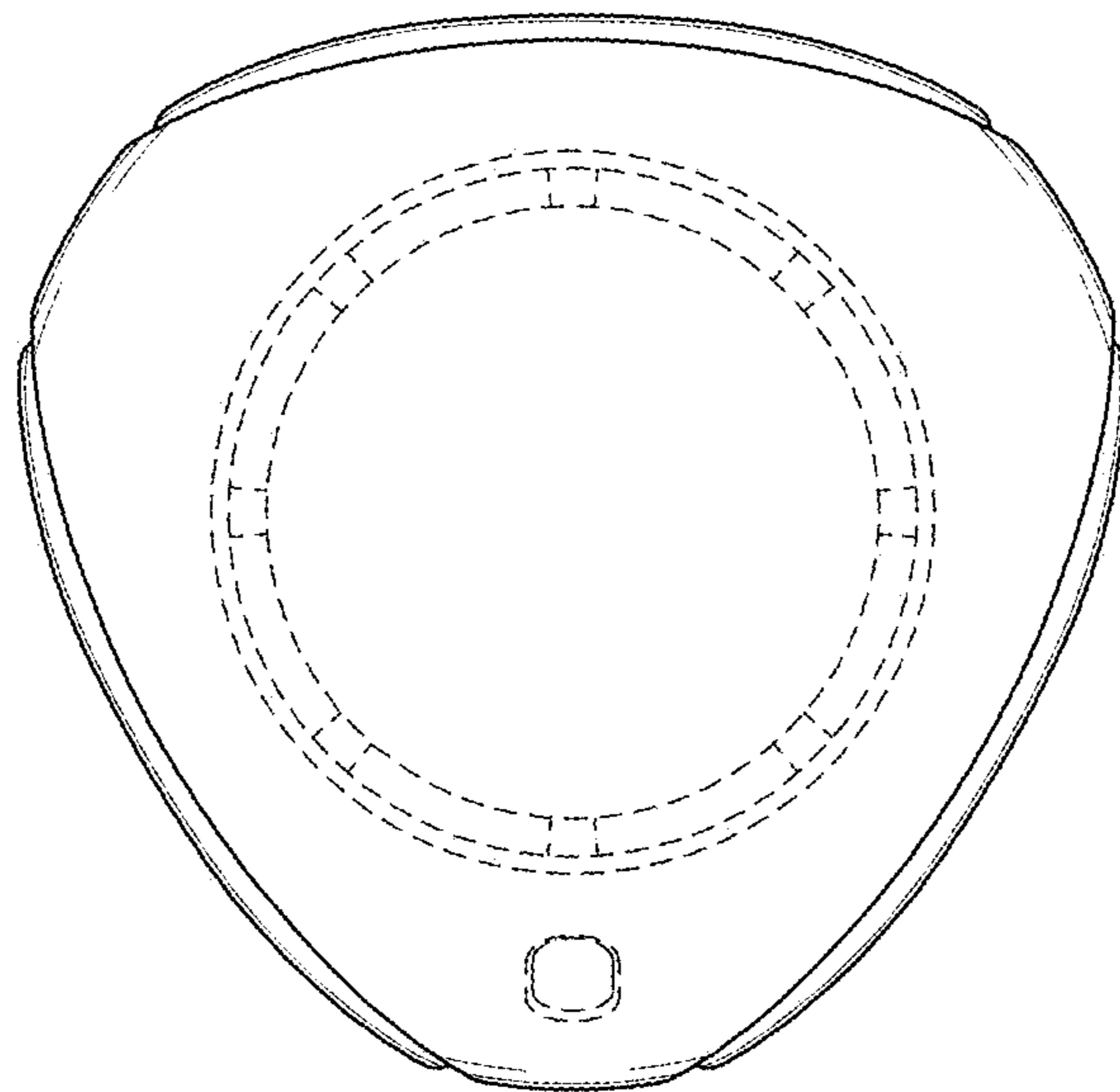

FIG. 8

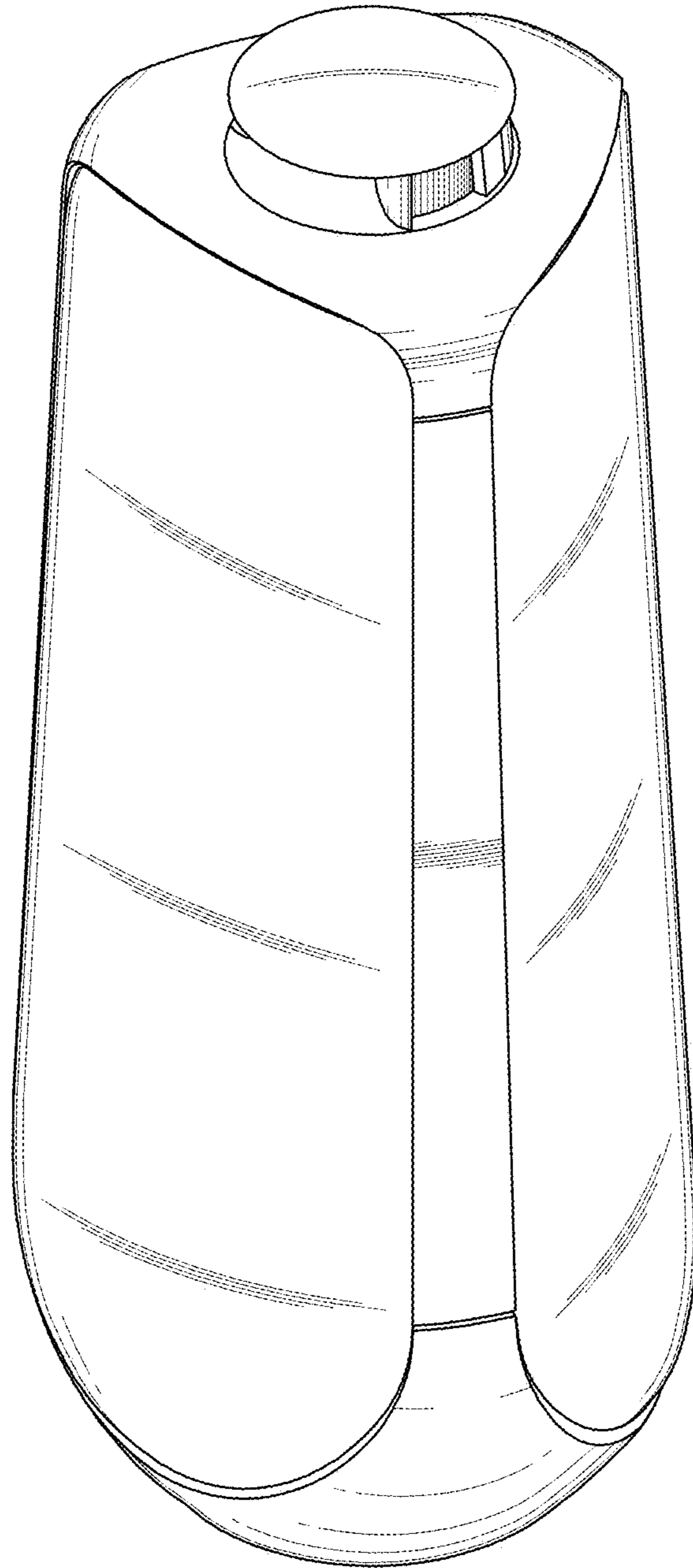

FIG. 9

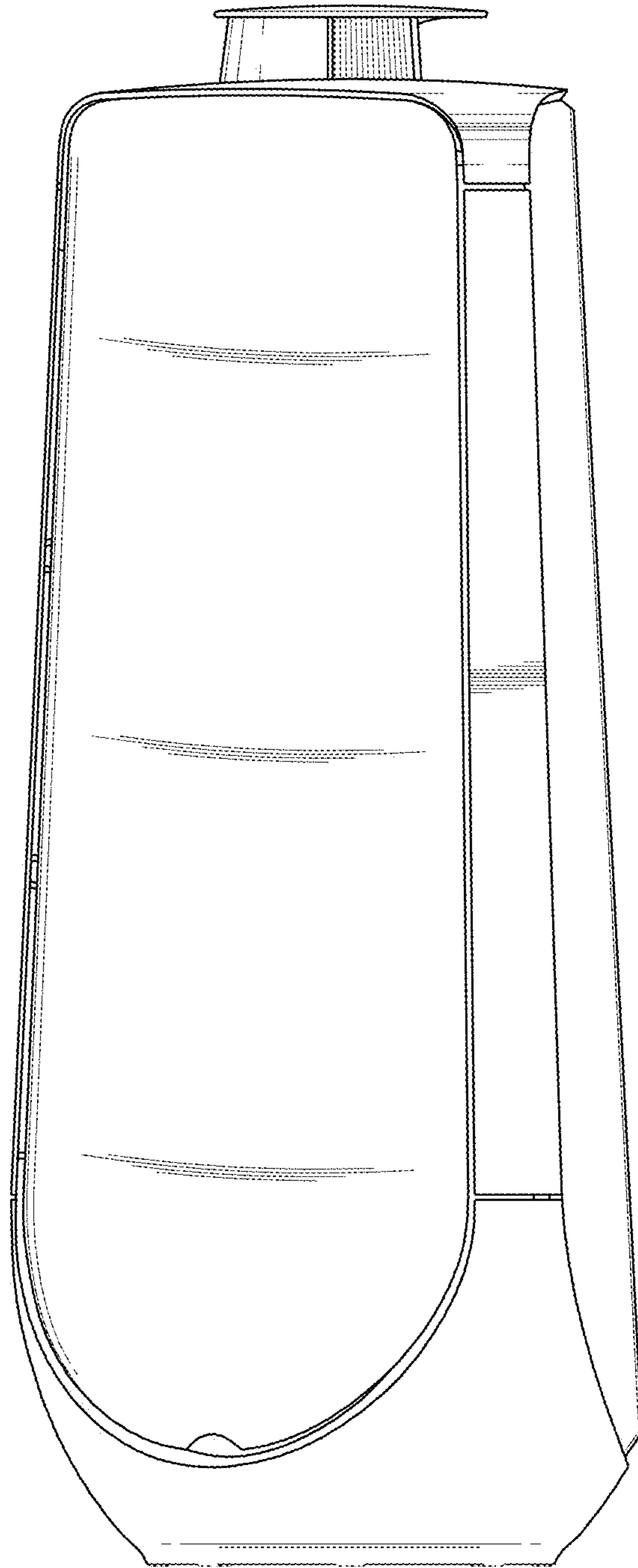

FIG. 10

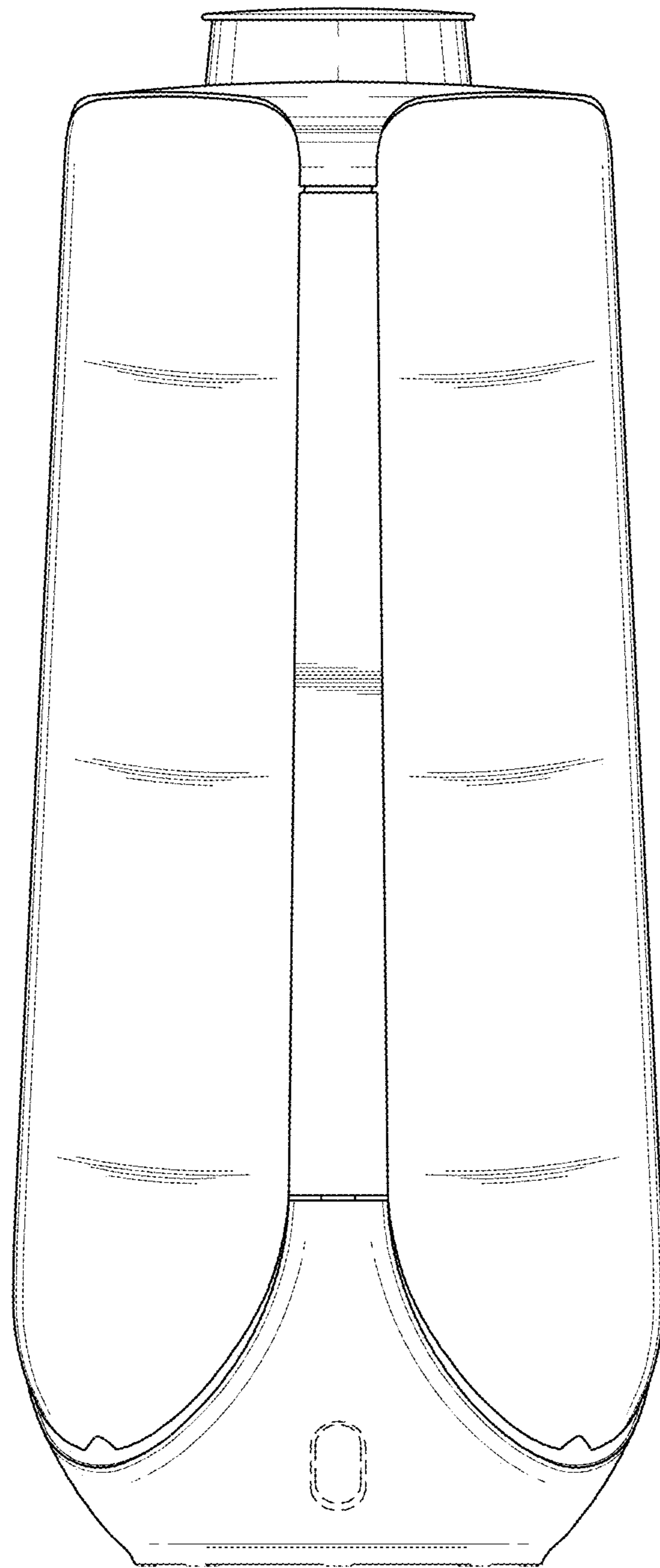

FIG. 11

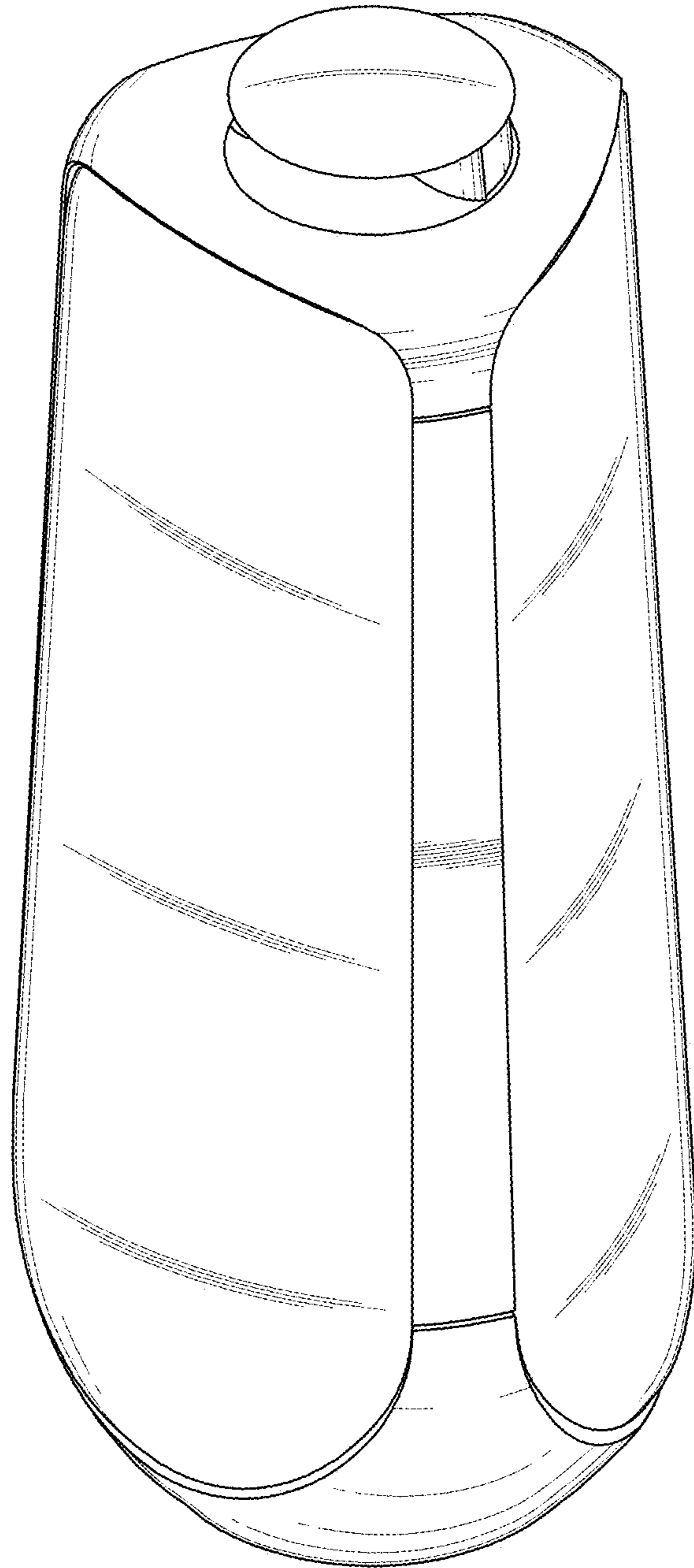

FIG. 12

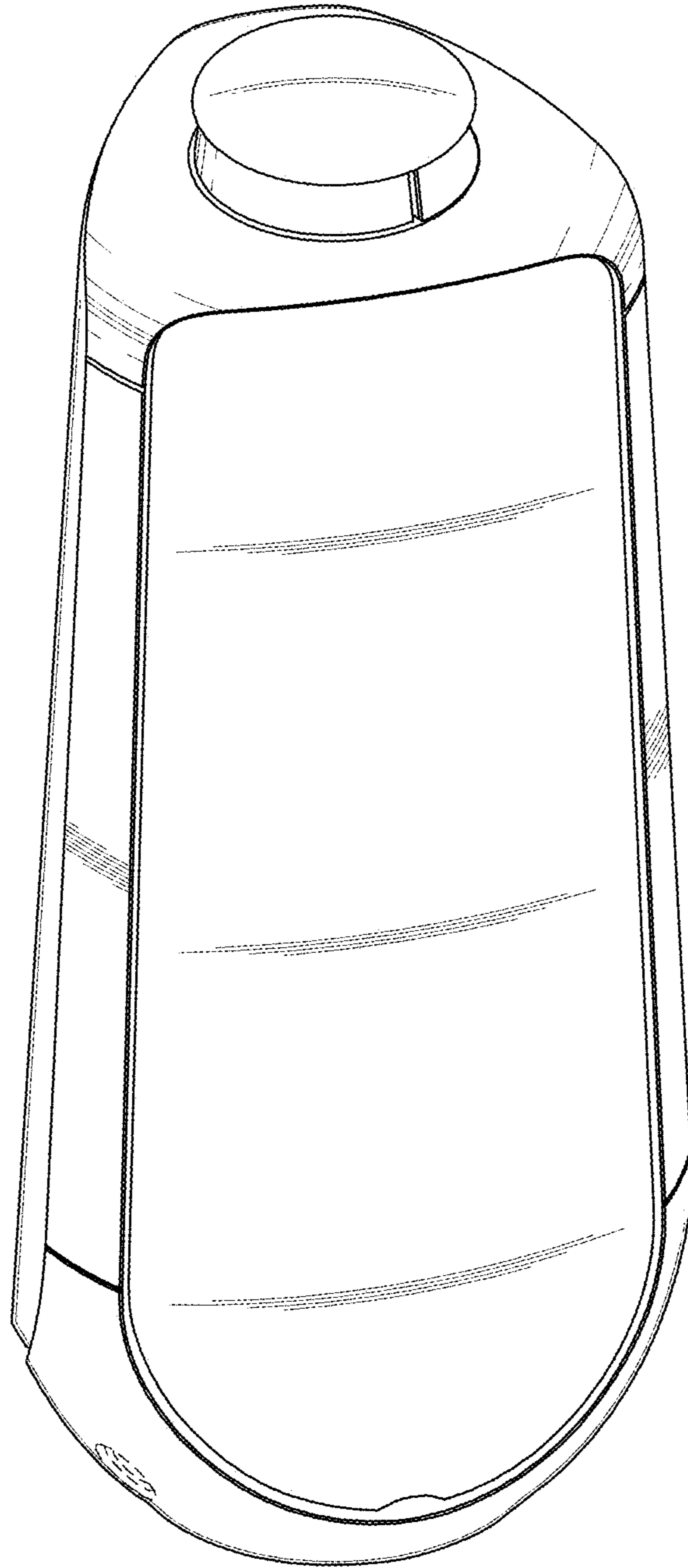

FIG. 13

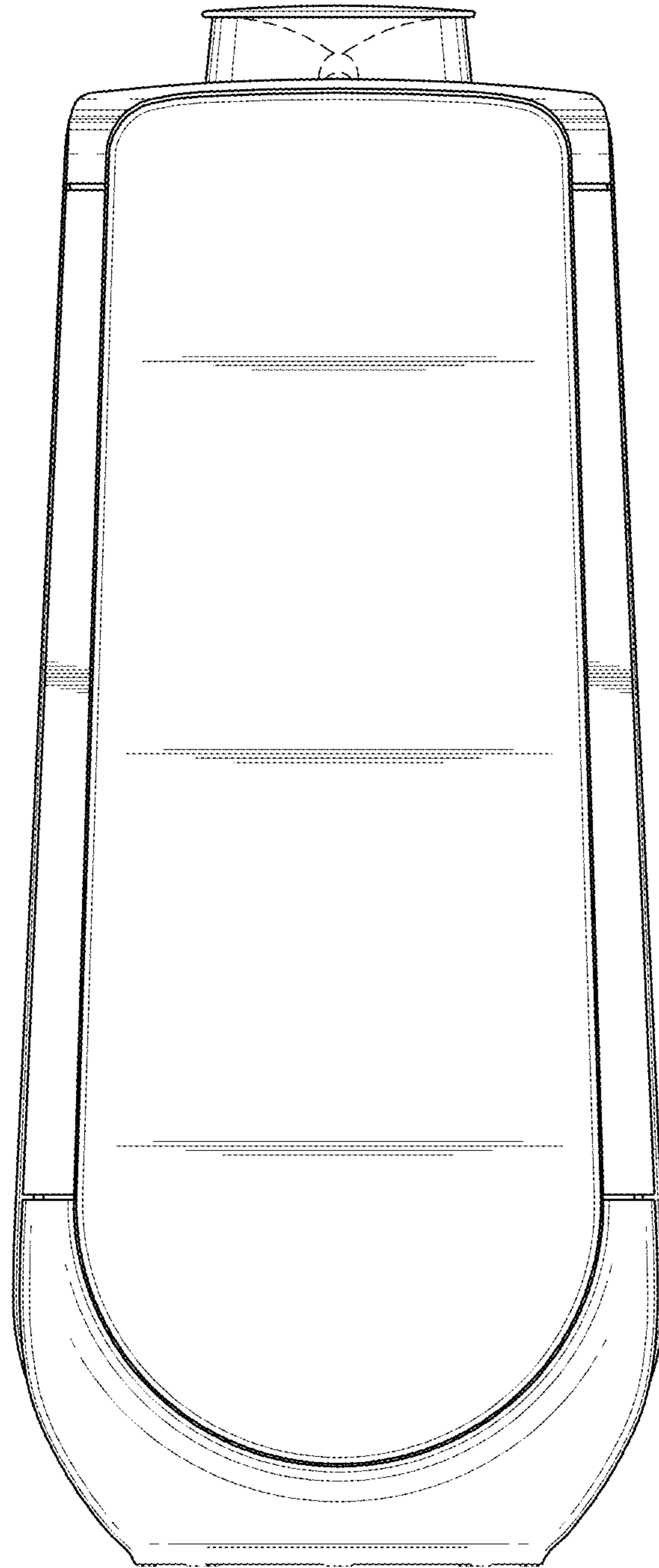

FIG. 14

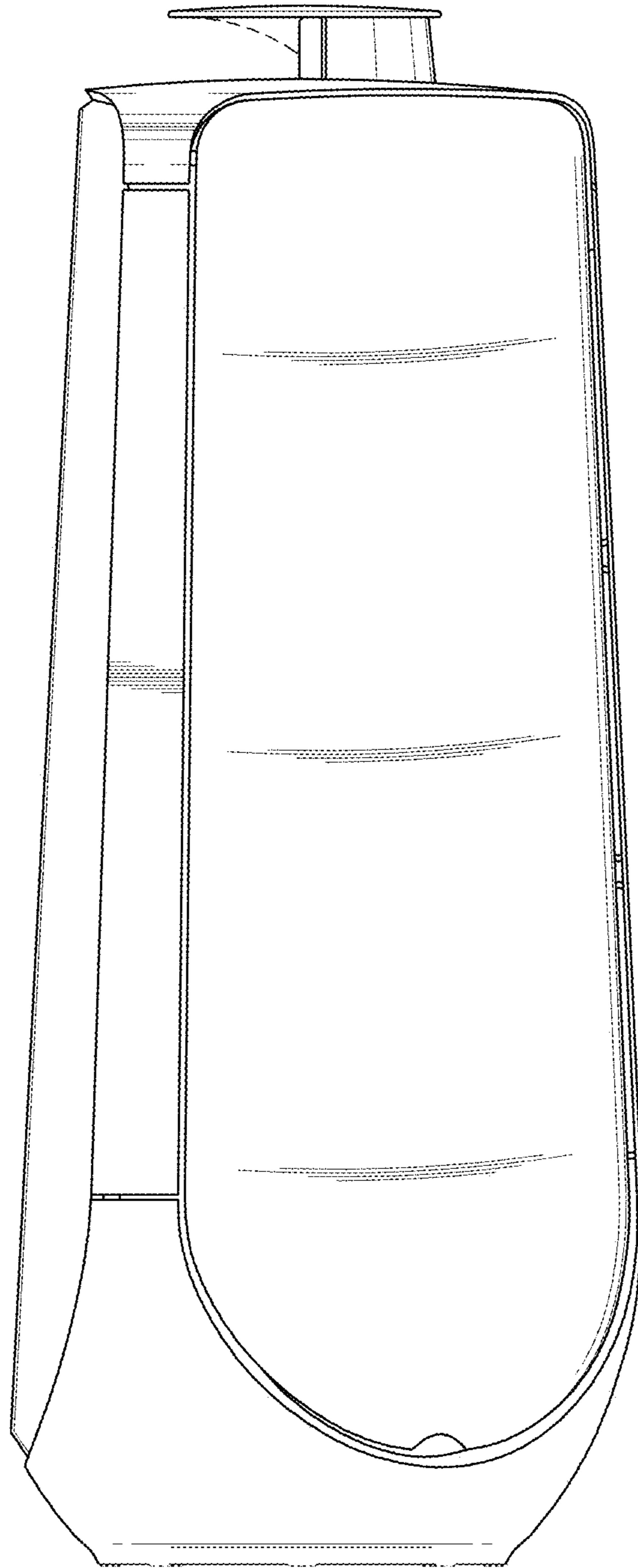

FIG. 15

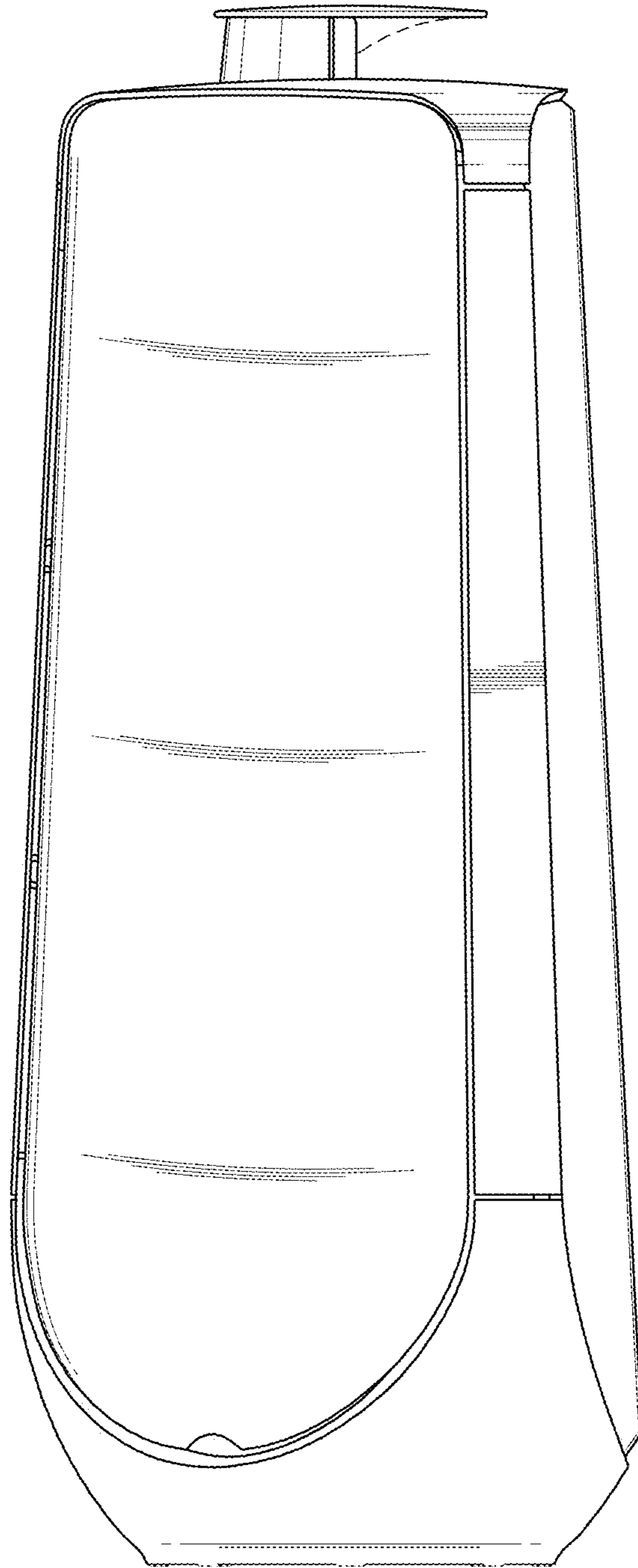

FIG. 16