



US00D886760S

(12) **United States Design Patent**  
**Hong**

(10) **Patent No.:** **US D886,760 S**  
(45) **Date of Patent:** **\*\* Jun. 9, 2020**

(54) **RECEIVER**

(71) Applicant: **HORIZON HOBBY, LLC,**  
Champaign, IL (US)

(72) Inventor: **Adam Hong,** Champaign, IL (US)

(73) Assignee: **Horizon Hobby, LLC,** Champaign, IL  
(US)

(\*\*) Term: **15 Years**

(21) Appl. No.: **29/622,136**

(22) Filed: **Oct. 13, 2017**

(51) **LOC (12) Cl.** ..... **14-03**

(52) **U.S. Cl.**  
USPC ..... **D14/188**

(58) **Field of Classification Search**  
USPC ..... D14/162, 167-169, 175, 179, 188,  
D14/194-198, 217, 257, 265, 299, 496  
CPC ..... B60R 11/0217; G06F 1/1688; G10K 9/22;  
G10K 11/004; H03F 1/327; H04M 1/03;  
H04M 1/035; H04N 5/642; H04N  
21/4852; H04R 1/02; H04R 1/06; H04R  
1/021; H04R 1/025; H04R 1/026; H04R  
1/028; H04R 1/105; H04R 1/323; H04R  
1/403; H04R 1/2803; H04R 1/2834;  
H04R 5/02; H04R 7/20; H04R 9/06;  
H04R 9/025; H04R 2201/021; H04R  
2400/00; H04R 2201/07; H04R 2499/11;  
H04R 2499/13; H04R 2499/15; H04S  
3/00; H04S 7/30

See application file for complete search history.

(56) **References Cited**

**U.S. PATENT DOCUMENTS**

D482,673 S \* 11/2003 Shindo ..... D14/188  
D500,488 S \* 1/2005 Uehara ..... D14/188

D500,489 S \* 1/2005 Uehara ..... D14/188  
D500,752 S \* 1/2005 Uehara ..... D14/188  
D656,120 S \* 3/2012 Sasaki ..... D14/188  
D665,377 S \* 8/2012 Endo ..... D14/188  
D694,735 S \* 12/2013 Wilson ..... D14/188  
D699,210 S \* 2/2014 Naito ..... D14/188  
D708,087 S \* 7/2014 Yu ..... D10/120  
D870,086 S \* 12/2019 Zhang ..... D14/243

\* cited by examiner

*Primary Examiner* — Keli L Hill

(74) *Attorney, Agent, or Firm* — Baker Botts LLP

(57) **CLAIM**

The ornamental design for a receiver, as shown and described.

**DESCRIPTION**

FIG. 1 is a perspective view of a receiver, according to an embodiment of my new design;  
FIG. 2 is a front view thereof;  
FIG. 3 is a rear view thereof;  
FIG. 4 is a left side view thereof;  
FIG. 5 is a right side view thereof;  
FIG. 6 is a top view thereof;  
FIG. 7 is a bottom view thereof; and,  
FIG. 8 is a perspective view thereof.

The dash-dot-dash broken lines immediately adjacent the shaded areas represent the bounds of the claimed design while all other broken lines are included for the purpose of illustrating portions of the Receiver; the broken lines form no part of the claimed design.

**1 Claim, 6 Drawing Sheets**

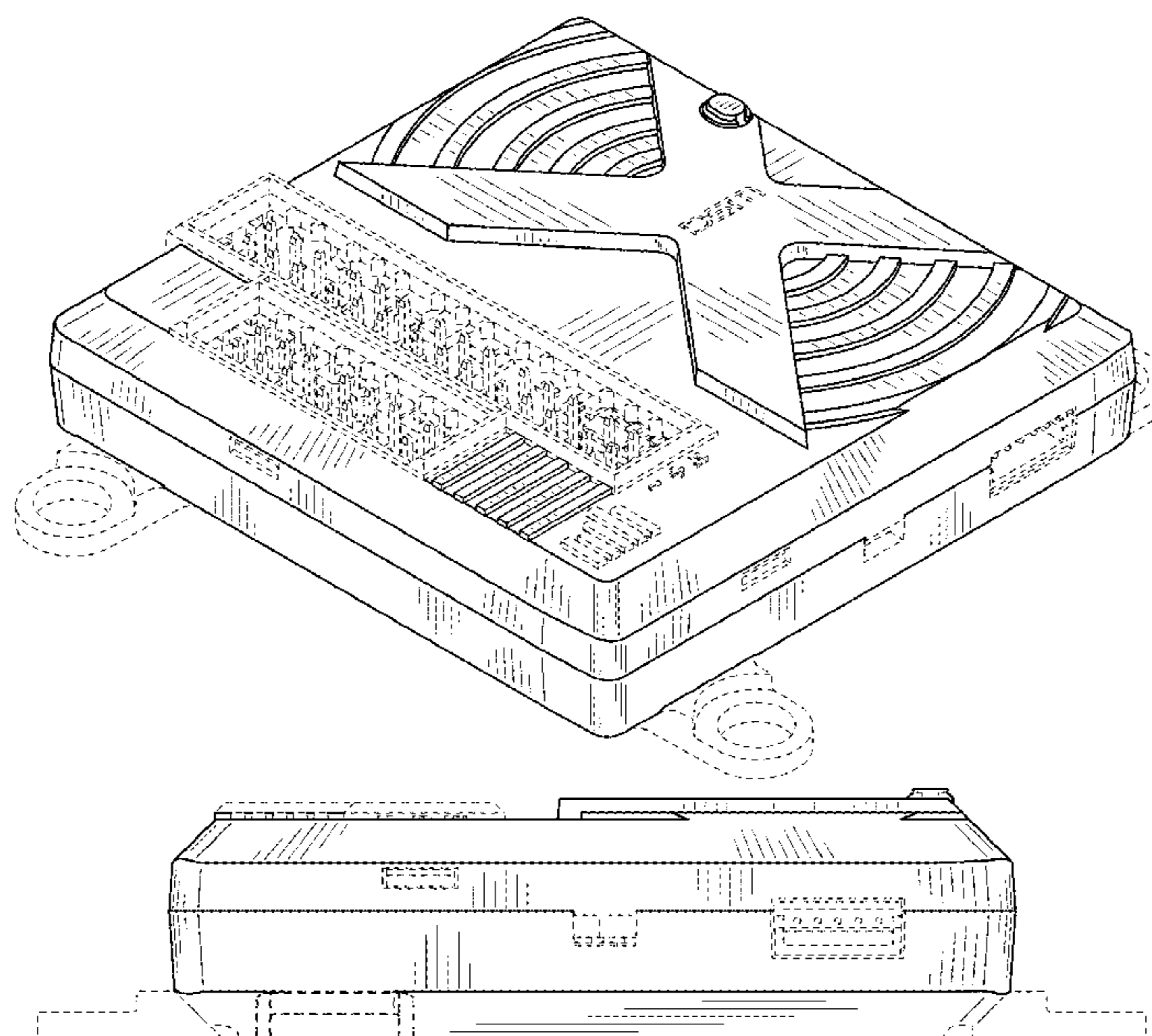

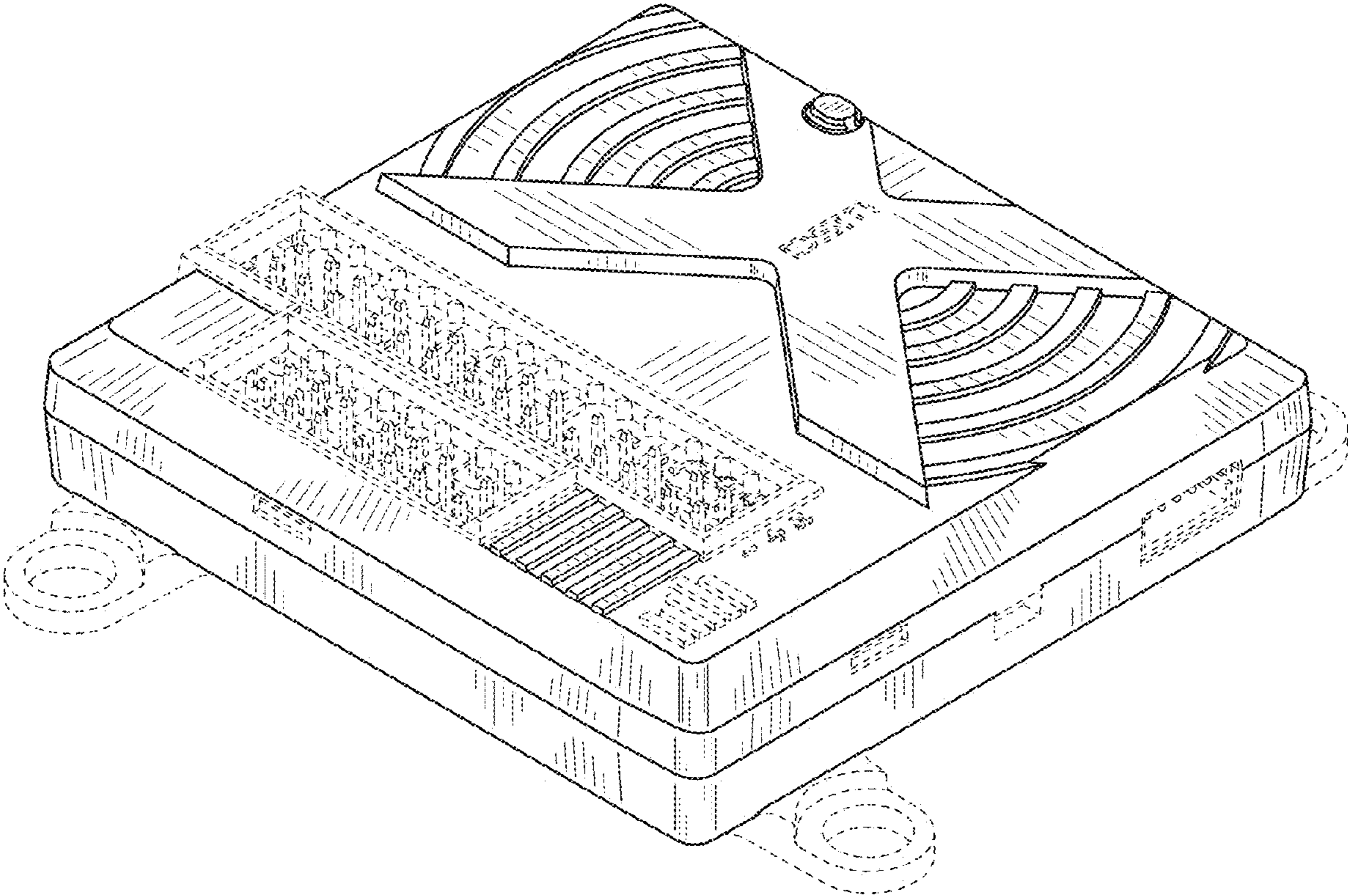

FIG. 1

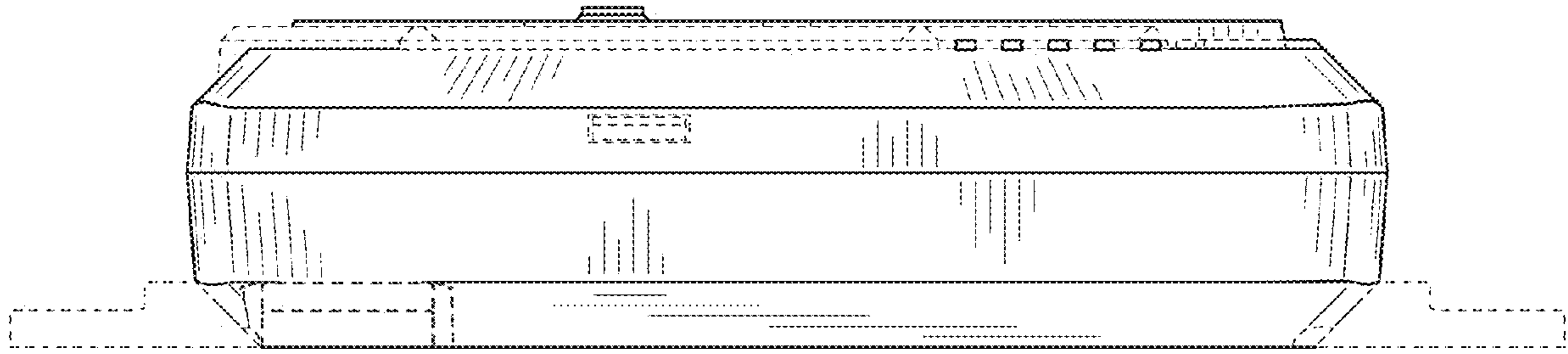

FIG. 2

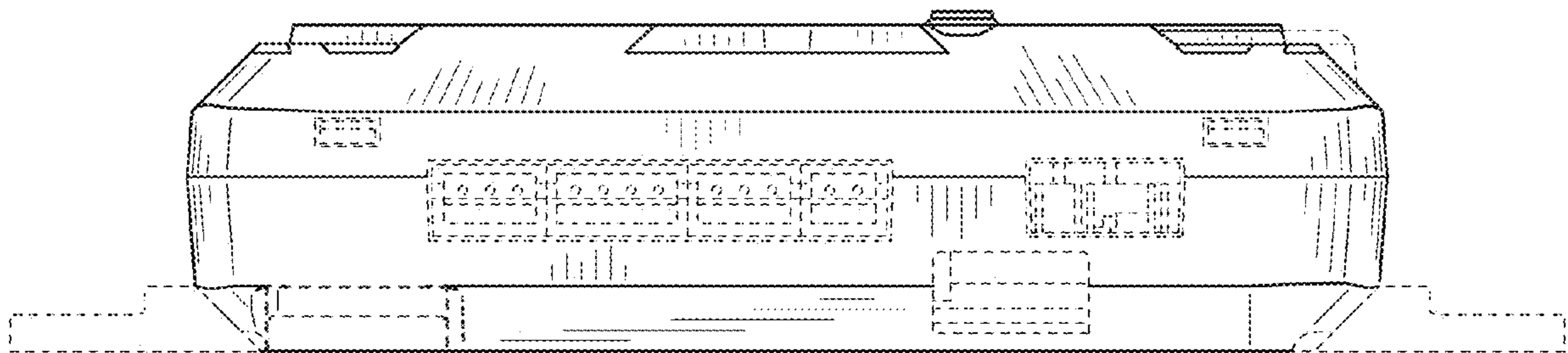

FIG. 3

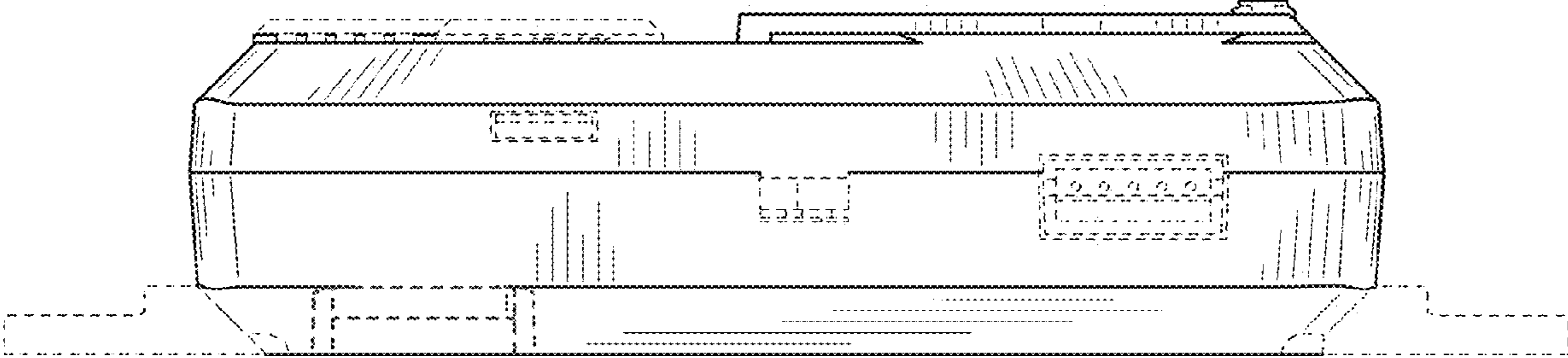

FIG. 4

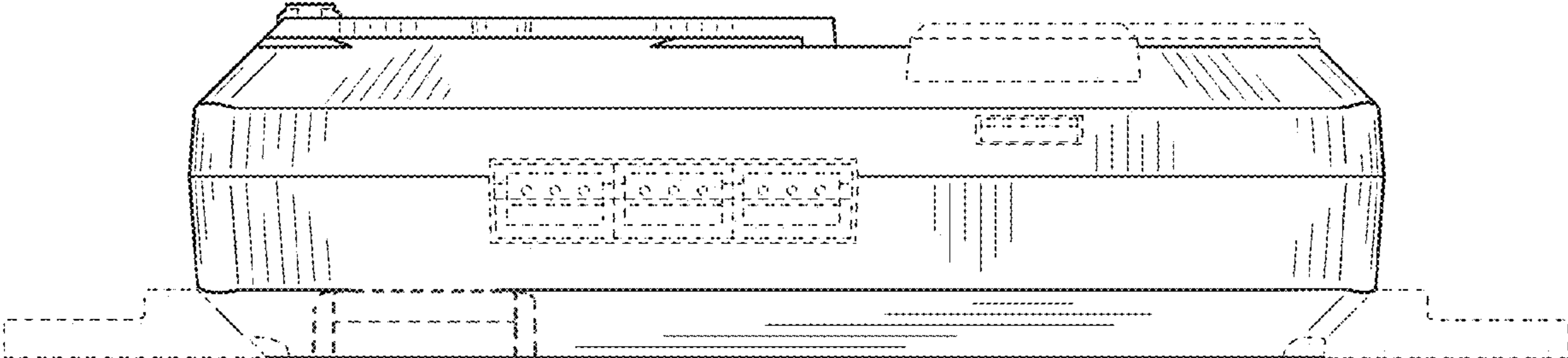

FIG. 5



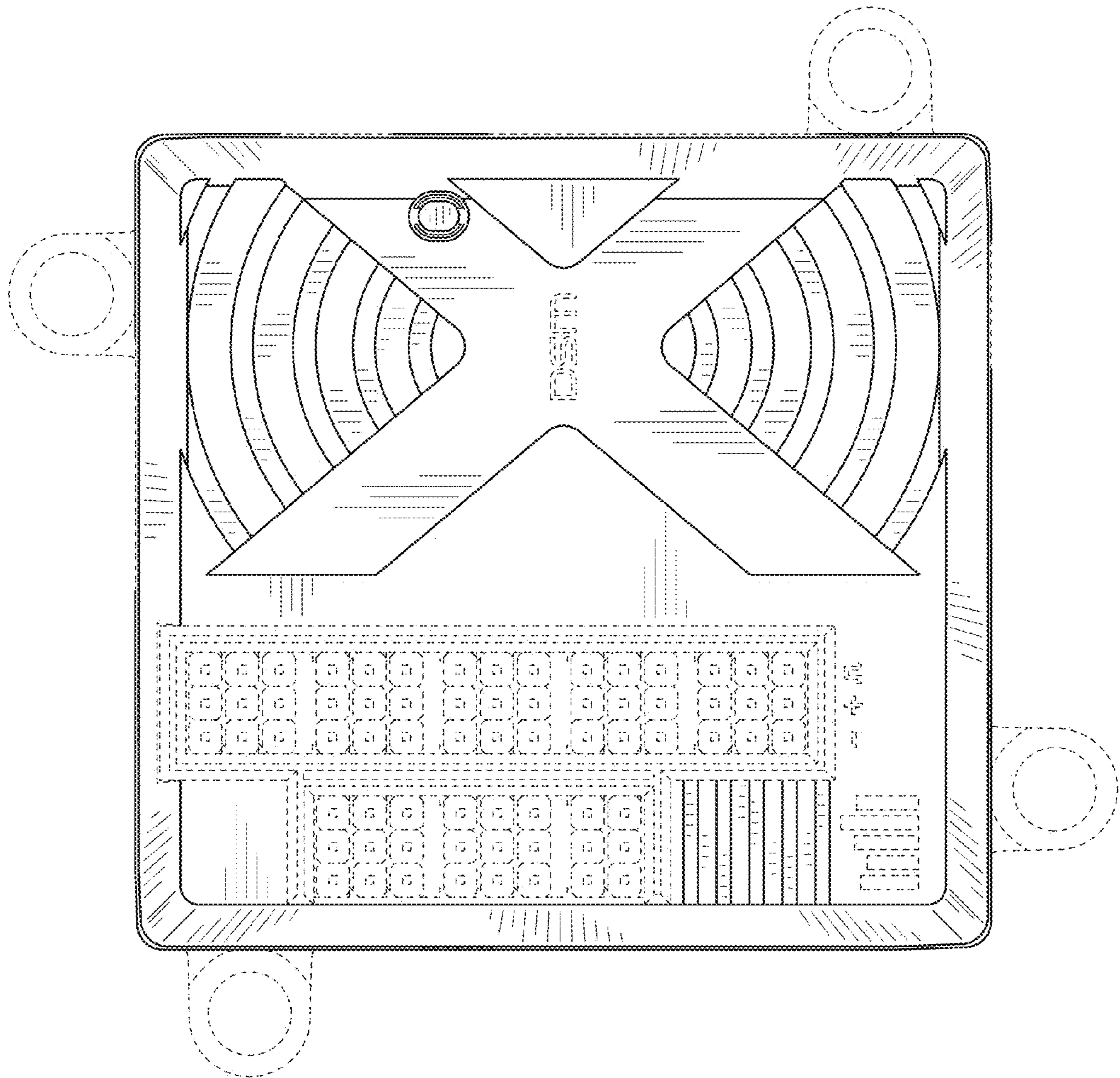

FIG. 6

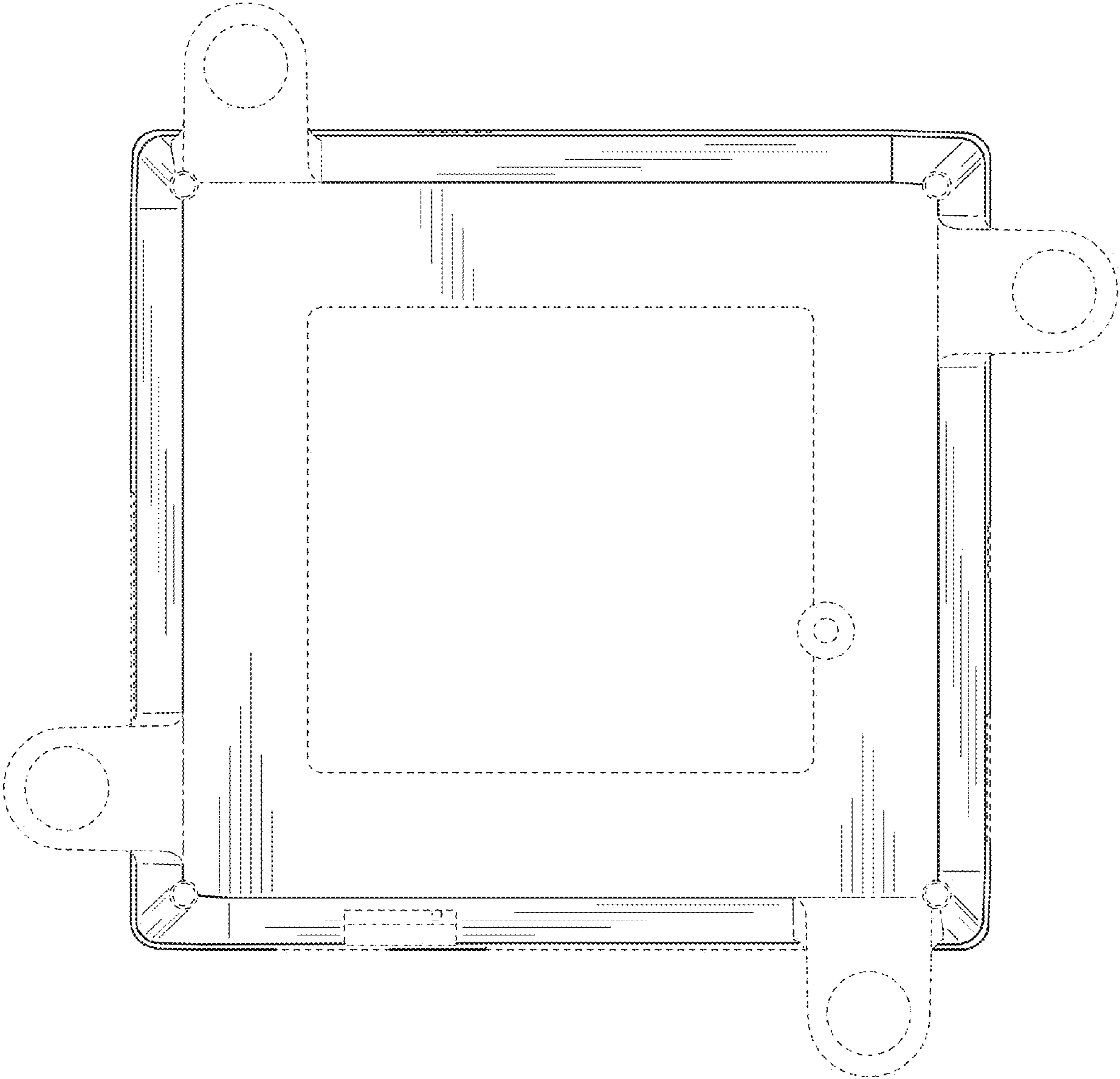

FIG. 7

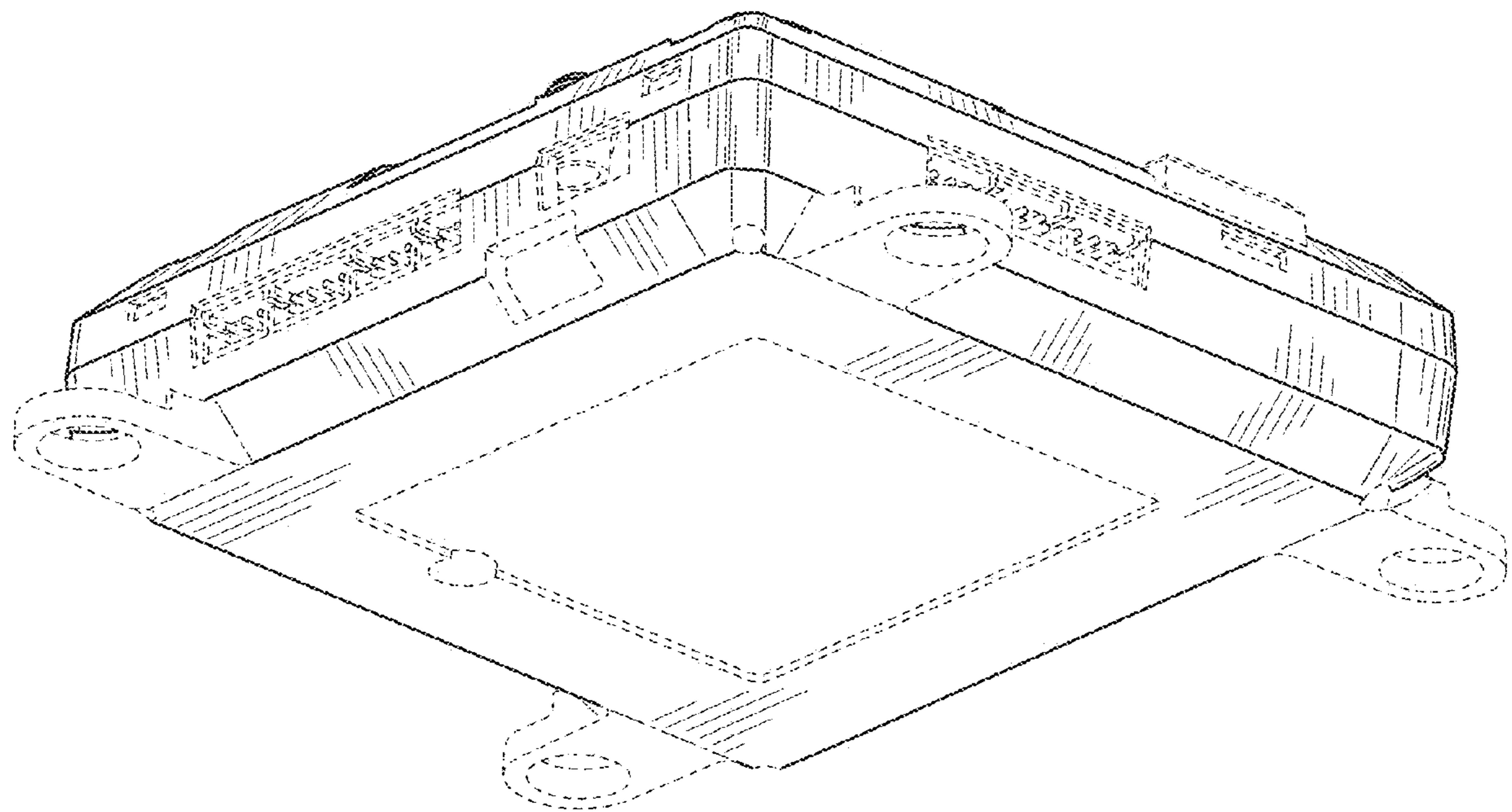

FIG. 8