



US00D886616S

(12) **United States Design Patent** (10) **Patent No.:** **US D886,616 S**
Van Skaik et al. (45) **Date of Patent:** **** Jun. 9, 2020**

(54) **BOTTLE**

(71) Applicant: **The Procter & Gamble Company**,
Cincinnati, OH (US)

(72) Inventors: **Elliott Michael Van Skaik**, Liberty
Township, OH (US); **Dennis Lee
Maclam**, Mason, OH (US); **Luis
Peraza**, New Albany, OH (US)

(73) Assignee: **The Procter & Gamble Company**,
Cincinnati, OH (US)

(**) Term: **15 Years**

(21) Appl. No.: **29/720,396**

(22) Filed: **Jan. 13, 2020**

(51) **LOC (12) Cl.** **09-01**

(52) **U.S. Cl.**
USPC **D9/516; D9/571**

(58) **Field of Classification Search**
USPC D9/434, 516, 530, 542, 549, 558,
D9/562-563, 566, 571, 574, 715, 719
(Continued)

(56) **References Cited**

U.S. PATENT DOCUMENTS

D30,758 S * 5/1899 Wipf D9/546
D222,433 S * 10/1971 Donoghue D9/542
(Continued)

FOREIGN PATENT DOCUMENTS

KR 20090118716 A 11/2009

OTHER PUBLICATIONS

U.S. Appl. No. 29/720,389, filed Jan. 13, 2020, Van Skaik et al.
(Continued)

Primary Examiner — Dana Meyrow

(74) *Attorney, Agent, or Firm* — Amanda Herman
Berghauer

(57) **CLAIM**

The ornamental design for a bottle, as shown and described.

DESCRIPTION

FIG. 1 is a perspective view of a first embodiment of a bottle;
FIG. 2 is a front view thereof;
FIG. 3 is a right side view thereof;
FIG. 4 is a rear view thereof;
FIG. 5 is a left side view thereof;
FIG. 6 is a top view thereof;
FIG. 7 is a bottom view thereof;
FIG. 8 is a perspective view of a second embodiment of a bottle;
FIG. 9 is a front view thereof;
FIG. 10 is a right side view thereof;
FIG. 11 is a rear view thereof;
FIG. 12 is a left side view thereof;
FIG. 13 is a top view thereof;
FIG. 14 is a bottom view thereof;
FIG. 15 is a perspective view of a third embodiment of a bottle;
FIG. 16 is a front view thereof;
FIG. 17 is a right side view thereof;
FIG. 18 is a rear view thereof;
FIG. 19 is a left side view thereof;
FIG. 20 is a top view thereof;
FIG. 21 is a bottom view thereof;
FIG. 22 is a perspective view of a fourth embodiment of a bottle;
FIG. 23 is a front view thereof;
FIG. 24 is a right side view thereof;
FIG. 25 is a rear view thereof;
FIG. 26 is a left side view thereof;
FIG. 27 is a top view thereof; and,
FIG. 28 is a bottom view thereof.
The broken lines in the drawings illustrate the portions of the bottle that form no part of the claimed design.

1 Claim, 12 Drawing Sheets

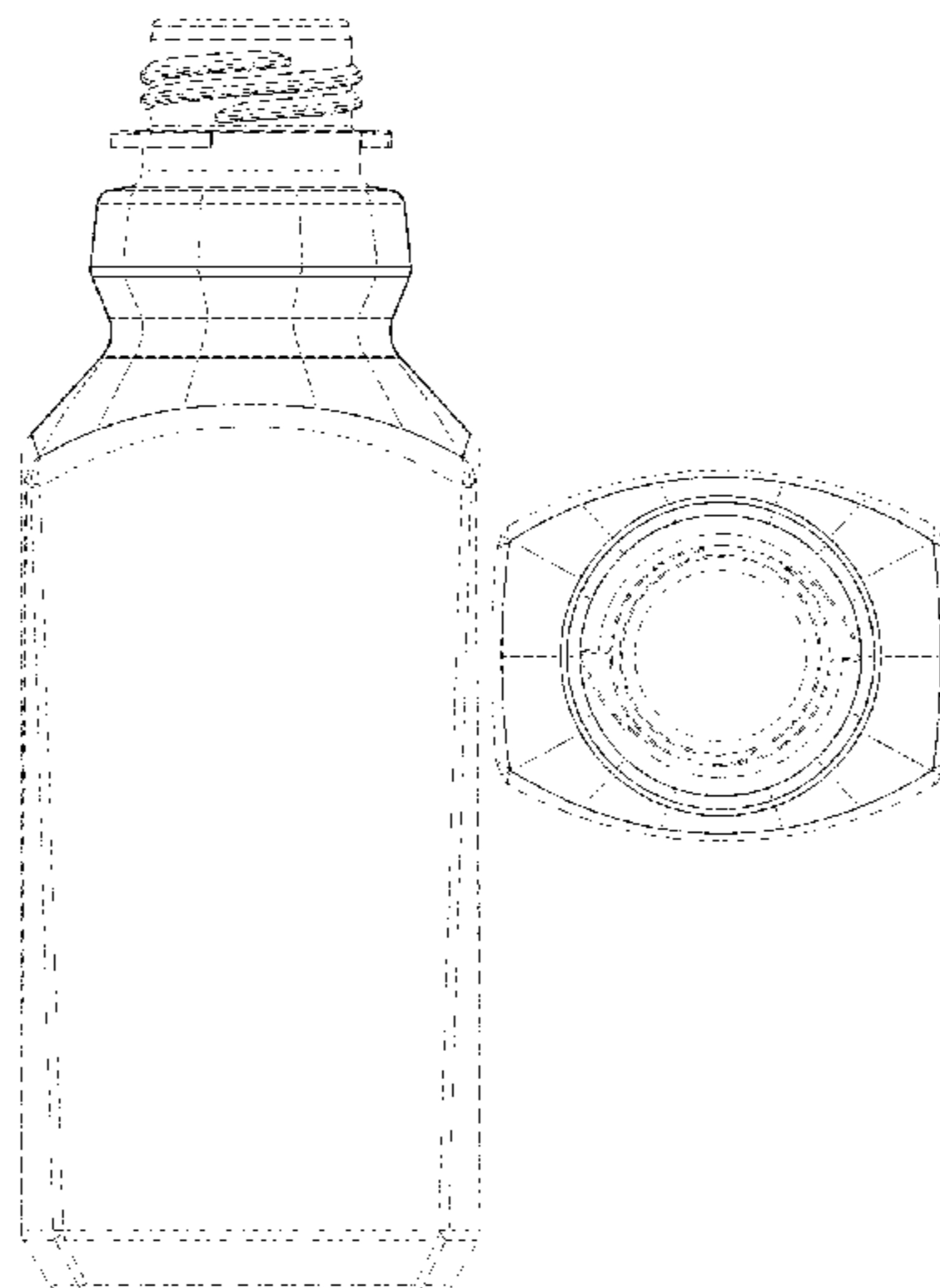

(58) **Field of Classification Search**

CPC B65D 1/00; B65D 1/02; B65D 1/0223;
B65D 23/00; B65D 51/32; B65D
2501/00; B65D 2501/0009; B65D
2501/0081

See application file for complete search history.

(56) **References Cited**

U.S. PATENT DOCUMENTS

D263,025	S	*	2/1982	Schoeneck	D9/542
D278,118	S	*	3/1985	Hoyt	D9/436
D472,472	S	*	4/2003	Meeker	D9/563
D577,593	S	*	9/2008	Hestehave	D9/452
D578,007	S	*	10/2008	Hestehave	D9/453
D578,399	S	*	10/2008	Hestehave	D9/452
D579,338	S	*	10/2008	Hestehave	D9/452
D600,565	S	*	9/2009	Kuzma	D9/563
D674,284	S	*	1/2013	Harris	D9/520
D676,329	S	*	2/2013	Yourist	D9/541
D759,492	S	*	6/2016	Dominick	D9/542
D770,902	S	*	11/2016	Vaughn-Batiz	D9/560
D782,911	S	*	4/2017	Dominick	D9/542
D831,494	S	*	10/2018	Smith	D9/560

OTHER PUBLICATIONS

U.S. Appl. No. 29/720,354, filed Jan. 13, 2020, Van Skaik et al.

U.S. Appl. No. 29/720,397, filed Jan. 13, 2020, Van Skaik et al.

U.S. Appl. No. 62/960,170, filed Jan. 13, 2020, Van Skaik et al.

* cited by examiner

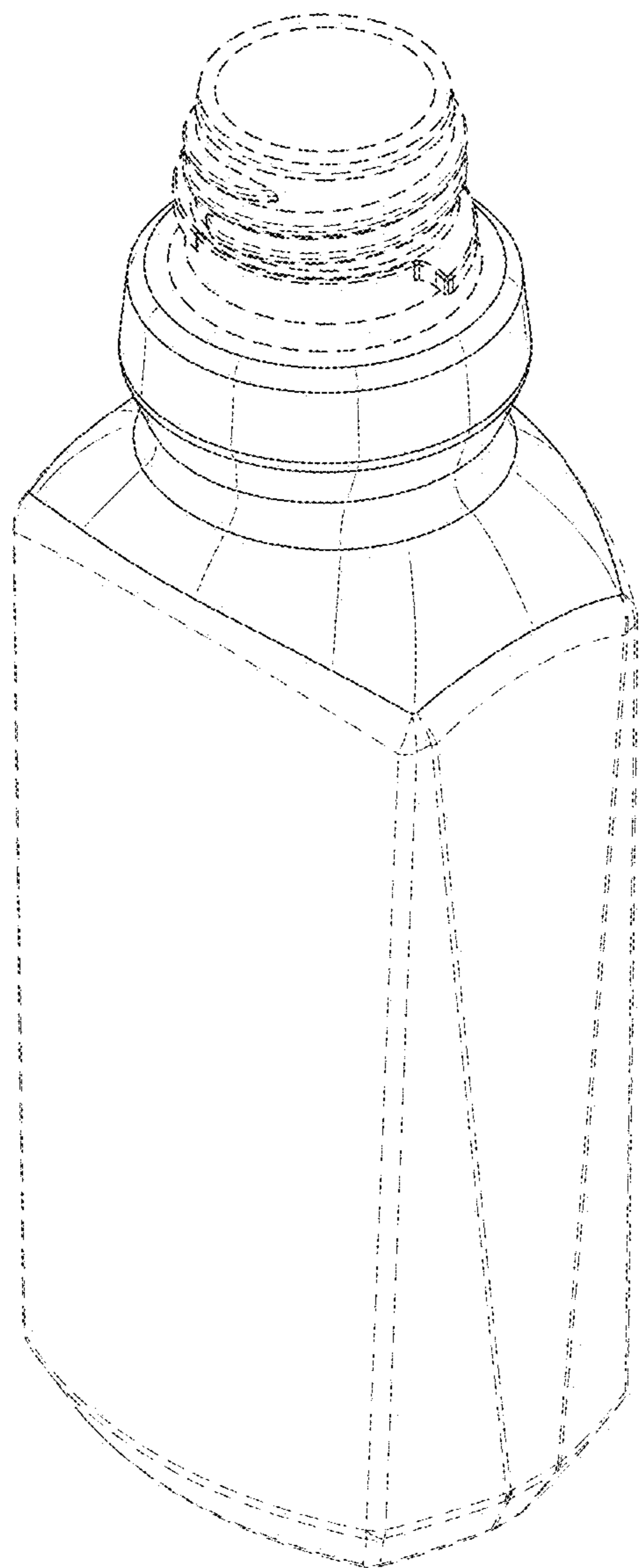

FIG. 1

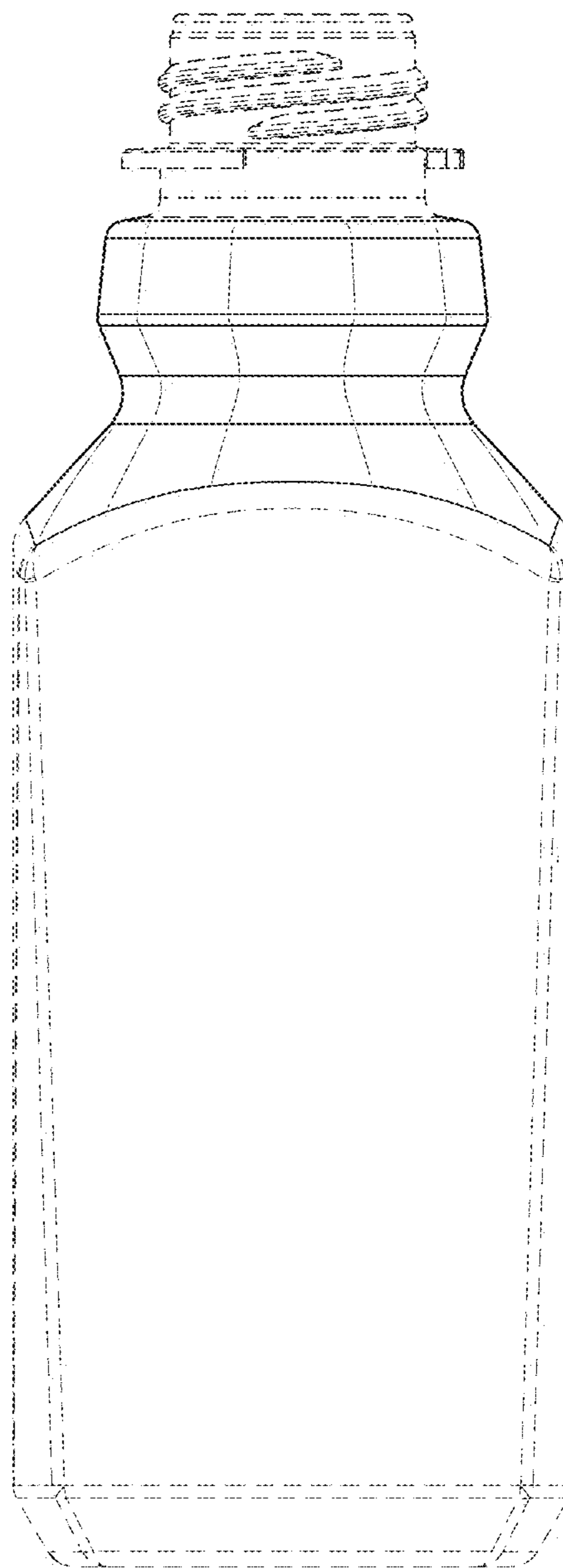

FIG. 2

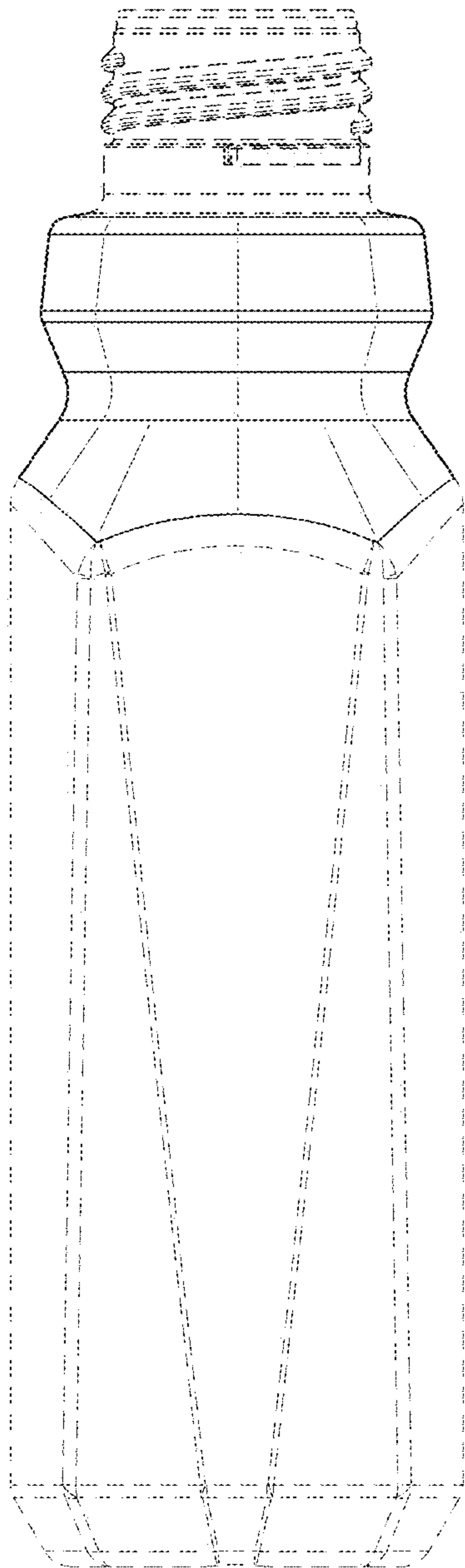

FIG. 3

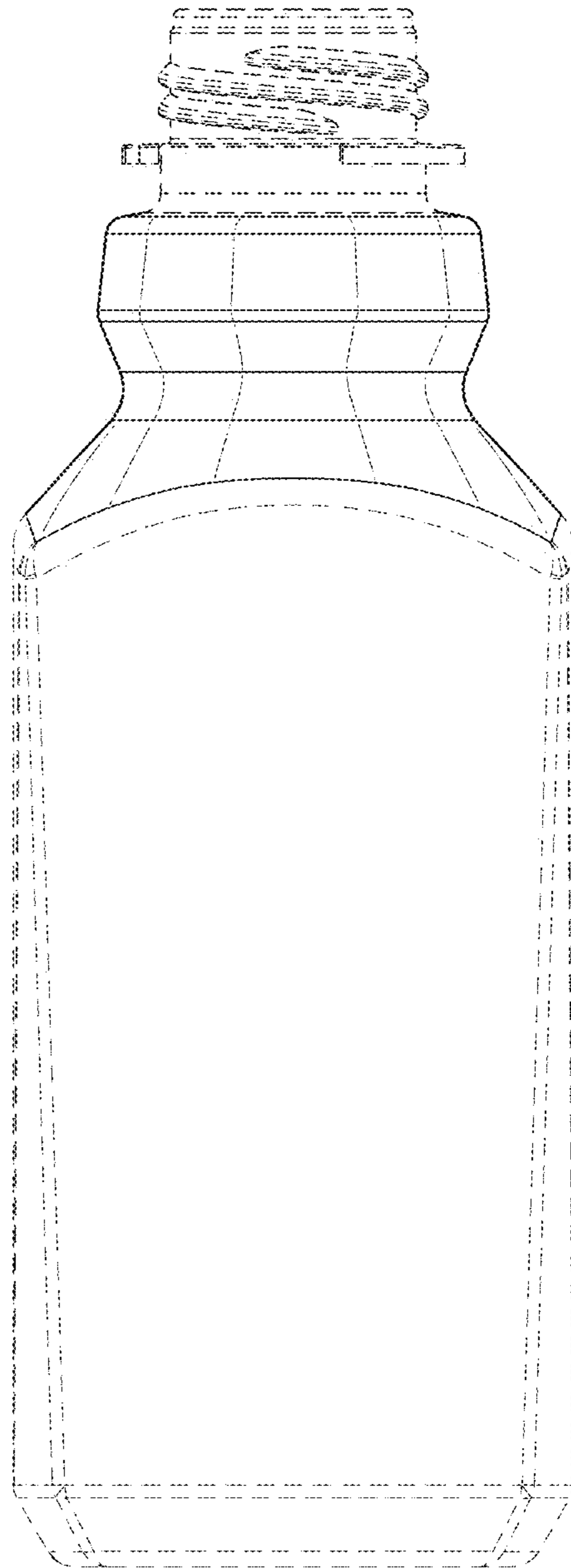

FIG. 4

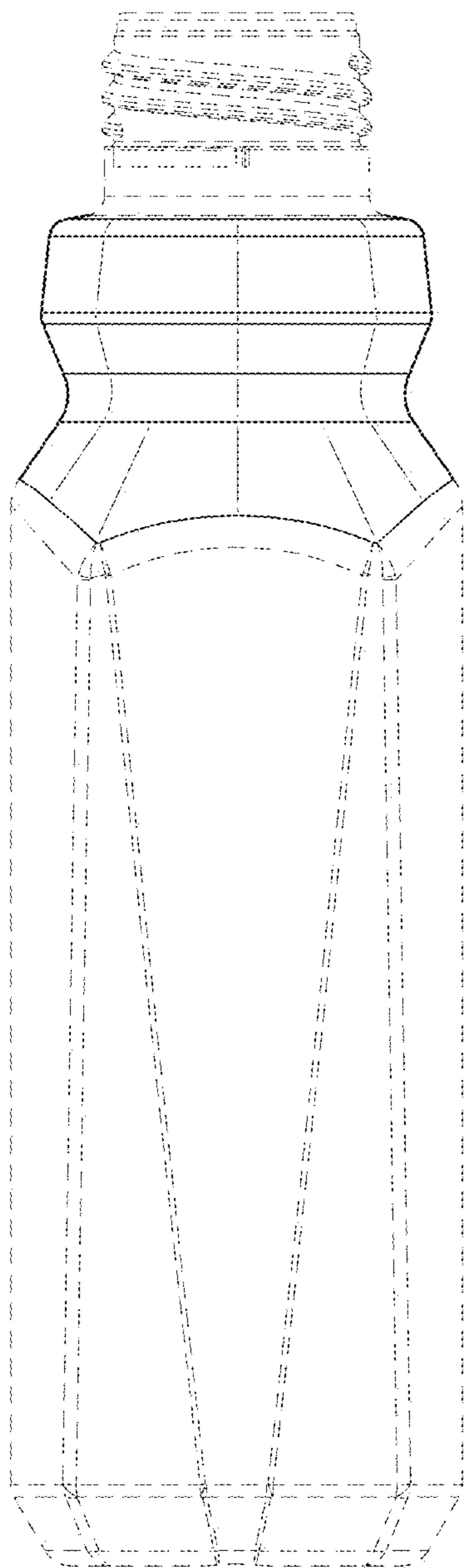

FIG. 5

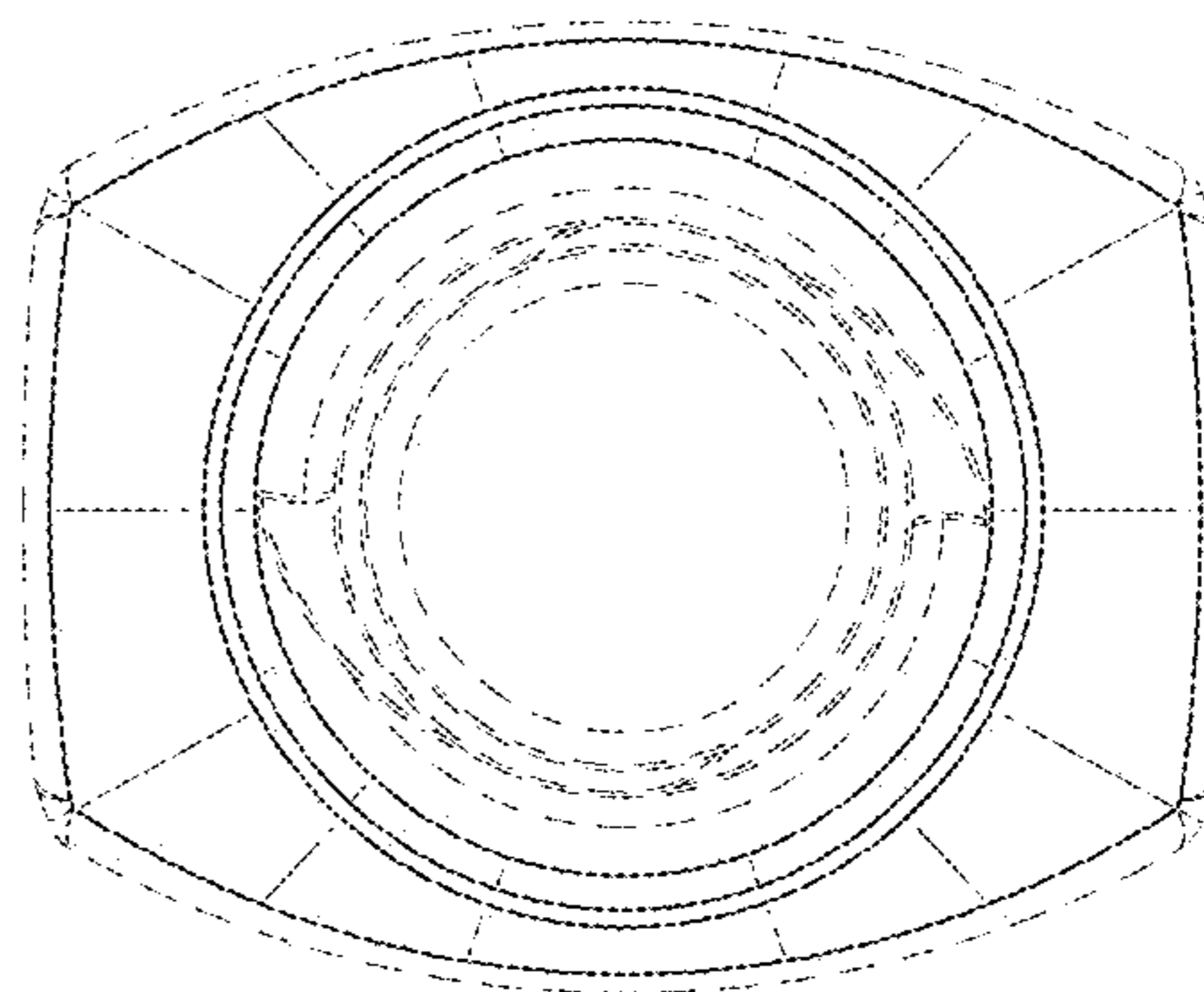

FIG. 6

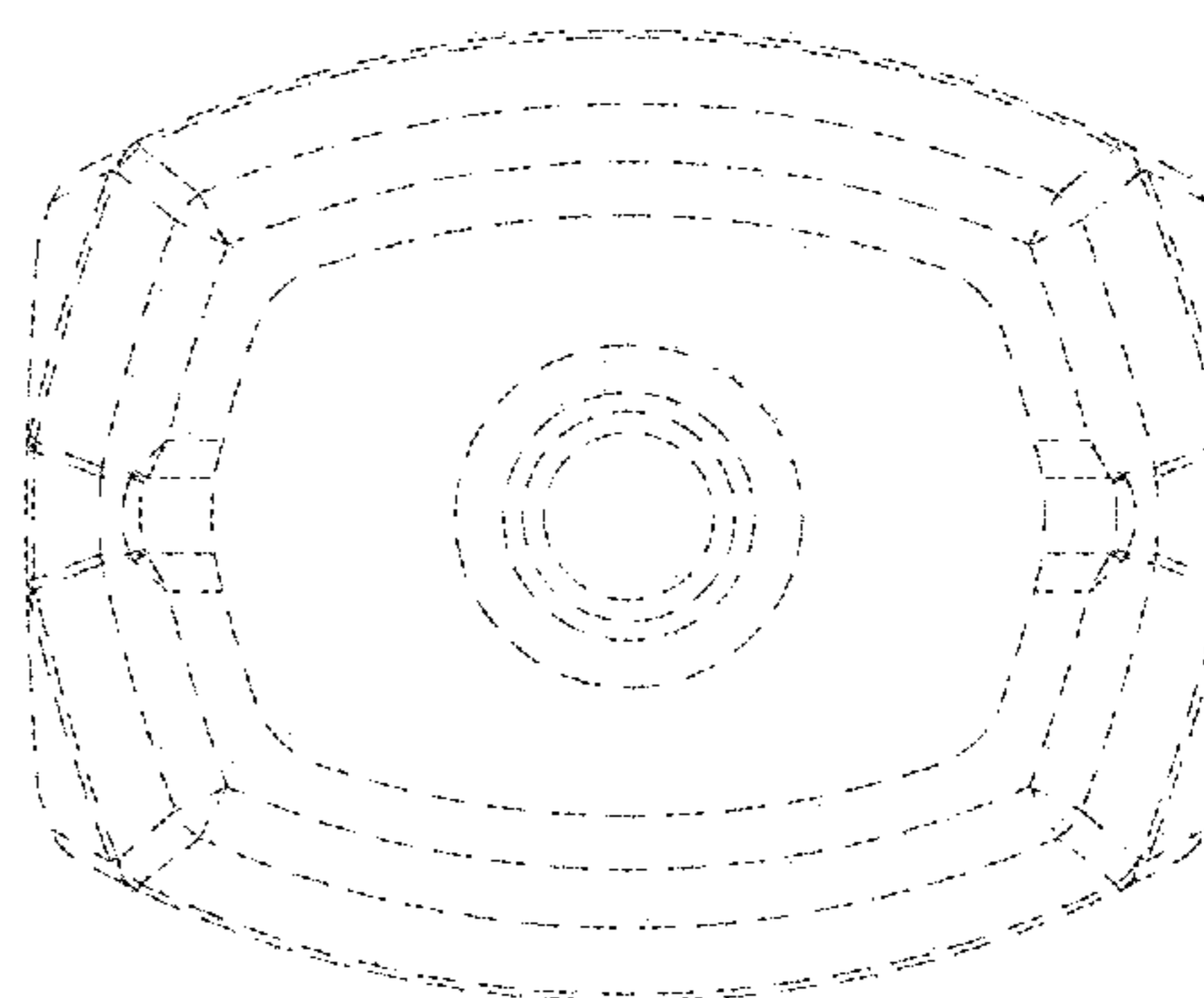

FIG. 7

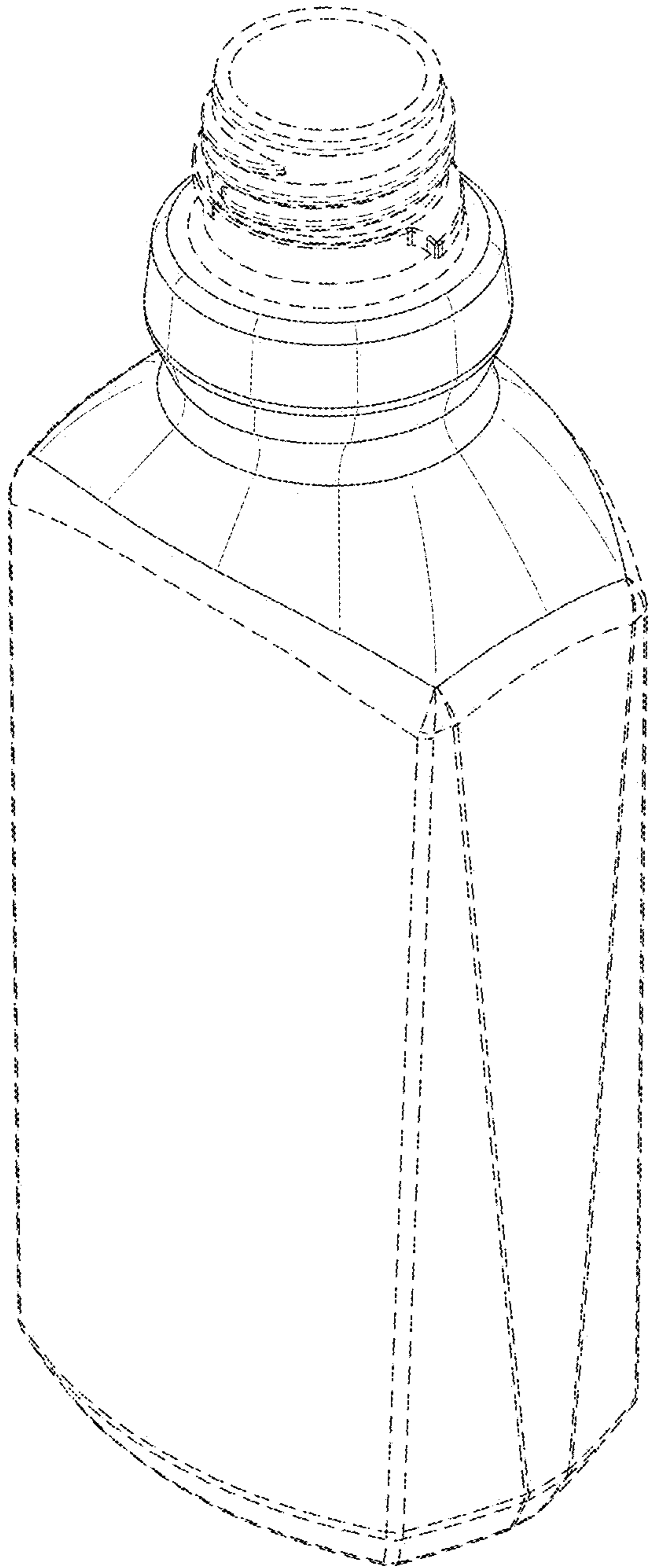

FIG. 8

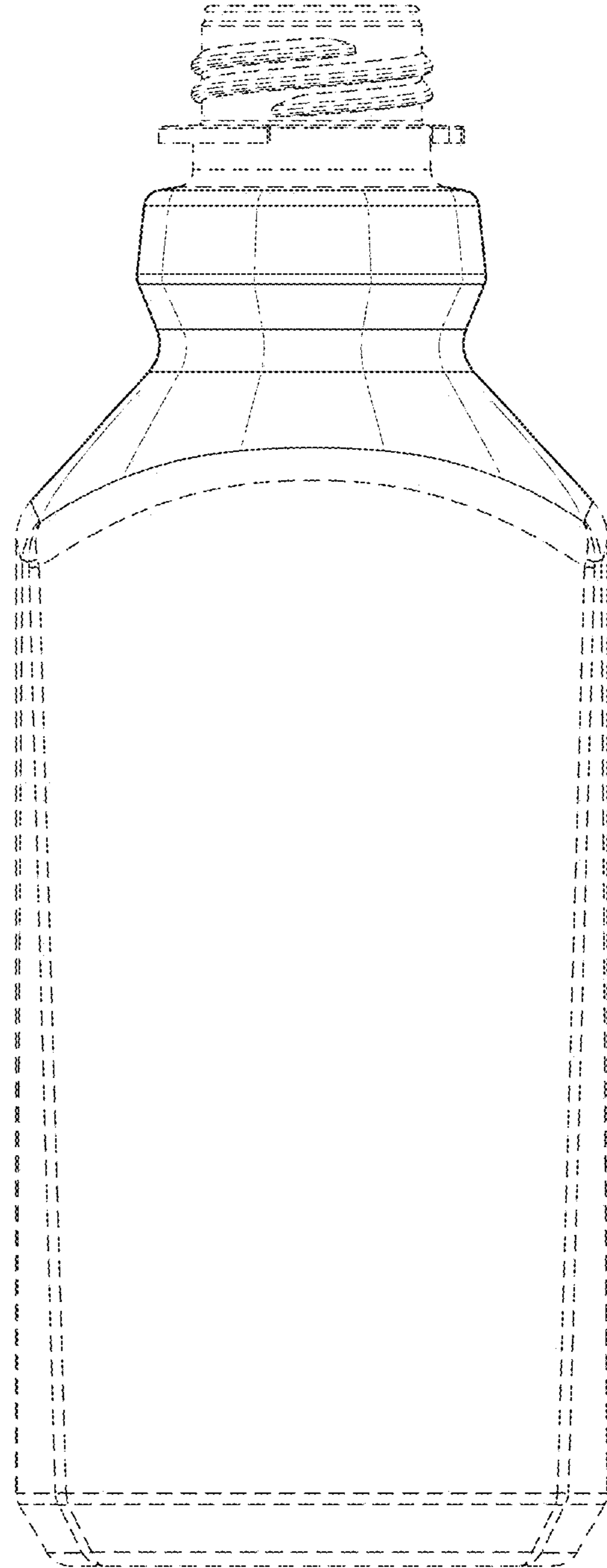

FIG. 9

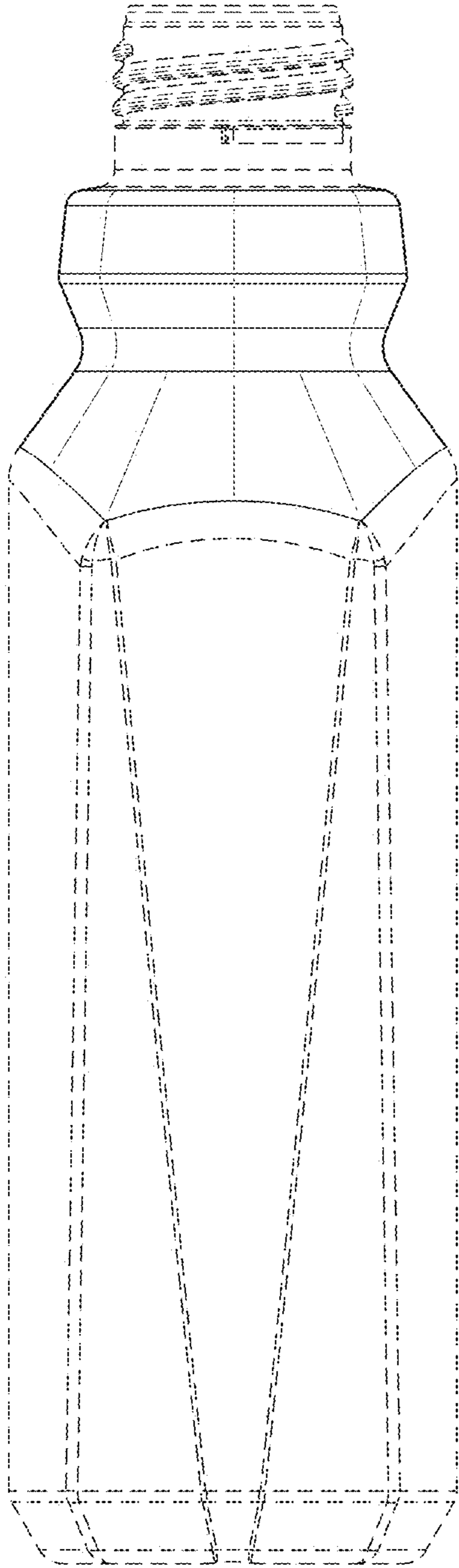

FIG. 10

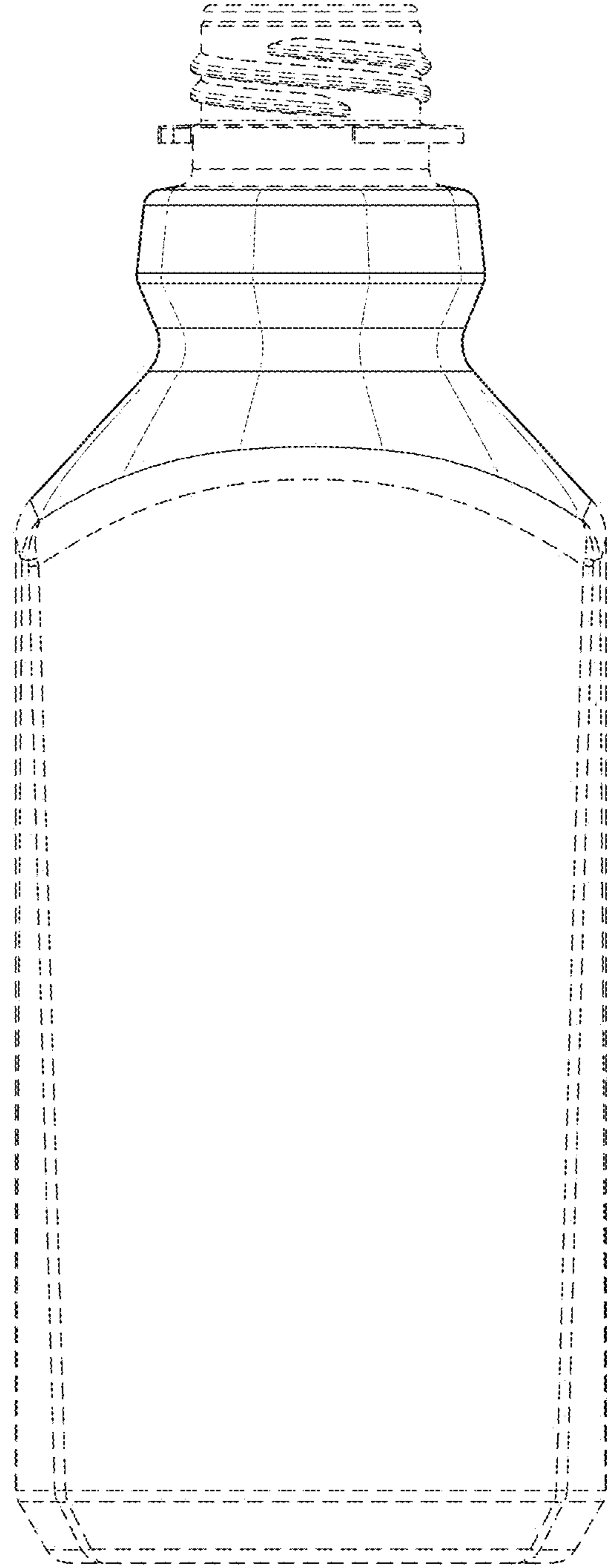

FIG. 11

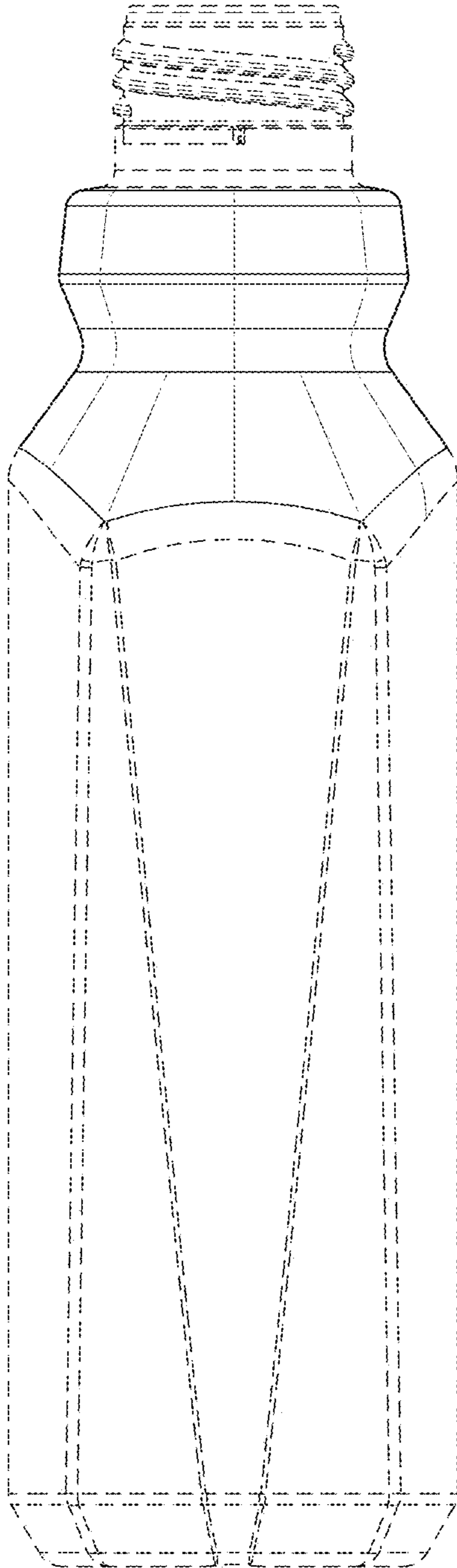

FIG. 12

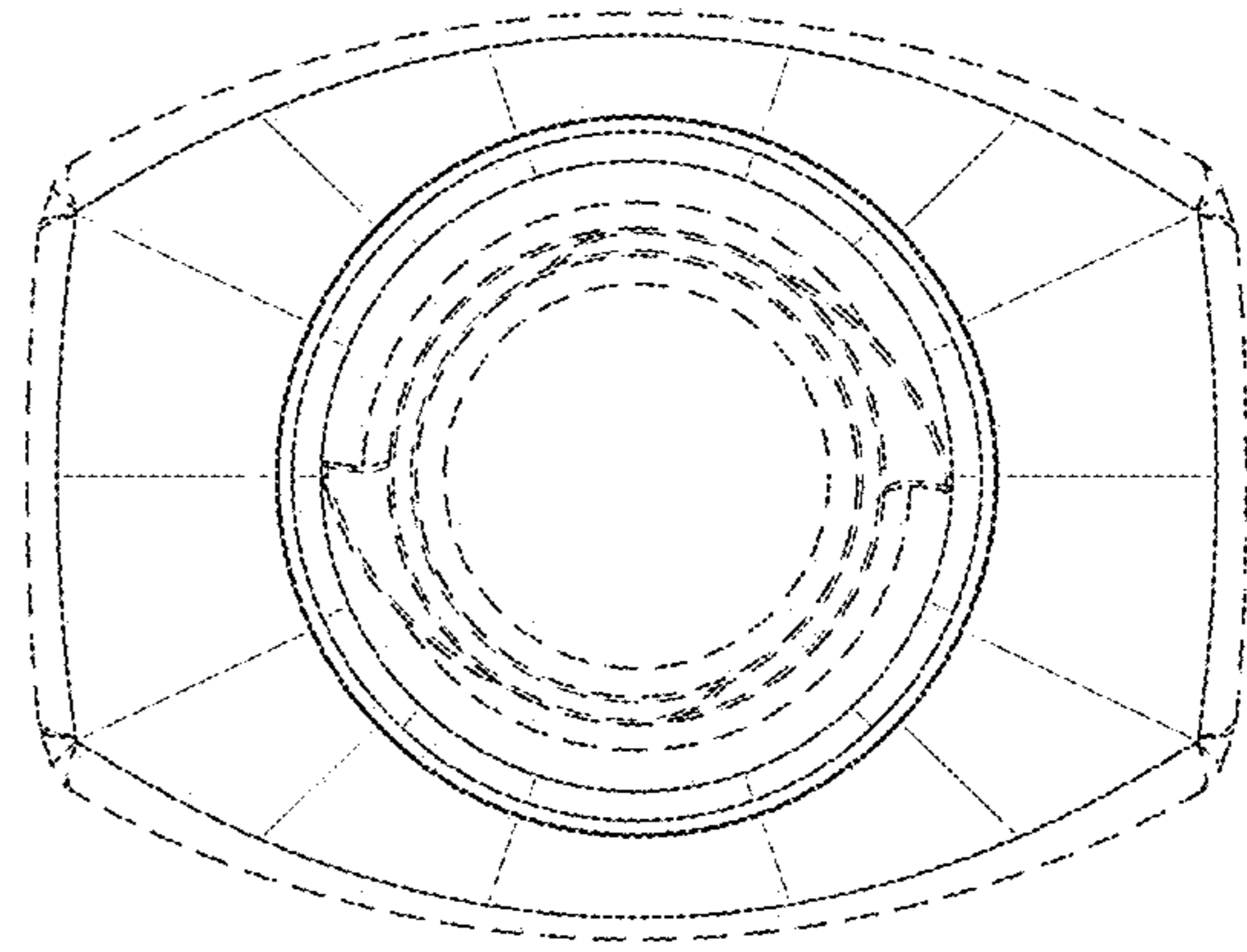

FIG. 13

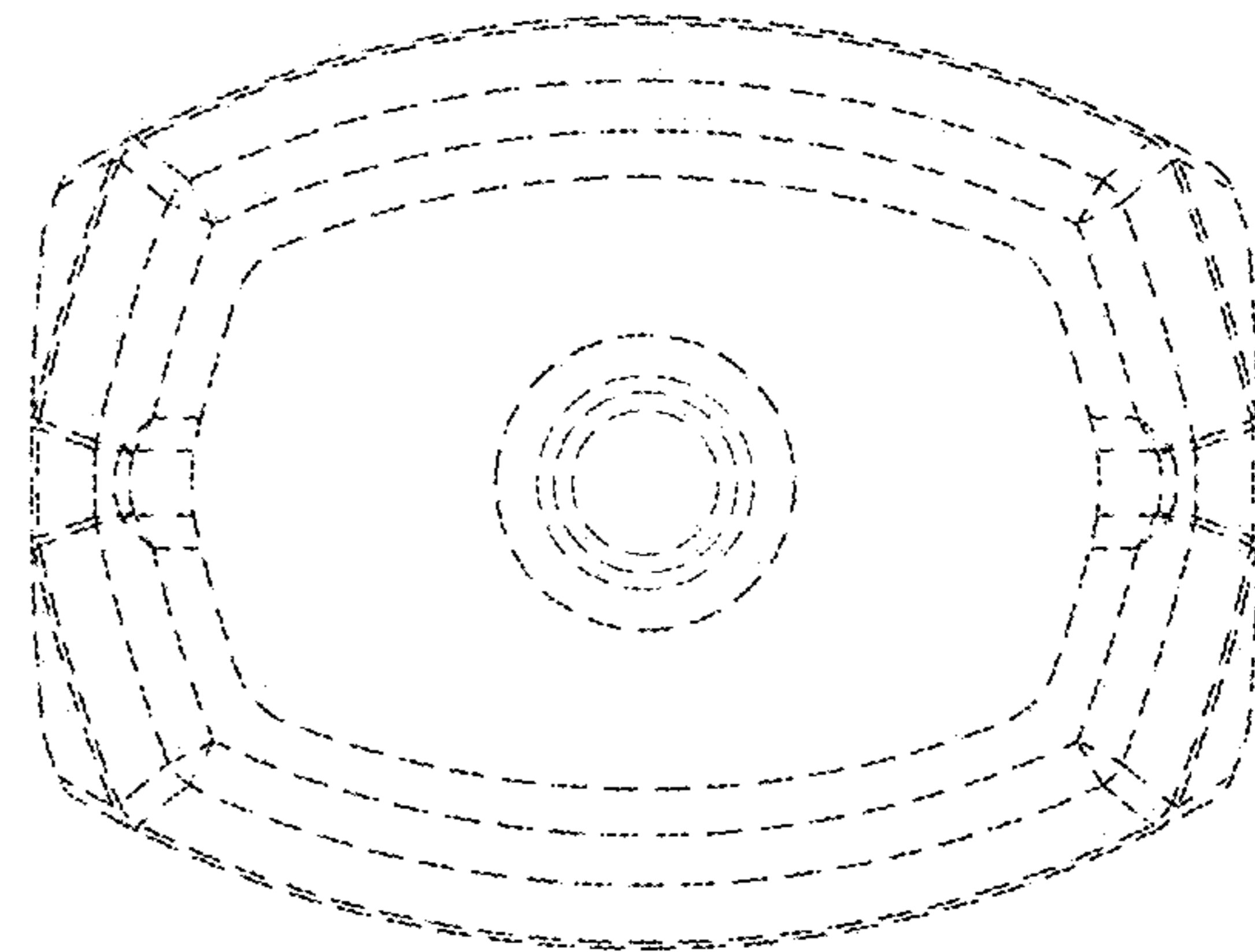

FIG. 14

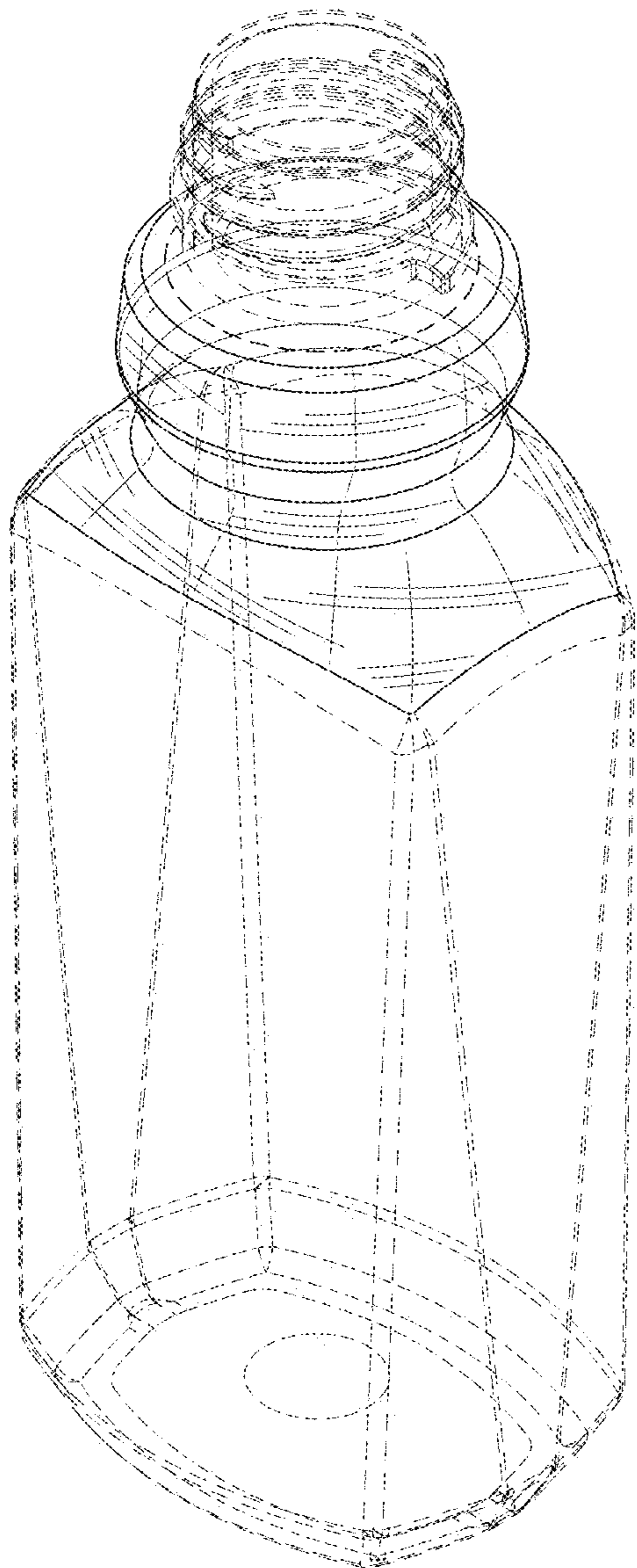

FIG. 15

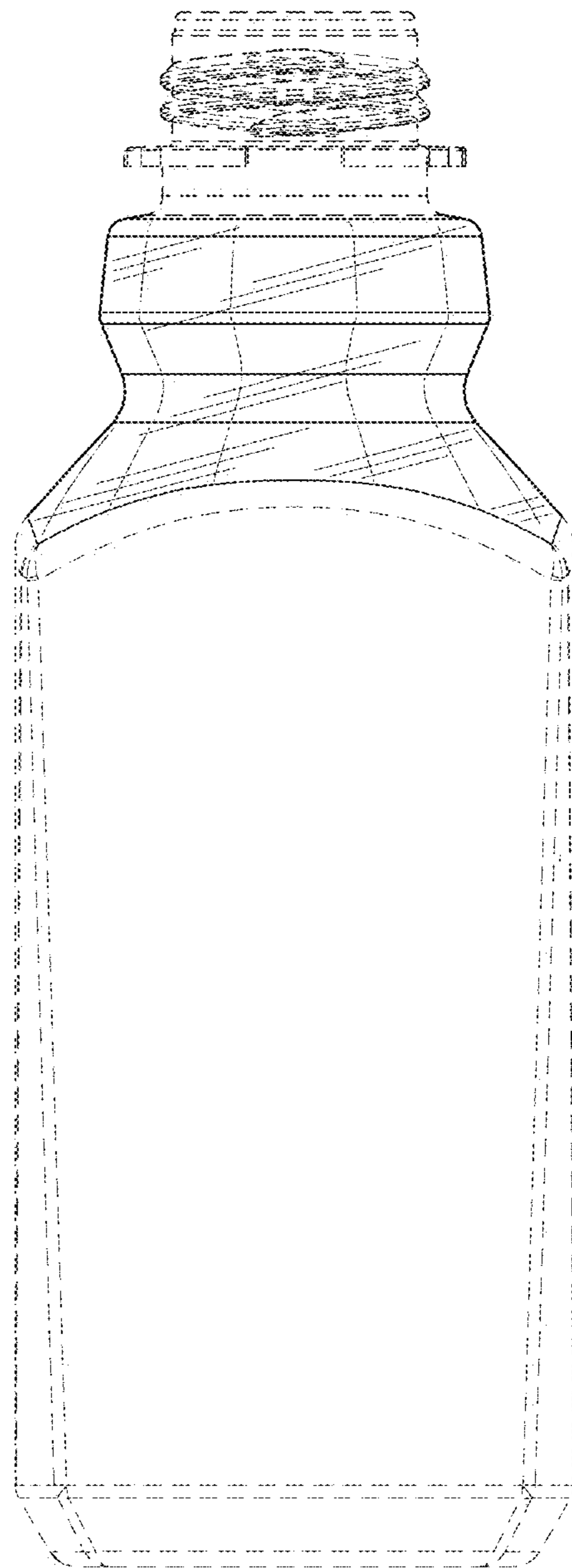

FIG. 16

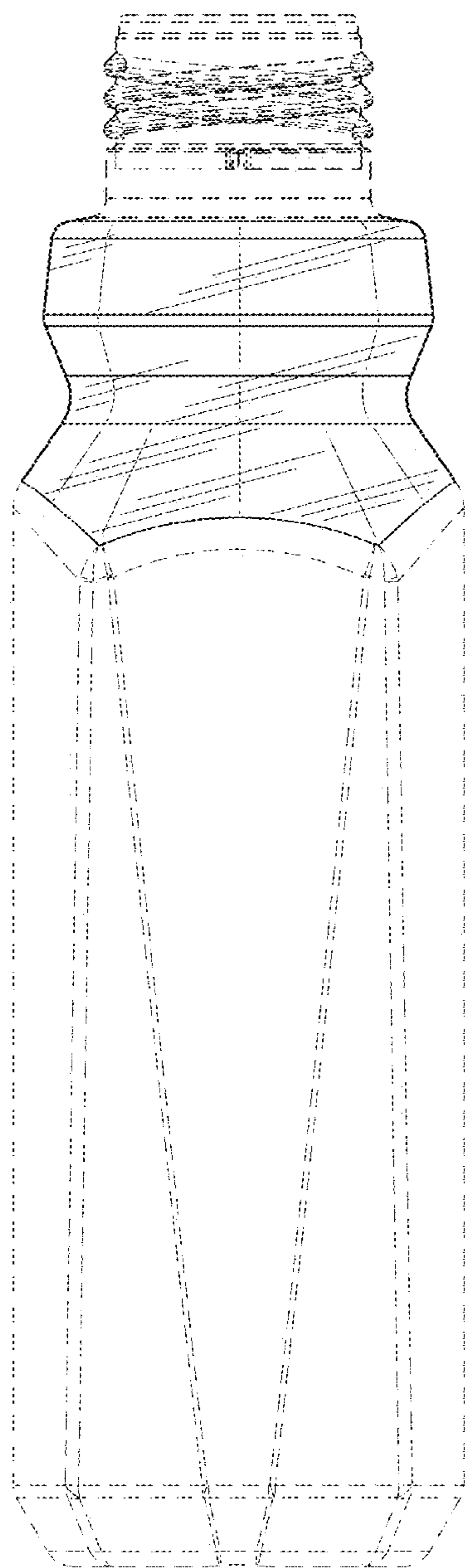

FIG. 17

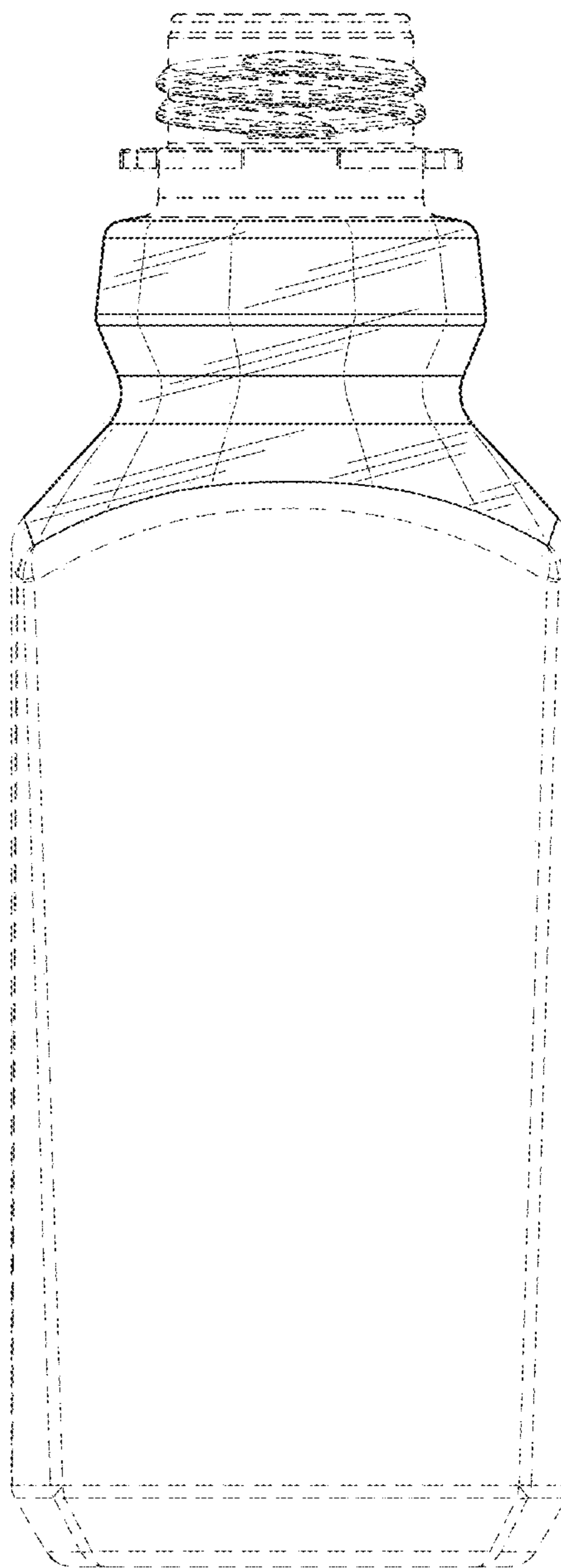

FIG. 18

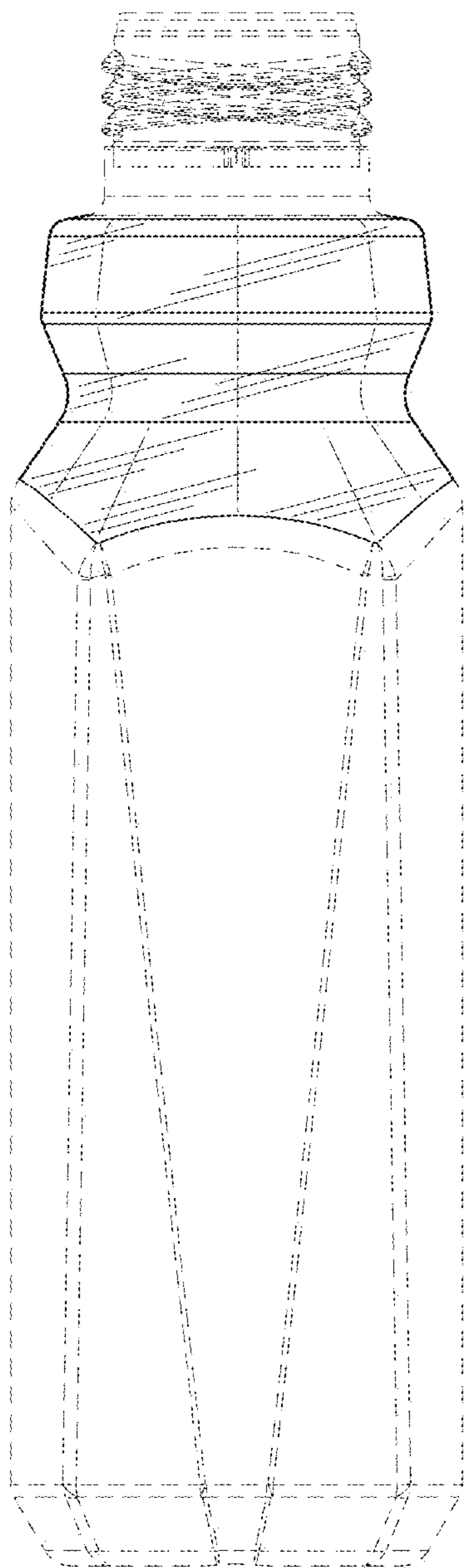

FIG. 19

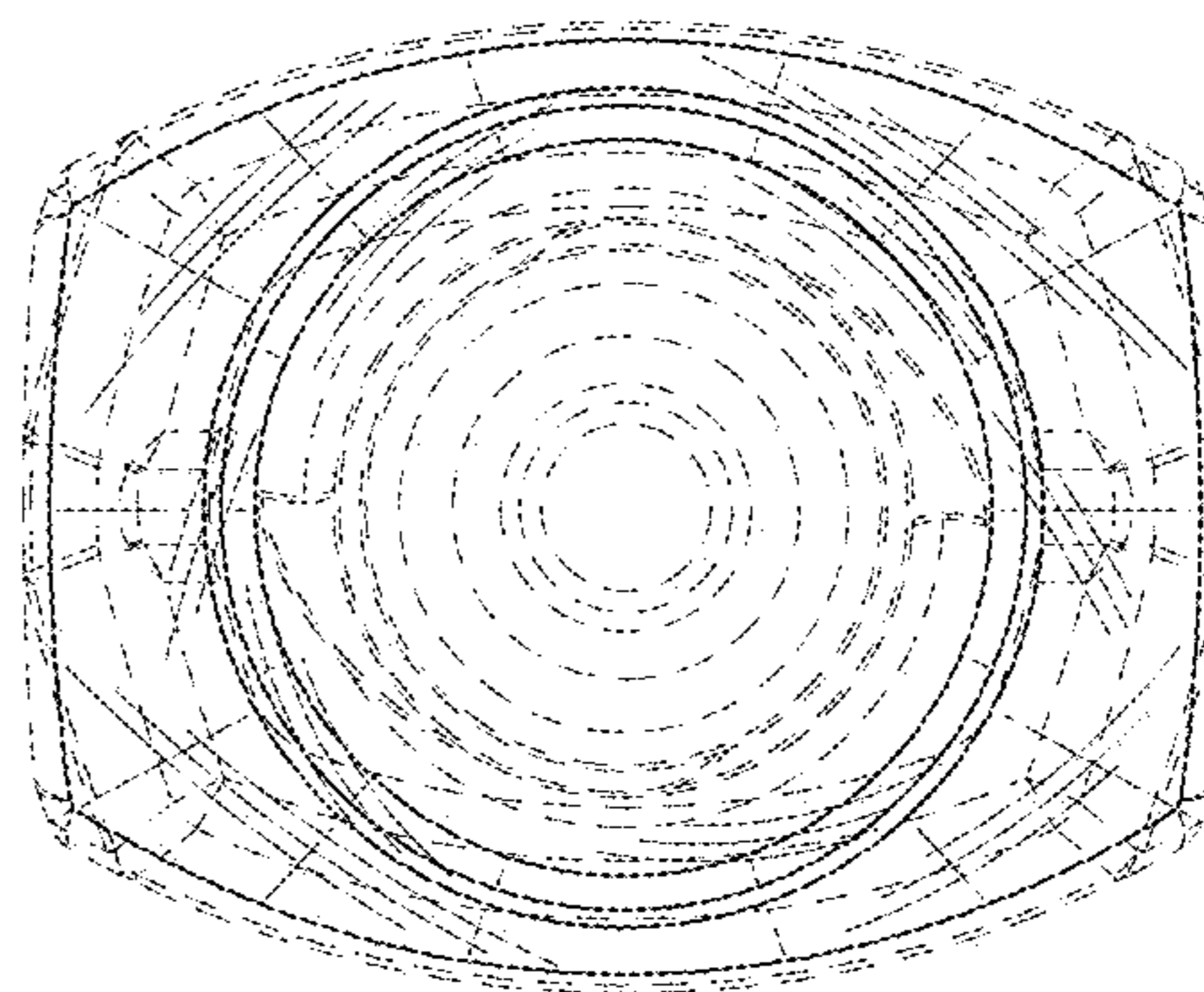

FIG. 20

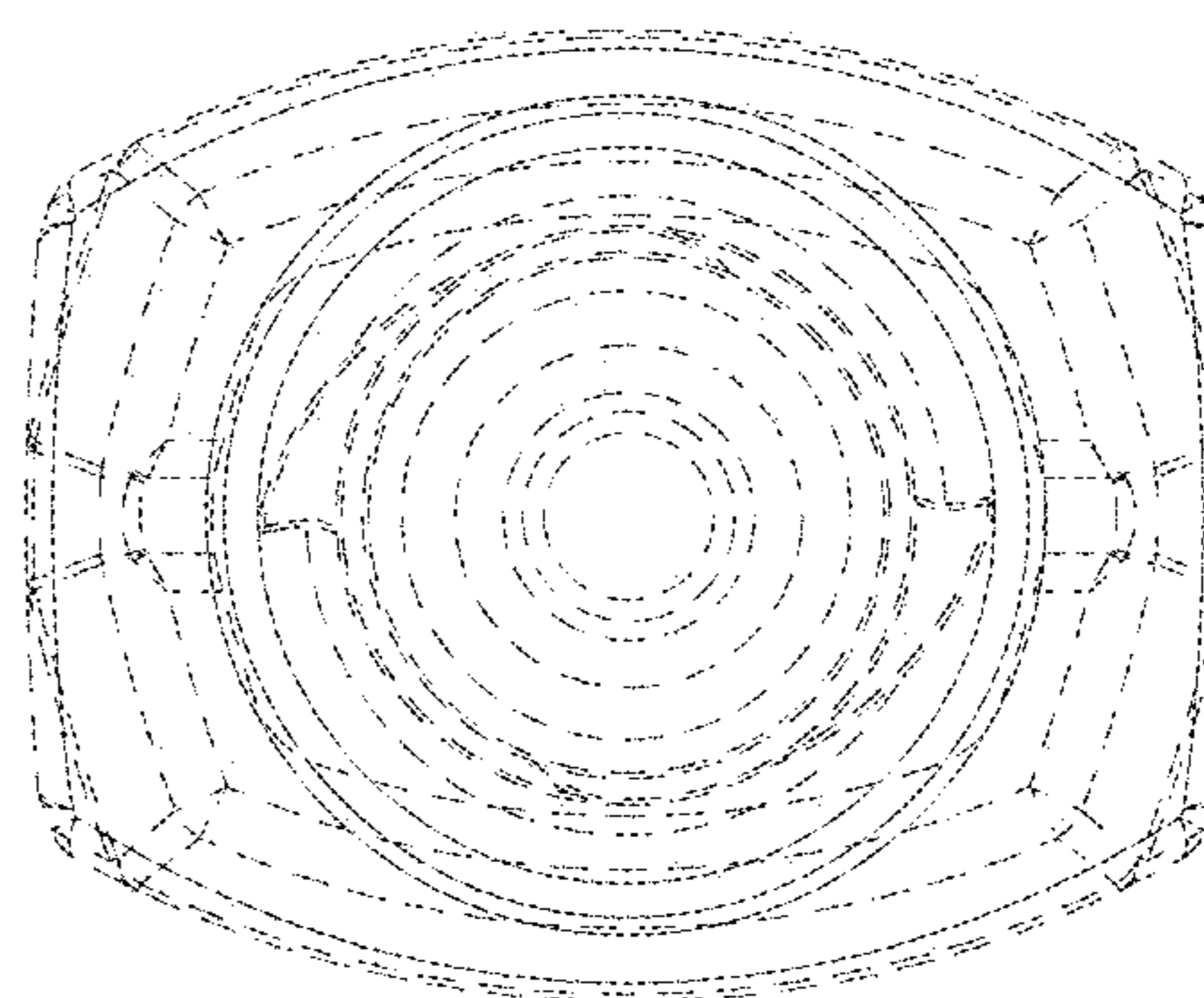

FIG. 21

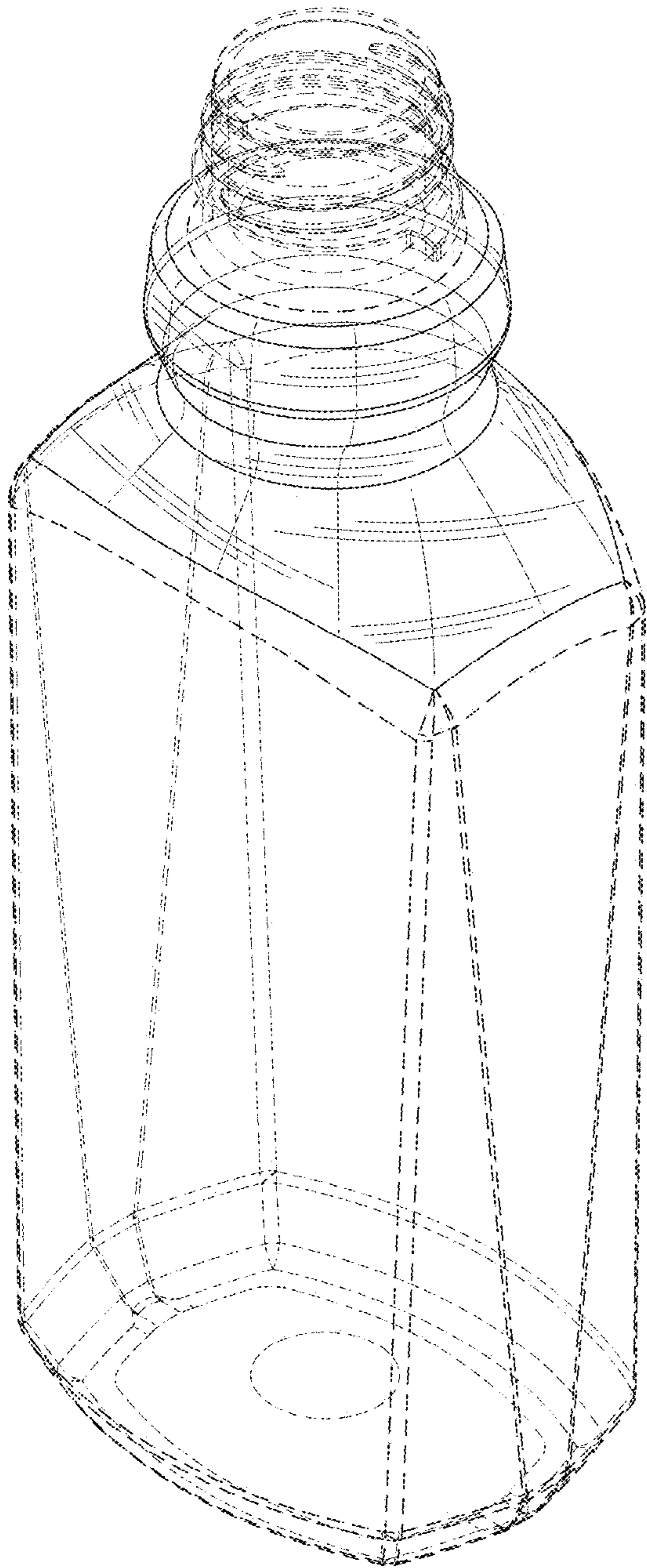

FIG. 22

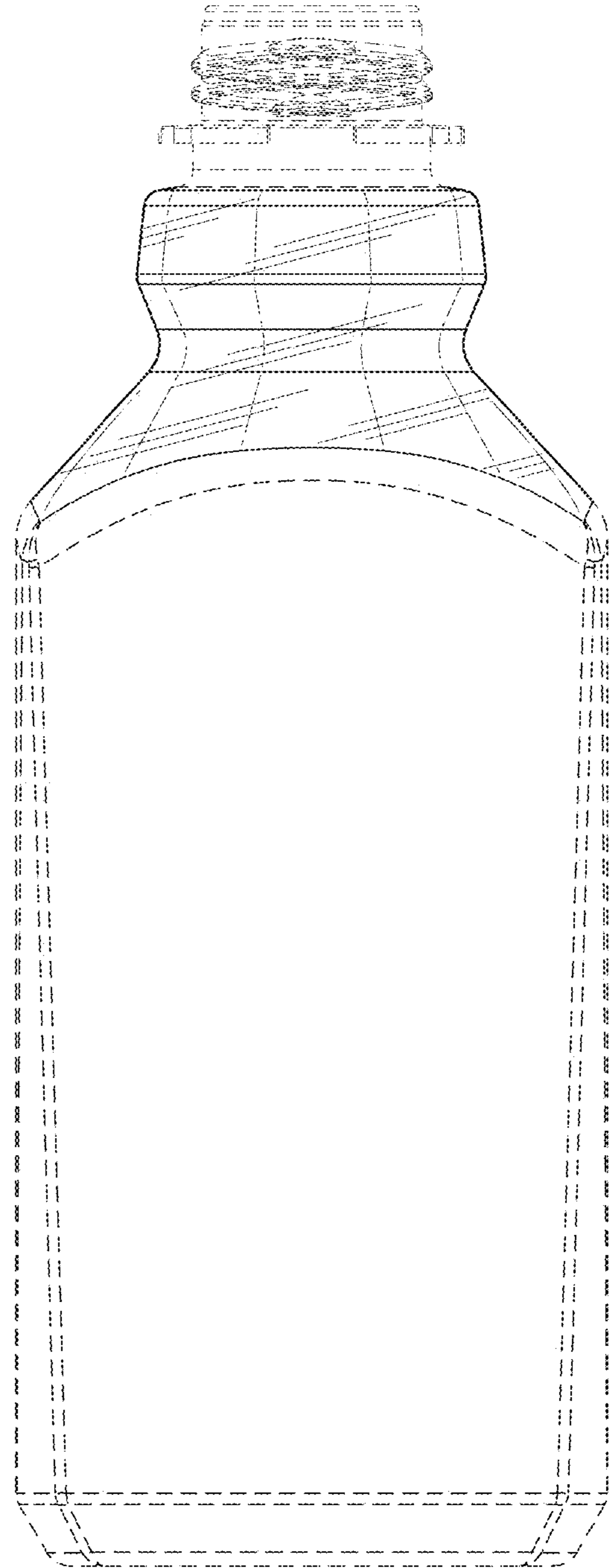

FIG. 23

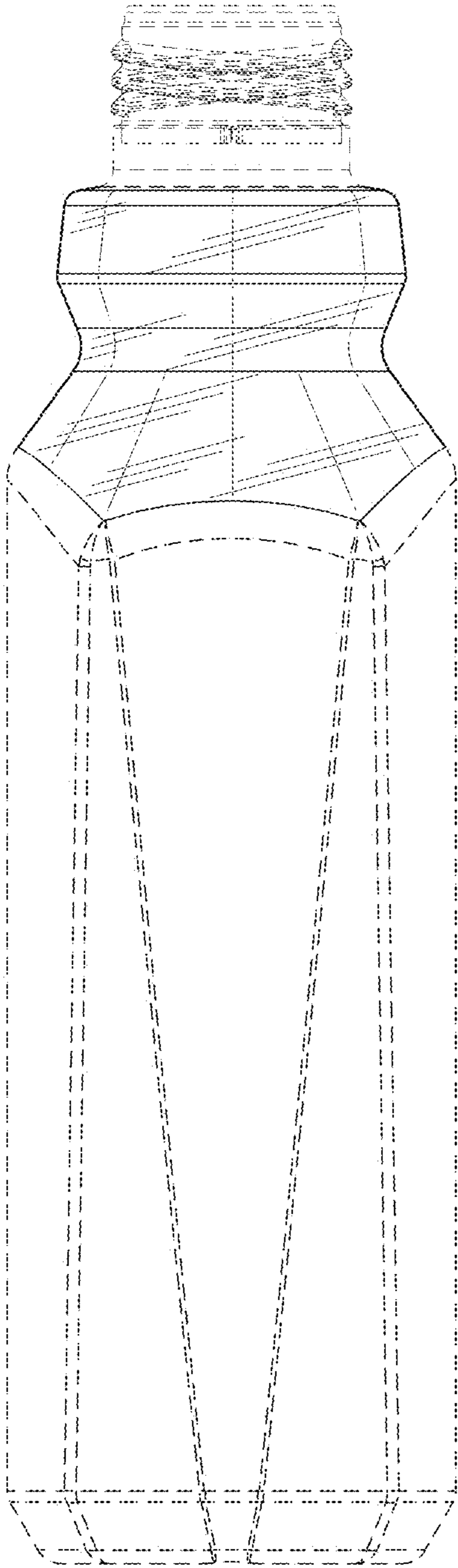

FIG. 24

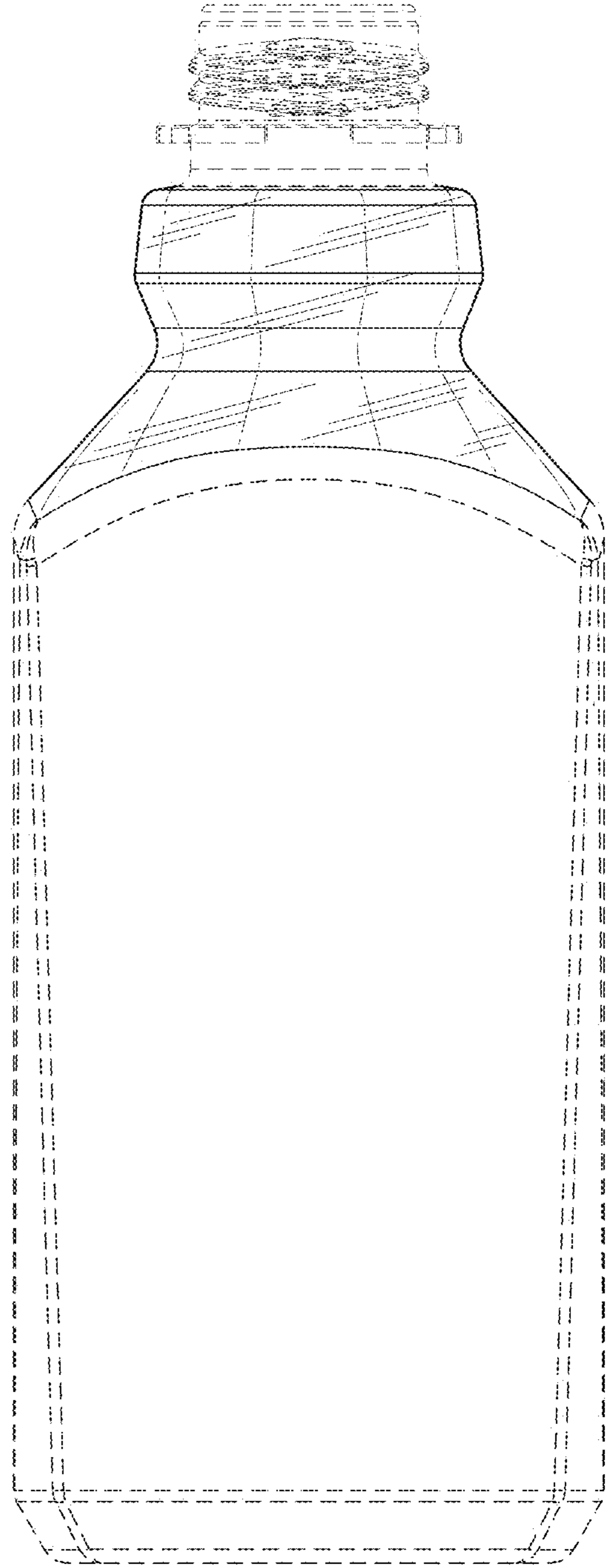

FIG. 25

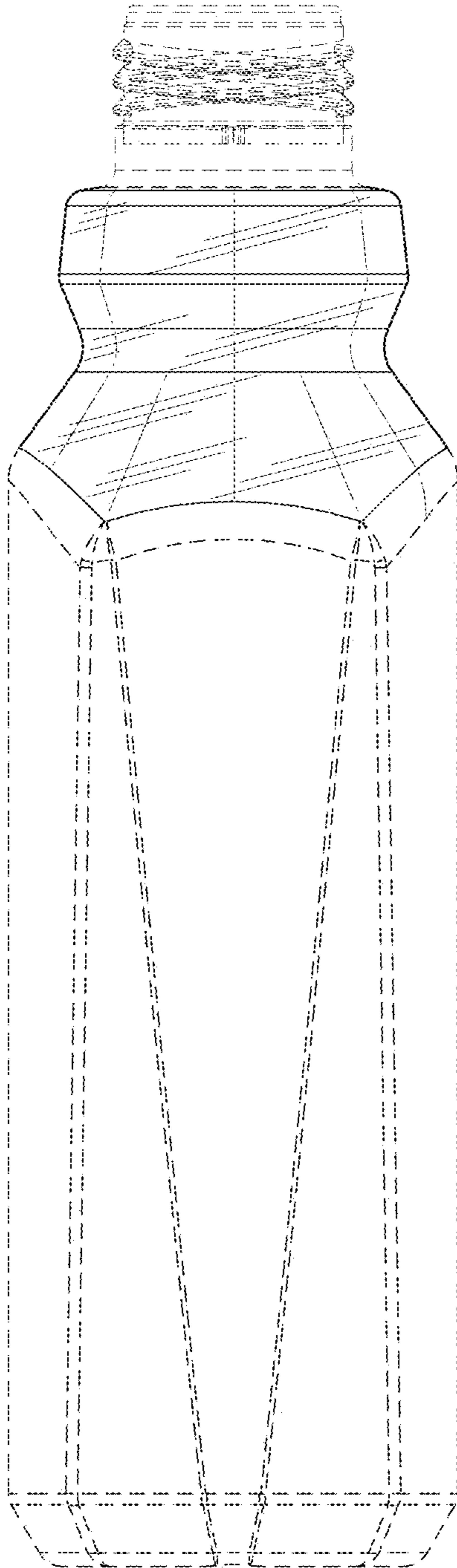

FIG. 26

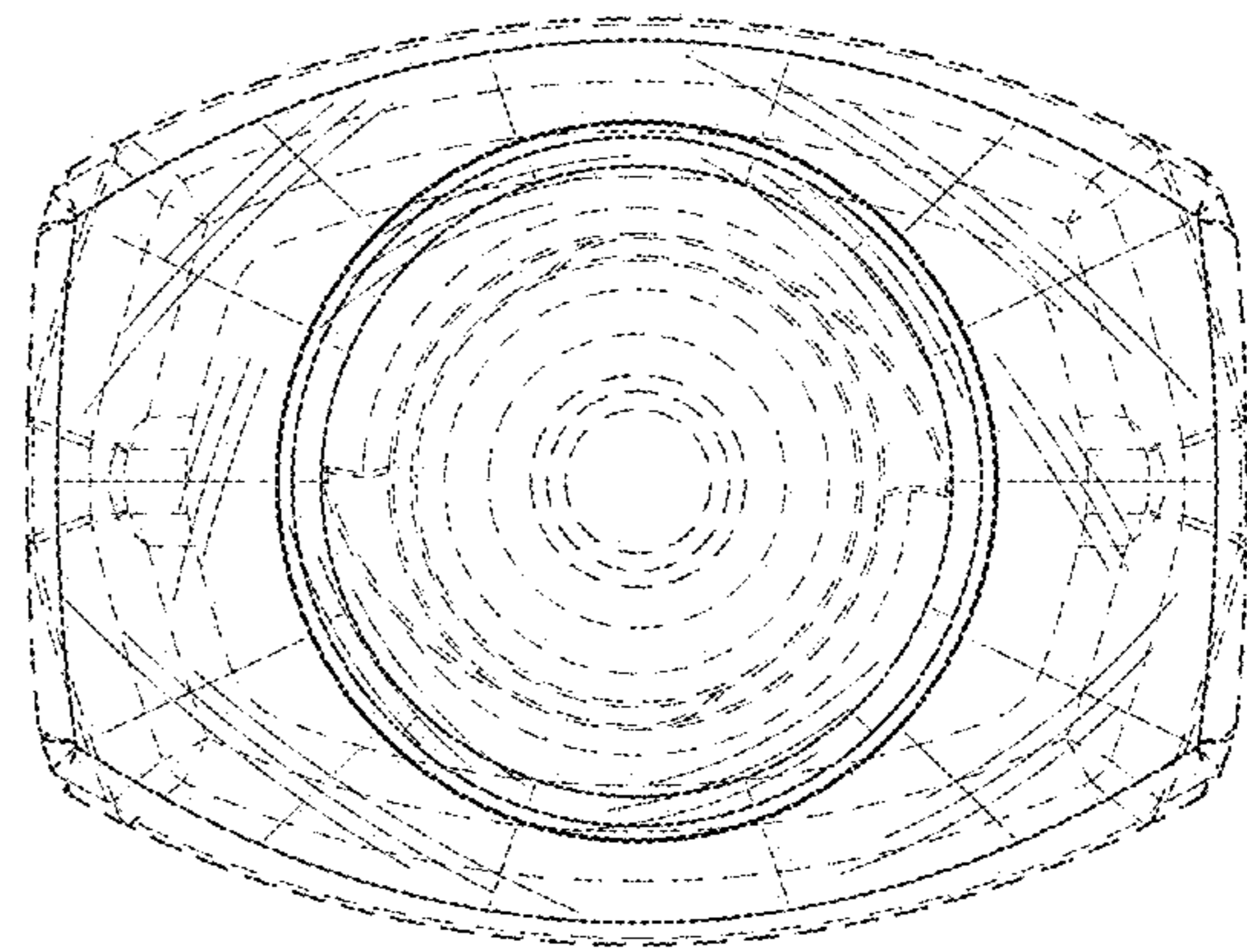

FIG. 27

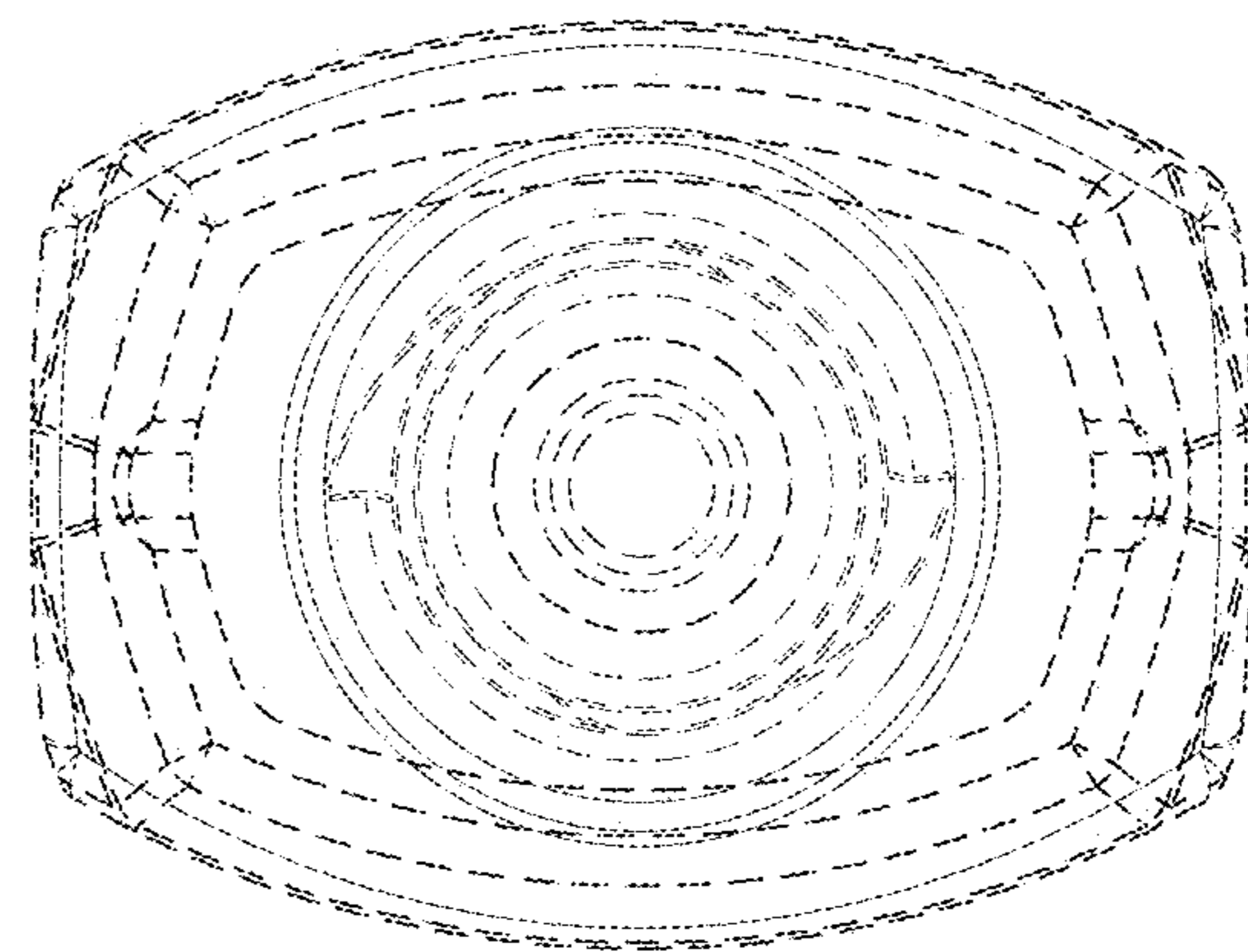

FIG. 28