



US00D886554S

(12) **United States Design Patent**
Dunne

(10) **Patent No.:** **US D886,554 S**

(45) **Date of Patent:** **** Jun. 9, 2020**

(54) **KNIFE BLOCK**

6,371,312 B1 * 4/2002 Tsuchida A47G 21/14
211/70.7

(71) Applicant: **FACKELMANN HOUSEWARES IP
PTY LTD**, Kingsgrove NSW (AU)

D564,304 S * 3/2008 Kosicki D7/637

D611,309 S * 3/2010 Bodum D7/637

D640,243 S * 6/2011 Murakami D14/240

D773,256 S * 12/2016 Plant D7/637

D773,902 S * 12/2016 Plant D7/637

(72) Inventor: **Brendan Dunne**, Lantau Is (HK)

(73) Assignee: **Fackelmann Housewares IP PTY
LTD**, Kingsgrove NSW (AU)

* cited by examiner

(**) Term: **15 Years**

Primary Examiner — Janice Patyk

(21) Appl. No.: **29/649,518**

(74) *Attorney, Agent, or Firm* — Mauriel Kapouytian

(22) Filed: **May 30, 2018**

Woods LLP; Serge Krimnus; Andrew A. Noble

(30) **Foreign Application Priority Data**

(57) **CLAIM**

May 24, 2018 (EP) 005280856

(51) **LOC (12) Cl.** **07-99**

(52) **U.S. Cl.**
USPC **D7/640**

(58) **Field of Classification Search**
USPC D7/637-641; 30/298.4; 211/60.1, 70.6,
211/70.7; 248/37.3, 37.6; D3/273, 274;
D19/77, 81-86

CPC A47B 88/20; A47F 7/00; A47G 21/00;
A47G 21/14; B26B 3/00

See application file for complete search history.

The ornamental design for a knife block, as shown and described.

DESCRIPTION

(56) **References Cited**

U.S. PATENT DOCUMENTS

D141,960 S * 8/1945 Glass D7/637

D444,355 S * 7/2001 Tramontina D7/631

FIG. 1 is a perspective view of a knife block, showing my new design.

FIG. 2 is a front view thereof.

FIG. 3 is a rear view thereof.

FIG. 4 is a top view thereof.

FIG. 5 is a bottom view thereof; and,

FIG. 6 is a side view thereof.

The broken lines in the figures illustrate the portions of the design that form no part of the claimed design.

1 Claim, 5 Drawing Sheets

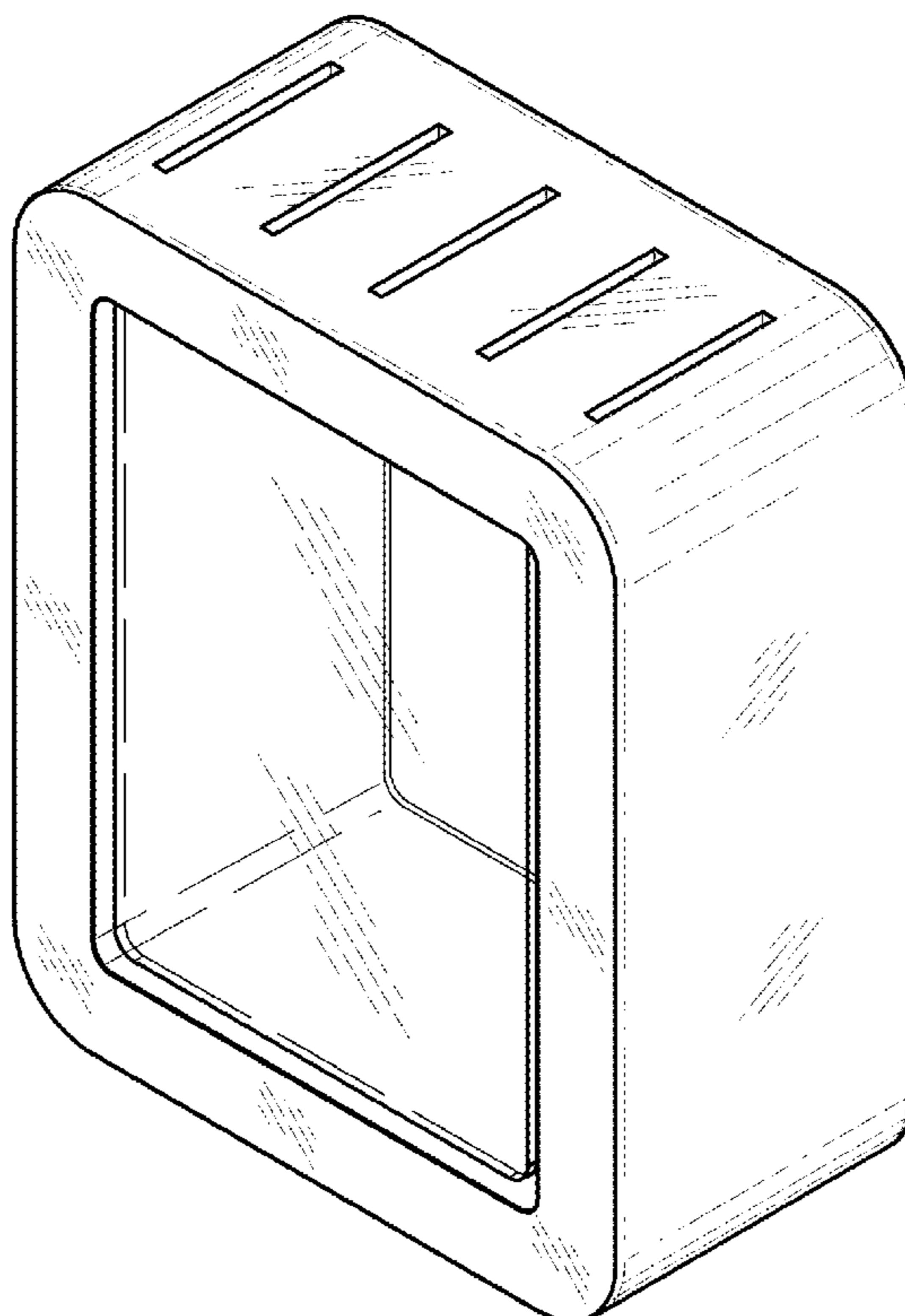

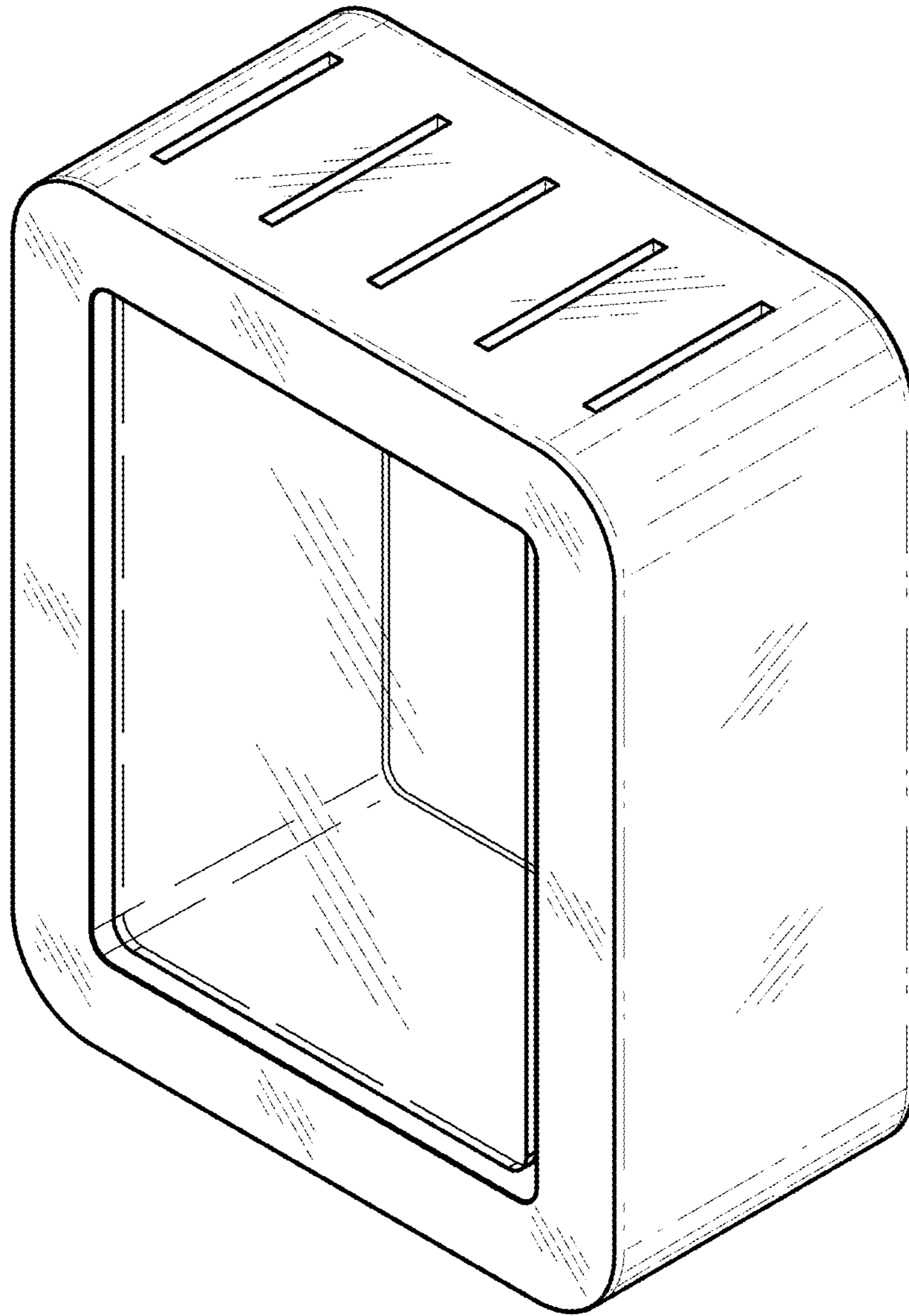

Figure 1

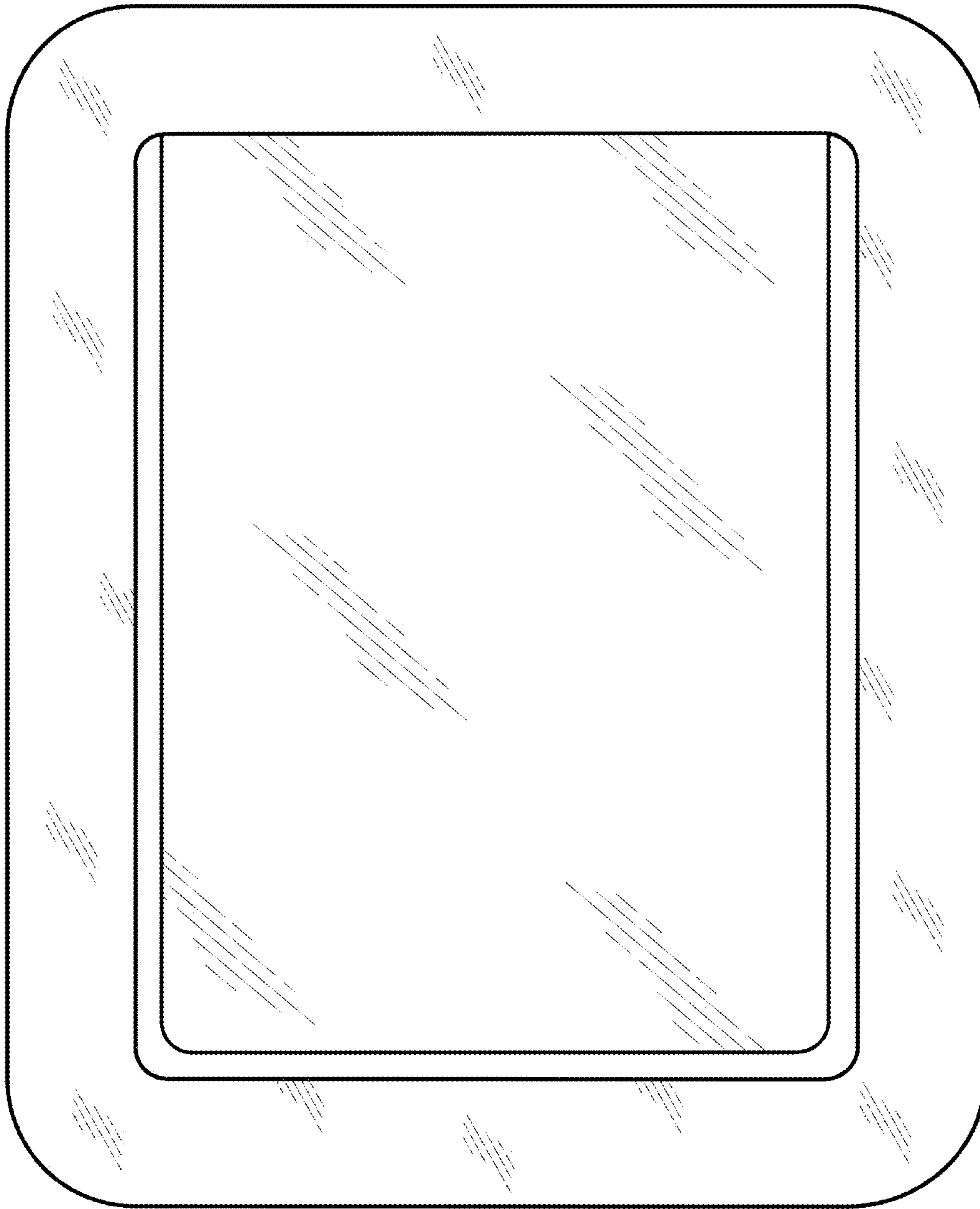

Figure 2

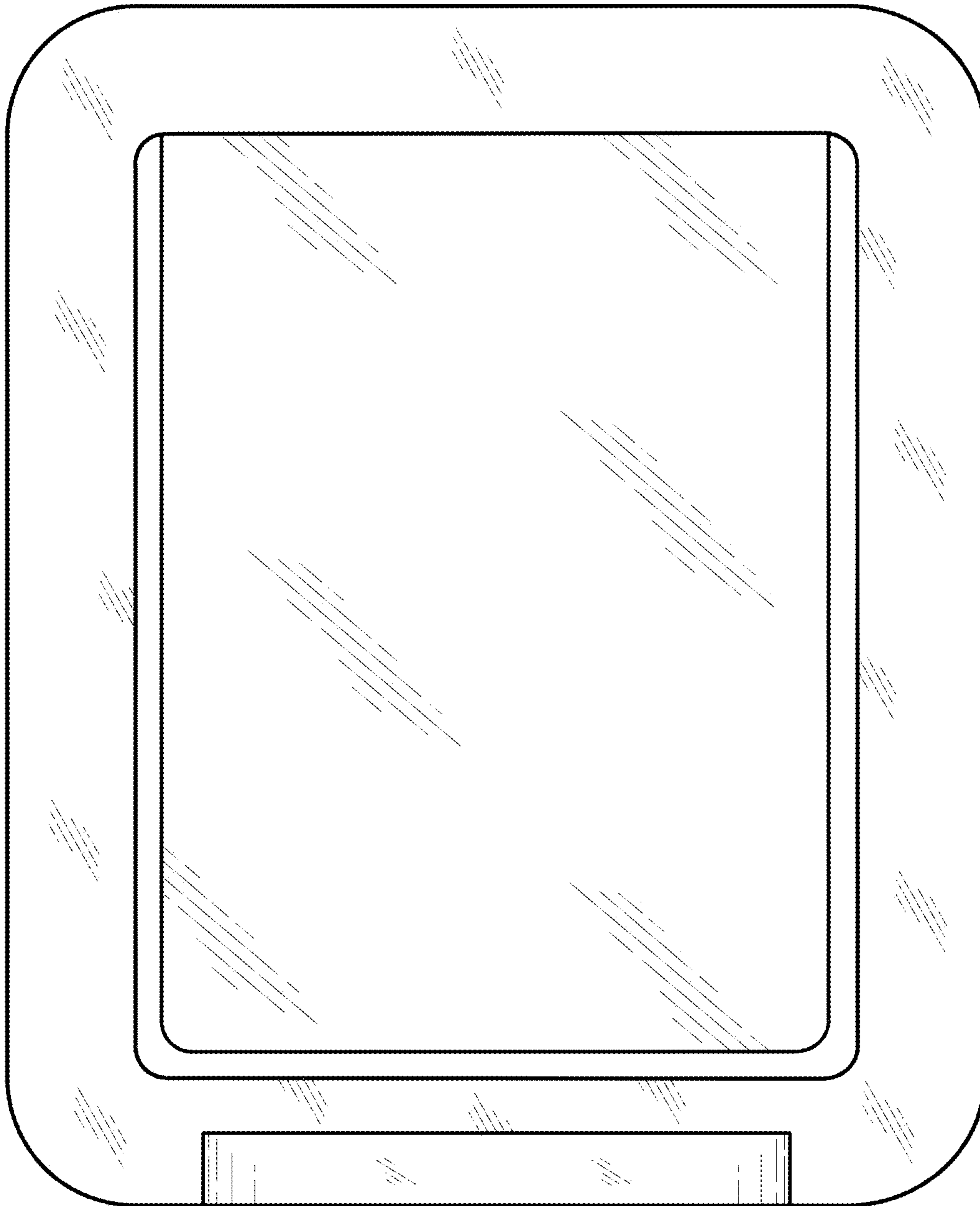

Figure 3

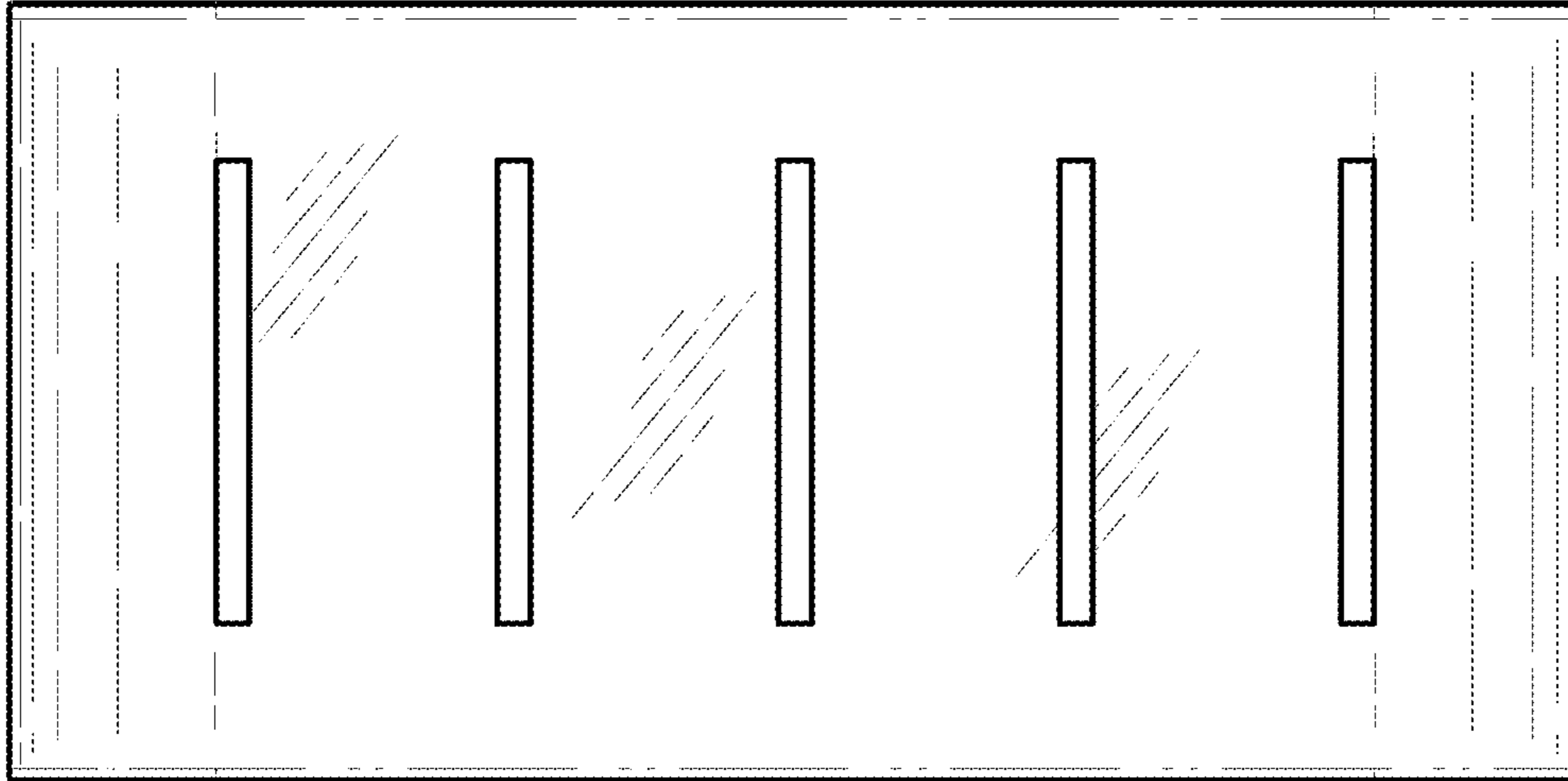

Figure 4

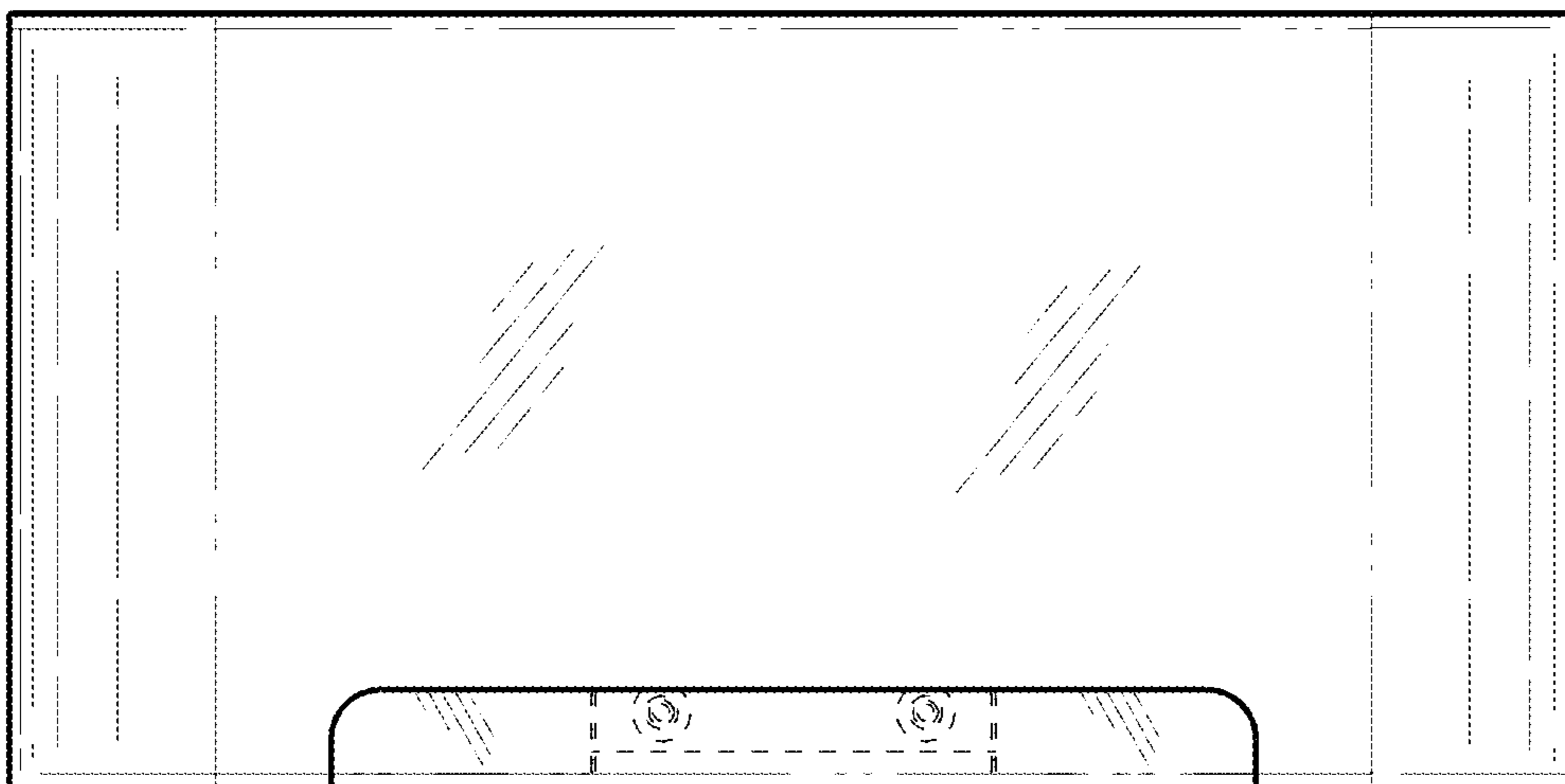

Figure 5

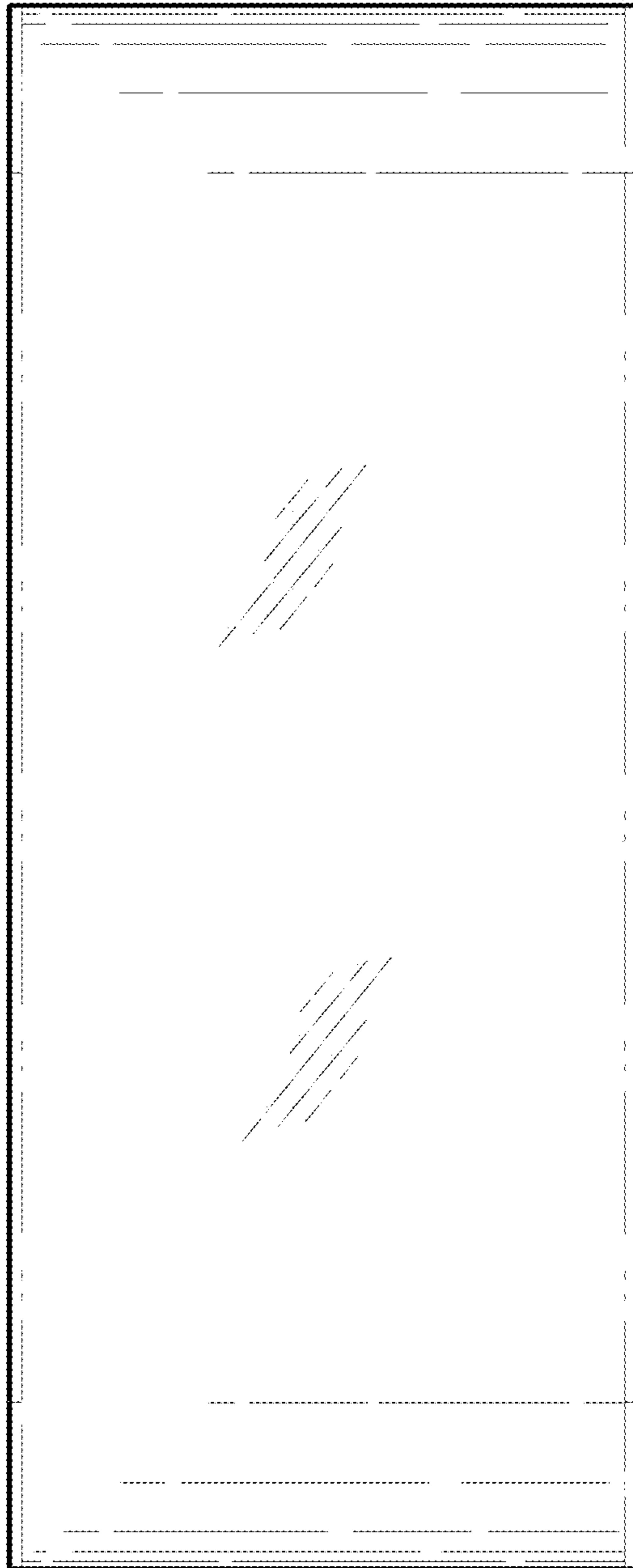

Figure 6