



US00D886457S

(12) **United States Design Patent**
Dobbins et al.

(10) **Patent No.:** **US D886,457 S**

(45) **Date of Patent:** **** Jun. 9, 2020**

(54) **HANDBAG**

(71) Applicant: **Offero, LLC**, Birmingham, AL (US)

(72) Inventors: **Linda Dobbins**, Birmingham, AL (US);
Anna Marie Dobbins, Studio City, CA (US)

(73) Assignee: **Offero, LLC**, Birmingham, AL (US)

(**) Term: **15 Years**

(21) Appl. No.: **29/662,300**

(22) Filed: **Sep. 4, 2018**

(51) **LOC (12) Cl.** **03-01**

(52) **U.S. Cl.**
USPC **D3/318**

(58) **Field of Classification Search**
USPC D3/232-233, 240-243, 245-246, 318
CPC A45C 1/024; A45C 3/06
See application file for complete search history.

(56) **References Cited**

U.S. PATENT DOCUMENTS

D586,560 S * 2/2009 Gonzalez D3/318
7,913,849 B2 * 3/2011 Pedrazzi A45C 11/20
206/232

D685,996 S * 7/2013 Zander D3/318
D711,654 S * 8/2014 Kuster D3/318
D776,933 S * 1/2017 Shou D3/327
D798,601 S * 10/2017 Shou D3/327
D848,741 S * 5/2019 Galanti D3/318

* cited by examiner

Primary Examiner — Holly H Baynham

(74) *Attorney, Agent, or Firm* — Banner & Witcoff, Ltd.

(57) **CLAIM**

The ornamental design for a handbag, as shown and described.

DESCRIPTION

FIG. 1 is a bottom perspective view of a handbag showing our new design;

FIG. 2 is a bottom view thereof;

FIG. 3 is a top view thereof;

FIG. 4 is a front view thereof;

FIG. 5 is a rear view thereof;

FIG. 6 is a right side view thereof; and,

FIG. 7 is a left side view thereof.

The broken lines immediately adjacent to the claimed areas represent the bounds of the claimed design and form no part thereof. The broken lines depicting of the remainder of the handbag show features that form no part of the claimed design.

1 Claim, 5 Drawing Sheets

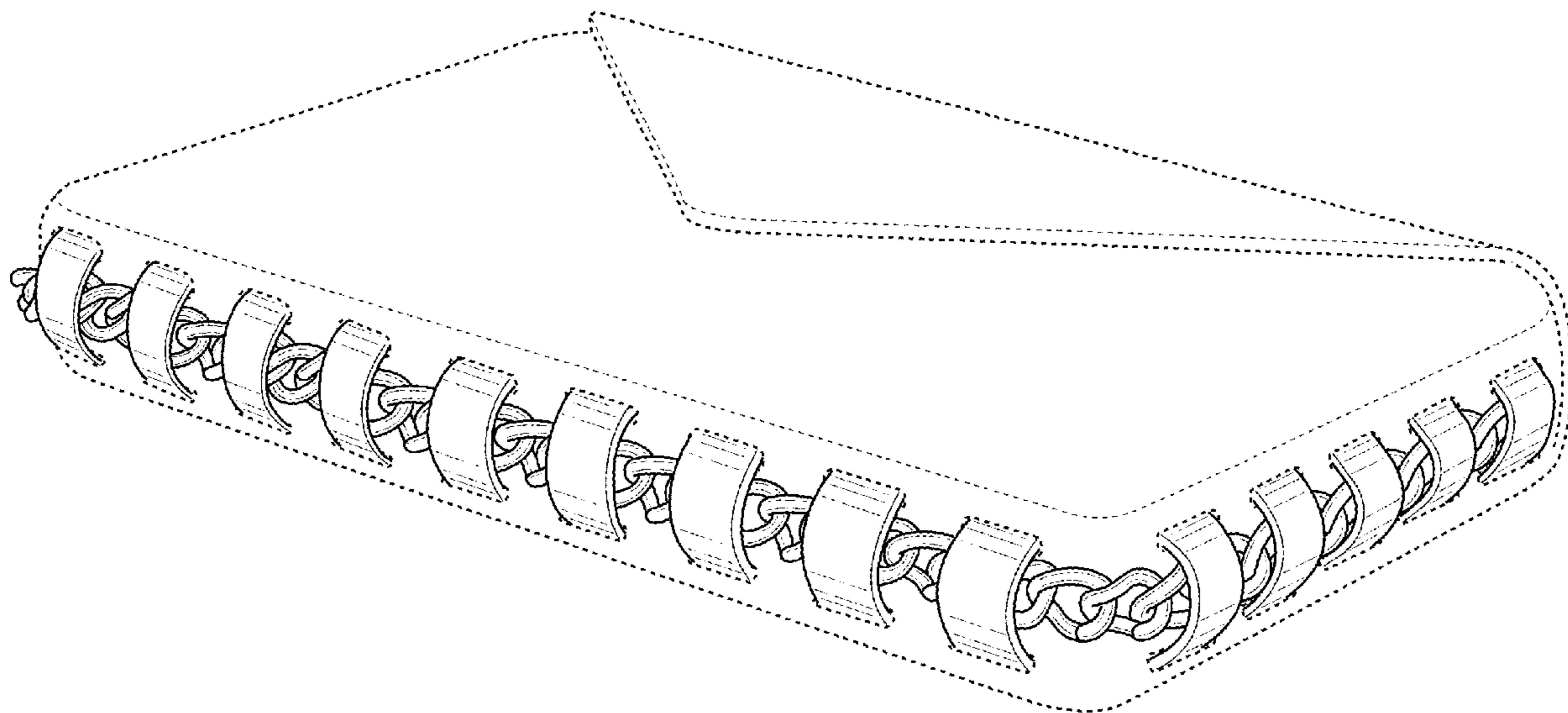

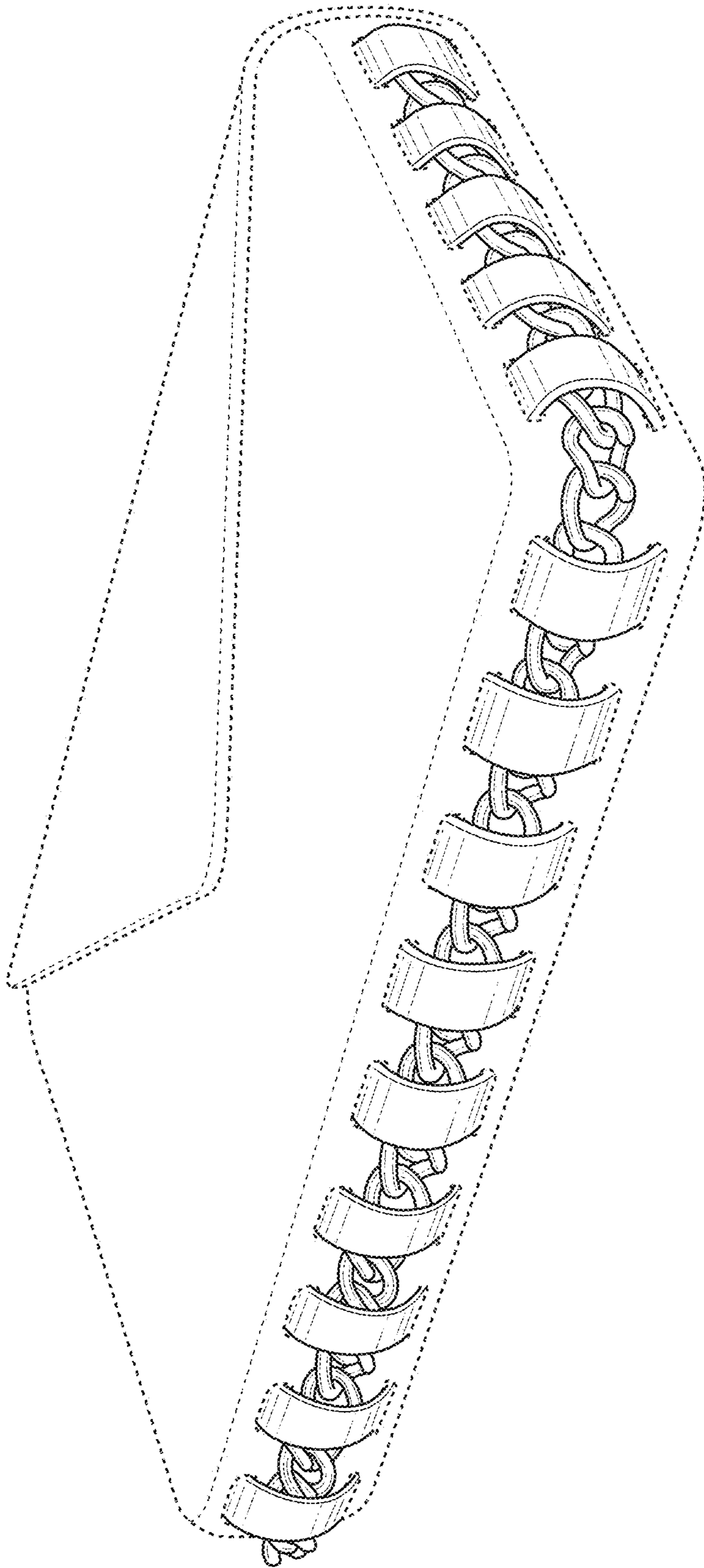

FIG. 1

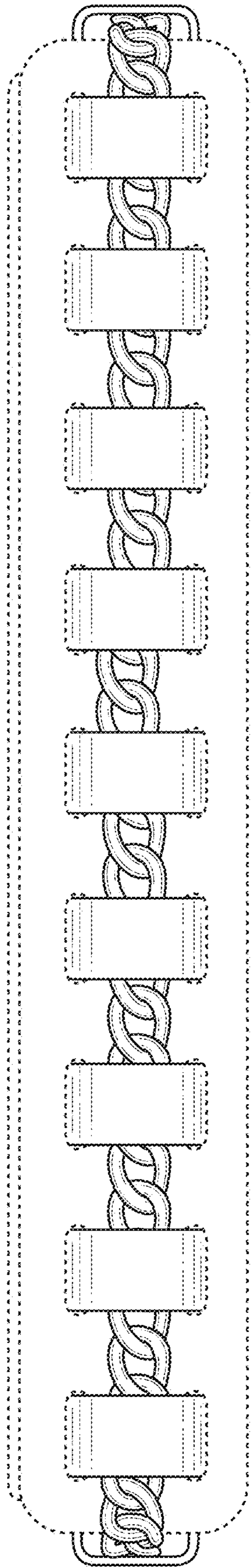

FIG. 2

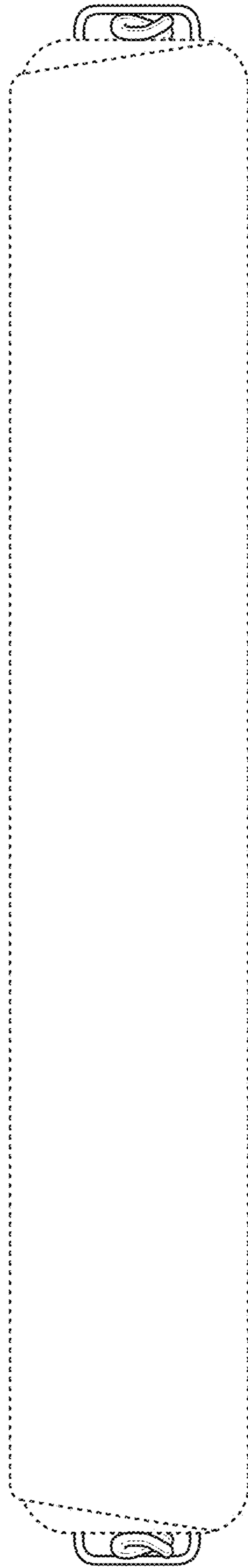

FIG. 3

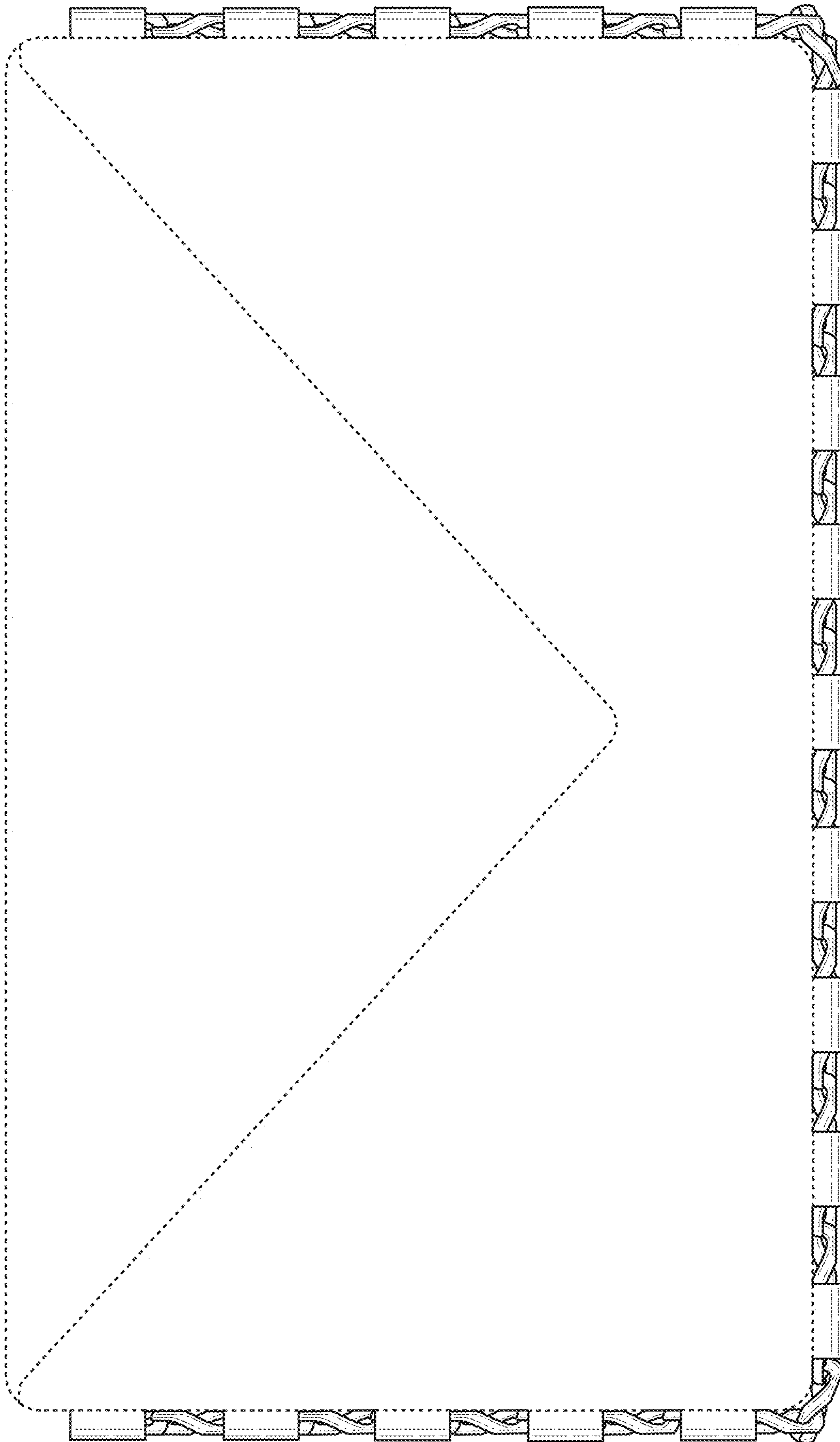

FIG. 4

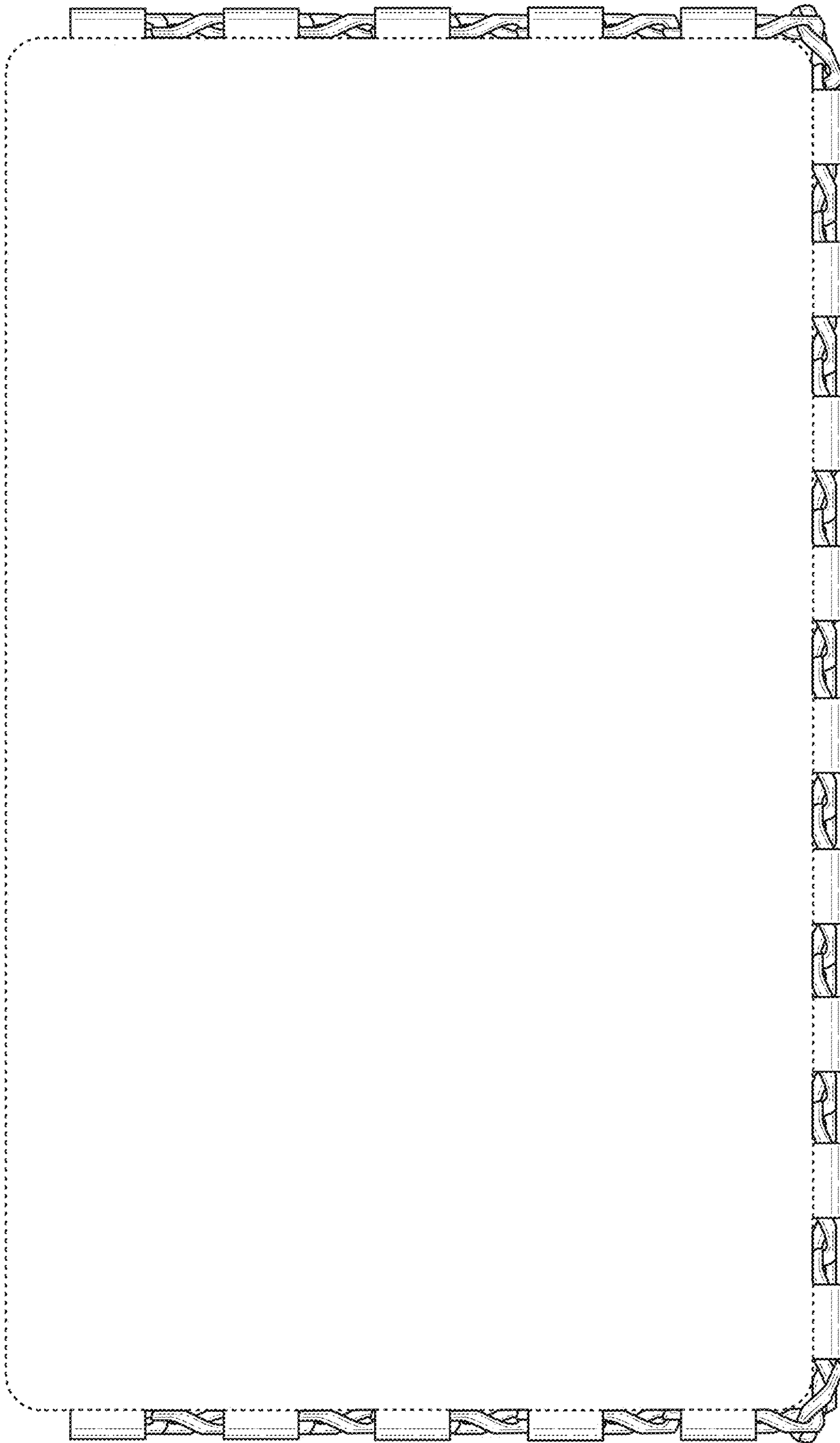

FIG. 5

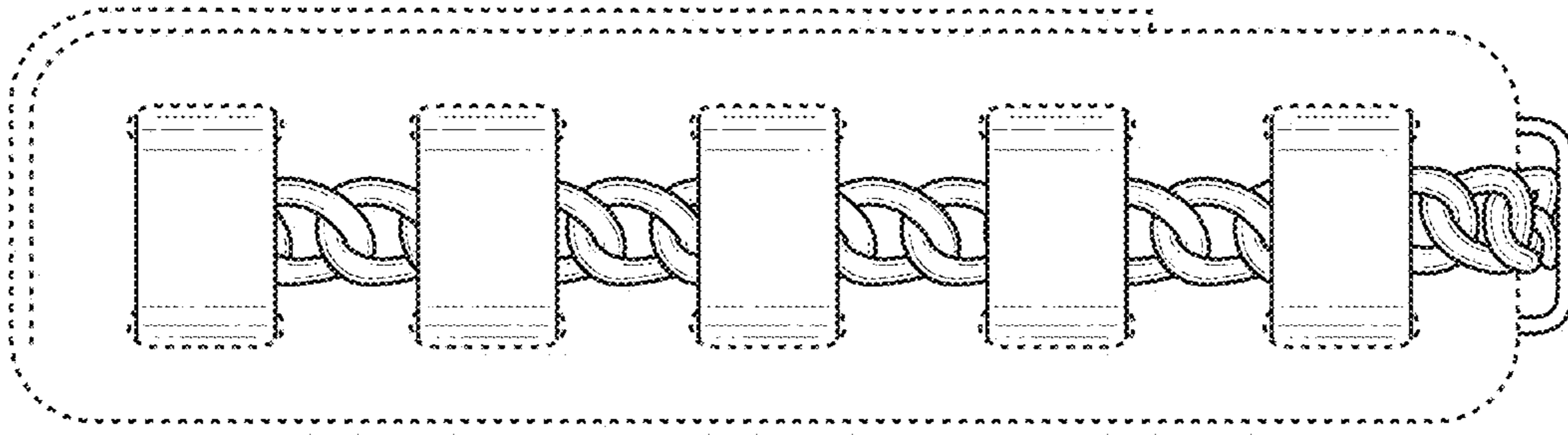

FIG. 7

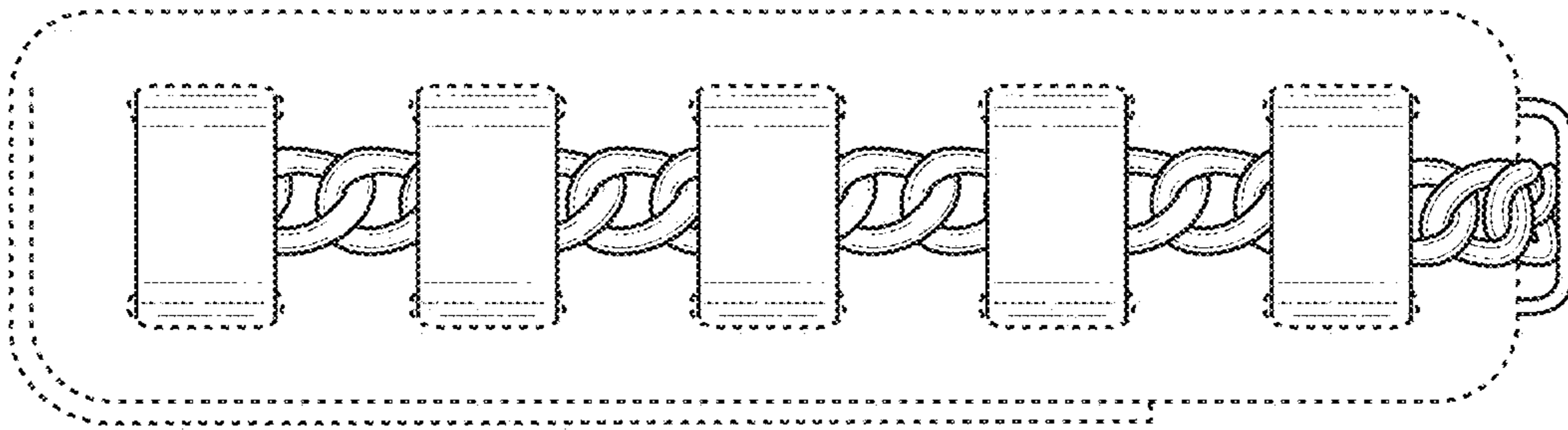

FIG. 6