



US00D886437S

(12) **United States Design Patent**  
**Taylor**

(10) **Patent No.:** **US D886,437 S**

(45) **Date of Patent:** **\*\* Jun. 9, 2020**

(54) **SHOE**

(71) Applicant: **NIKE, Inc.**, Beaverton, OR (US)

(72) Inventor: **Justin R. Taylor**, Portland, OR (US)

(73) Assignee: **NIKE, Inc.**, Beaverton, OR (US)

(\*\*) Term: **15 Years**

(21) Appl. No.: **29/648,193**

(22) Filed: **May 18, 2018**

(51) **LOC (12) Cl.** ..... **02-04**

(52) **U.S. Cl.**  
USPC ..... **D2/972**

(58) **Field of Classification Search**  
USPC ..... D2/896, 897, 902, 904, 906-908,  
D2/943-947, 969, 972-974; D5/47, 48,  
D5/49, 50, 51, 53, 54, 56, 60  
CPC ... A43B 13/181; A43B 13/141; A43B 13/186;  
A43B 13/188; A43B 23/00; A43B 23/02;  
A43B 5/00; A43B 23/26; A43B 1/04;  
A43B 11/14; A43B 7/00; A43B 3/12;  
A43C 3/00; A43C 5/00; A43C 7/00;  
A43C 11/004  
See application file for complete search history.

(56) **References Cited**

**U.S. PATENT DOCUMENTS**

D173,030 S	*	9/1954	Hoza	.....	D2/902
D271,633 S	*	12/1983	Casetta	.....	D2/902
D278,758 S	*	5/1985	Michaeli	.....	D2/969
D337,648 S	*	7/1993	Avar	.....	D2/969
D342,600 S	*	12/1993	Hatfield	.....	D2/969

D346,485 S	*	5/1994	Vestuti	.....	D2/972
D419,756 S	*	2/2000	Edwards	.....	D2/902
D473,705 S	*	4/2003	Nason	.....	D2/972
D563,645 S	*	3/2008	Horne	.....	D2/969
D861,296 S	*	10/2019	Maxwell Weeks	.....	D2/923
D876,073 S	*	2/2020	Atwell	.....	D2/972
D878,730 S	*	3/2020	Van De Stouwe	.....	D2/969
D879,454 S	*	3/2020	Petrenka	.....	D2/972

\* cited by examiner

*Primary Examiner* — Dominic V Simone

(74) *Attorney, Agent, or Firm* — Banner & Witcoff, Ltd.

(57) **CLAIM**

The ornamental design for a shoe, as shown and described.

**DESCRIPTION**

FIG. 1 is a rear perspective view of a shoe showing my new design;  
 FIG. 2 is a side view thereof;  
 FIG. 3 is a front perspective view thereof;  
 FIG. 4 is a front view thereof;  
 FIG. 5 is a front perspective view of the second side thereof;  
 FIG. 6 is a second side view thereof;  
 FIG. 7 is a rear perspective view of the second side thereof;  
 and,  
 FIG. 8 is a top view thereof.

The broken lines immediately adjacent to the lower portions of the shaded area define bounds of the claimed design and form no part thereof. The broken lines depicting the remainder of the shoe show features that form no part of the claimed design.

**1 Claim, 8 Drawing Sheets**

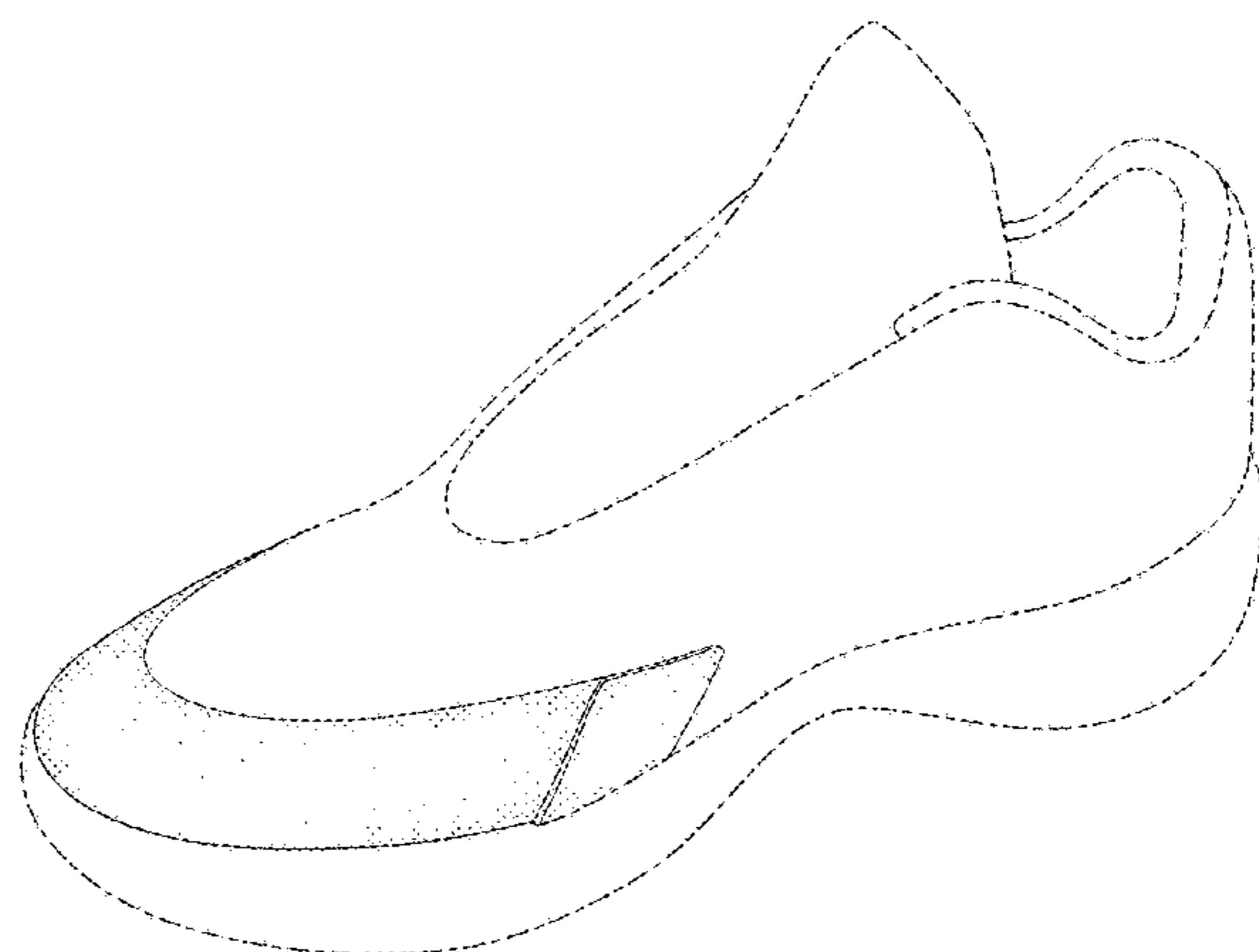
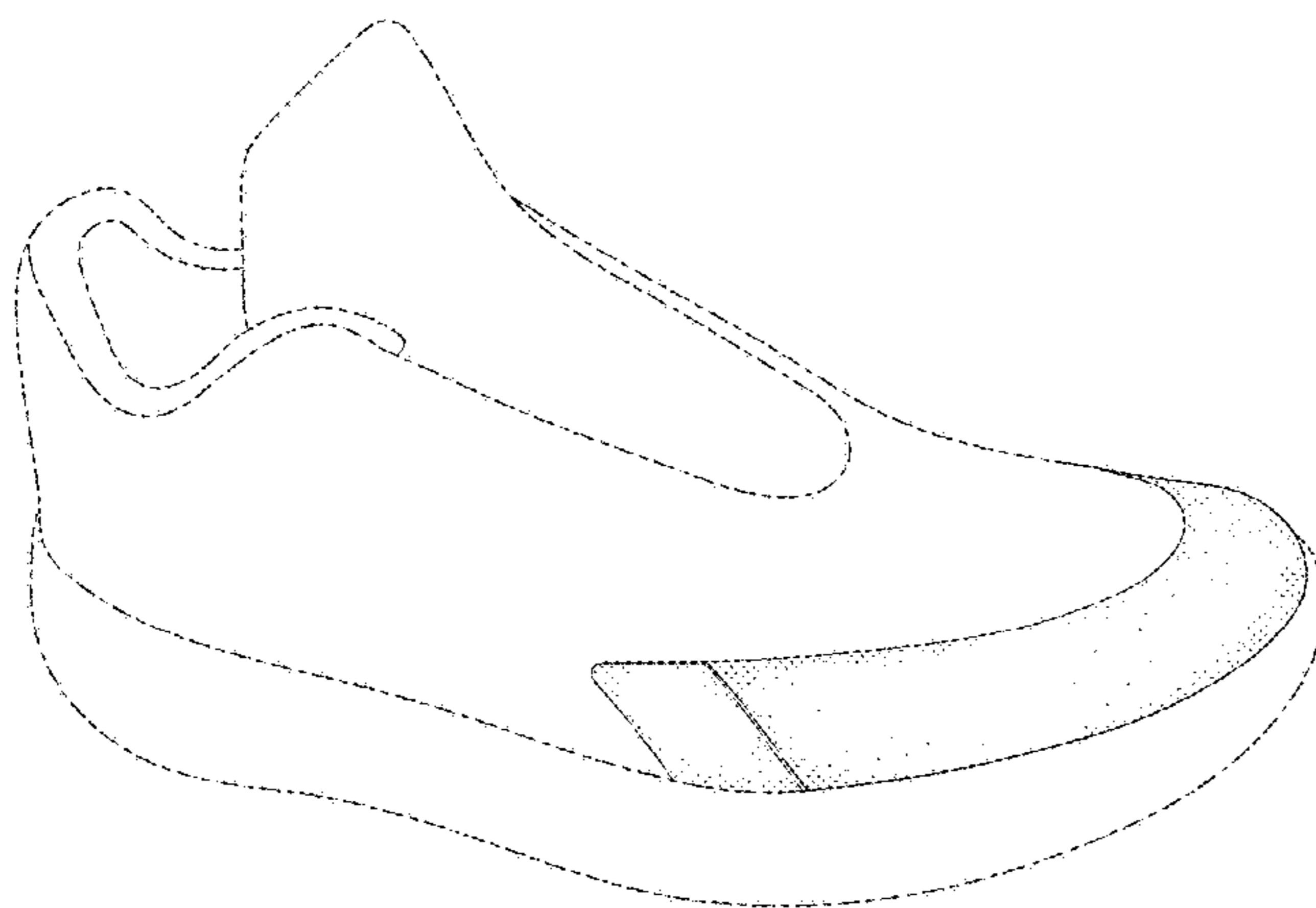

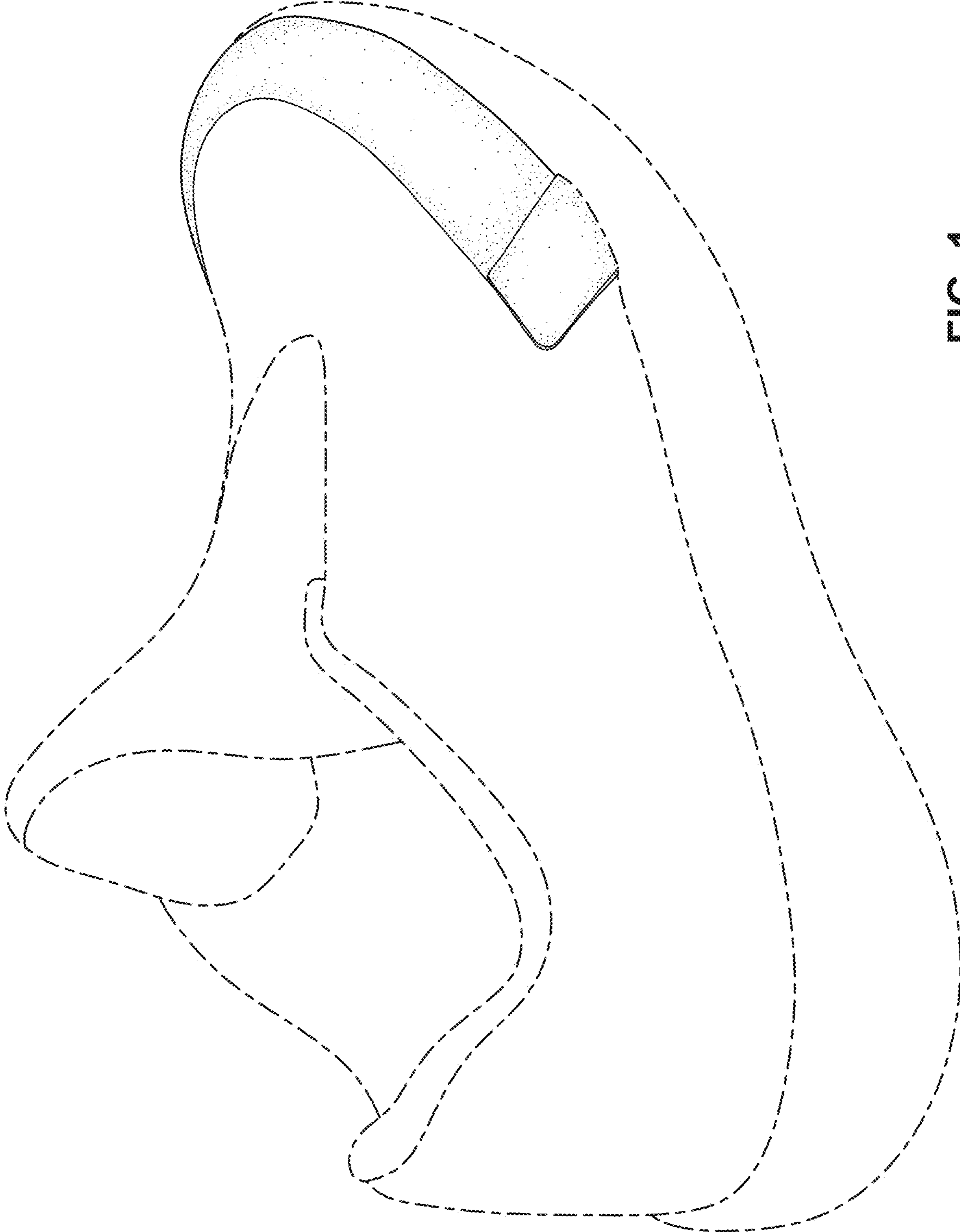

FIG. 1

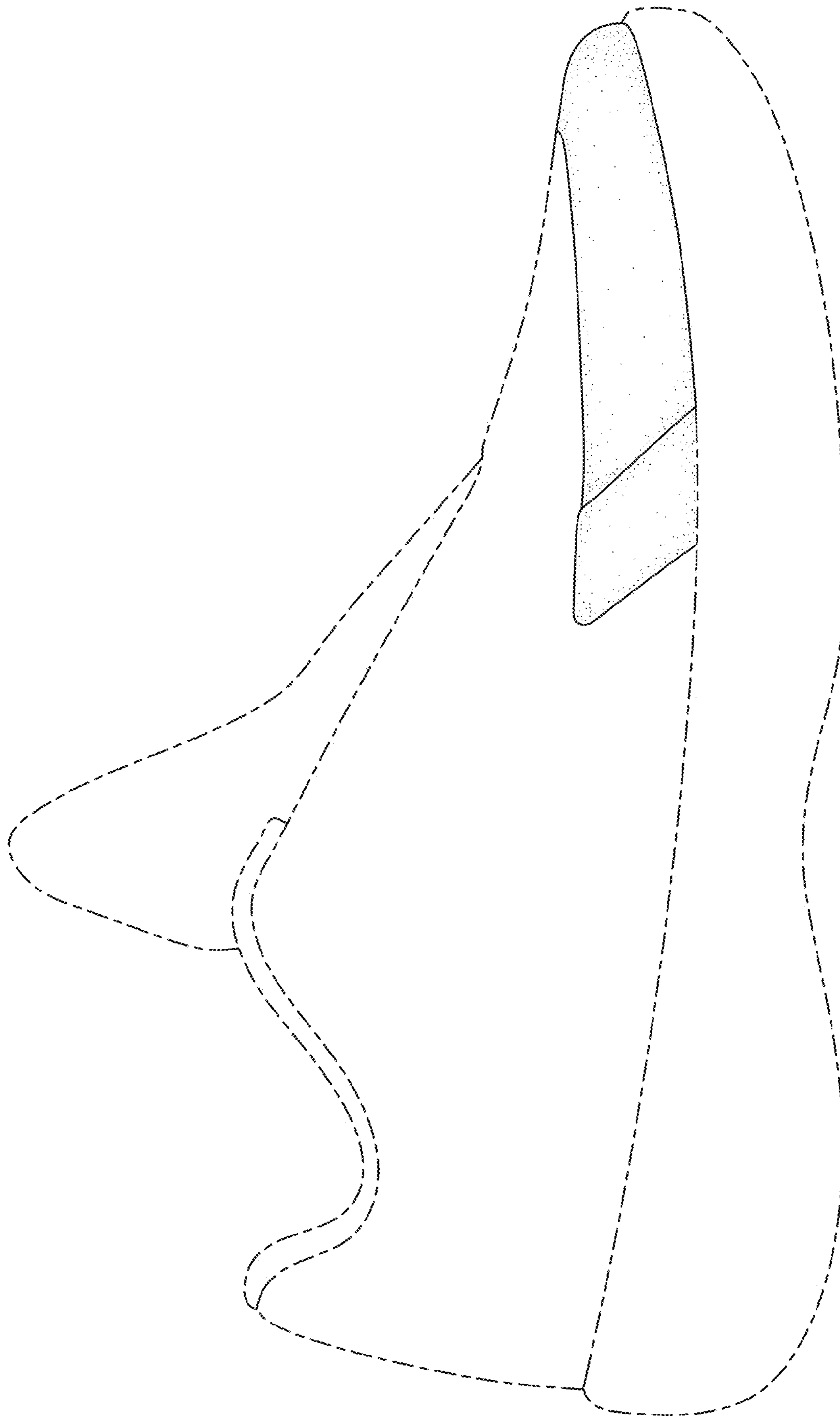

FIG. 2

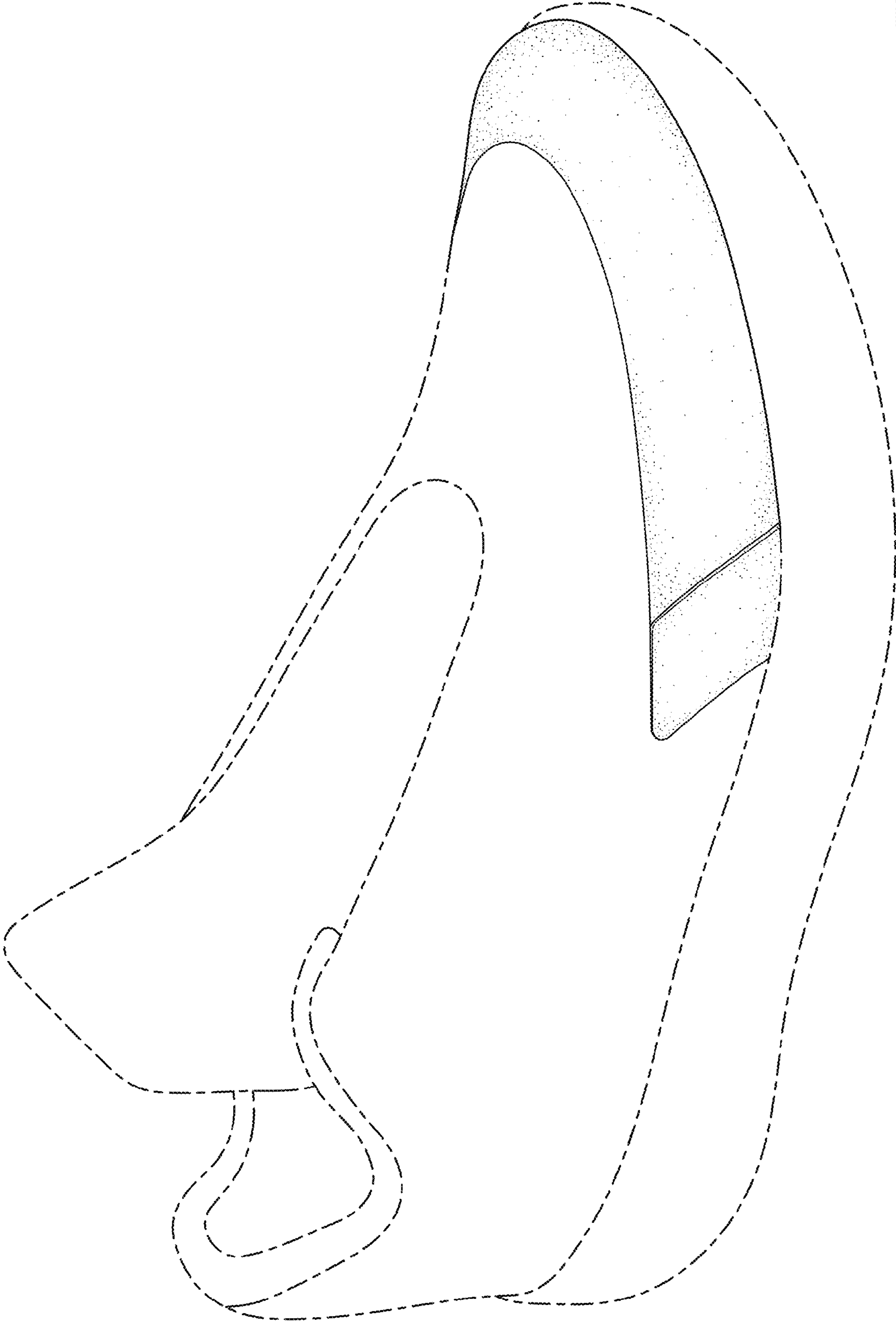

FIG. 3

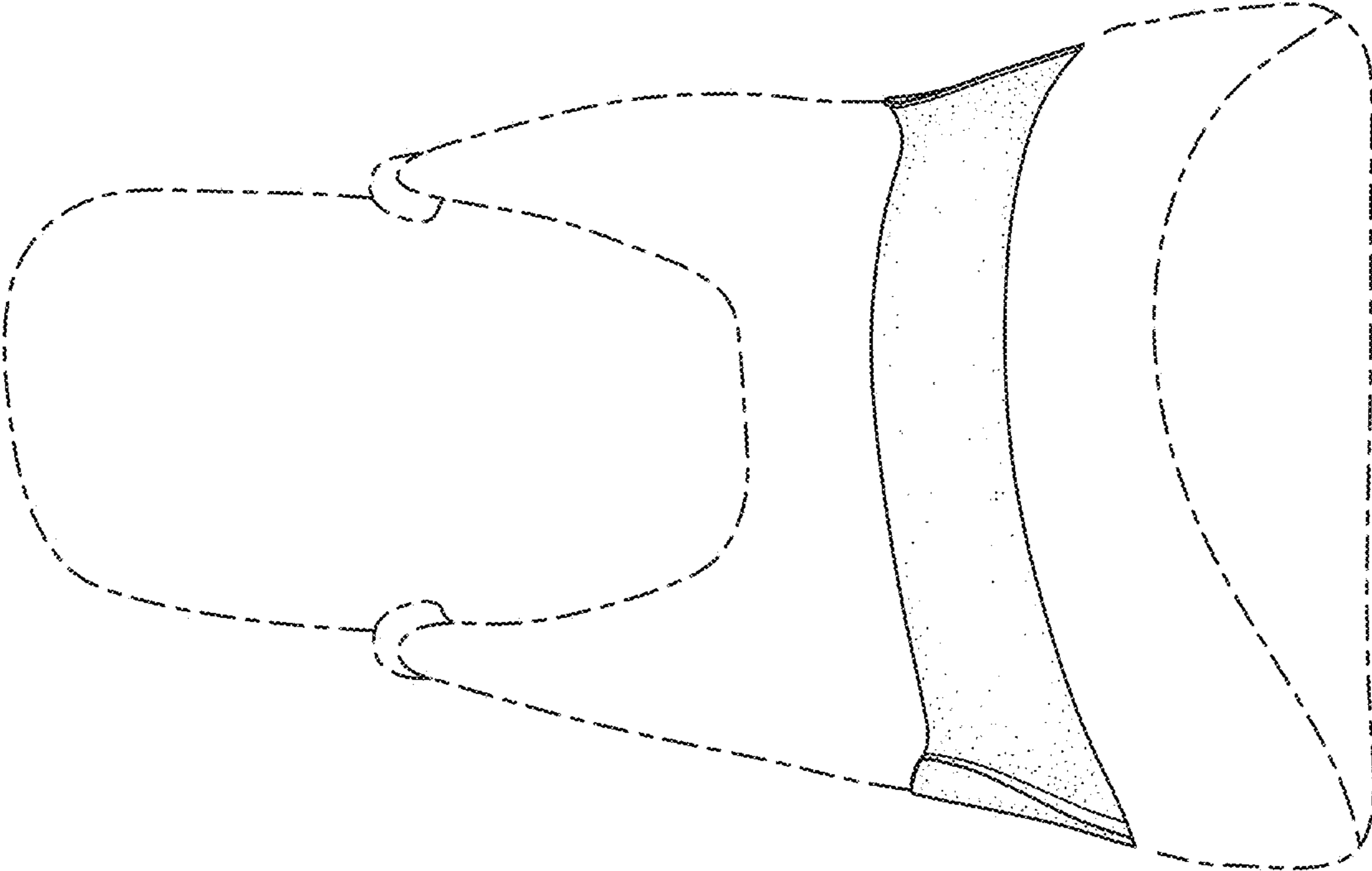

FIG. 4

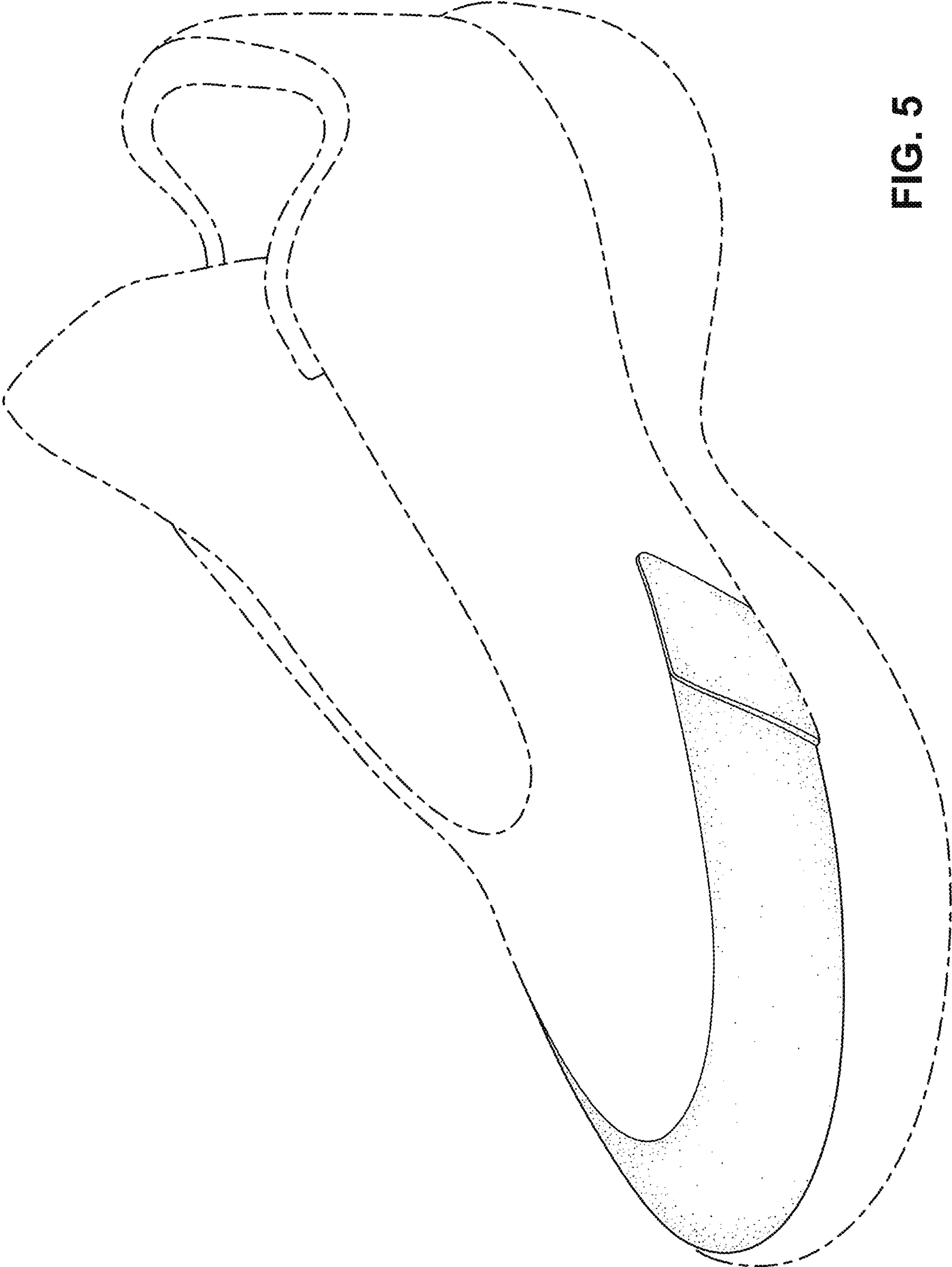

FIG. 5



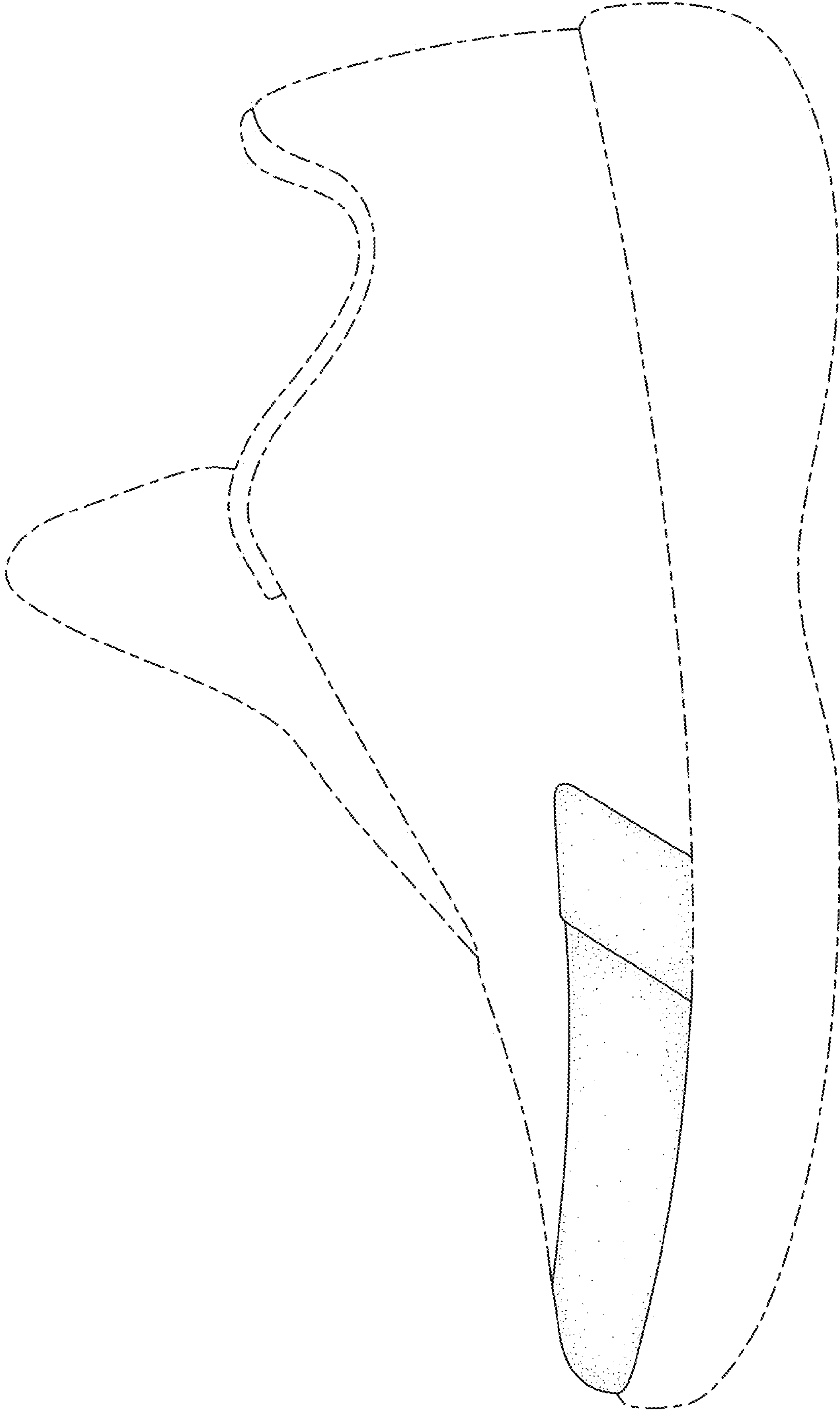

FIG. 6

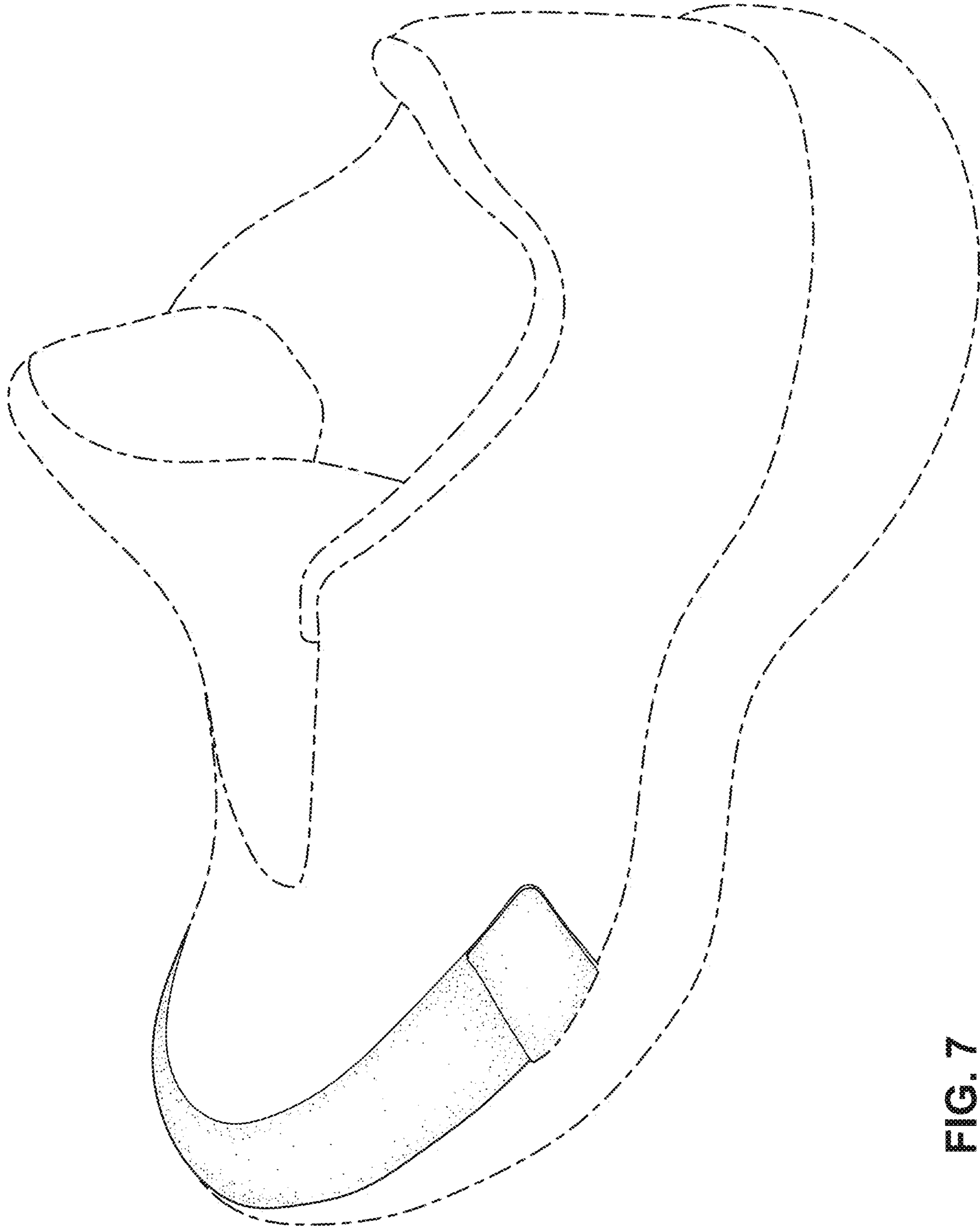

FIG. 7



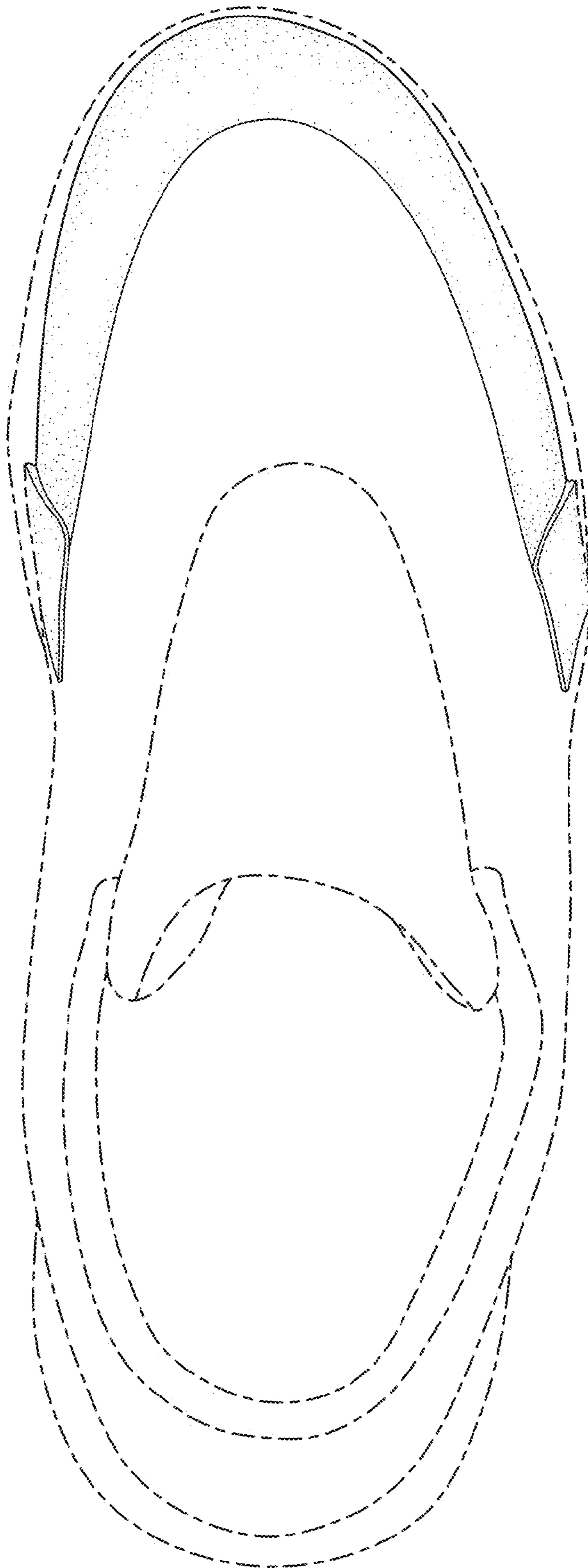

FIG. 8