



US00D886435S

(12) **United States Design Patent** (10) **Patent No.:** **US D886,435 S**  
**Gavrieli et al.** (45) **Date of Patent:** **\*\* \*Jun. 9, 2020**

- (54) **SHOE WITH DUAL OUTPATCH SOLE**
- (71) Applicant: **Gavrieli Brands LLC**, Beverly Hills, CA (US)
- (72) Inventors: **Kfir Gavrieli**, Beverly Hills, CA (US); **Dikla Gavrieli**, Beverly Hills, CA (US)
- (73) Assignee: **Gavrieli Brands LLC**, Beverly Hills, CA (US)
- (\*) Notice: This patent is subject to a terminal disclaimer.
- (\*\*) Term: **15 Years**
- (21) Appl. No.: **29/649,460**
- (22) Filed: **May 30, 2018**

CPC ..... A43B 21/00; A43B 21/02; A43B 21/06; A43B 9/14; A43B 1/0045; A43B 13/10; A43B 13/12; A43B 23/06; A43B 23/07; A43B 1/0036; A43B 5/12

See application file for complete search history.

(56) **References Cited**

U.S. PATENT DOCUMENTS

249,086 A	11/1881	Pienovi	
773,850 A	11/1904	Cooper et al.	
830,941 A	9/1906	Walden	
1,208,209 A	12/1916	Prince	
1,214,666 A	2/1917	Ford	
1,519,009 A	12/1924	Reina	
1,525,848 A *	2/1925	Bonaventure .....	A43B 5/12 36/8.3
1,587,377 A	6/1926	Grosjean	
1,650,466 A	11/1927	Righter	
2,224,590 A	12/1940	Boivin	
2,268,777 A	1/1942	Scholl	
D133,819 S *	9/1942	Harris .....	D2/939
D135,791 S	6/1943	Beebe	
2,323,563 A	7/1943	Nugent	
2,342,882 A	2/1944	Meltzer	
D141,871 S	7/1945	Braun	
2,383,585 A	8/1945	Bindner	
D149,685 S *	5/1948	Sandler .....	D2/935
D150,729 S *	8/1948	Sandler .....	D2/923
D166,090 S *	3/1952	Maling .....	A43B 13/14 D2/897
2,772,488 A	12/1956	Meltzer	
2,904,814 A	9/1959	Scholl	
3,148,378 A	9/1964	Tibbitts	
D200,897 S *	4/1965	Mitchell .....	D2/919
D220,464 S	4/1971	Hayoshi	
D247,396 S *	3/1978	Schlerth .....	D2/939
4,412,393 A	11/1983	Terlizzi, Jr. et al.	
D275,525 S	9/1984	Nakao	
4,674,206 A	6/1987	Lyden	
D295,692 S *	5/1988	Zuidema .....	D2/950
D300,085 S	3/1989	Ito et al.	
RE33,018 E	8/1989	Ostrander	
4,899,412 A	2/1990	Ganon	
D316,773 S	5/1991	Valle	
5,012,541 A	5/1991	Ganon	
D339,669 S *	9/1993	Miller .....	D2/939
5,282,326 A	2/1994	Schroer, Jr. et al.	
5,421,050 A	6/1995	Laganas	
5,699,629 A	12/1997	Munschy	
5,746,014 A	5/1998	Tanemoto	

**Related U.S. Application Data**

- (63) Continuation of application No. 15/905,239, filed on Feb. 26, 2018, which is a continuation of application No. 15/204,763, filed on Jul. 7, 2016, now Pat. No. 9,930,925, and a continuation of application No. 29/570,429, filed on Jul. 7, 2016, now Pat. No. Des. 819,940, which is a continuation of application No. 29/509,208, filed on Nov. 14, 2014, now Pat. No. Des. 761,538, which is a continuation of application No. 14/266,599, filed on Apr. 30, 2014, now Pat. No. 9,398,786, which is a continuation of application No. 13/207,397, filed on Aug. 10, 2011, now Pat. No. 8,745,893.
- (51) **LOC (12) Cl.** ..... **02-04**
- (52) **U.S. Cl.**  
USPC ..... **D2/971**
- (58) **Field of Classification Search**  
USPC ..... D2/896, 900, 919-921, 925, 939, 947, D2/950, 969, 971; 36/1, 83, 8.1-8.3, 9 R, 36/45-58, 104, 108, 76 R

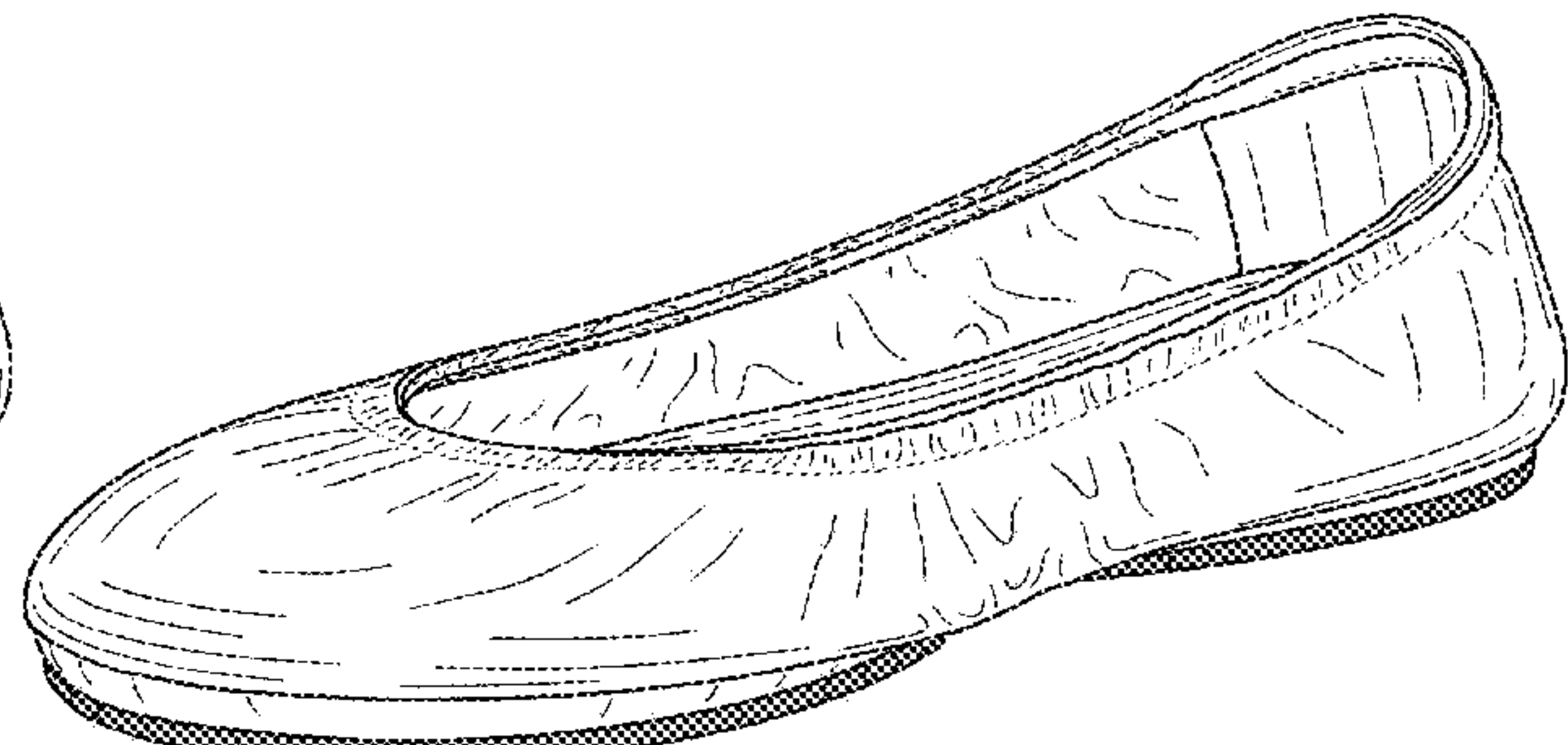
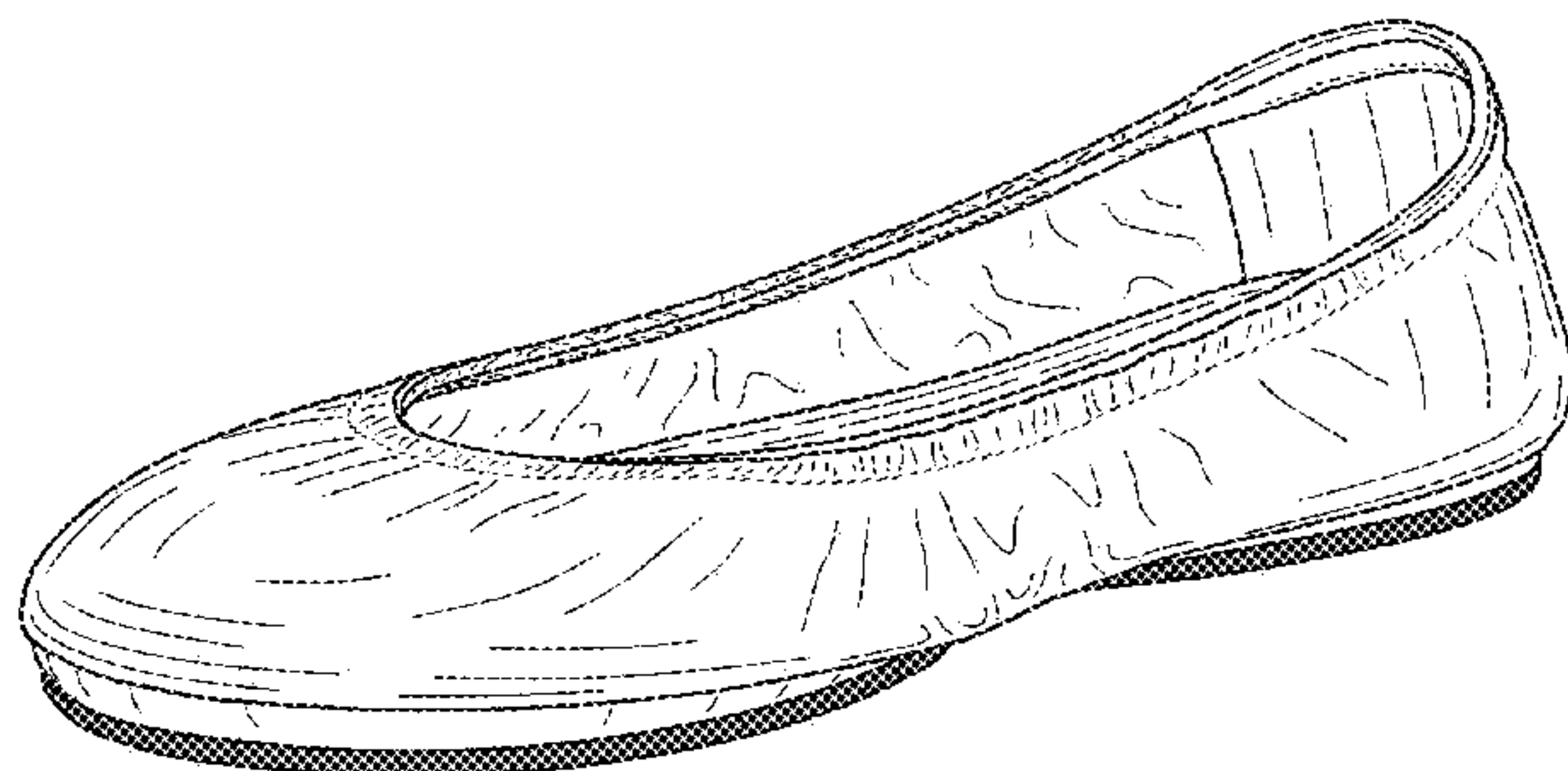



# US D886,435 S

D420,785 S	2/2000	Perez		D681,927 S *	5/2013	Gavrieli .....	A43B 13/16
6,055,745 A	5/2000	Endoh					D2/939
6,076,284 A	6/2000	Terlizzi		D681,928 S *	5/2013	Gavrieli .....	A43B 13/14
6,189,239 B1	2/2001	Gasparovic et al.					D2/939
6,338,207 B1	1/2002	Chang		D681,929 S *	5/2013	Gavrieli .....	A43B 3/24
D457,292 S *	5/2002	Sessa .....	D2/949				D2/939
D461,947 S	8/2002	Merceron		D683,936 S *	6/2013	Gavrieli .....	A43B 13/14
D476,798 S	7/2003	Reynolds et al.					D2/939
6,588,124 B2	7/2003	Morrone		8,468,723 B2	6/2013	Malka-Harari	
D498,041 S	11/2004	McClaskie		D686,812 S	7/2013	Kfir Gavrieli et al.	
D500,191 S *	12/2004	Belley .....	D2/969	8,510,975 B2	8/2013	Krikelis	
D501,706 S	2/2005	McClaskie		D688,853 S *	9/2013	Gavrieli .....	A43B 3/12
6,857,203 B2	2/2005	Minden					D2/939
6,895,693 B2	5/2005	Baruck		D688,854 S *	9/2013	Gavrieli .....	A43B 13/186
6,978,557 B2	12/2005	Lee					D2/939
7,032,327 B1	4/2006	Tartaglia et al.		D688,855 S *	9/2013	Gavrieli .....	A43B 13/16
7,036,244 B1	5/2006	Finch					D2/939
D527,513 S	9/2006	Della Valle		D689,270 S *	9/2013	Gavrieli .....	A43B 13/14
D529,513 S	10/2006	Aketa					D2/939
D531,790 S	11/2006	Wurzburg		D689,271 S *	9/2013	Gavrieli .....	A43B 3/12
D534,341 S *	1/2007	Choi .....	D2/896				D2/939
D542,513 S	5/2007	Amado et al.		D689,272 S *	9/2013	Gavrieli .....	A43B 3/108
D556,990 S	12/2007	Cabados					D2/939
7,337,558 B2	3/2008	Terlizzi et al.		D690,914 S *	10/2013	Gavrieli .....	A43B 13/186
D567,485 S	4/2008	James					D2/939
D570,488 S	6/2008	Kirksey et al.		D690,915 S *	10/2013	Gavrieli .....	A43B 3/10
D571,084 S	6/2008	Comeau					D2/939
D571,548 S	6/2008	Seamans		D696,500 S	12/2013	Hunt	
D571,989 S	7/2008	Siegal		D699,424 S	2/2014	Hamm	
D580,640 S	11/2008	Wurzburg		8,661,714 B2	3/2014	Sussman	
D582,638 S	12/2008	Ringholz		8,745,893 B2	6/2014	Gavrieli et al.	
7,496,982 B2	3/2009	Clark et al.		8,973,287 B2	3/2015	Shibata	
7,506,459 B2	3/2009	Grisoni et al.		2002/0078591 A1	6/2002	Morrone	
D591,031 S	4/2009	Cofinco		2002/0129519 A1	9/2002	Cahan	
D593,295 S *	6/2009	Belley .....	A43B 3/12	2003/0070319 A1	4/2003	Minden	
			D2/969	2003/0121176 A1	7/2003	Baruck	
D593,297 S *	6/2009	Belley .....	A43B 13/16	2004/0025377 A1	2/2004	Brannon	
			D2/969	2005/0022421 A1	2/2005	Bruckner	
D593,307 S *	6/2009	Belley .....	A43B 13/186	2005/0115115 A1	6/2005	Lacey	
			D2/969	2005/0217148 A1	10/2005	Connolly et al.	
D599,093 S *	9/2009	Issler .....	A43B 13/14	2005/0262734 A1	12/2005	Cheng	
			D2/925	2006/0086005 A1	4/2006	Yerian	
D604,030 S	11/2009	Wilson		2006/0156576 A1	7/2006	Sloan	
D607,194 S	1/2010	Zagula		2007/0074424 A1	4/2007	Lin	
D610,332 S	2/2010	Raichle		2007/0204482 A1	9/2007	Gibson-Collinson	
D610,785 S	3/2010	Smith		2007/0204483 A1	9/2007	Kirsch et al.	
D612,140 S	3/2010	Moon		2008/0052964 A1	3/2008	Taylor	
D612,141 S	3/2010	Moon		2008/0086912 A1	4/2008	Wilkenfeld	
7,694,435 B1	4/2010	Kiser et al.		2008/0110059 A1	5/2008	Kuramoto et al.	
D615,737 S	5/2010	Feller		2009/0019732 A1	1/2009	Sussmann	
7,735,244 B1	6/2010	Ameche		2009/0193685 A1	8/2009	Wilson	
7,743,530 B2	6/2010	Truelsen		2009/0205222 A1	8/2009	Mclinden	
D618,891 S	7/2010	McClaskie		2009/0272009 A1	11/2009	Weisner et al.	
7,757,408 B2	7/2010	McClaskie		2010/0011625 A1	1/2010	Percival	
D630,829 S	1/2011	Weisner		2010/0018080 A1	1/2010	Smith	
D632,881 S	2/2011	Rosenberg		2010/0050469 A1	3/2010	Chen	
7,926,203 B2	4/2011	Wilkenfeld		2010/0095557 A1	4/2010	Jarvis	
7,966,747 B2	6/2011	Wilkenfeld et al.		2010/0115793 A1	5/2010	Kraisosky	
D640,861 S	7/2011	Wilkenfeld		2010/0122475 A1	5/2010	Purrington	
8,020,320 B2	9/2011	Gillespie		2010/0146822 A1	6/2010	MacGregor	
8,127,468 B2	3/2012	Morgan		2010/0212186 A1	8/2010	Cheng	
D657,543 S	4/2012	Bove		2010/0275462 A1	11/2010	Pucci	
D659,960 S	5/2012	Bizzo		2010/0281713 A1	11/2010	Pantazes	
8,230,619 B2	7/2012	Salvatelli		2015/0089843 A1	4/2015	Gavrieli	
D664,755 S	8/2012	Gavrieli et al.					
D665,157 S	8/2012	Wu					
8,240,067 B2	8/2012	Sussmann					
8,245,420 B2	8/2012	Wilson					
D668,027 S	10/2012	Millieret					
D668,438 S	10/2012	Millieret					
D668,847 S *	10/2012	Gavrieli .....	A43B 3/12				
			D2/925				
D668,848 S *	10/2012	Gavrieli .....	A43B 3/108				
			D2/925				
D668,849 S	10/2012	Pozzi					
D668,850 S	10/2012	Pozzi					
D672,542 S	12/2012	Gray et al.					
D676,634 S *	2/2013	Gavrieli .....	A43B 13/186				
			D2/925				

## FOREIGN PATENT DOCUMENTS

DE	20	2006	000230	U1	5/2007
GB			2443937	A	5/2008
GB			2 446 205	A	8/2008
TW			D119165		10/2007

## OTHER PUBLICATIONS

Third Party Submission Under 37 CFR 1.290 regarding U.S. Appl. No. 15/905,239, filed Feb. 9, 2019, 94 pages.



- Order Granting TRO (D.I. 11), *Gavrieli Brands LLC vs. Soto Massini*, Civil Action No. 1:18-cv-00462, Mar. 28, 2018, 2 pages.
- Defendants' Opposition to Motion for Temporary Restraining Order, Civil Action No. 1:18-cv-00462-GMS, Apr. 1, 2018, 12 pages.
- Declaration of Thomas Pichler in Opposition to Tro Request, C.A. No. 1:18-cv-00462-GMS, Apr. 1, 2018, 8 pages.
- Exhibit A to Pichler Declaration ISO TRO Opposition (D.I. 13-1), C.A. No. 1:18-cv-00462-GMS, Apr. 1, 2018, 29 pages.
- Order TRO (D.I. 18), C.A. No. 1:18, Apr. 4, 2018, 3 pages.
- Defendant Soto Massini (USA) Corporation's Answer and Counterclaims to Verified Complaint for Patent Infringement, Trade Dress Infringement, and Unfair Competition, C.A. No. 1:18-cv-00462-GMS, May 1, 2018, 26 pages.
- Defendant Soto Massini (USA) Corporation's Answer to Amended Complaint and Amended Counterclaims, C.A. No. 1:18-cv-00462-GMS, Jun. 5, 2018, 28 pages.
- Defendant Soto Massini (USA) Corporation's Answer to Amended Complaint and First Amended Counterclaims, C.A. No. 1:18-cv-00462-GMS, Jul. 12, 2018, 31 pages.
- Exhibit A to SACC (45-1), Case 1:18-cv-00462-GMS, 3 pages.
- Exhibit B to SACC (45-2), Case 1:18-cv-00462-GMS, 5 pages.
- Exhibit C to SACC (45-3), Case 1:18-cv-00462-GMS, 5 pages.
- Exhibit D to SACC (45-4), Case 1:18-cv-00462-GMS, 4 pages.
- Defendant Soto—USA's Invalidity Contentions, C.A. No. 1:18-cv-00462-MN, 16 pages.
- Redacted Verdict Form (D.I. 144), Case 1:18-cv-00462-GMS, 13 pages.
- Judgement (D.I. 149), C.A. No. 18-462-MN, May 13, 2019, 3 pages.
- Gavrieli Brands, LLC, v. Soto Massini (USA) Corp., et al.*, (full) Trial Transcript, C.A. No. 18-462(MN), vol. 1, 733 pages.
- Expert Report of Caroline de Baere (Fed. R. CIV. P. 26(a)(2)(B)), Case No. 18-cv-00462-MN, Mar. 1, 2019, 33 pages.
- Exhibit 23, Infringement Analysis in Light of the Alleged Prior Art, 41 pages.
- Expert Report of Lance Rake, (Fed. R. CIV. P. 26(a)(2)(B)), Mar. 1, 2019, 27 pages.
- U.S. Pat. No. 1,525,848, Feb. 10, 1925, B. S. Bonaventure, 3 pages.
- U.S. Design Patent No. 247,396, Mar. 7, 1978, William A. Schlerth, 2 pages.
- U.S. Design Patent No. D. 611,693 S, Mar. 16, 2010, Barbara Schwartz, 7 pages.
- Camper Book Excerpt—Nina Right, (pp. 334-335), *The Walking Society*, Lars Müller Publishers, 3 pages.
- Camper History—The Shoes, Every Season We Strive to Reinvent Some of Our Classic Concepts While Continuing to Challenge the Status Quo With New and Original Designs. We Often Find That There Is a Camper Style for Every Walk of Life, 8 pages.
- Tieks by Gavrieli—Comfortable, designer flats you can fit in your purse and wear all day, every day!, Copperhead Snake Print Tieks, <https://web.archive.org/web/20101230062534/http://www.tieks.com:80/>, Dec. 30, 2010, 1 page.
- Tieks by Gavrieli—Comfortable, designer flats you can fit in your purse and wear all day, every day!, Merlot Lizard Print Tieks, <https://web.archive.org/web/20101230062534/http://www.tieks.com:80/>, Dec. 30, 2010, 1 page.
- Tieks by Gavrieli—Comfortable, designer flats you can fit in your purse and wear all day, every day!, Slate Grey Tieks, <https://web.archive.org/web/20101230062534/http://www.tieks.com:80/>, Dec. 30, 2010, 1 page.
- Tieks by Gavrieli—Comfortable, designer flats you can fit in your purse and wear all day, every day!, Camel, <https://web.archive.org/web/20101230062534/http://www.tieks.com:80/>, Dec. 30, 2010, 1 page.
- Tieks by Gavrieli—Comfortable, designer flats you can fit in your purse and wear all day, every day!, Lilac, <https://web.archive.org/web/20101230062534/http://www.tieks.com:80/>, Dec. 30, 2010, 1 page.
- Tieks by Gavrieli—Comfortable, designer flats you can fit in your purse and wear all day, every day!, Leopard Print, <https://web.archive.org/web/20101230062534/http://www.tieks.com:80/>, Dec. 30, 2010, 1 page.
- Tieks by Gavrieli—Comfortable, designer flats you can fit in your purse and wear all day, every day!, The Tieks eGift card . . . Always the perfect fit, <https://web.archive.org/web/20101230062534/http://www.tieks.com:80/>, Dec. 30, 2010, 1 page.
- Tieks by Gavrieli—Comfortable, designer flats you can fit in your purse and wear all day, every day!, Copperhead Snake Print, <https://web.archive.org/web/20110222174850/http://www.tieks.com:80/>, Feb. 22, 2011, 1 page.
- Tieks by Gavrieli—Comfortable, designer flats you can fit in your purse and wear all day, every day!, Patent Tiek Blue, <https://web.archive.org/web/20110222174850/http://www.tieks.com:80/>, Feb. 22, 2011, 1 page.
- Tieks by Gavrieli—Comfortable, designer flats you can fit in your purse and wear all day, every day!, Tangerine, <https://web.archive.org/web/20110222174850/http://www.tieks.com:80/>, Feb. 22, 2011, 1 page.
- Tieks by Gavrieli—Fashionable Flats That Fit in Your Purse California Navy, <https://web.archive.org/web/20100516173039/http://www.tieks.com:80/california-navy.html>, May 16, 2010, 1 page.
- Tieks by Gavrieli—Fashionable Flats That Fit in Your Purse Cardinal Red, <https://web.archive.org/web/20100516173045/http://www.tieks.com:80/cardinal-red.html>, May 16, 2010, 1 page.
- Tieks by Gavrieli—Fashionable Flats That Fit in Your Purse Metallic Gold, <https://web.archive.org/web/20100516173106/tieks.com/metallic-gold.html>, May 16, 2010, 1 page.
- Tieks by Gavrieli—Fashionable Flats That Fit in Your Purse Patent Tiek Blue, <https://web.archive.org/web/20100516173130/http://www.tieks.com:80/tiek-blue.html>, May 16, 2010, 1 page.
- Tieks by Gavrieli—Fashionable Flats That Fit in Your Purse Splash Page, The Ballet Flat . . . Reinvented, <https://web.archive.org/web/20100513055818/https://tieks.com/>, May 13, 2010, 1 page.
- Tieks by Gavrieli—Fashionable Flats That Fit in Your Purse Splash Page, Ballet Flats . . . with a Bonus, <https://web.archive.org/web/20100513055818/https://tieks.com/>, May 13, 2010, 1 page.
- Tieks by Gavrieli—Fashionable Flats That Fit in Your Purse Splash Page, Going Places? Take Tieks. <https://web.archive.org/web/20100513055818/https://tieks.com/>, May 13, 2010, 1 page.
- Tieks by Gavrieli—Fashionable Flats That Fit in Your Purse Splash Page, Step Into Tieks, <https://web.archive.org/web/20100513055818/https://tieks.com/>, May 13, 2010, 1 page.
- Tieks by Gavrieli—Fashionable Flats That Fit in Your Purse True Blue, <https://web.archive.org/web/20100516173135/http://www.tieks.com:80/true-blue.html>, May 16, 2010, 1 page.
- Tieks by Gavrieli—Fashionable Flats That Fit in Your Purse White Croc Print, <https://web.archive.org/web/20100516173145/http://www.tieks.com:80/white-croc-print.html>, May 16, 2010, 1 page.
- Tieks by Gavrieli—Foldable Fashionable Ballet Flats, Wild Copper, Be a little wild . . . even when you're not., <https://web.archive.org/web/20100819165503/https://tieks.com/>, Aug. 19, 2010, 1 page.
- Tieks by Gavrieli—Foldable Fashionable Ballet Flats, Paradise Blue, The perfect pair for day and night, <https://web.archive.org/web/20100819165503/https://tieks.com/>, Aug. 19, 2010, 1 page.
- Tieks by Gavrieli—Foldable Fashionable Ballet Flats, Obsidian Black, When workdays spill over into party nights., <https://web.archive.org/web/20100819165503/https://tieks.com/>, Aug. 19, 2010, 1 page.
- Tieks by Gavrieli—Foldable Fashionable Ballet Flats, Fuchsia, Sweet and sultry, <https://web.archive.org/web/20100819165503/https://tieks.com/>, Aug. 19, 2010, 1 page.
- Tieks by Gavrieli—Foldable Fashionable Ballet Flats, Tan Croc print Tieks, A timeless texture., <https://web.archive.org/web/20100819165503/https://tieks.com/>, Aug. 19, 2010, 1 page.
- Tieks by Gavrieli—Foldable Fashionable Ballet Flats, Be a little wild . . . even when you're not., <https://web.archive.org/web/20100902020755/https://tieks.com/>, Sep. 2, 2010, 1 page.
- Tieks by Gavrieli—Foldable Fashionable Ballet Flats, Obsidian Black, When workdays spill over into party nights. <https://web.archive.org/web/20100902020755/https://tieks.com/>, Sep. 2, 2010, 1 page.
- Tieks by Gavrieli—Foldable Fashionable Ballet Flats, Tan Croc Print, A timeless texture, <https://web.archive.org/web/20100902020755/https://tieks.com/>, Sep. 2, 2010, 1 page.



- Tieks by Gavrieli—Foldable Fashionable Ballet Flats, Paradise Blue, The perfect pair for day and night, <https://web.archive.org/web/20100902020755/https://tieks.com/>, Sep. 2, 2010, 1 page.
- Tieks by Gavrieli—Foldable Fashionable Ballet Flats, Fuchsia, Sweet and sultry, <https://web.archive.org/web/20100902020755/https://tieks.com/>, Sep. 2, 2010, 1 page.
- Tieks by Gavrieli—Foldable Fashionable Ballet Flats, Tiek Blue Tieks, Let yourself shine, <https://web.archive.org/web/20100902020755/https://tieks.com/>, Sep. 2, 2010, 1 page.
- Examination Report for AU 341324, 3 pgs., dated Oct. 24, 2012.
- Letter from TMI and Associates with Office Action, 2 pgs, dated Sep. 19, 2012 <http://www.payless.com/store/?&TLC=Womens&SLC=WomensNewArrivals&BLC=WomensNewArrivalsNewArrivals&With+Regular&ItemCode=60131&LotNumber=062642&Type=Adult&Popularity=637&Descriptvein>.
- Taiwanese Office Action for TW 101300726, 10 pgs., dated Sep. 6, 2012.
- “The Love List, Tieks by Gavrieli—Foldable Ballet Flats,” <http://thelovelist-carly.blogspot.com.au/2010/09/tieks-by-gavrieli-foldable-ballet.html>, 3 pgs., Sep. 12, 2010.
- “Tieks by Gavrieli,” <http://tieks.com>, 1 pg., retrieved Mar. 13, 2013 from URL.
- “Try It Mummy!, Tieks by Gavrieli,” <http://tryitmummy.blogspot.com.au/2010/12/tieks-by-gavrieli.html>, 4 pgs., Dec. 9, 2010.
- “Wearability—Real People Style, What came first, the City Flat or the Tieks,” <http://wearability.posterous.com/what-came-first-the-city-flat-or-the-tieks>, 4 pgs., Aug. 29, 2010.
- “The Ballet Flat . . . Reinvented; Ballet Flats . . . with a Bonus; Step Into Tieks; Going Places? Take Tieks,” <http://web.archive.org/web/2010052004346/http://www.tieks.com/>; 4 pgs., May 24, 2010.
- “Tieks—Comfortable designer flats you can fit in your purse and wear all day, every day,” <http://web.archive.org/web/20110731151555/http://tieks.com/>; 6 pgs., Jul. 31, 2011.
- “58th Annual Emmy Awards,” [http://spoonsforksandfashion.blogspot.com/2006\\_08\\_01\\_archive.html](http://spoonsforksandfashion.blogspot.com/2006_08_01_archive.html), depicting Nine West flats, 11 pgs., Aug. 1, 2006.
- Pictures of Nine West flats sold in 2006, 3 pgs.
- “I Love a Good Ballet Flat!,” <http://dressupfiles.com/i-love-a-good-ballet-flat>, depicting Sue London flats, 4 pgs., Sep. 3, 2010.
- Pictures of Sue London flats sold in 2010, 2 pgs.
- “Miss Cathie Reviews: The Yosi Samra Foldable Ballet Flat . . .,” <http://www.misscathie.com/2010/01/miss-cathie-reviews-the-yosi-samra-foldable-ballet-flat/>, depicting Yosi Samra flats, 7 pgs., Jan. 2010.
- Pictures of Yosi Samra flats sold in 2010, 2 pgs.
- “Goodbye two thousand ten,” [http://emmajoyrussell.blogspot.com/2010\\_12\\_01\\_archive.html](http://emmajoyrussell.blogspot.com/2010_12_01_archive.html), depicting Gap flats, 39 pgs., Dec. 1, 2010.
- Pictures of Gap flats available for sale in 2010, 9 pgs.
- “Our newest design of folding flats-Pink,” <https://fitinclouds.wordpress.com/2010/05/16/our-newest-design-of-folding-flats-pink/>, depicting Fit in Clouds flats, 1 pg., May 16, 2010.
- “Fit in Clouds Satin Folding Shoes,” <http://www.goodhousekeeping.com/product-reviews/clothing/best-ballet-flats/fit-in-clouds-satin-foldable-ballet-flats>, depicting Fit in Clouds flats, 1 pg., Aug. 2013.
- Pictures of Fit in Clouds flats available for sale in 2011, 4 pgs.
- “Shoes for Standing,” <https://truthinshoes.wordpress.com/2008/07/>, depicting Sam & Libby flats, 2 pgs., Jul. 31, 2008.
- “Target Designer Collaboration: Announcing Sam & Libby Shoes for Target,” <http://www.therecessionista.com/2012/11/target-designer-collaboration-announcing-sam-libby-shoes-for-target.html>, depicting Sam & Libby flats, 1 pg., Nov. 26, 2012.
- Pictures of Sam & Libby flats available for purchase in 2011, 5 pgs.
- “Save your soles with Citisoles ballet flats,” <http://glamazondiaries.com/2009/07/save-your-soles-with-citisoles-ballet-flats>, depicting Citisoles flats, 3 pgs., Jul. 2009.
- Pictures of Citisoles flats available for purchase in 2009, 3 pgs.
- “#16 Corso Como Delicious Pumps Review and Giveaway!,” <http://www.mommatoldmeblog.com/2011/01/16-corso-como-delicious-pumps-review.html>, depicting Corso Como flats, 8 pgs., Jan. 16, 2011.
- Pictures of Corso Como flats available for sale in 2011, 3 pgs.
- “jil-sander-navy-lead-ballet-flats-product . . .,” [www.ebay.com](http://www.ebay.com), depicting Jil Sander flats, 4 pgs., Nov. 2013.
- Pictures of Jil Sander flats available for sale in 2011, 3 pgs.
- “Spare Soles: Shoes That Roll-up & Fold-up,” <http://herpackinglist.com/2011/01/spare-soles-shoes/>, depicting Spare Soles flats, 2 pgs., Jan. 2011.
- Pictures of Spare Soles flats available for sale in 2011, 5 pgs.
- The Original Rollable, Foldable ballet flats with matching wristlet—Spare Soles, <http://herpackinglist.com/2011/01/spare-soles-shoes/>, depicting Roll-Upz Spare Soles flats, 2 pgs., Jan. 2011.
- Pictures of Roll-Upz by Spare Soles flats available for sale in 2011, 6 pgs.
- “The Cutest Blog, Preppy 50 and Loving Lilly, Ballet Flat Delight,” <http://preppy50andlovinglilly.blogspot.com/2011/02/ballet-flat-delight.html>, depicting Henri Bendel flats, 13 pgs., Feb. 19, 2011.
- Pictures of Henri Bendel flats available for sale in 2011, 4 pgs.
- “Mumsnet by parents for parents,” [http://www.mumsnet.com/Talk/style\\_and\\_beauty/a1612000-Anyone-tried-Redfoot-Flatmates-foldable-ballet-pumps](http://www.mumsnet.com/Talk/style_and_beauty/a1612000-Anyone-tried-Redfoot-Flatmates-foldable-ballet-pumps), depicting Redfoot Flatmates flats, 1 pg., Nov. 14, 2012.
- Pictures of Redfoot Flatmates flats available for sale in 2011, 6 pgs.
- “Amazon.com: Customer Reviews: Bloch London Women’s Lux Ballet Flat,” <http://www.amazon.com/Bloch-London-Womens-Ballet-Flat/product-reviews/B004LWP7YW>, depicting Bloch London flats, 4 pgs., Dec. 11, 2011.
- Pictures of Bloch London flats offered for sale in 2011, 11 pgs.
- “H&m foldable leopard print flat,” <http://845shops.wordpress.com/2011/06/16/flats-for-7-bucks/shoe1/>, depicting h&m flats, 3 pgs., Jun. 16, 2011.
- Pictures of h&m foldable flats offered for sale in 2011, 4 pgs.
- “Seekyt—Juicy Couture Ballet Flats—Are They Worth the Money?,” <http://seekyt.com/juicy-couture-ballet-flats-are-they-worth-the-money/>, 14 pgs., Jun. 3, 2011.
- Pictures of Juicy Couture flats offered for sale in 2011, 3 pgs.
- “Purse Flats,” <http://purseflats.wordpress.com>, depicting Purse Flats by Erica Wilson, 3 pgs., Jul. 12, 2012.
- Pictures of Purse Flats by Erica Wilson offered for sale in 2011, 6 pgs.
- “Splash Page,” <http://web.archive.org/web/20100524004346/http://www.tieks.com/>, 4 pgs., May 24, 2010.
- “Tieks by Gavrieli—Comfortable, designer flats you can fit in your purse and wear all day . . .,” <http://web.archive.org/web/20110202210649/http://www.tieks.com/>, 8 pgs., Feb. 2, 2011.
- “Carolina M. M. Gonzalez > Tieks by Gavrieli,” [http://m2.facebook.com/Tieks?v=timeline&filter=2&timecutoff=1406427986&page=17&sectionLoadingID=m\\_timeline\\_loading\\_div\\_1293868799\\_1262332800\\_8\\_17&timeend=1293868799&timestart=1262332800&tm=AQDOvqhWQPN\\_Nbwm&refid=17](http://m2.facebook.com/Tieks?v=timeline&filter=2&timecutoff=1406427986&page=17&sectionLoadingID=m_timeline_loading_div_1293868799_1262332800_8_17&timeend=1293868799&timestart=1262332800&tm=AQDOvqhWQPN_Nbwm&refid=17), 1 pg. Jan 26. 2010.
- “The Shoes Oprah Would Wear to Work (if She Had to Walk),” <http://www.inc.com/30under30/christina-desmarais/kfir-gavrieli-and-elram-gavrieli-founders-of-tieks.html>, 8 pgs., Jul. 2, 2012.
- “Tieks by Gavrieli,” [http://m2.facebook.com/Tieks?v=timeline&filter=2&timecutoff=1406427986&page=14&sectionLoadingID=m\\_timeline\\_loading\\_div\\_1293868799\\_1262332800\\_8\\_14&timeend=1293868799&timestart=1262332800&tm=AQDOvqhWQPN\\_Nbwm&refid=17](http://m2.facebook.com/Tieks?v=timeline&filter=2&timecutoff=1406427986&page=14&sectionLoadingID=m_timeline_loading_div_1293868799_1262332800_8_14&timeend=1293868799&timestart=1262332800&tm=AQDOvqhWQPN_Nbwm&refid=17), 4 pgs., Jan. 26, 2010.
- “Mighty Life List, Sensible Shoes,” <http://mightygirl.com/2010/08/24/sensible-shoes/>, 10 pgs., Aug. 24, 2010.
- “Find! Tieks: Fab & sexy flats for fall,” <http://thefabmom.com/2013/08/29/find-tieks-fab-sexy-flats-for-fall/>, 3 pgs. Aug. 29, 2013.
- “Step into Tieks,” <http://sliceofpink.typepad.com/blog/2010/09/tieks-1.html>, 5 pgs., Sep. 22, 2010.
- “In Need of Flat-Soled Shoes,” <http://sliceofpink.typepad.com/blog/2010/09/tieks-1.html>, 7 pgs., Oct. 3, 2010.
- “Say Hello to the Flat Shoes You Need for Fall . . . All 88 of Them!”, Picture of Adam Tucker Shoe/Slipper, <https://www.facebook.com/search/top?q=adam%20shoes%20slipper>, last accessed Oct. 28, 2016, dated Oct. 1, 2013, 1 page.
- Picture of Adam Tucker Rainbow Shoes, <https://www.facebook.com/search/top?q=adam%20shoes%20rainbow>, last accessed Oct. 28, 2016, dated Aug. 14, 2013, 1 page.



*Primary Examiner* — Dominic V Simone  
*(74) Attorney, Agent, or Firm* — Morgan, Lewis &  
Bockius LLP

(57) **CLAIM**

The ornamental design for a shoe with dual outpatch sole, as shown and described.

**DESCRIPTION**

The file of this patent contains at least one drawing executed in color. Copies of this patent with color drawing(s) will be provided by the Office upon request and payment of the necessary fee.

FIG. 1 is a perspective view of an embodiment of our new design of a shoe with dual outpatch sole wherein the dual outpatch sole has been colored green;

FIG. 2 is a first side view of the design of FIG. 1;

FIG. 3 is a second side view of the design of FIG. 1;

FIG. 4 is a top view of the design of FIG. 1;

FIG. 5 is a bottom view of the design of FIG. 1;

FIG. 6 is a front view of the design of FIG. 1;

FIG. 7 is a back view of the design of FIG. 1;

FIG. 8 is a perspective view of another embodiment of our new design of a shoe with dual outpatch sole wherein the dual outpatch sole has been colored orange;

FIG. 9 is a first side view of the design of FIG. 8;

FIG. 10 is a second side view of the design of FIG. 8;

FIG. 11 is a top view of the design of FIG. 8;

FIG. 12 is a bottom view of the design of FIG. 8;

FIG. 13 is a front view of the design of FIG. 8;

FIG. 14 is a back view of the design of FIG. 8;

FIG. 15 is a perspective view of another embodiment of our new design of a shoe with dual outpatch sole wherein the dual outpatch sole has been colored purple;

FIG. 16 is a first side view of the design of FIG. 15;

FIG. 17 is a second side view of the design of FIG. 15;

FIG. 18 is a top view of the design of FIG. 15;

FIG. 19 is a bottom view of the design of FIG. 15;

FIG. 20 is a front view of the design of FIG. 15;

FIG. 21 is a back view of the design of FIG. 15;

FIG. 22 is a perspective view of another embodiment of our new design of a shoe with dual outpatch sole wherein the dual outpatch sole has been colored red;

FIG. 23 is a first side view of the design of FIG. 22;

FIG. 24 is a second side view of the design of FIG. 22;

FIG. 25 is a top view of the design of FIG. 22;

FIG. 26 is a bottom view of the design of FIG. 22;

FIG. 27 is a front view of the design of FIG. 22;

FIG. 28 is a back view of the design of FIG. 22;

FIG. 29 is a perspective view of another embodiment of our new design of a shoe with dual outpatch sole wherein the dual outpatch sole has been colored yellow;

FIG. 30 is a first side view of the design of FIG. 29;

FIG. 31 is a second side view of the design of FIG. 29;

FIG. 32 is a top view of the design of FIG. 29;

FIG. 33 is a bottom view of the design of FIG. 29;

FIG. 34 is a front view of the design of FIG. 29; and,

FIG. 35 is a back view of the design of FIG. 29.

The broken lines showing elements in the above described Figures are for illustrative purposes only and form no part of the claimed design.

**1 Claim, 30 Drawing Sheets**  
**(25 of 30 Drawing Sheet(s) Filed in Color)**

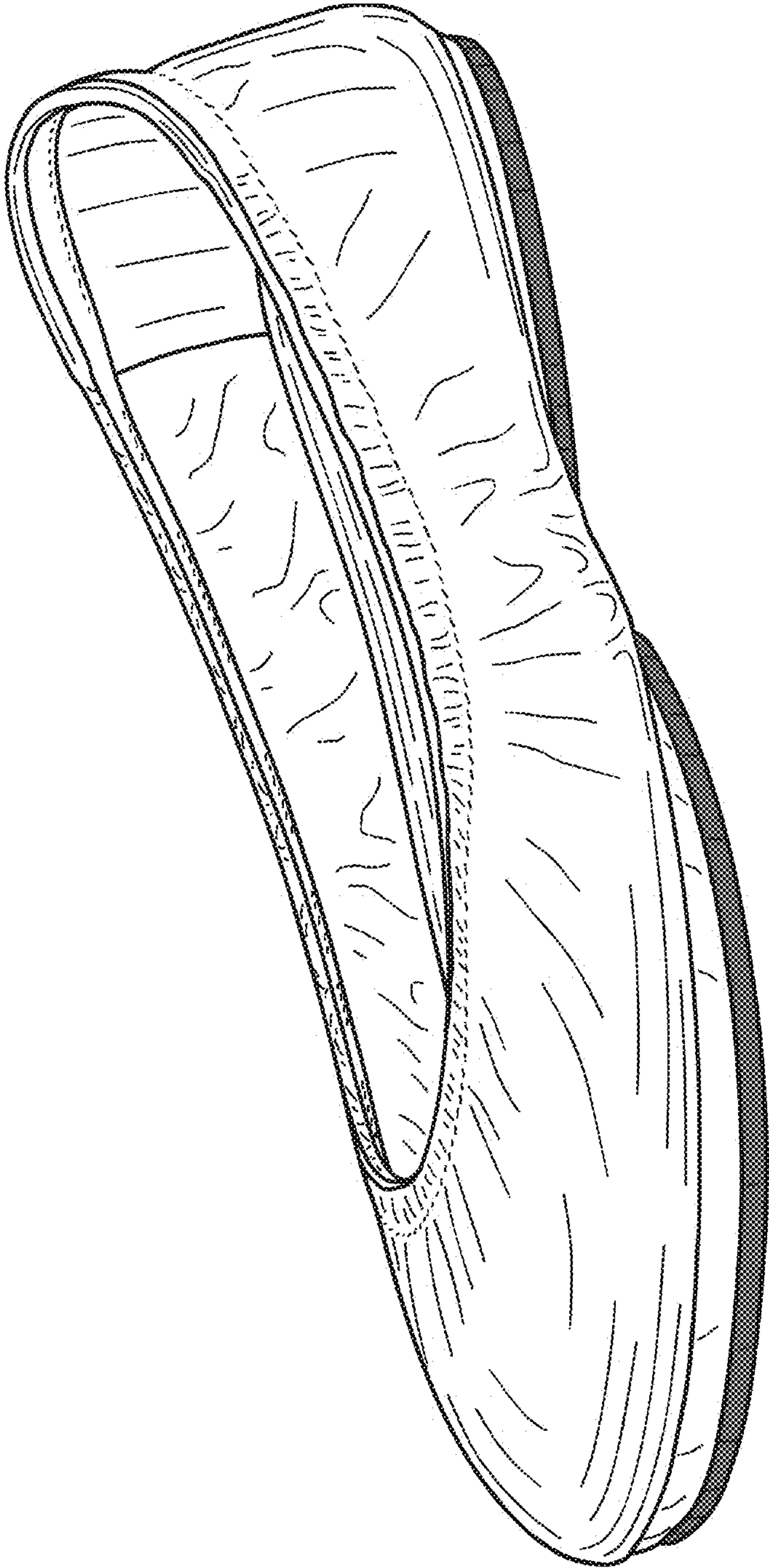

FIG. 1

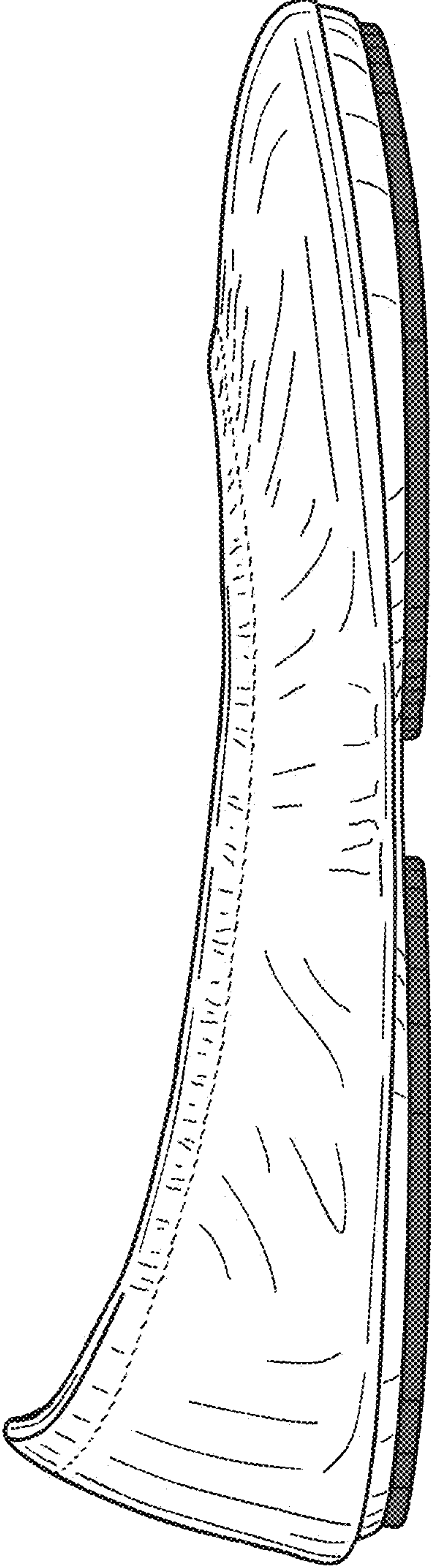

FIG. 2

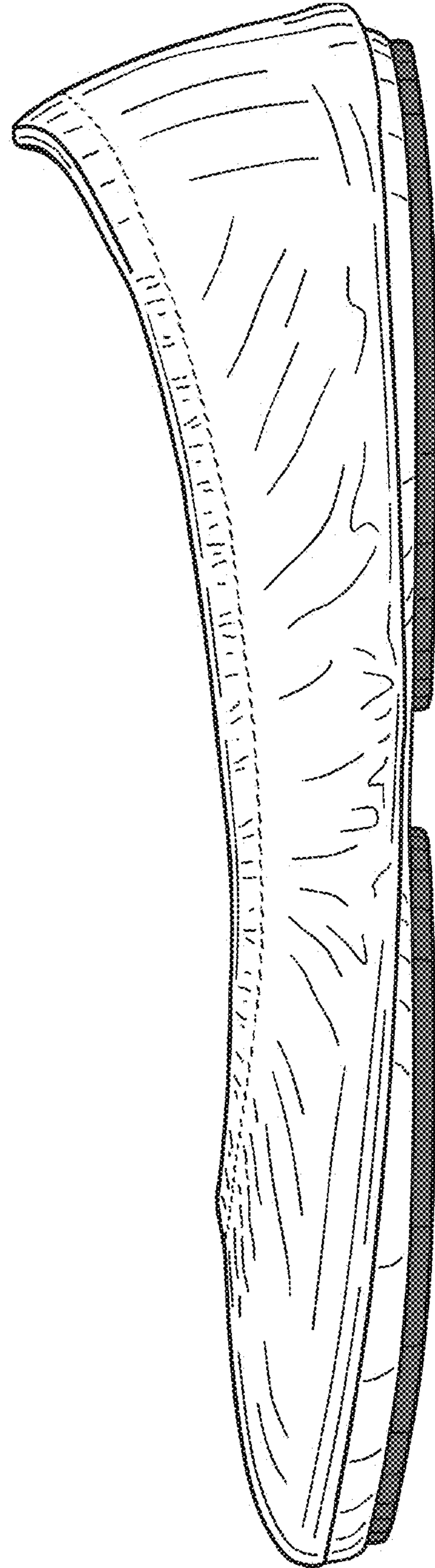

FIG. 3



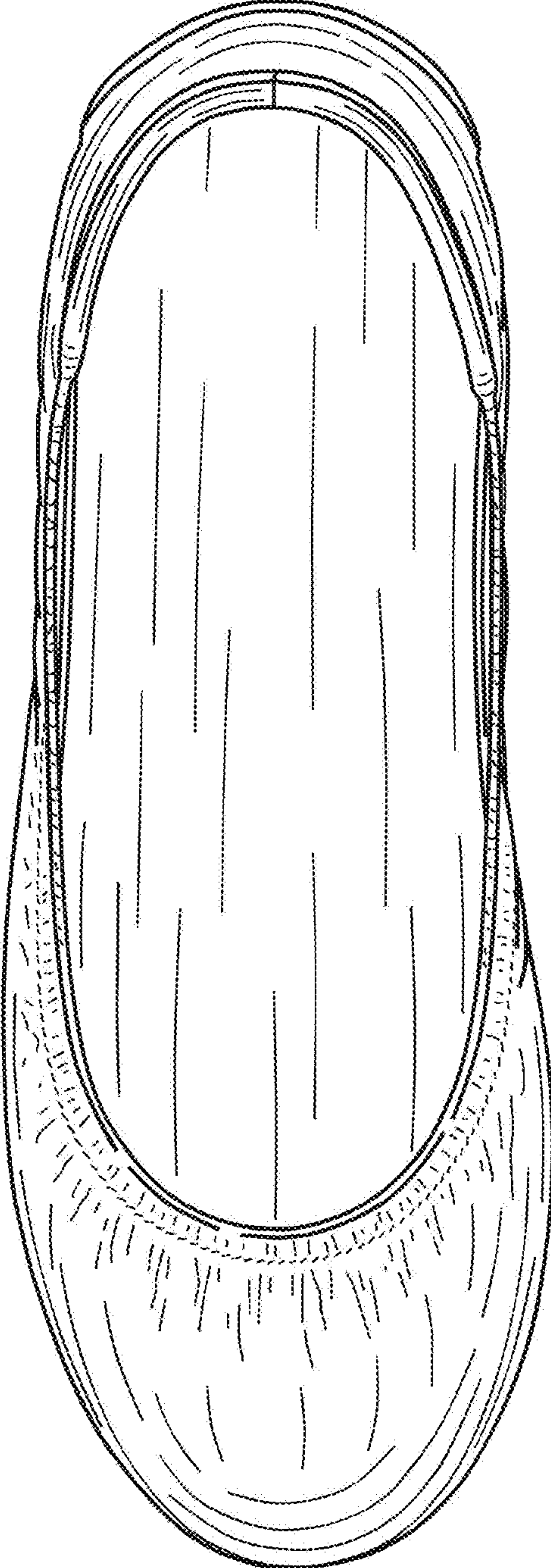

FIG. 4

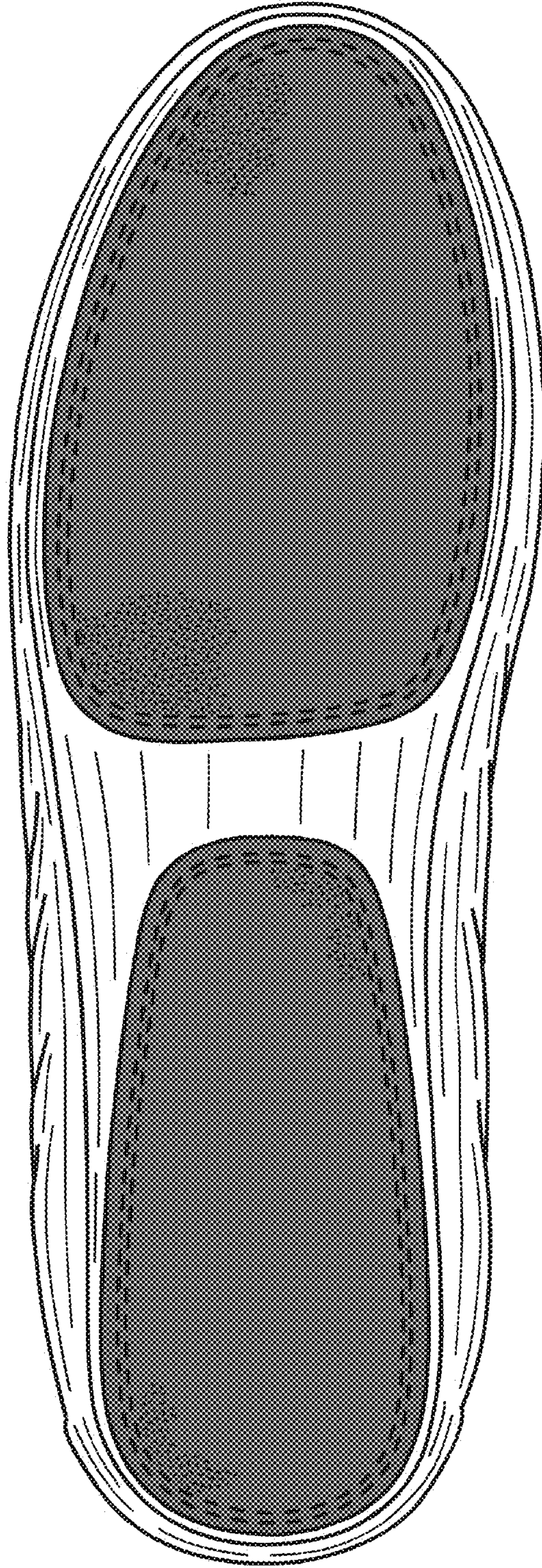

FIG. 5



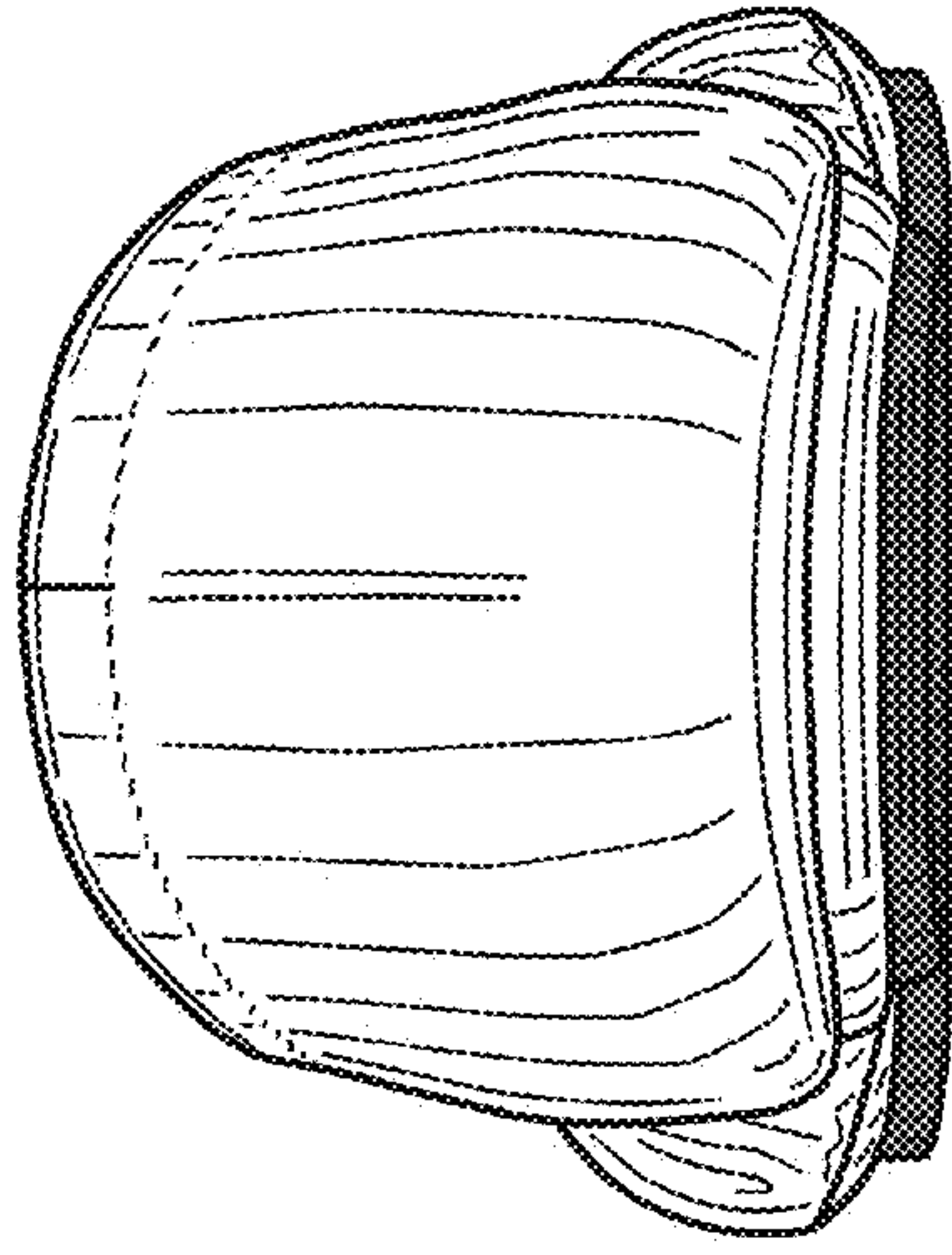

FIG. 7

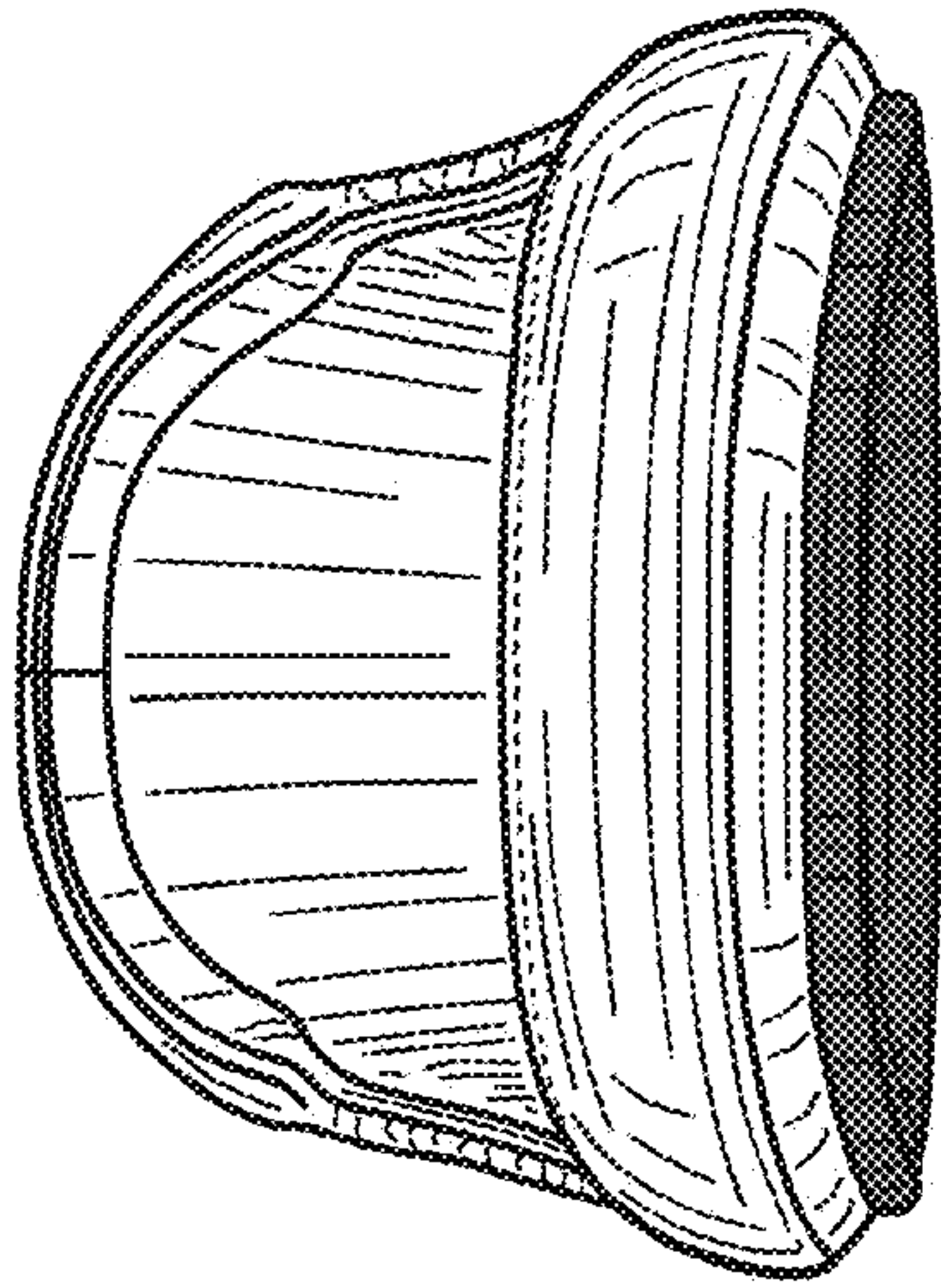

FIG. 6

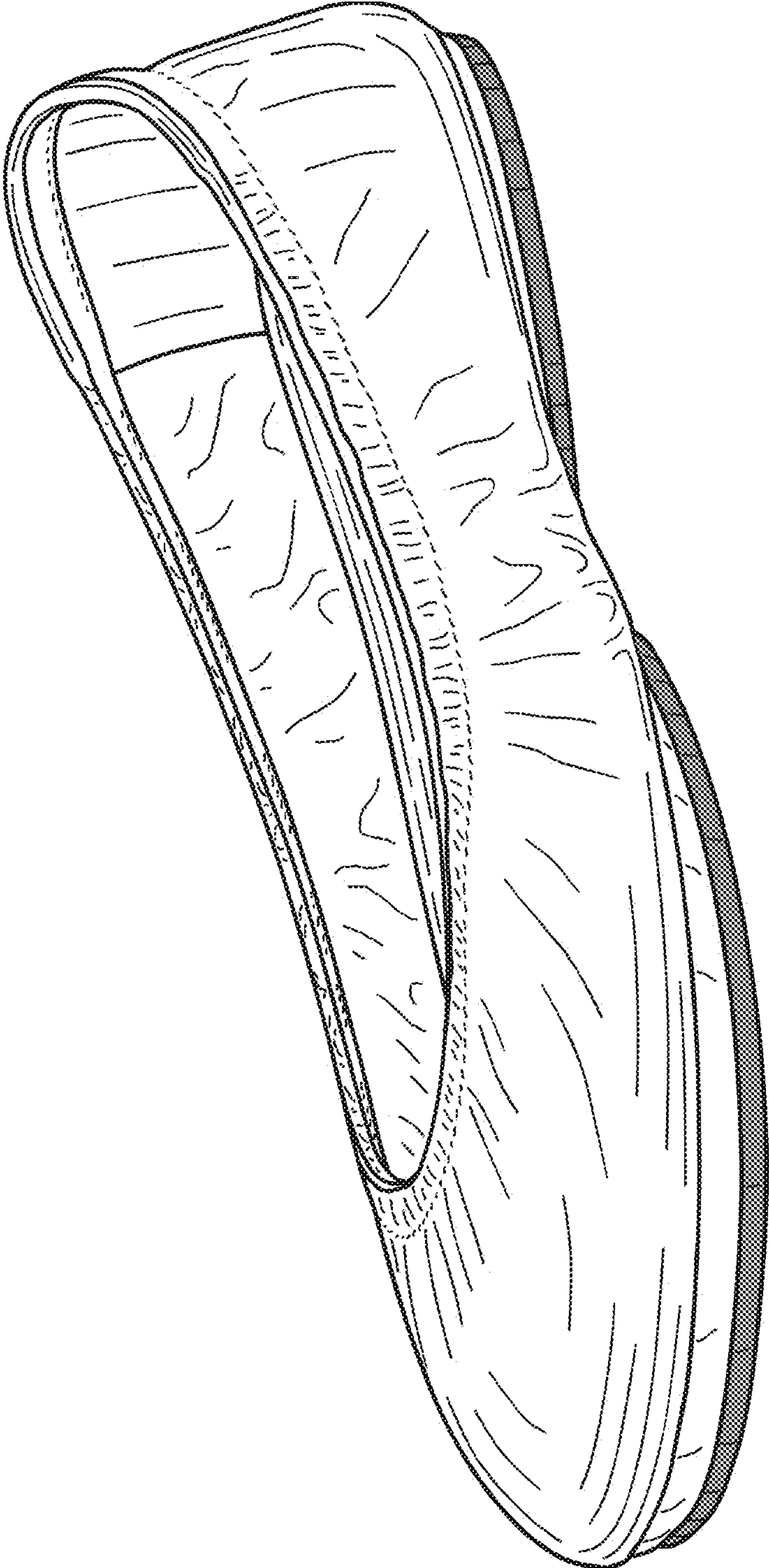

FIG. 8



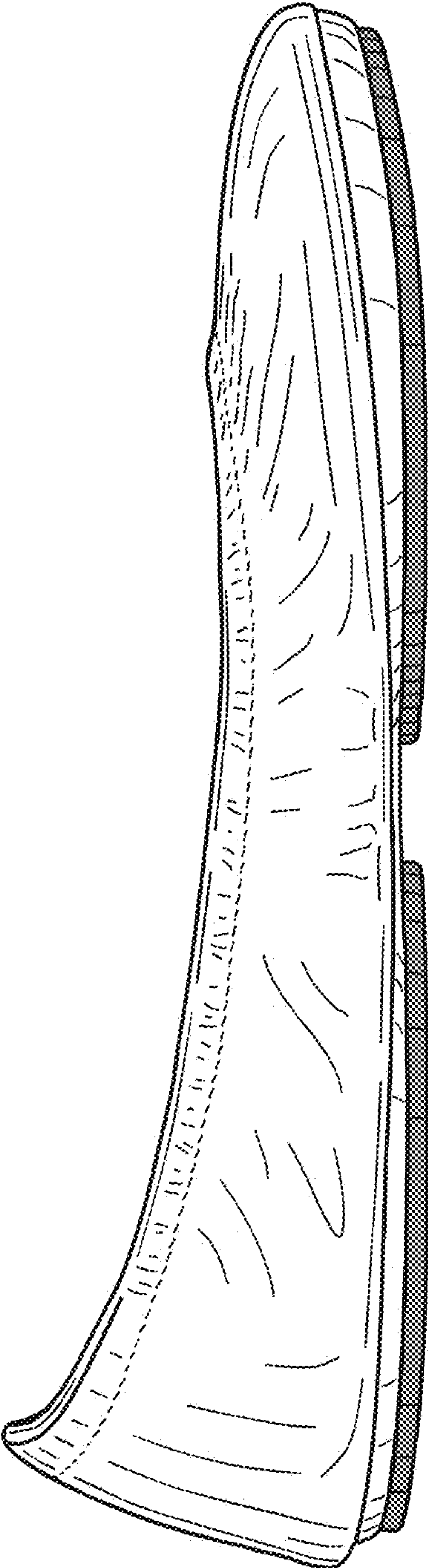

FIG. 9

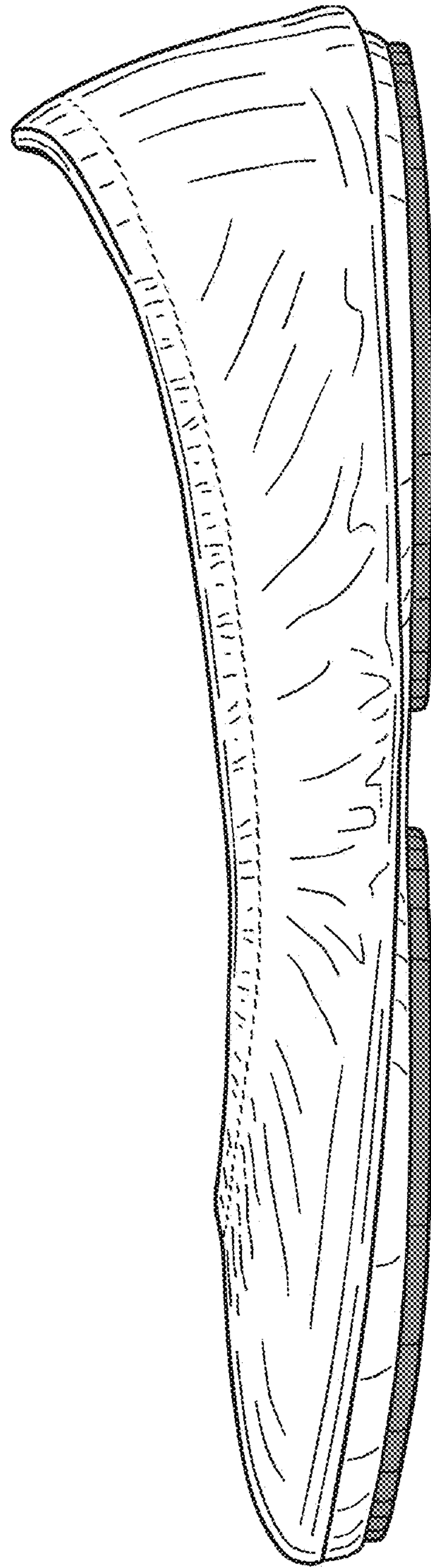

FIG. 10



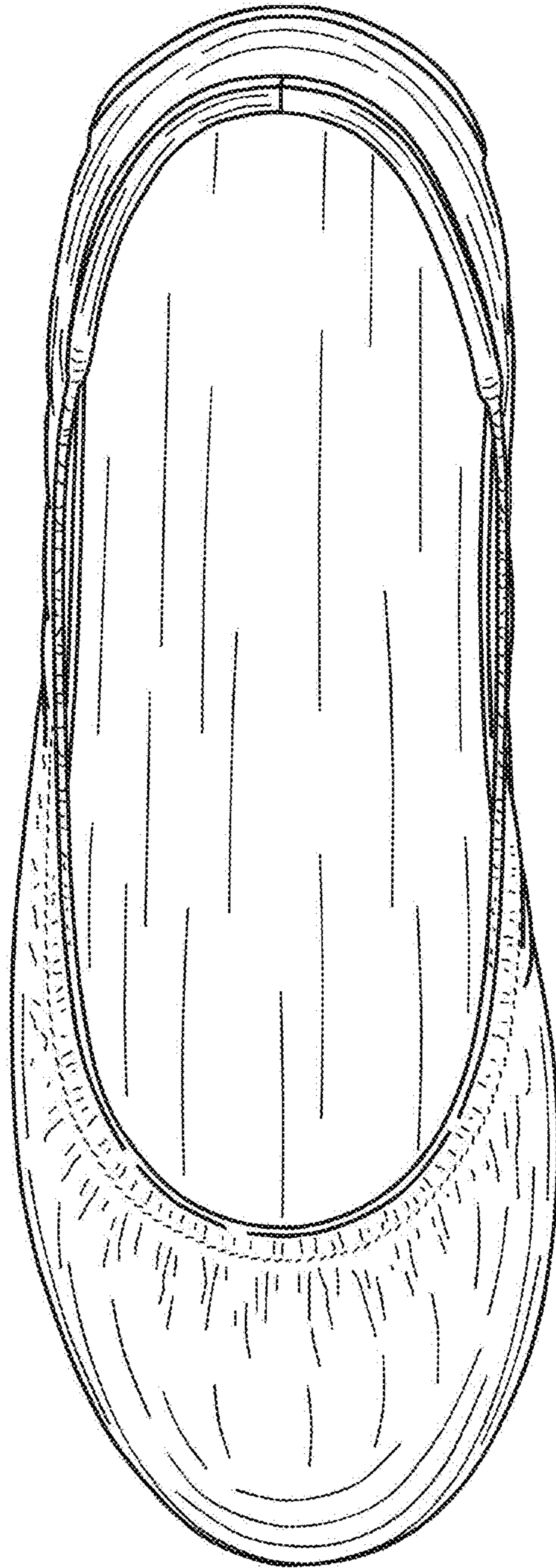

FIG. 11

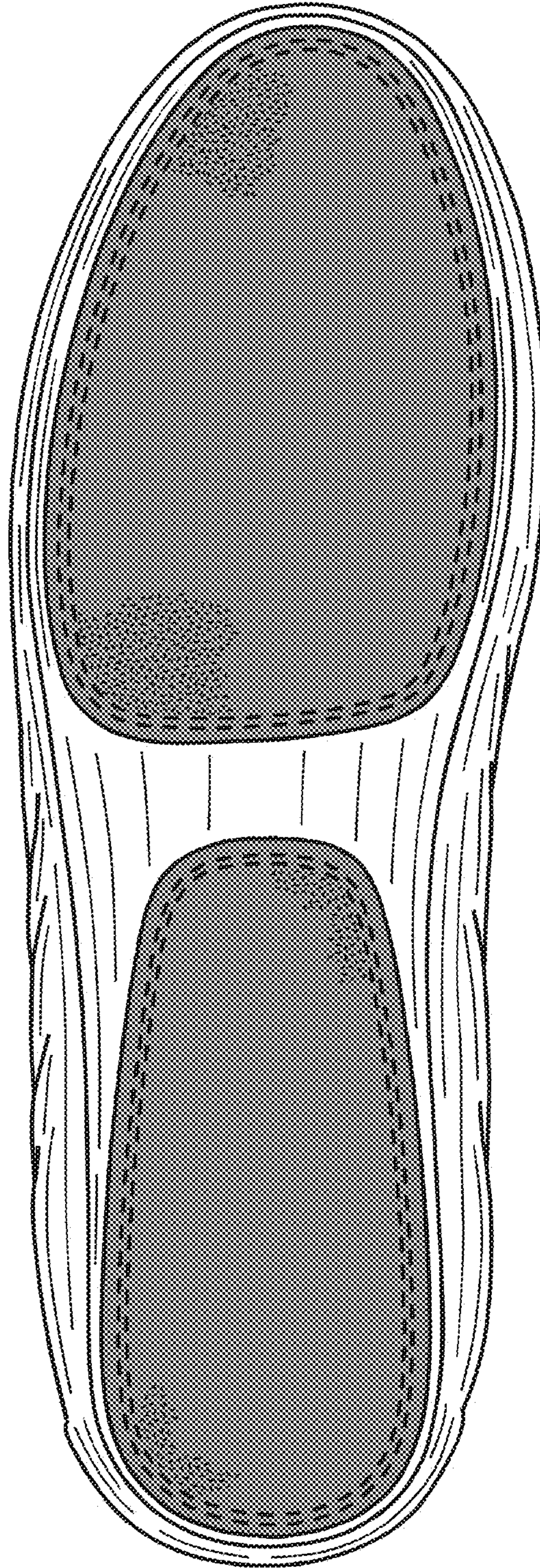

FIG. 12



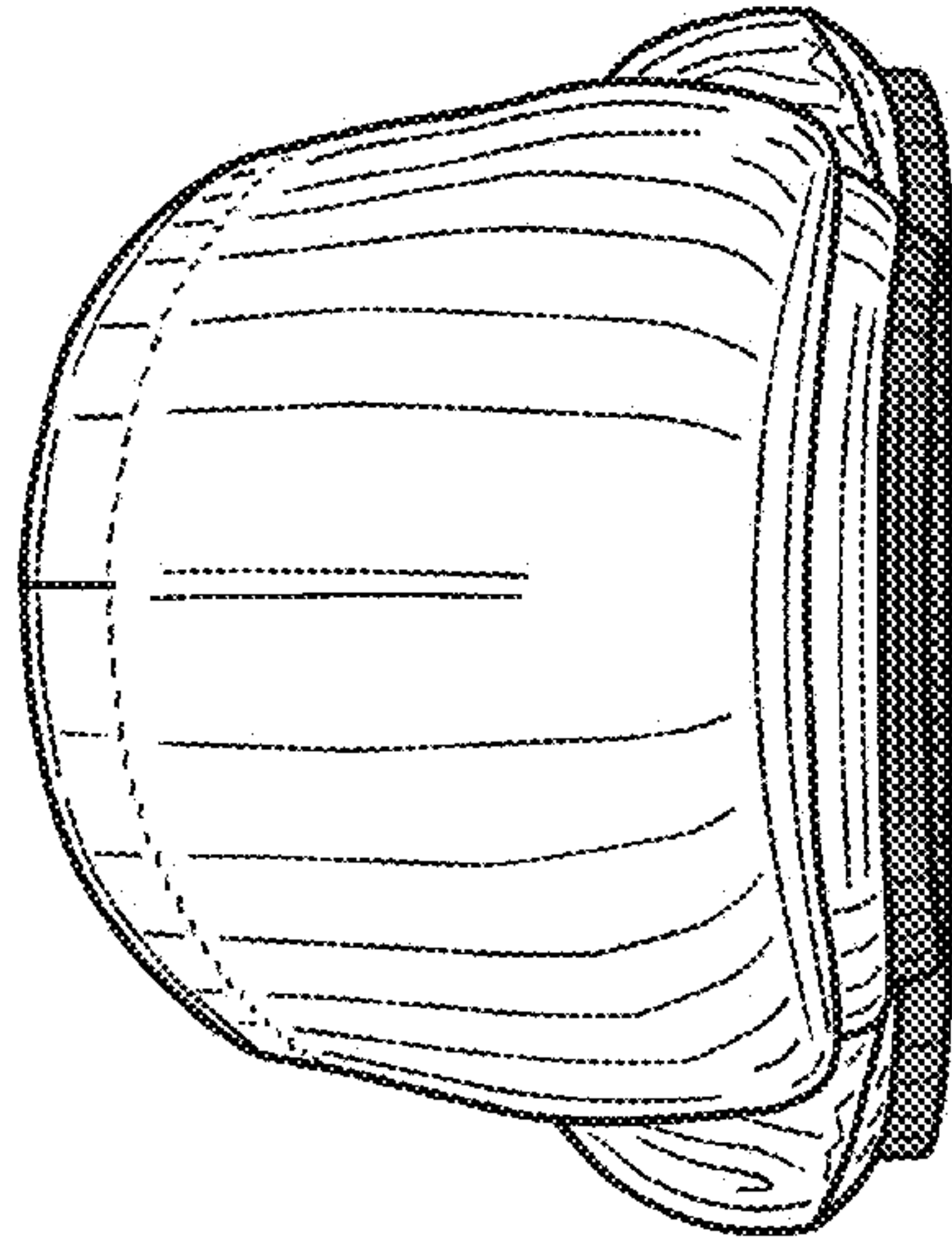

FIG. 14

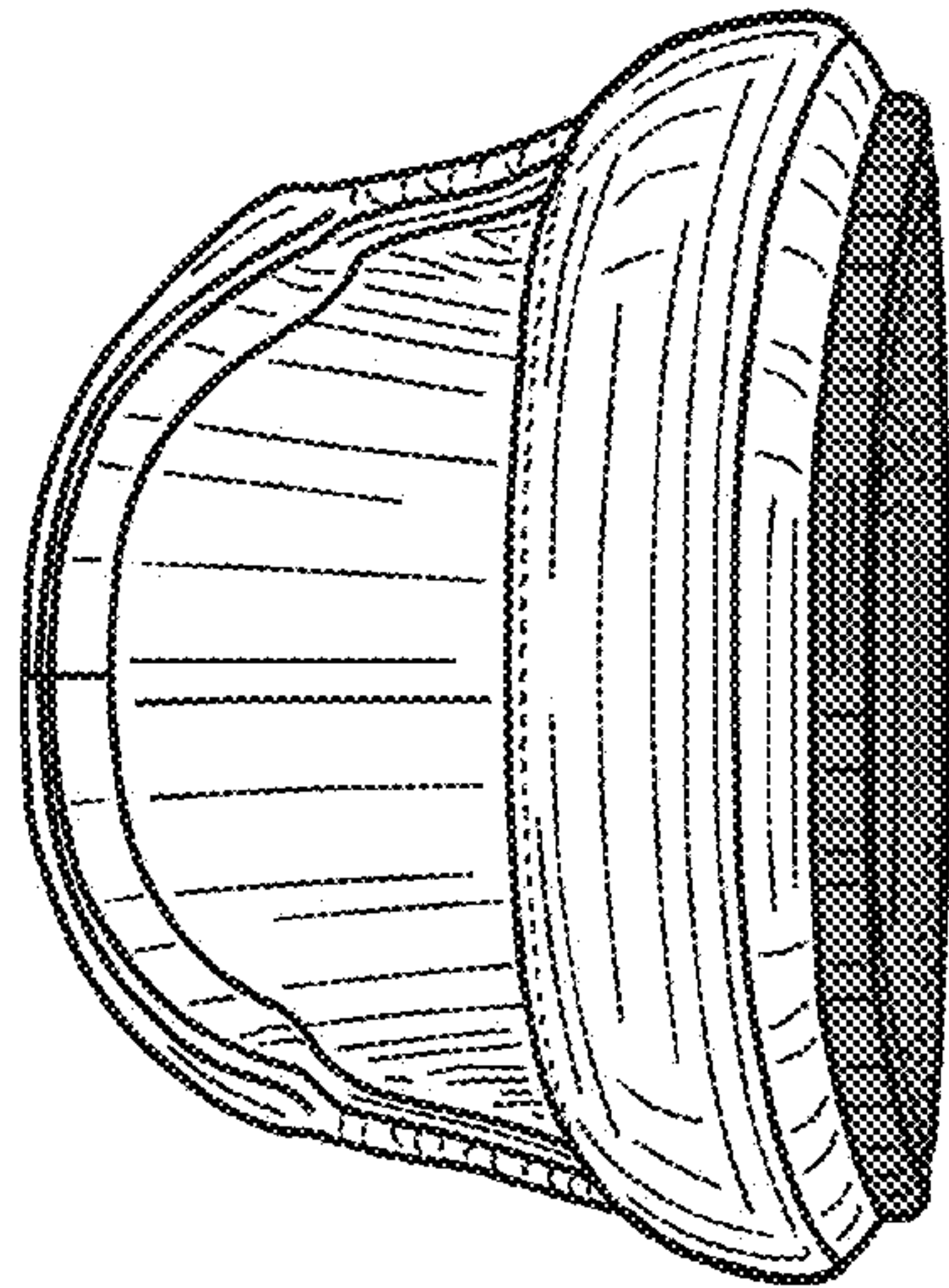

FIG. 13

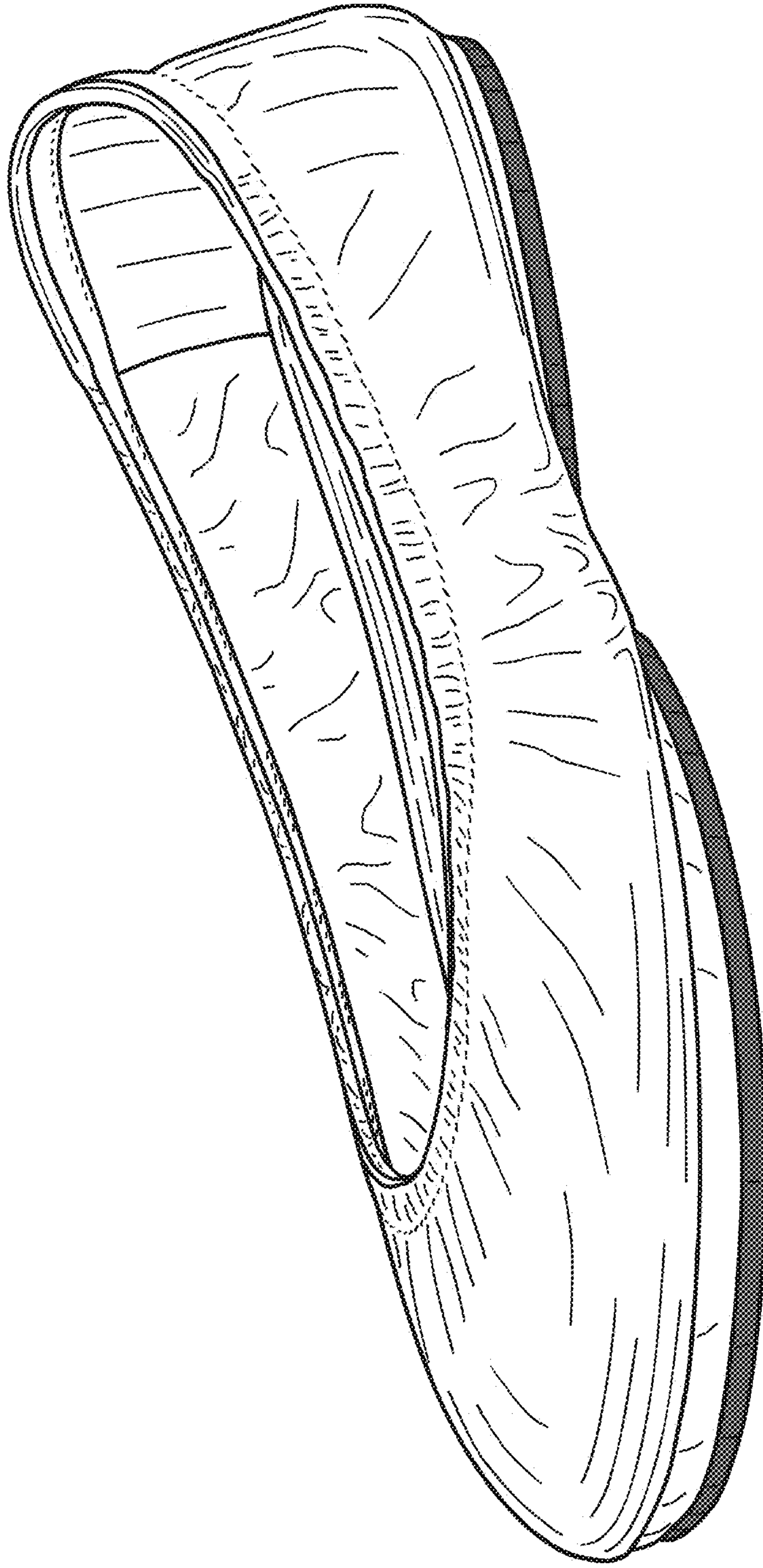

FIG. 15



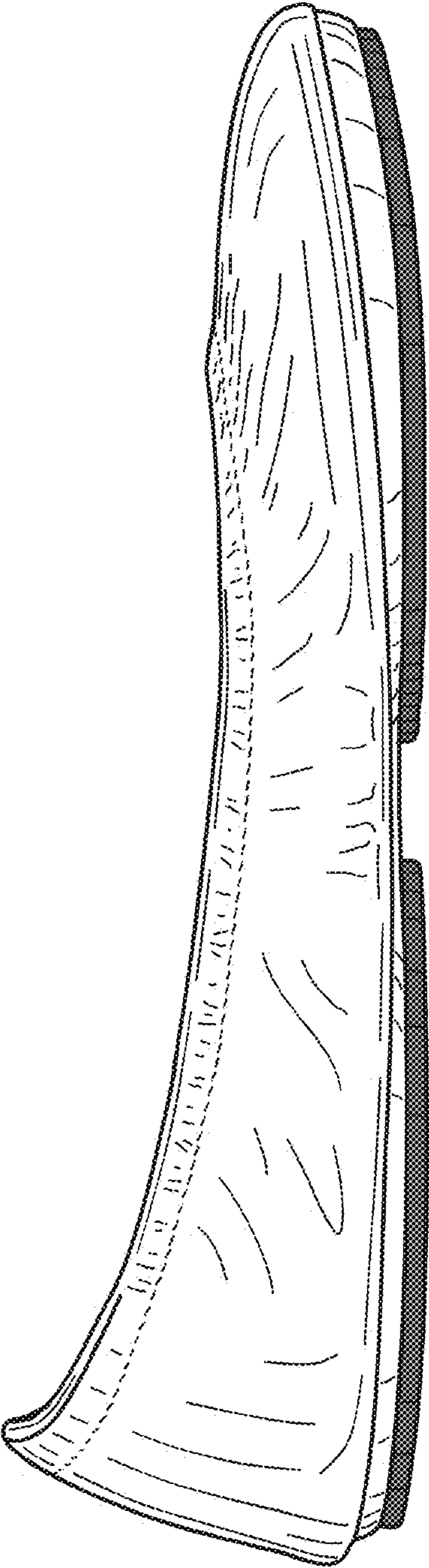

FIG. 16

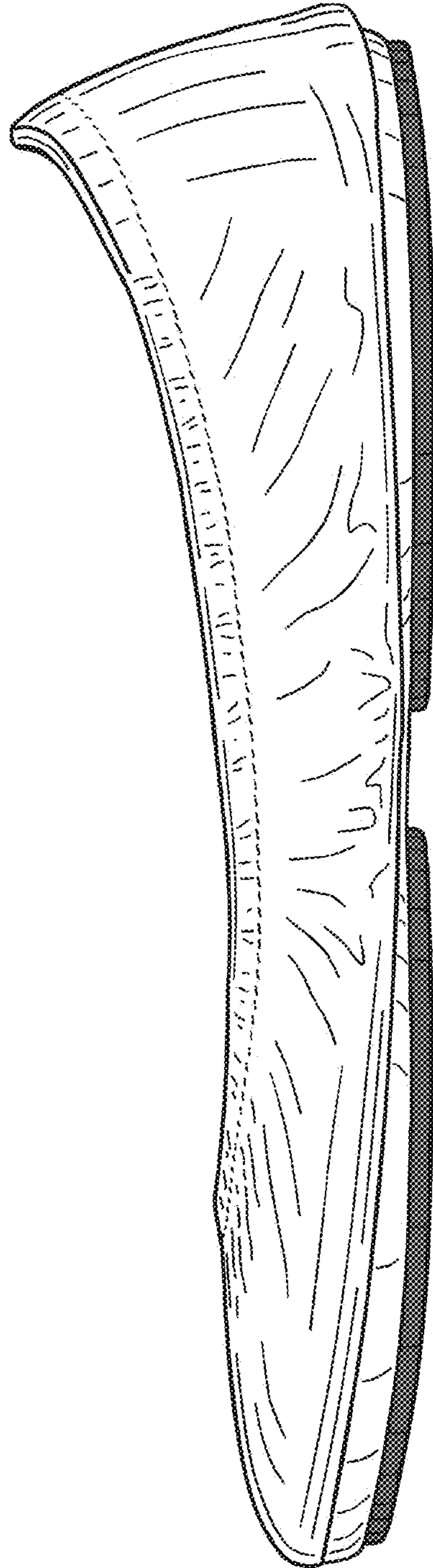

FIG. 17



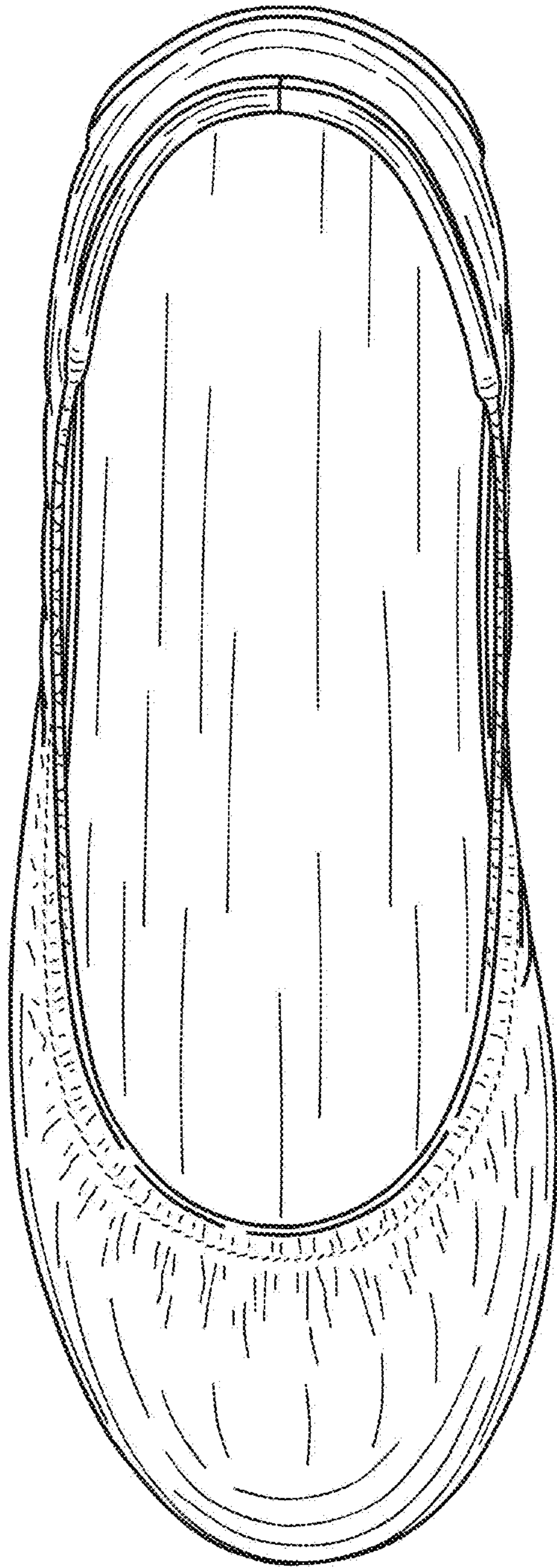

FIG. 18

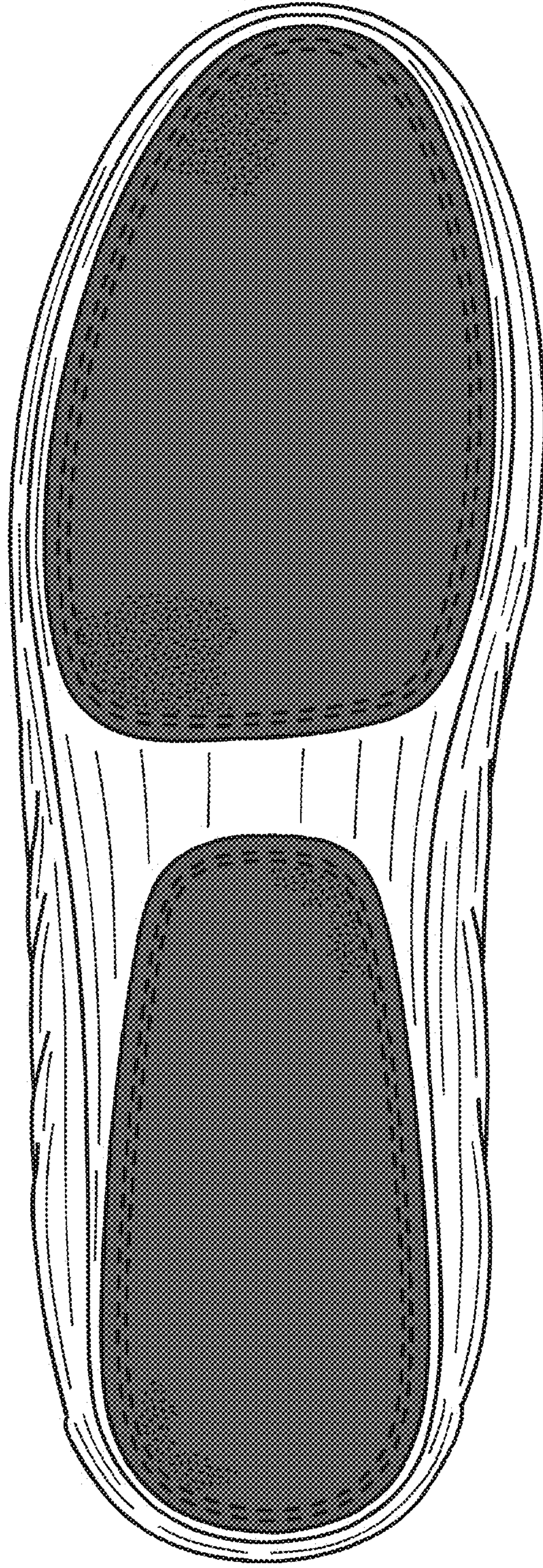

FIG. 19



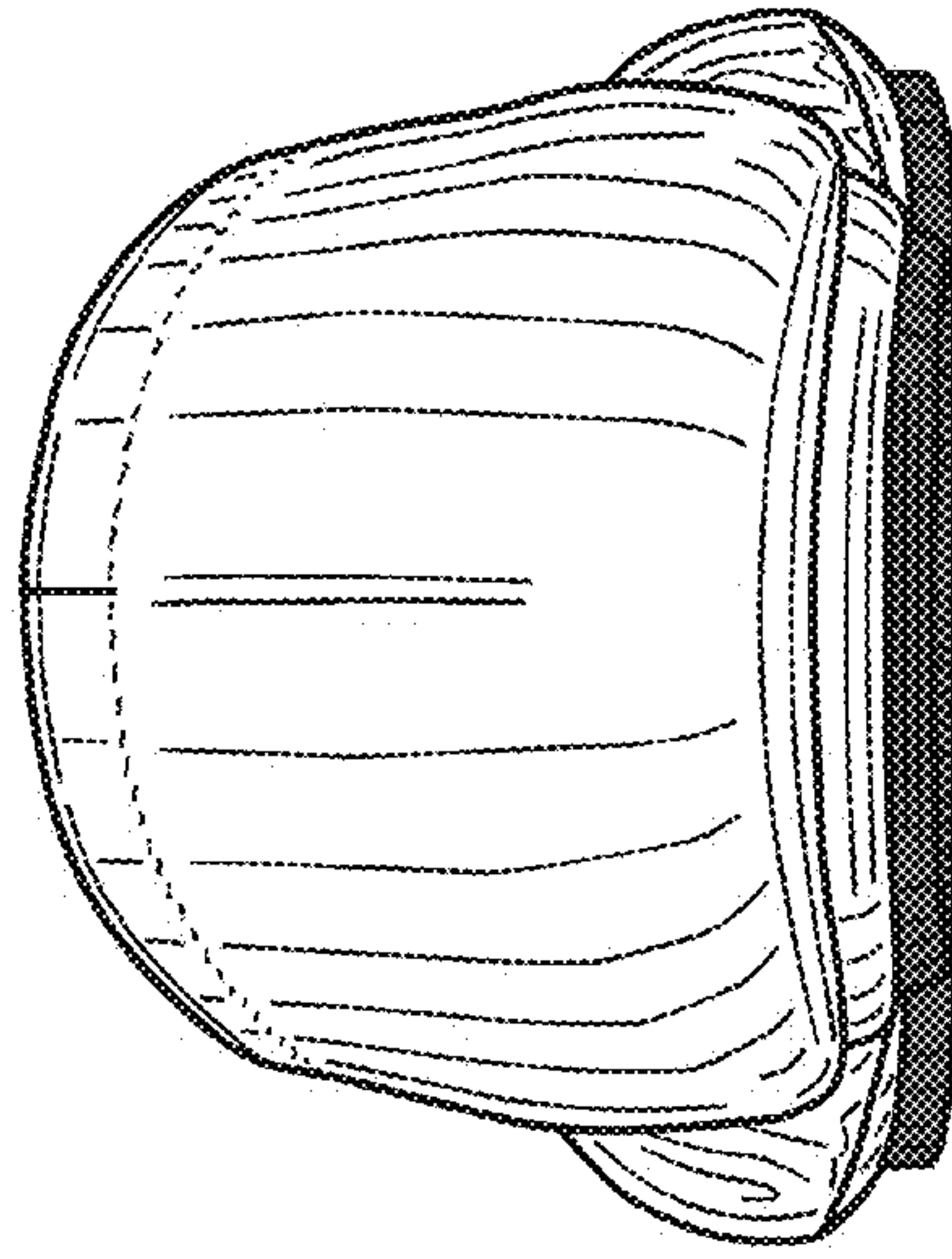

FIG. 21

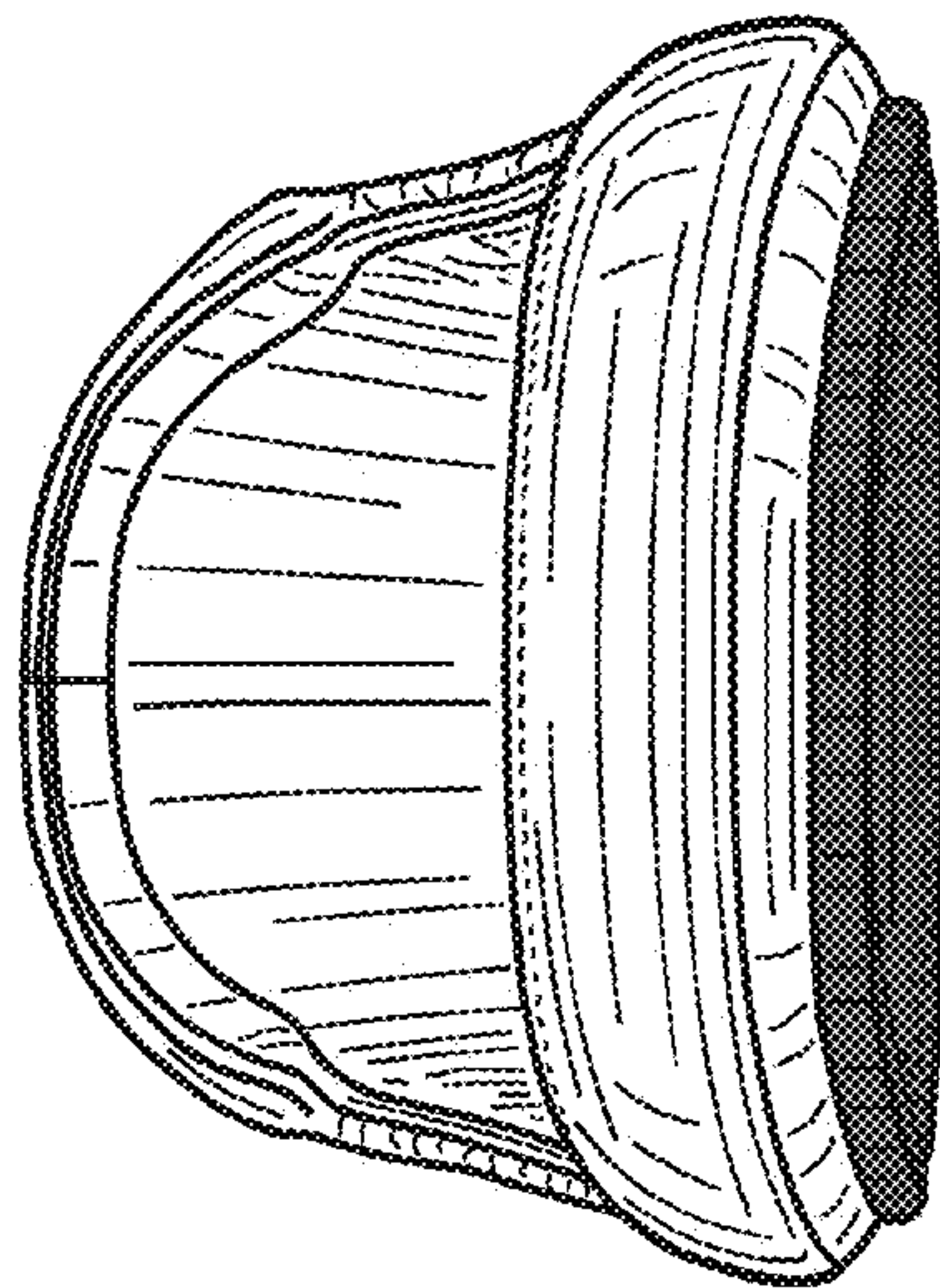

FIG. 20

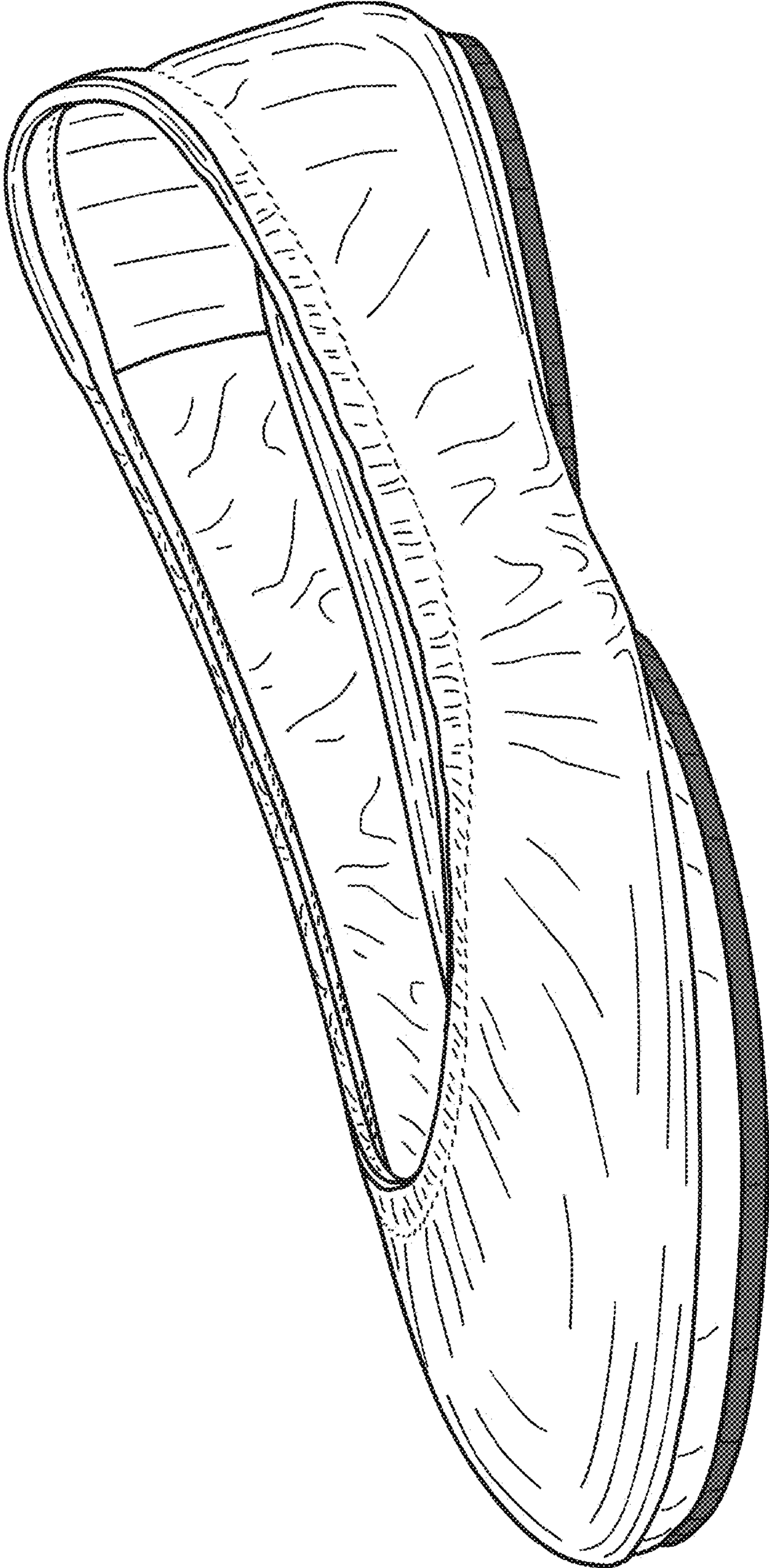

FIG. 22



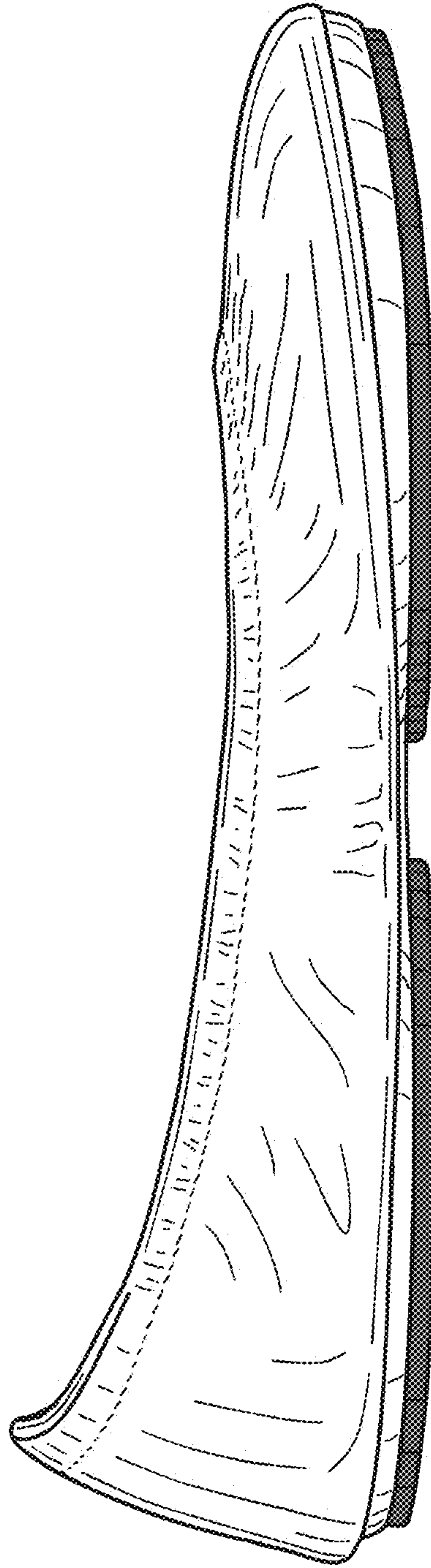

FIG. 23

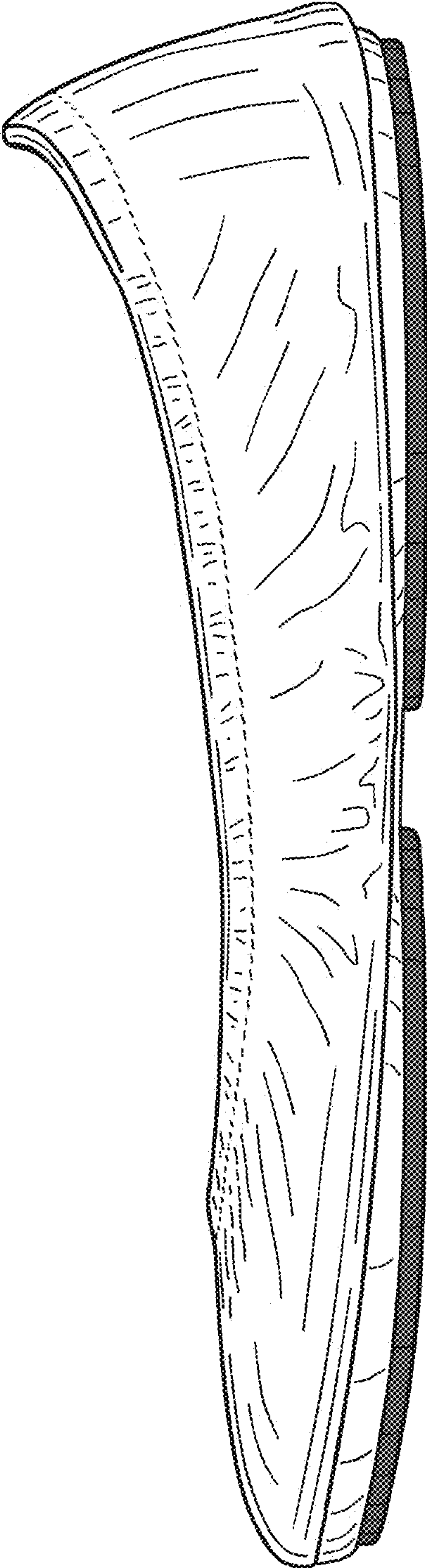

FIG. 24



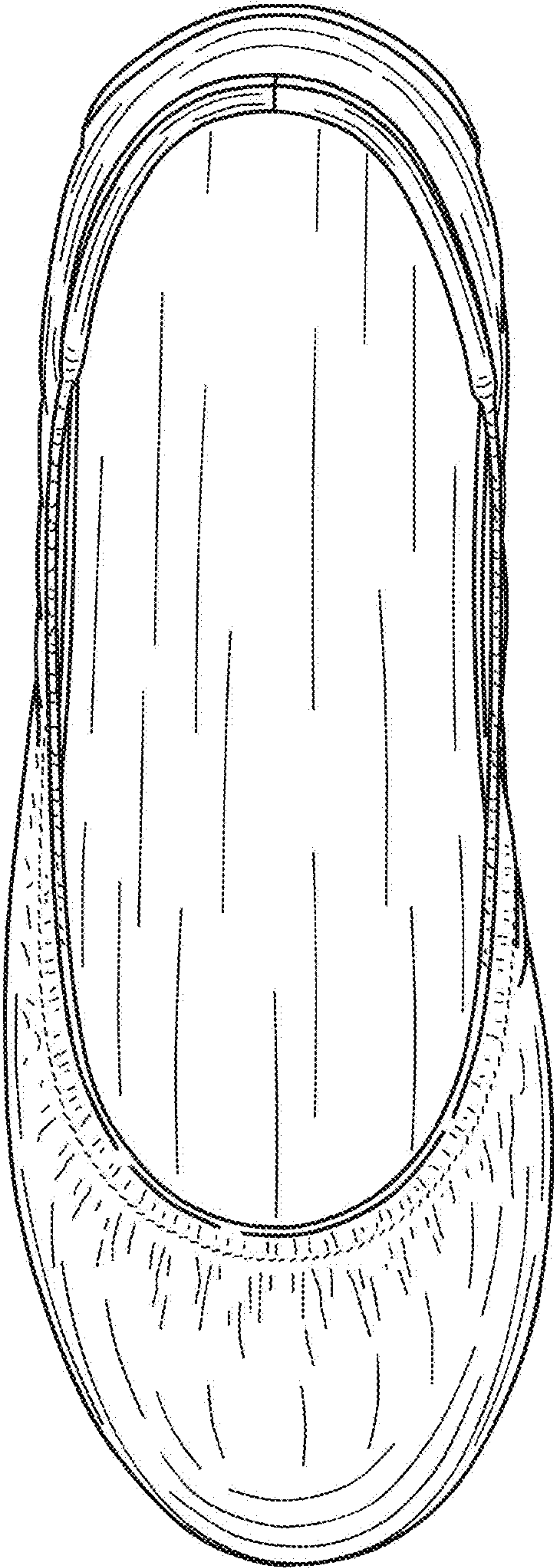

FIG. 25

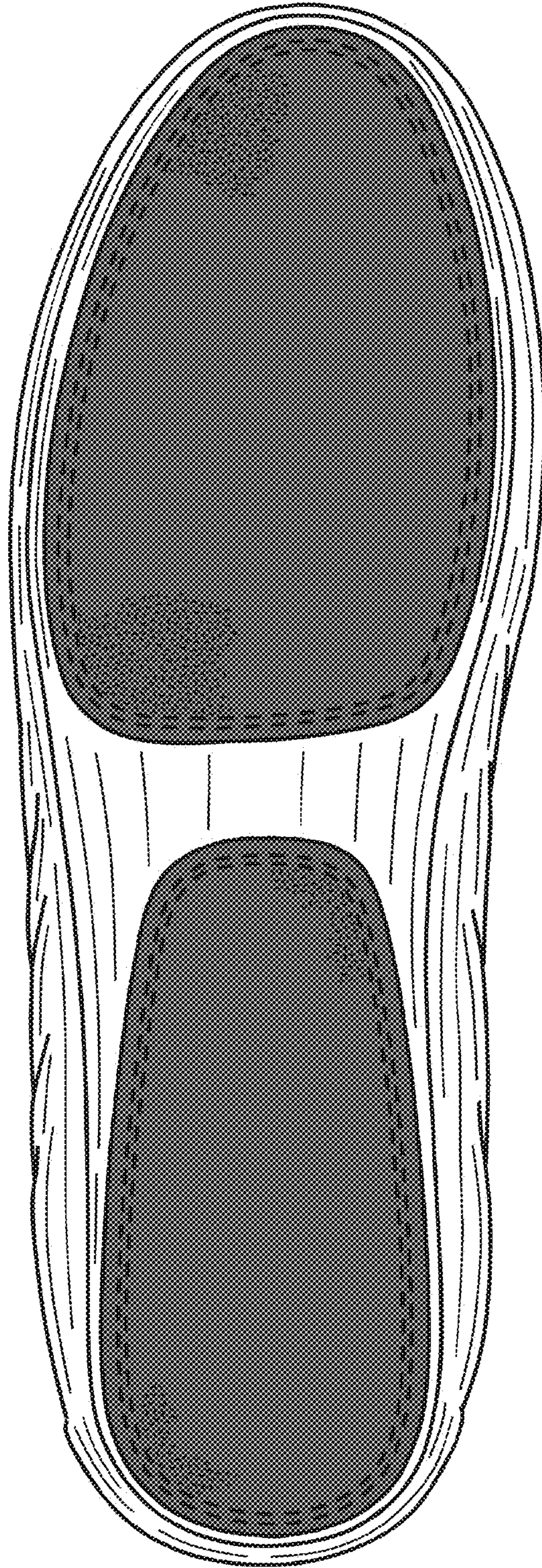

FIG. 26



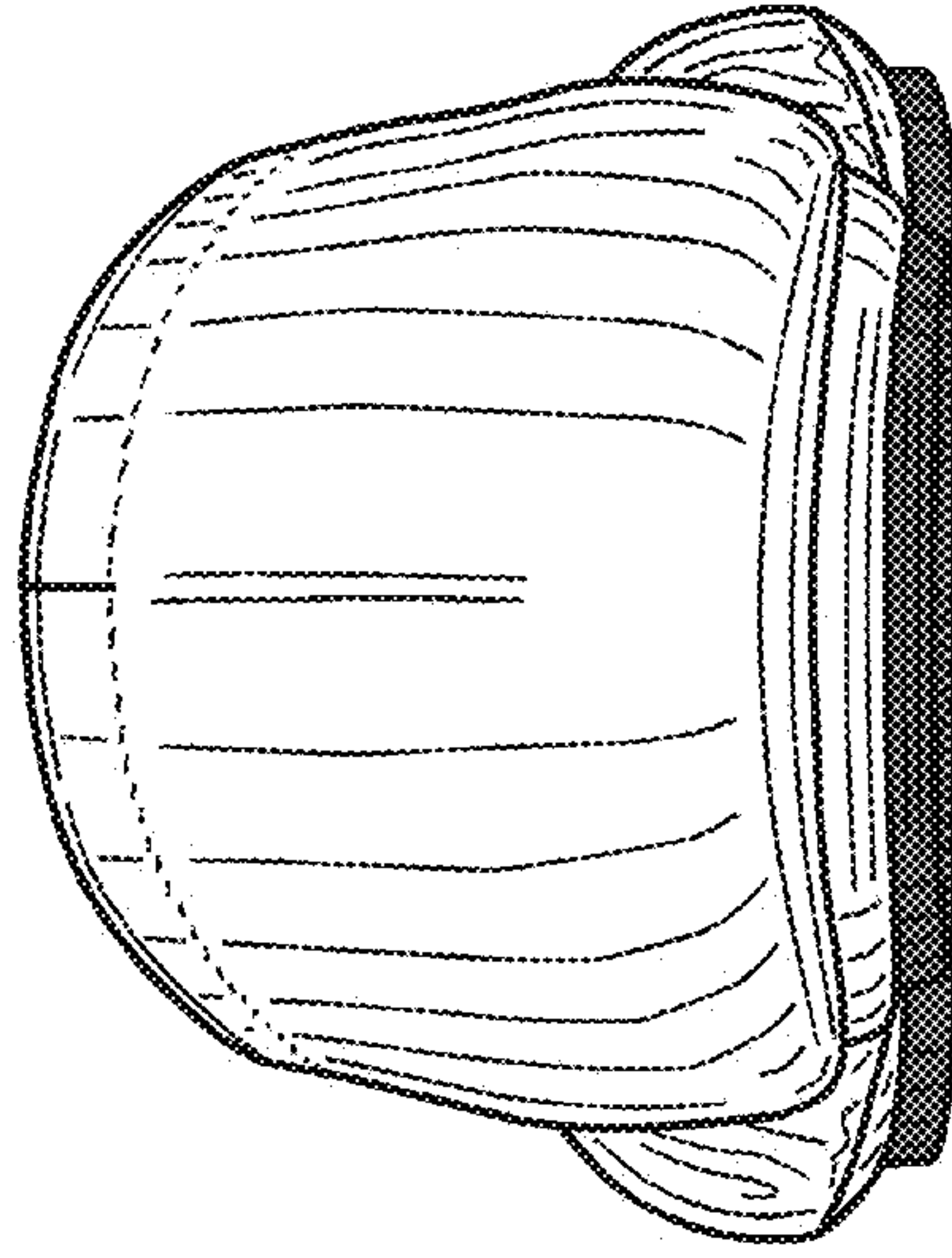

FIG. 27

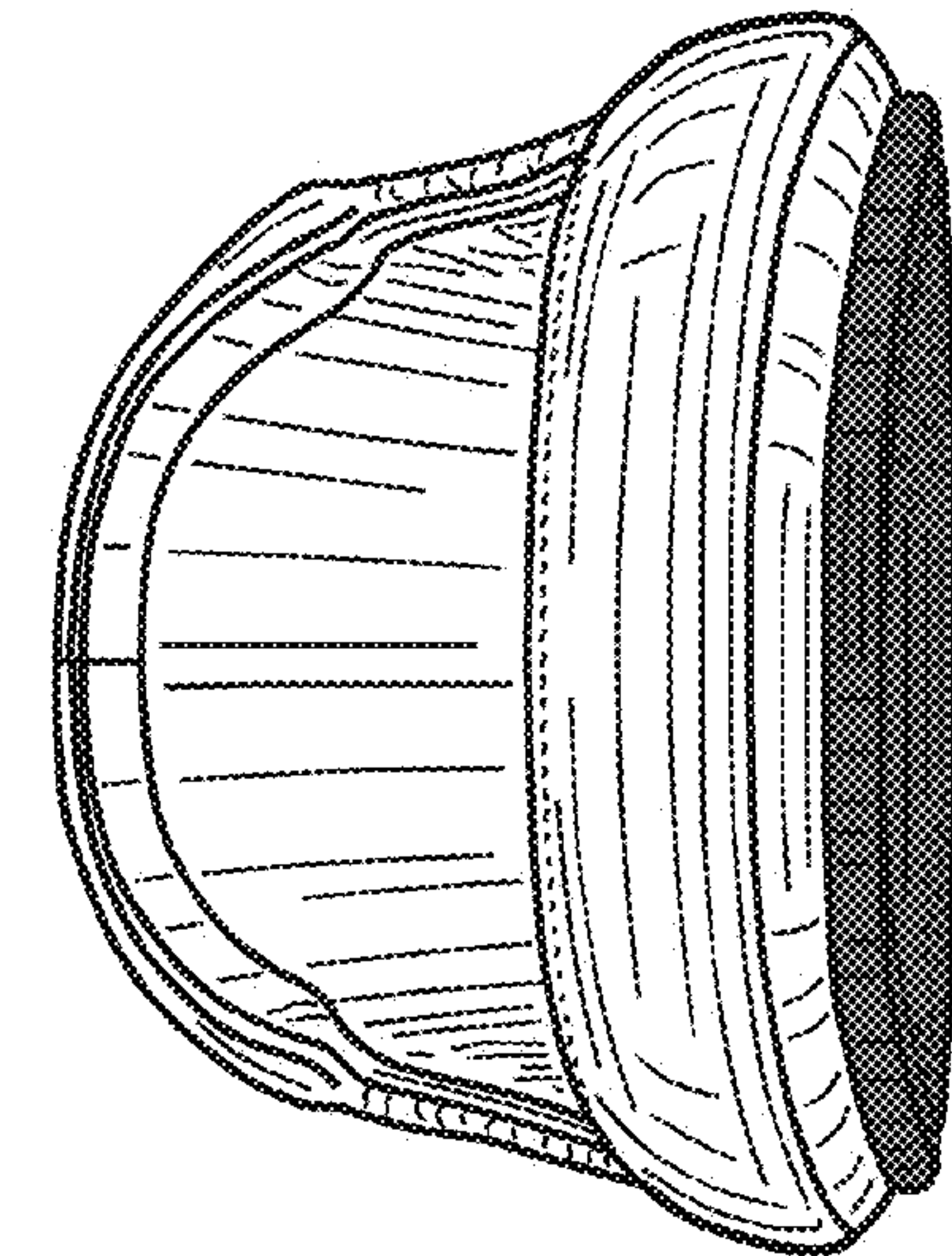

FIG. 28

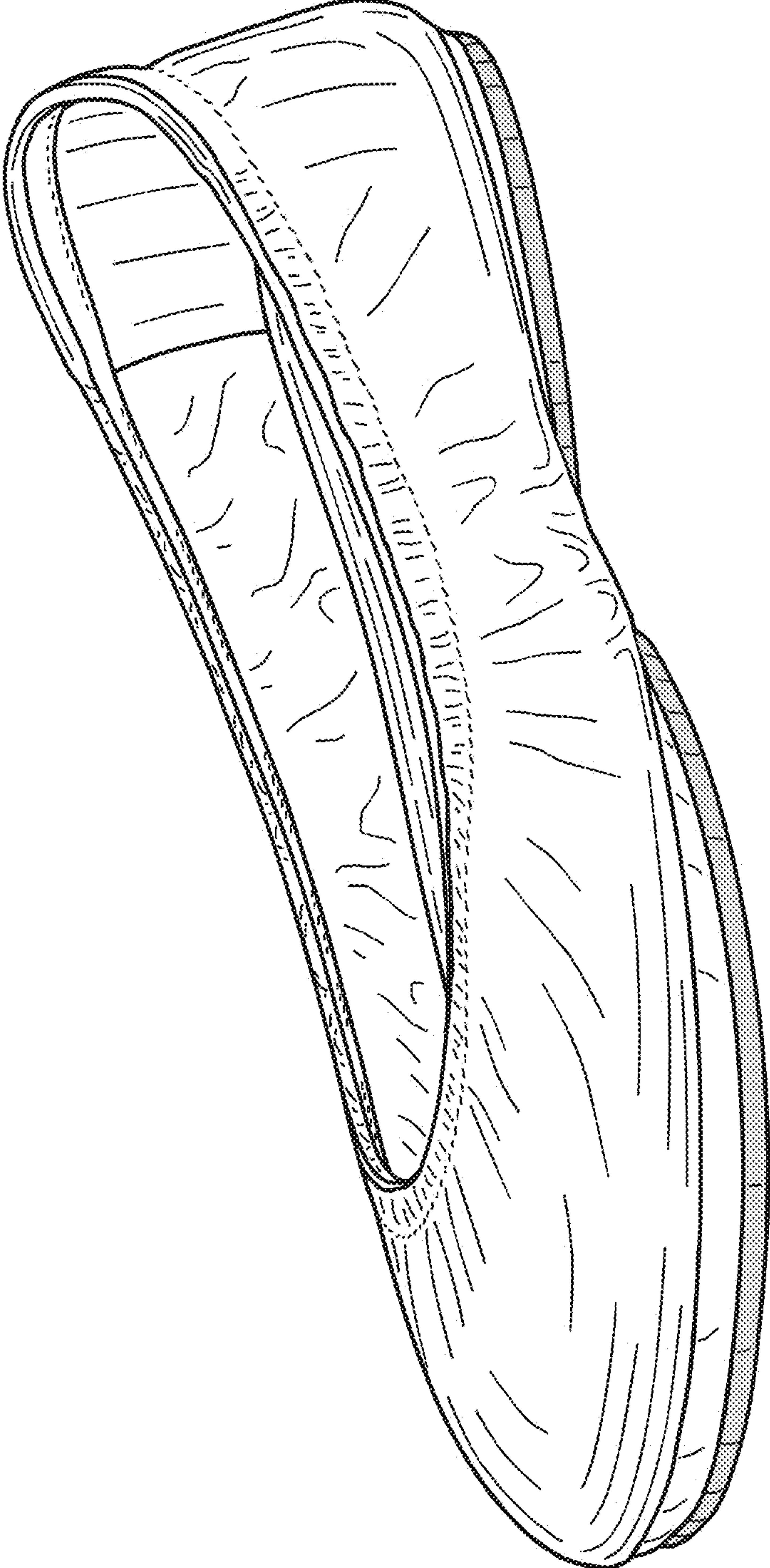

FIG. 29



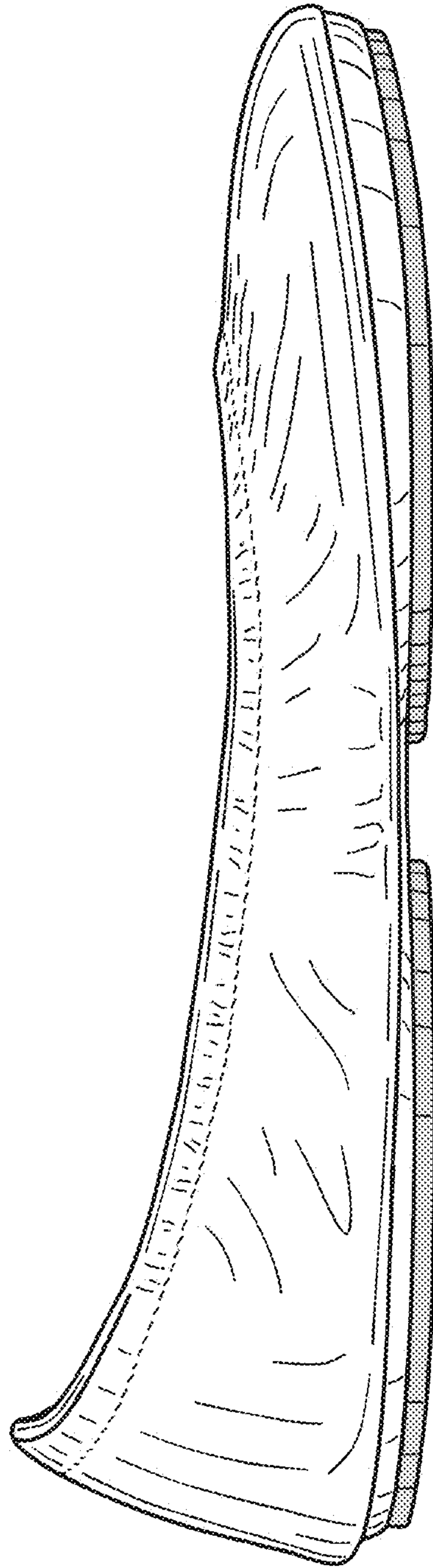

FIG. 30

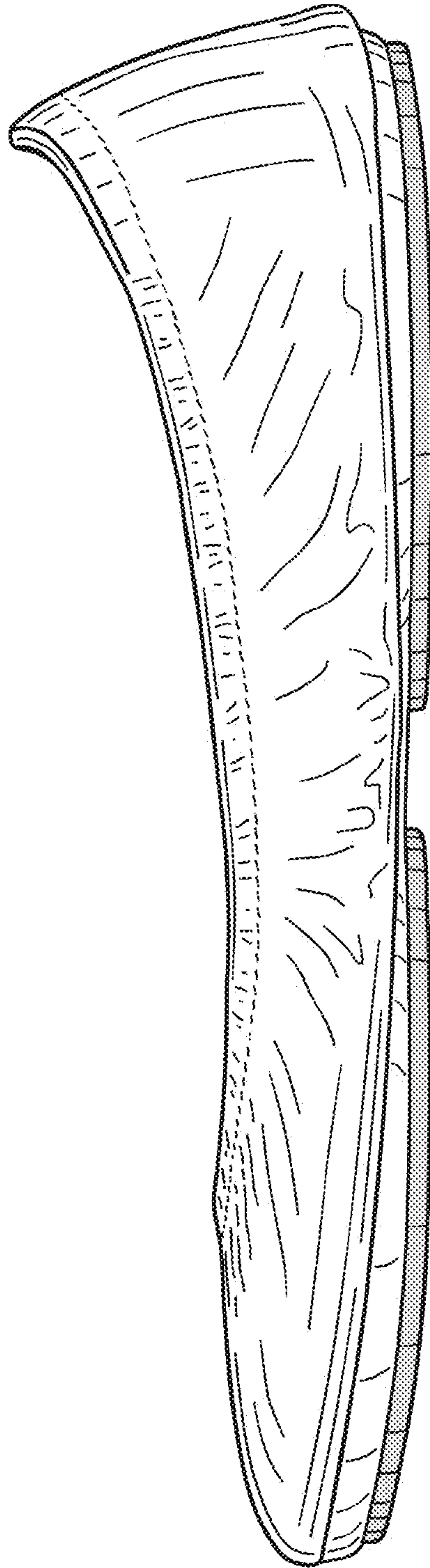

FIG. 31



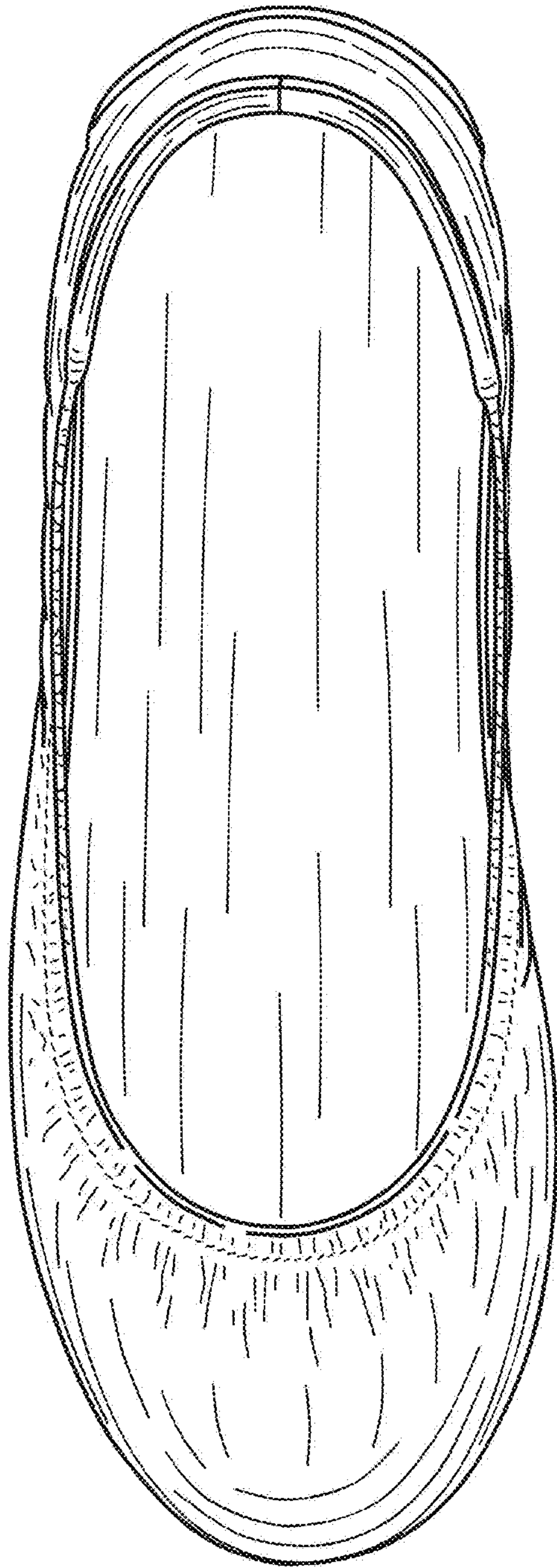

FIG. 32

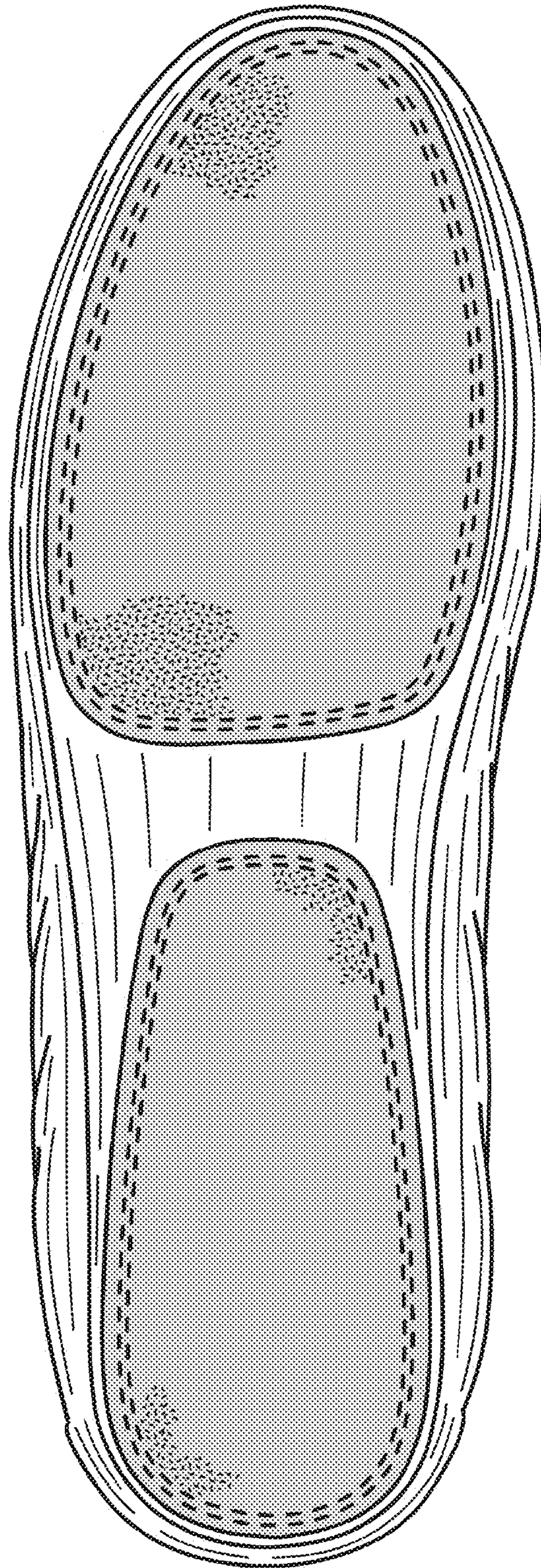

FIG. 33



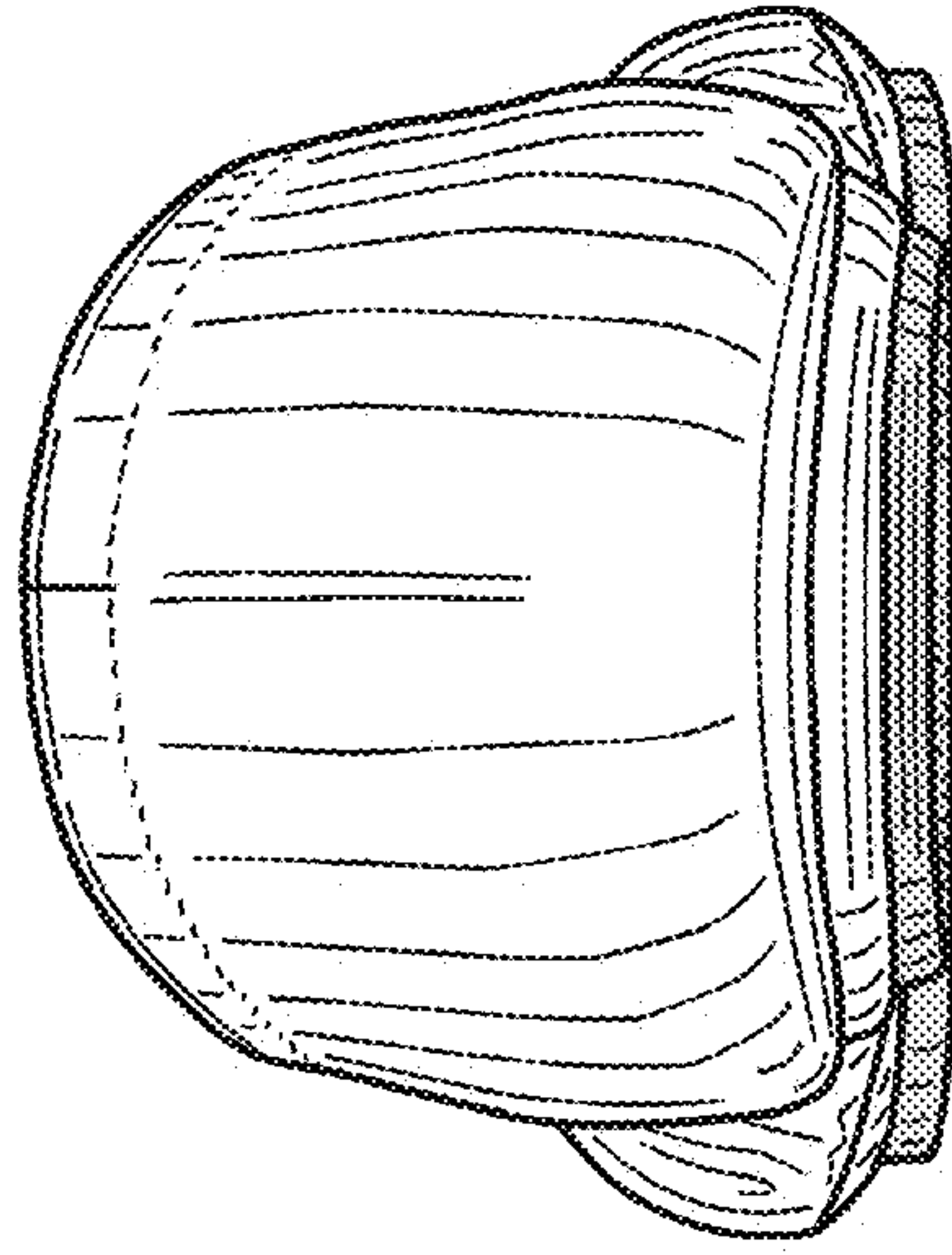

FIG. 35

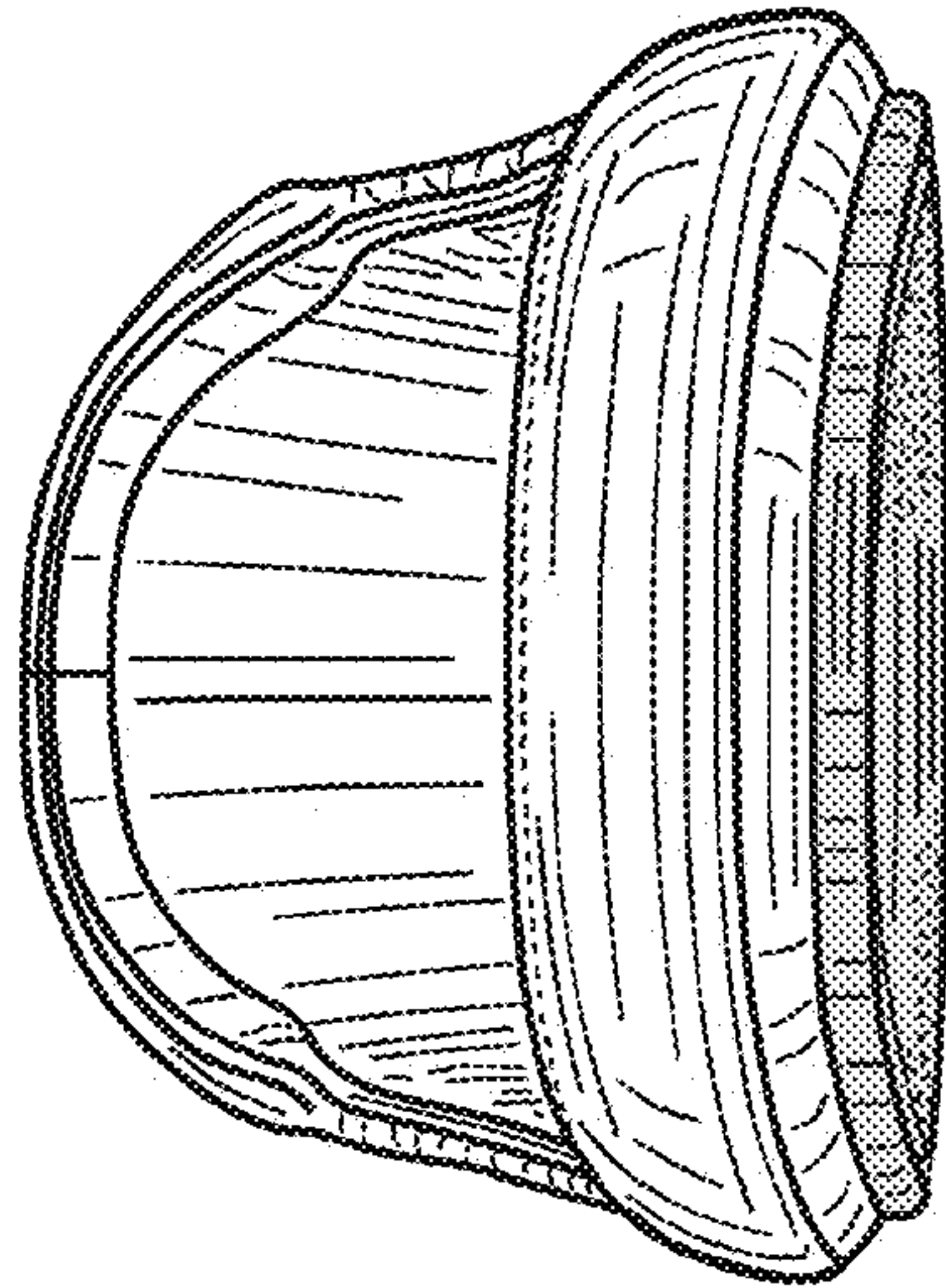

FIG. 34