



US00D886425S

(12) **United States Design Patent** (10) **Patent No.:** **US D886,425 S**  
**Rezaie** (45) **Date of Patent:** **\*\* Jun. 9, 2020**

(54) **SHOE OUTSOLE**  
(71) Applicant: **Olem Shoe Corp**, Miami, FL (US)  
(72) Inventor: **Shahin Rezaie**, Miami, FL (US)  
(\*\*) Term: **15 Years**  
(21) Appl. No.: **29/660,635**  
(22) Filed: **Aug. 22, 2018**  
(51) **LOC (12) Cl.** ..... **02-04**  
(52) **U.S. Cl.**  
USPC ..... **D2/950; D2/947**  
(58) **Field of Classification Search**  
USPC ..... D2/902, 906, 908, 916, 918, 925,  
D2/946-962, 977; 36/1, 1.5, 3 B, 22 R,  
36/24.5, 25 R, 28, 32 R, 34 R, 59 C,  
36/67 A, 101-107, 114-116, 117.3, 117.4,  
36/124-136  
CPC ..... A43B 13/00; A43B 13/02; A43B 13/023;  
A43B 13/026; A43B 13/04; A43B 13/08;  
A43B 13/10; A43B 13/12; A43B 13/14;  
A43B 13/141; A43B 13/143; A43B  
13/16; A43B 13/18; A43B 13/181; A43B  
13/187; A43B 13/189; A43B 13/20; A43B  
13/22; A43B 13/223; A43B 13/24; A43B  
13/28; A43B 13/30; A43B 13/32; A43B  
13/34; A43B 13/36  
See application file for complete search history.

(56) **References Cited**  
U.S. PATENT DOCUMENTS  
D246,337 S \* 11/1977 Niarhos ..... D2/918  
D586,542 S \* 2/2009 McClaskie ..... D2/951  
D589,240 S \* 3/2009 McClaskie ..... D2/951  
D599,535 S \* 9/2009 Del Biondi ..... D2/916  
D599,989 S \* 9/2009 McClaskie ..... D2/951  
D602,234 S \* 10/2009 Feller ..... D2/917  
D610,786 S \* 3/2010 Issler ..... D2/947  
D610,787 S \* 3/2010 McClaskie ..... D2/950

D615,737 S \* 5/2010 Feller ..... D2/896  
D625,496 S \* 10/2010 McClaskie ..... D2/951  
D625,908 S \* 10/2010 McClaskie ..... D2/951  
D654,257 S \* 2/2012 McClaskie ..... D2/950  
D654,672 S \* 2/2012 McClaskie ..... D2/950  
D654,675 S \* 2/2012 McClaskie ..... D2/950  
D674,174 S \* 1/2013 McClaskie ..... D2/950  
D674,175 S \* 1/2013 McClaskie ..... D2/950  
D691,359 S \* 10/2013 Della Valle ..... D2/950  
D697,701 S \* 1/2014 McClaskie ..... D2/948  
D698,135 S \* 1/2014 McClaskie ..... D2/948  
D699,421 S \* 2/2014 McClaskie ..... D2/948  
(Continued)

**OTHER PUBLICATIONS**

22270—Chantal—2, OlemShoe.com, [online], [site visited Dec. 4, 2019]. <URL: [https://www.olemshoe.com/CHANTAL-2\\_Pierre\\_Dumas.html](https://www.olemshoe.com/CHANTAL-2_Pierre_Dumas.html)> (Year: 2019).\*  
(Continued)

*Primary Examiner* — T Chase Nelson  
*Assistant Examiner* — Jonathan J. Han  
(74) *Attorney, Agent, or Firm* — Sanchelima & Associates PA; Jesus Sanchelima; Christian Sanchelima

(57) **CLAIM**  
The ornamental design for the shoe outsole, as shown and described.

**DESCRIPTION**

FIG. 1 is a front view of a shoe outsole showing my new design;  
FIG. 2 is a rear view thereof;  
FIG. 3 is a left side view thereof;  
FIG. 4 is a right side view thereof;  
FIG. 5 is a top view thereof; and,  
FIG. 6 is a bottom view thereof.  
The broken lines in the figures are used to illustrate environment and form no part of the claimed design.

**1 Claim, 5 Drawing Sheets**

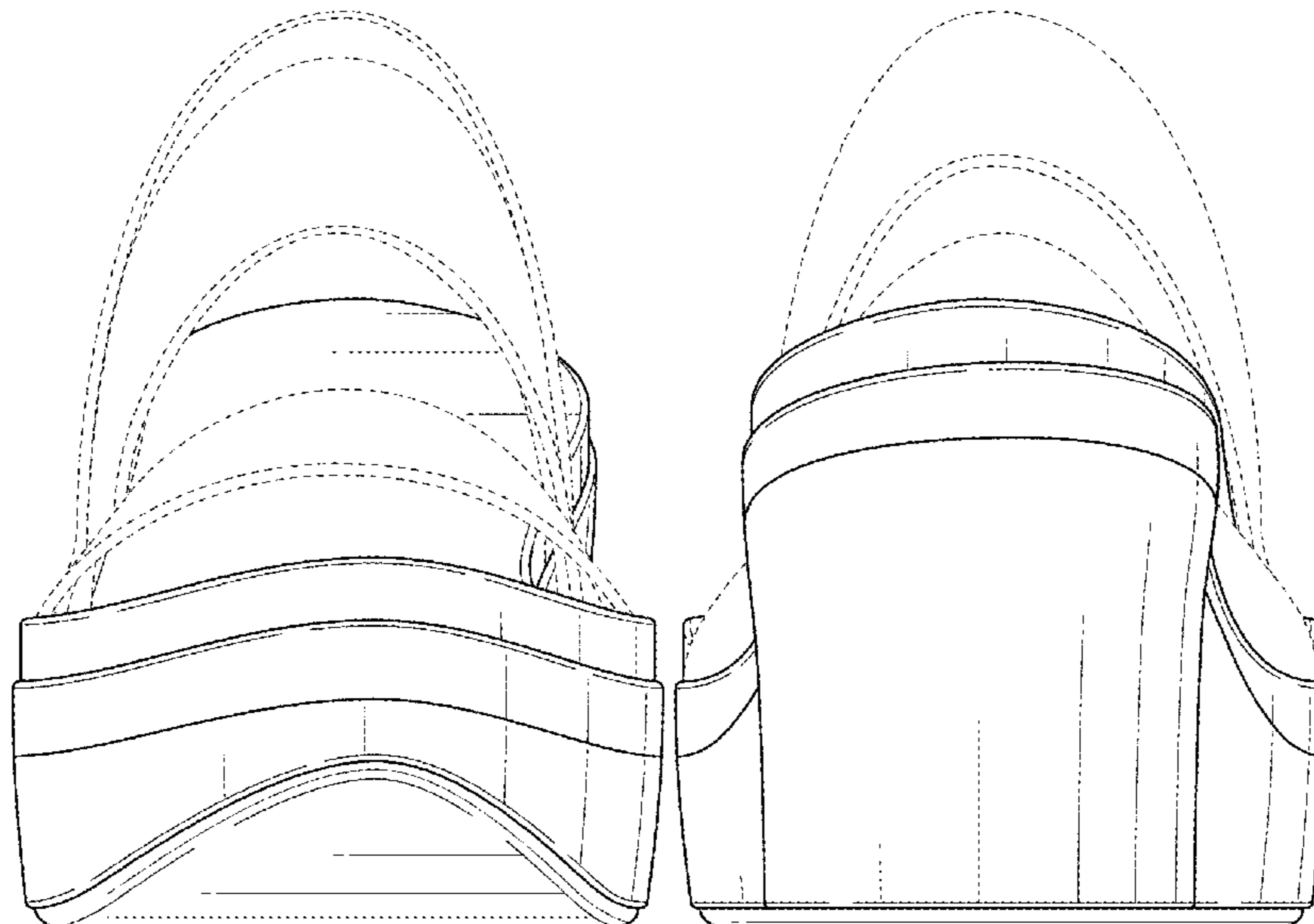

(56)

**References Cited**

## U.S. PATENT DOCUMENTS

D701,026	S	*	3/2014	McClaskie	.....	D2/948
D711,633	S	*	8/2014	Hunt	.....	D2/927
D714,037	S	*	9/2014	Della Valle	.....	D2/950
D725,351	S	*	3/2015	Tref	.....	D2/918
D735,979	S	*	8/2015	Santos	.....	D2/930
D794,291	S	*	8/2017	Carpenter	.....	D2/947
D808,143	S	*	1/2018	Negri	.....	D2/965
D841,946	S	*	3/2019	Egelja	.....	D2/917
D854,796	S	*	7/2019	Celin	.....	D2/950
2015/0040434	A1	*	2/2015	Perkins	.....	A43B 1/0054 36/101

## OTHER PUBLICATIONS

22271—Chantal—3, OlemShoe.com, [online], [site visited Dec. 4, 2019]. <URL: [https://www.olemshoe.com/CHANTAL-3\\_Pierre\\_Dumas.html](https://www.olemshoe.com/CHANTAL-3_Pierre_Dumas.html)> (Year: 2019).\*

Olem S'18 Chantal 2 Bronze Wedge Sandal, Amazon.com, Date first listed on Amazon: May 2, 2018, [online], [site visited Dec. 4, 2019]. <URL: <https://www.amazon.com/Olem-Chantal-Bronze-Wedge-Sandal/dp/B07CT6VV62?th=1>> (Year: 2018).\*

Fly London Women's Yand709fly Wedge Sandal, Amazon.com, Date first listed on Amazon: Feb. 1, 2017, [online], [site visited Dec. 4, 2019]. <URL: [https://www.amazon.com/FLY-London-Womens-Yand709fly-Sandal/dp/B07H1KL1V3/ref=pd\\_sbs\\_309\\_5/132-2524759-0679644?\\_encoding=UTF8&pd\\_rd\\_i=B075FHP4V4](https://www.amazon.com/FLY-London-Womens-Yand709fly-Sandal/dp/B07H1KL1V3/ref=pd_sbs_309_5/132-2524759-0679644?_encoding=UTF8&pd_rd_i=B075FHP4V4)> (Year: 2017).\*

Vionic Trixie Women's Platform Sandal, OrthoticShop.com, [online], [site visited Dec. 4, 2019]. <URL: <https://www.orthoticshop.com/vionic-trixie-womens-platform-sandal.html>> (Year: 2019).\*

\* cited by examiner

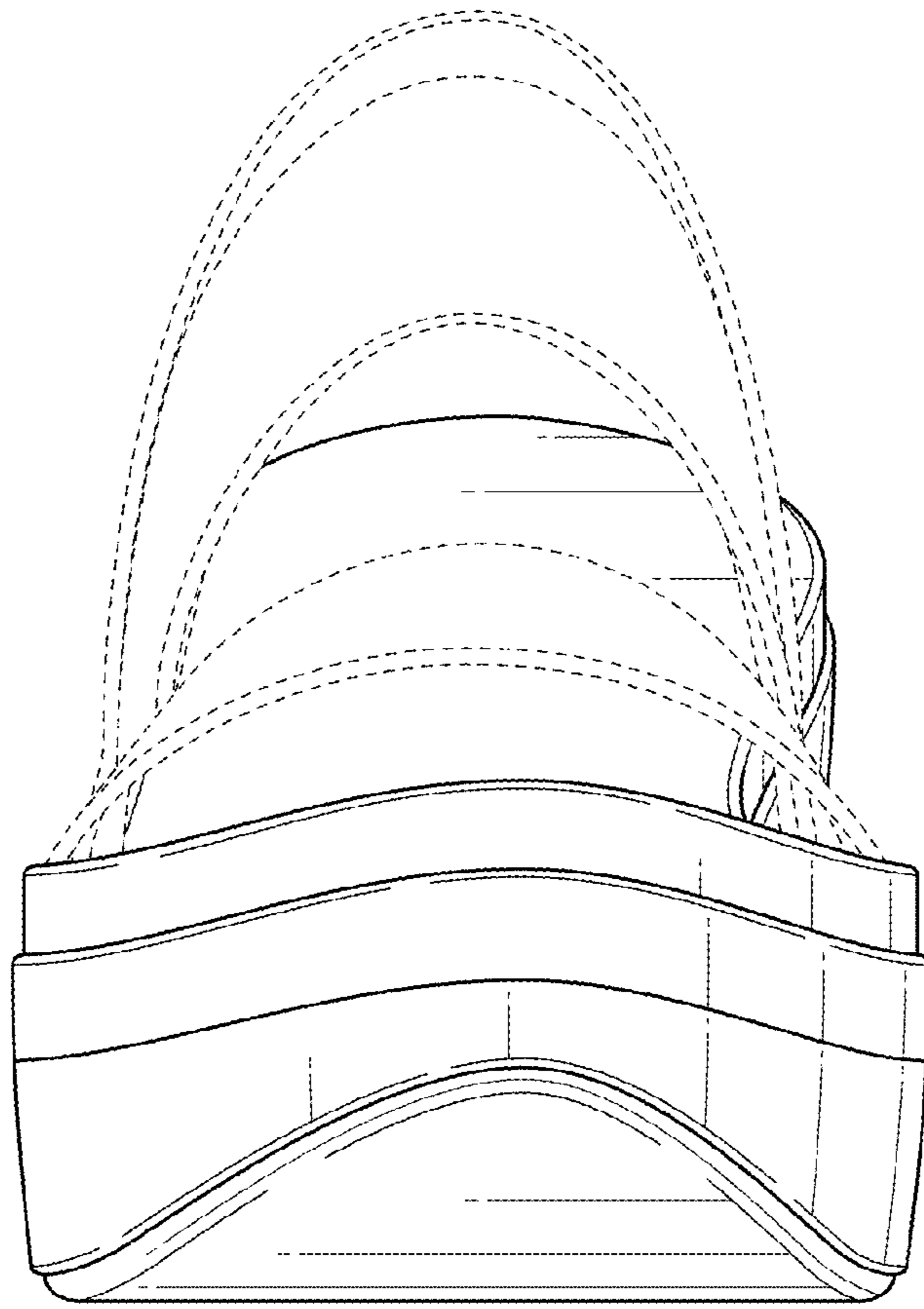

FIG. 1

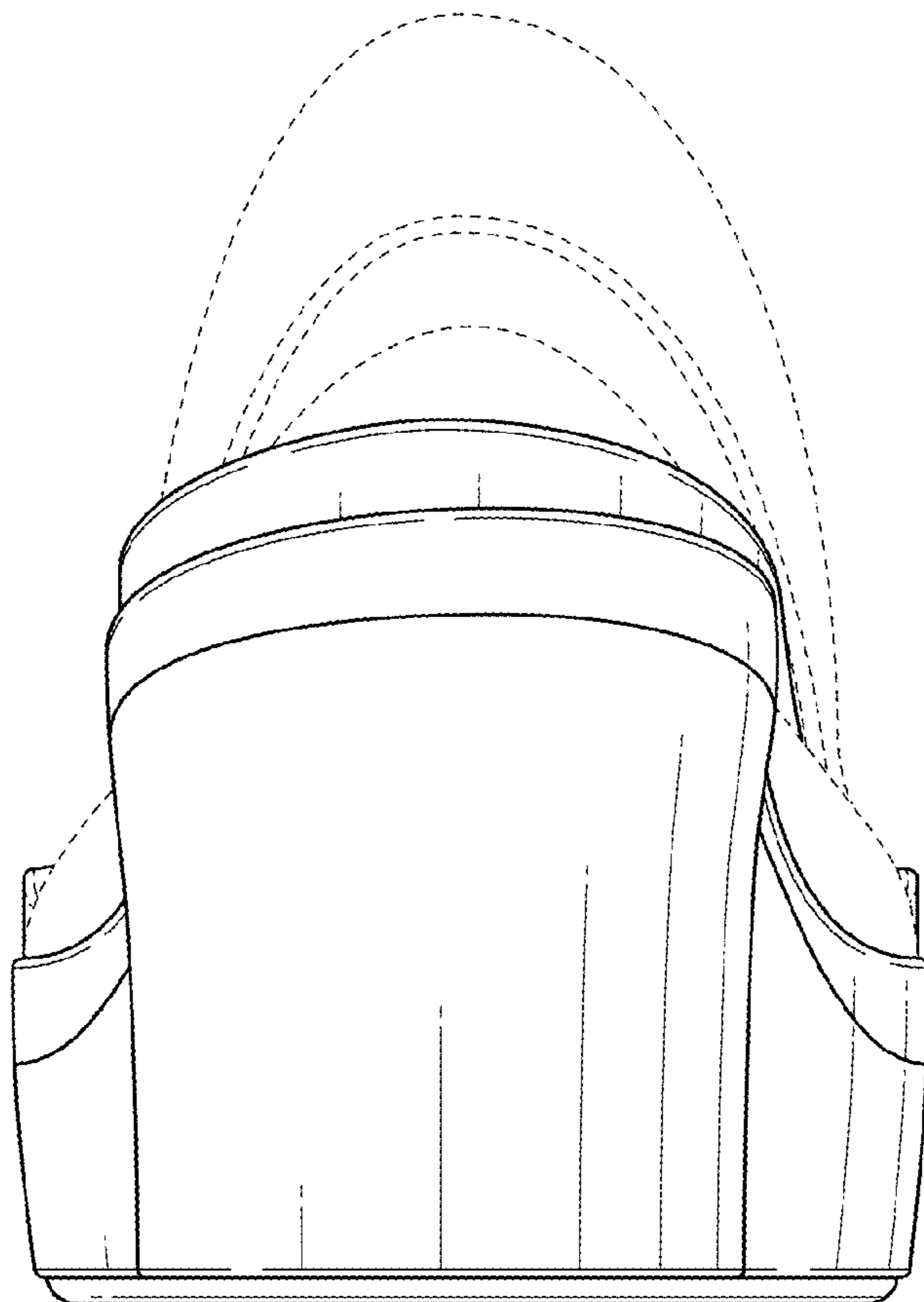

FIG. 2

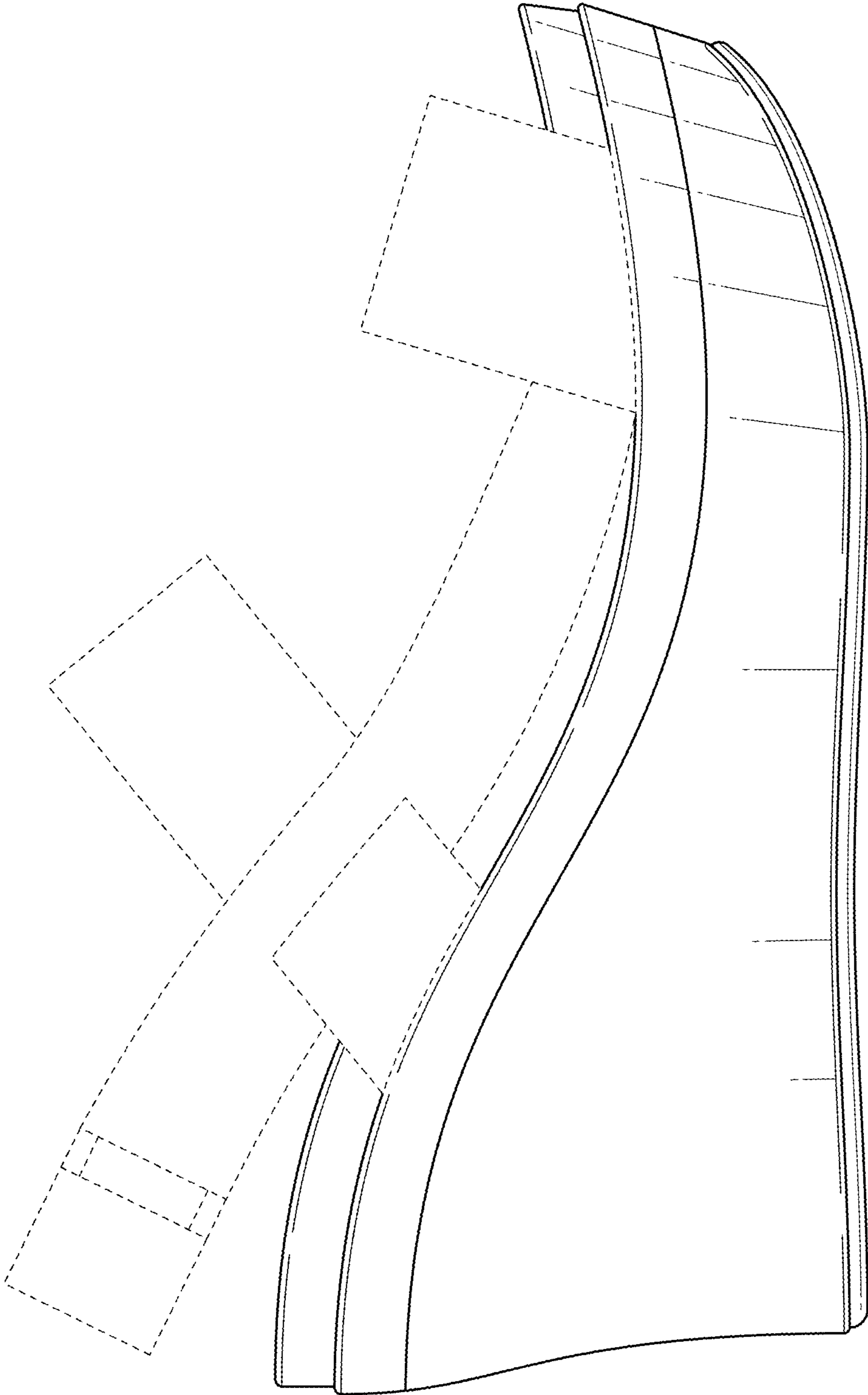

FIG. 3

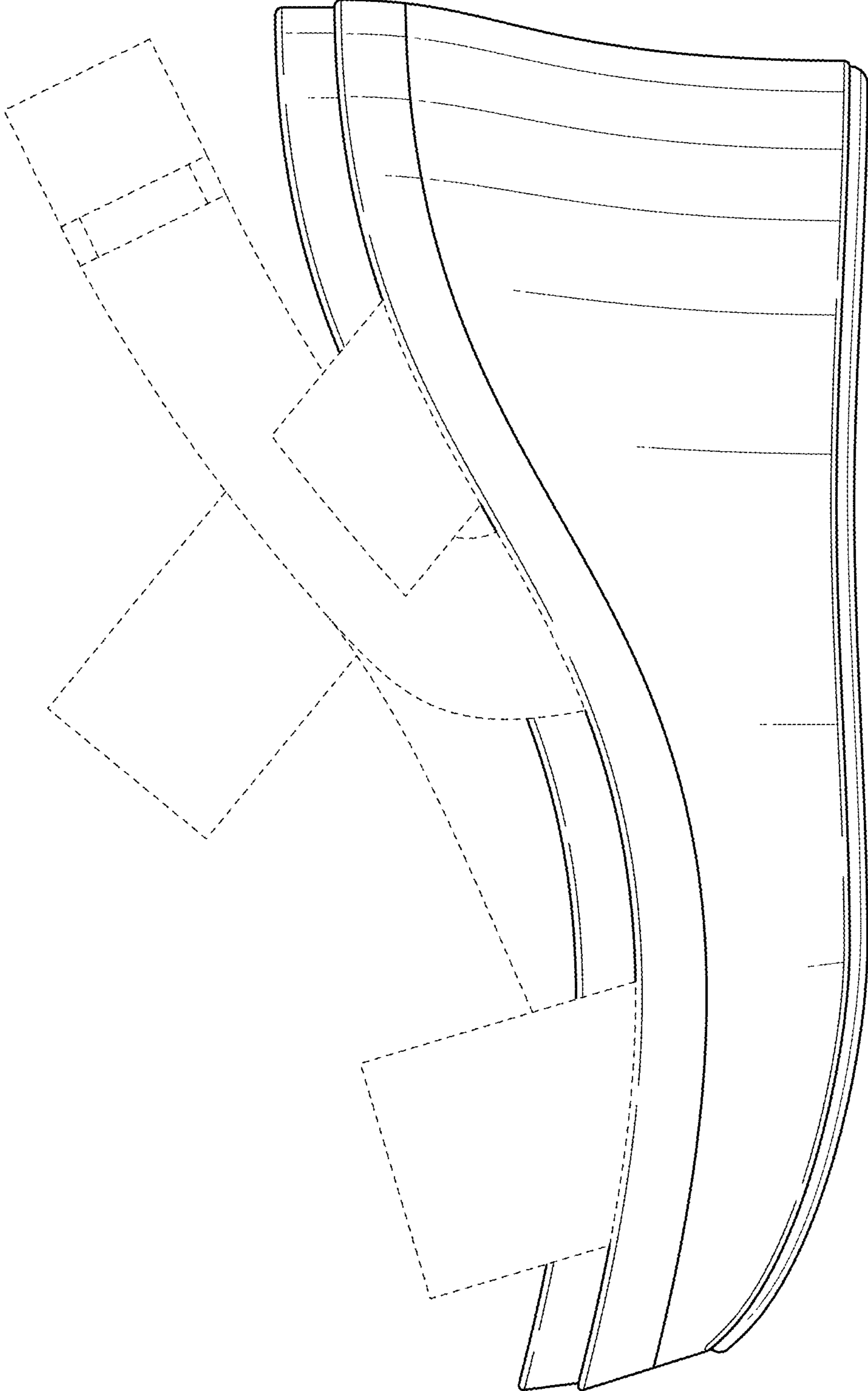

FIG. 4

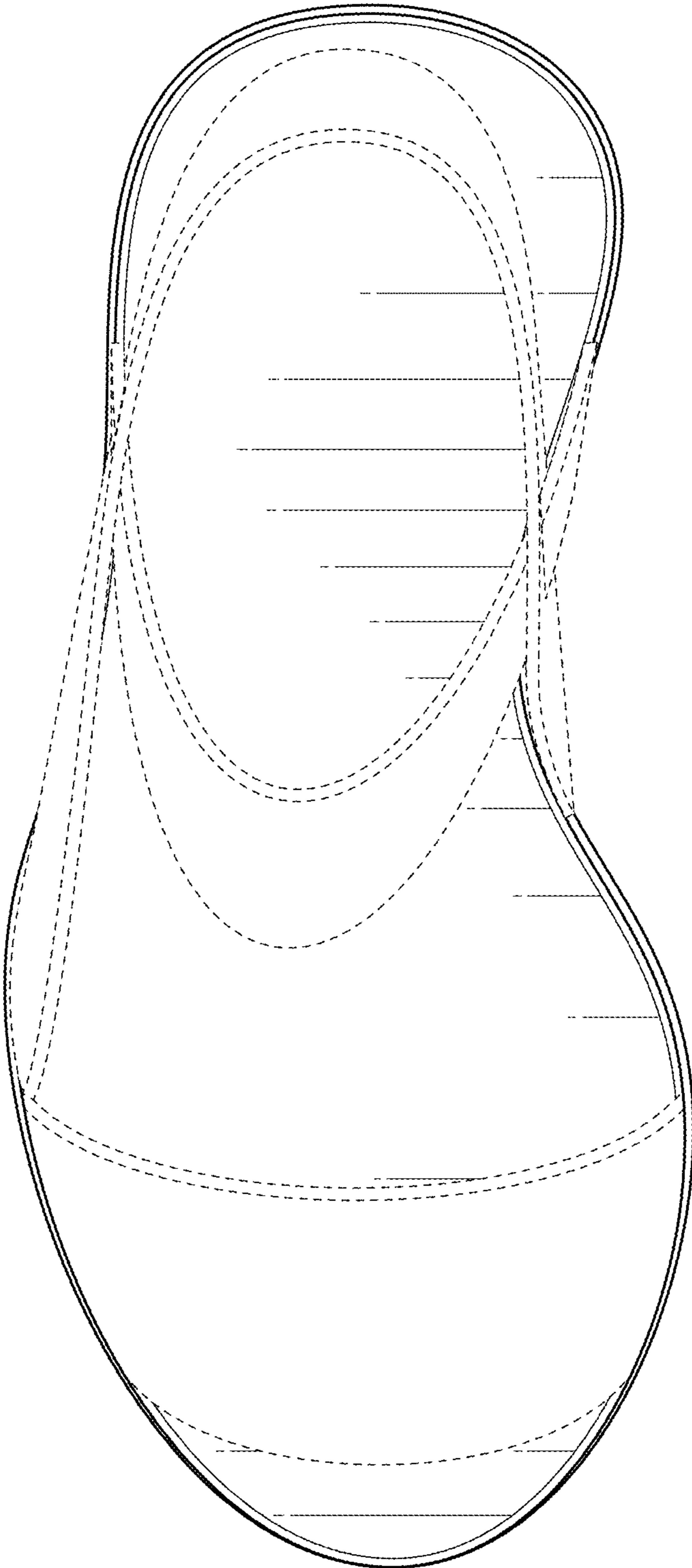

FIG. 5

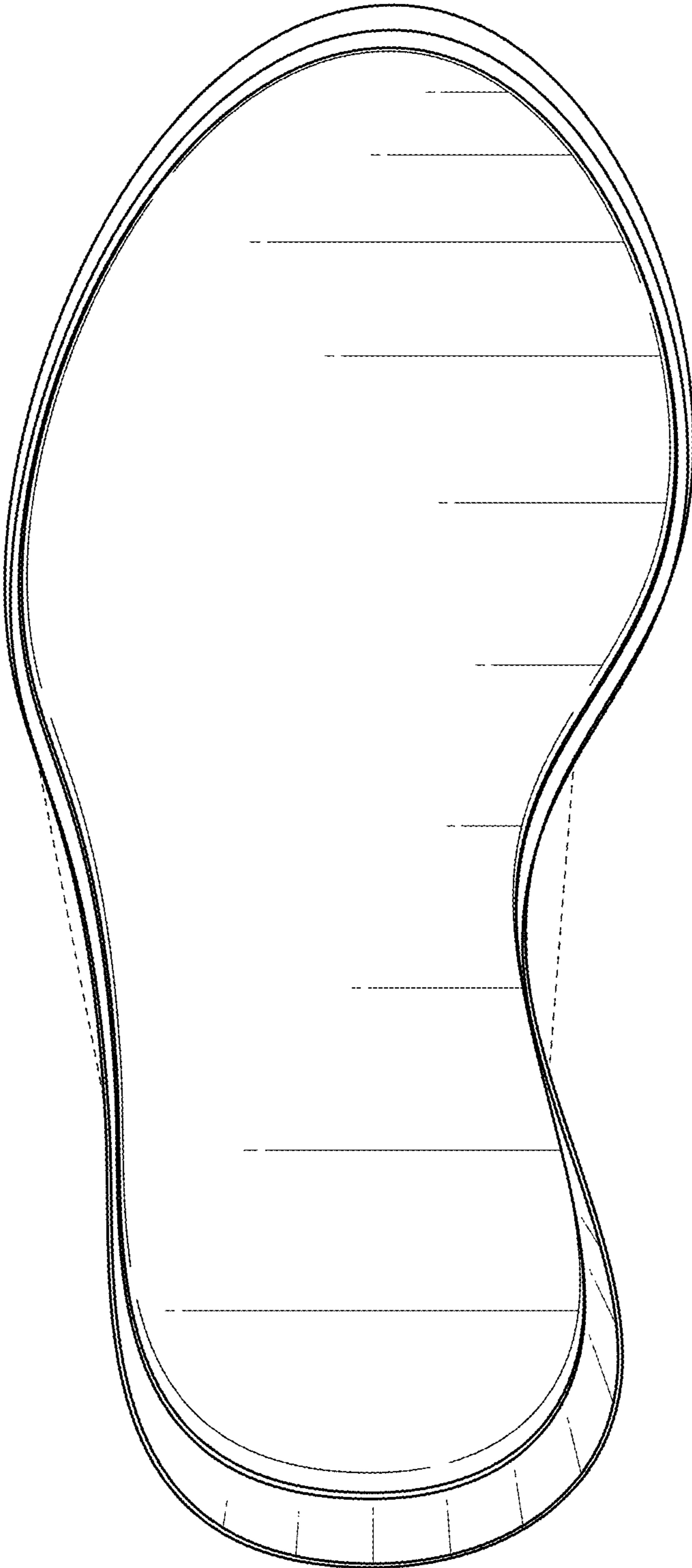

FIG. 6