



US00D886377S

(12) **United States Design Patent**
Tucker et al.

(10) **Patent No.:** **US D886,377 S**
(45) **Date of Patent:** **** Jun. 2, 2020**

- (54) **RAZOR CARTRIDGE**
- (71) Applicant: **SHAVELOGIC, INC.**, Dallas, TX (US)
- (72) Inventors: **William E. Tucker**, Attleboro, MA (US); **Douglas R. Kohring**, Arrowsic, ME (US)
- (73) Assignee: **ShaveLogic, Inc.**, Dallas, TX (US)
- (**) Term: **15 Years**
- (21) Appl. No.: **29/656,463**
- (22) Filed: **Jul. 12, 2018**
- (51) **LOC (12) Cl.** **28-03**
- (52) **U.S. Cl.**
USPC **D28/47**
- (58) **Field of Classification Search**
USPC D28/44–54
CPC ... B26B 21/00–12; B26B 21/14; B26B 21/16;
B26B 21/165; B26B 21/18; B26B 21/185;
B26B 21/20–227; B26B 19/00; B26B
19/10; B26B 19/12; B26B 19/14; B26B
19/38; B26B 19/02–107
See application file for complete search history.

6,854,188	B1 *	2/2005	Wonderley	B26B 21/225 30/527
7,152,512	B1 *	12/2006	Prochaska	B26B 21/225 83/13
7,461,458	B2 *	12/2008	Peysen	B26B 21/225 30/50
D603,097	S *	10/2009	Cataudella	D28/47
8,033,023	B2 *	10/2011	Johnson	B26B 21/225 30/50
D664,713	S *	7/2012	Christie	D28/47
D737,513	S *	8/2015	Lettenberger	D28/47
9,283,685	B2 *	3/2016	Griffin	B26B 21/521
9,475,202	B2 *	10/2016	Griffin	B26B 21/225
D775,423	S *	12/2016	Bae	D28/47
D816,912	S *	5/2018	Zucker	D28/47
D819,272	S *	5/2018	Evarts	D28/47
D819,887	S *	6/2018	Evarts	D28/47
10,131,063	B2 *	11/2018	Metcalf	B26B 21/14

* cited by examiner

Primary Examiner — Jennifer Rivard
Assistant Examiner — Alison M Ofstun
(74) *Attorney, Agent, or Firm* — Leber IP Law; Celia H. Leber

(57) **CLAIM**

The ornamental design for a razor cartridge, as shown and described.

DESCRIPTION

FIG. 1 is a top-left perspective view of the razor cartridge showing our new design;
FIG. 2 is a front view thereof;
FIG. 3 is a back view thereof;
FIG. 4 is a side view thereof;
FIG. 5 is a bottom view thereof; and,
FIG. 6 is top-left exploded perspective view thereof.
The broken lines illustrate portions of the razor cartridge and form no part of the claimed design.

1 Claim, 6 Drawing Sheets

(56) **References Cited**
U.S. PATENT DOCUMENTS

4,599,793	A *	7/1986	Iten	B26B 21/225 30/47
4,785,534	A *	11/1988	Lazarchik	B26B 21/225 30/50
5,347,717	A *	9/1994	Ts'ai	B26B 21/225 30/50
6,112,412	A *	9/2000	Richard	B26B 21/443 30/41.5
6,138,361	A *	10/2000	Richard	B26B 21/225 30/50
6,182,366	B1 *	2/2001	Richard	B26B 21/225 30/47

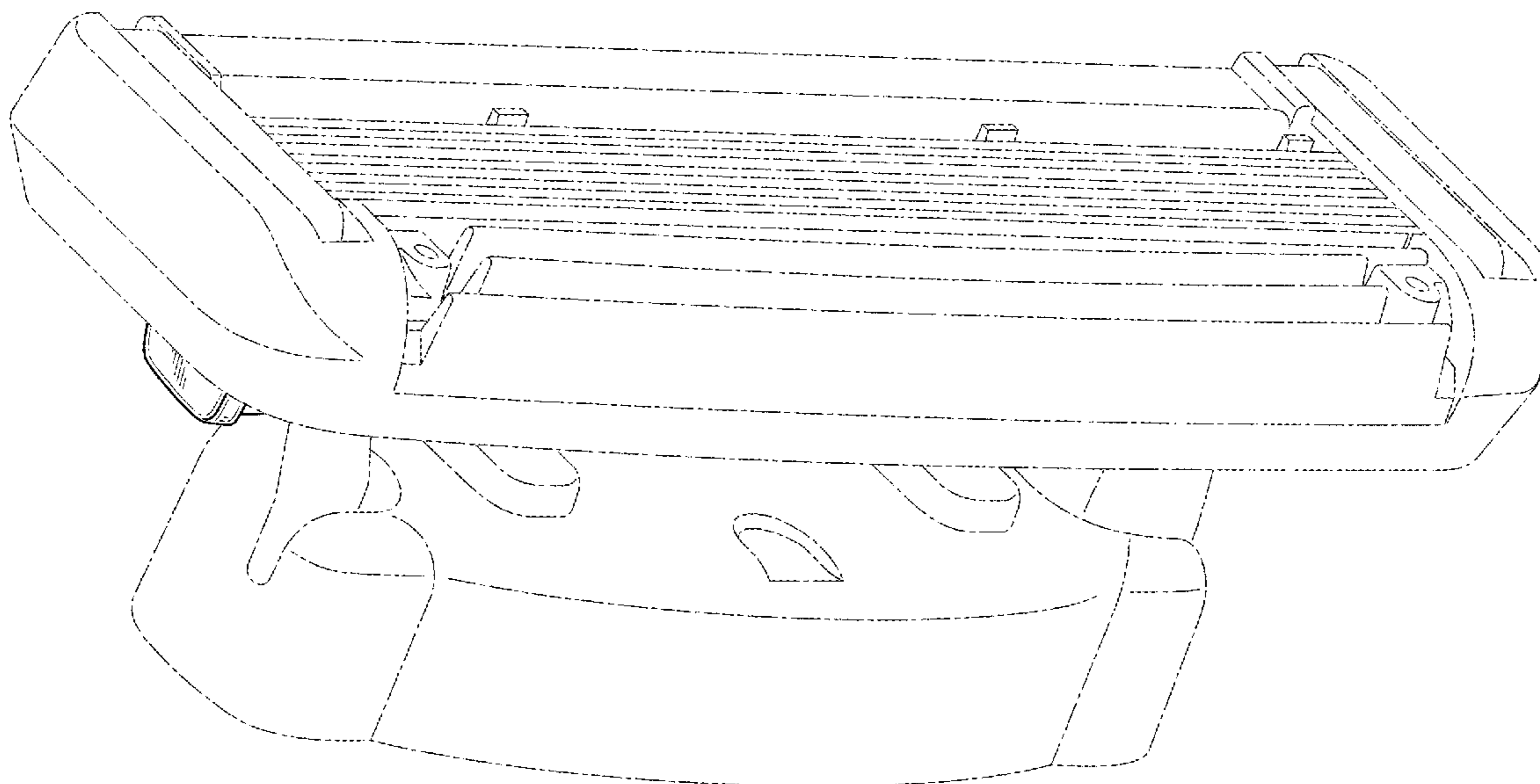

FIG. 1

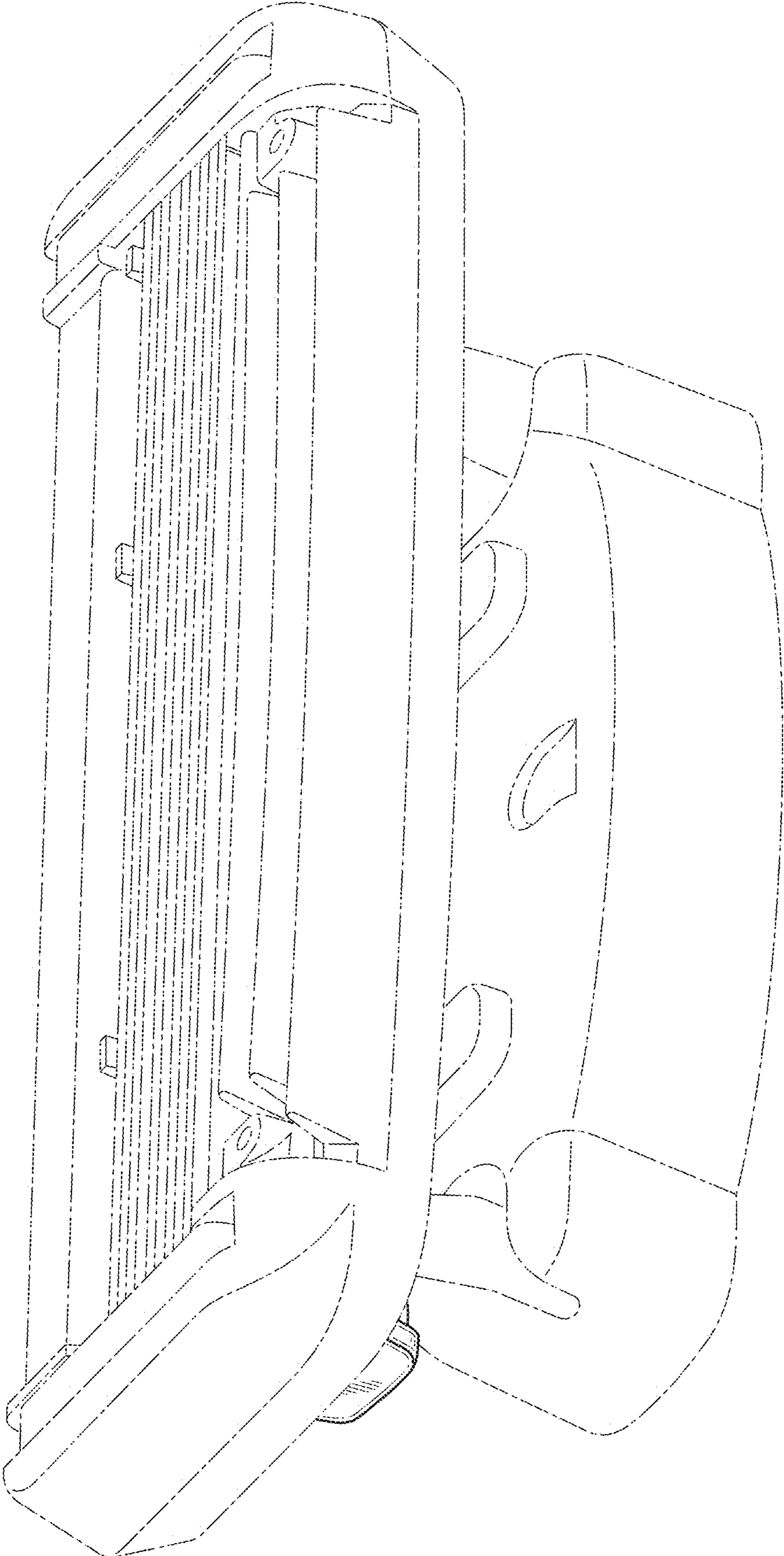

FIG. 2

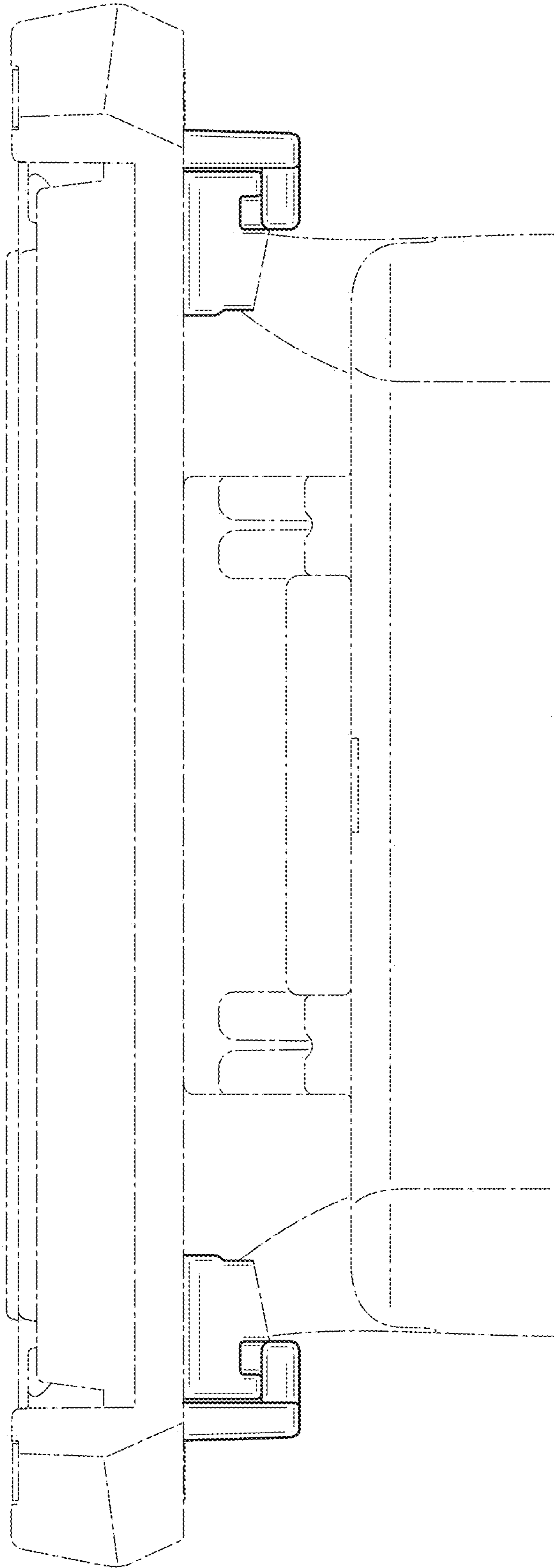

FIG. 3

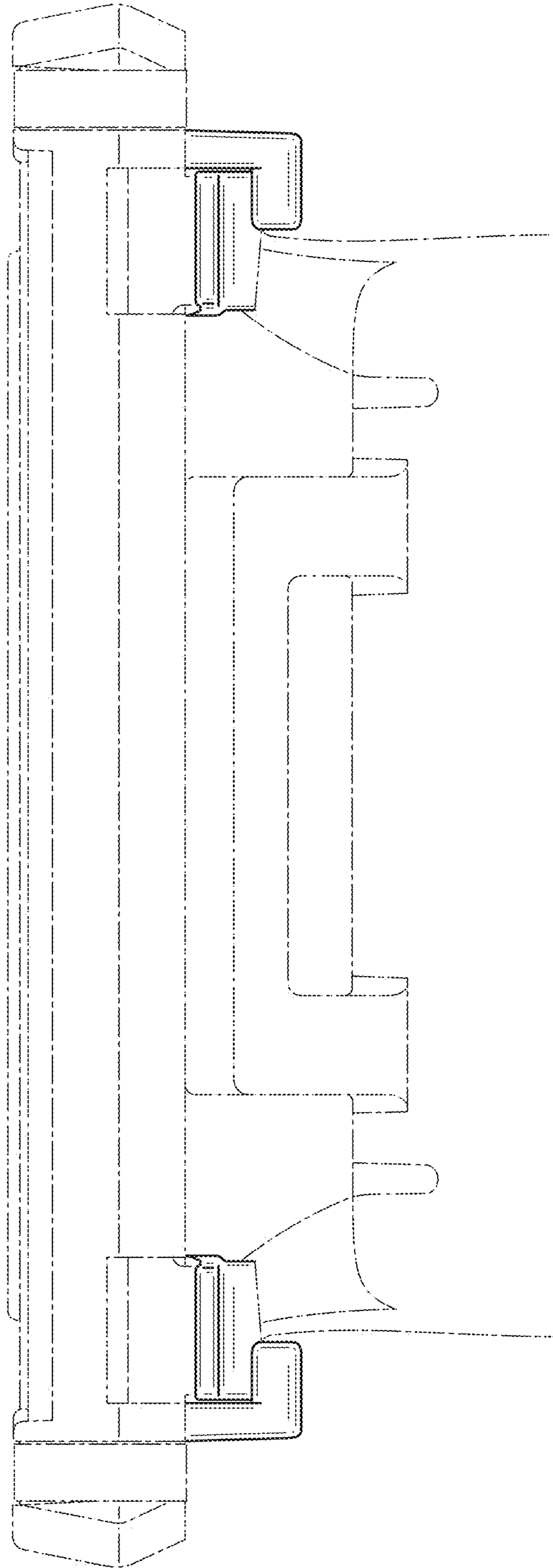

FIG. 4

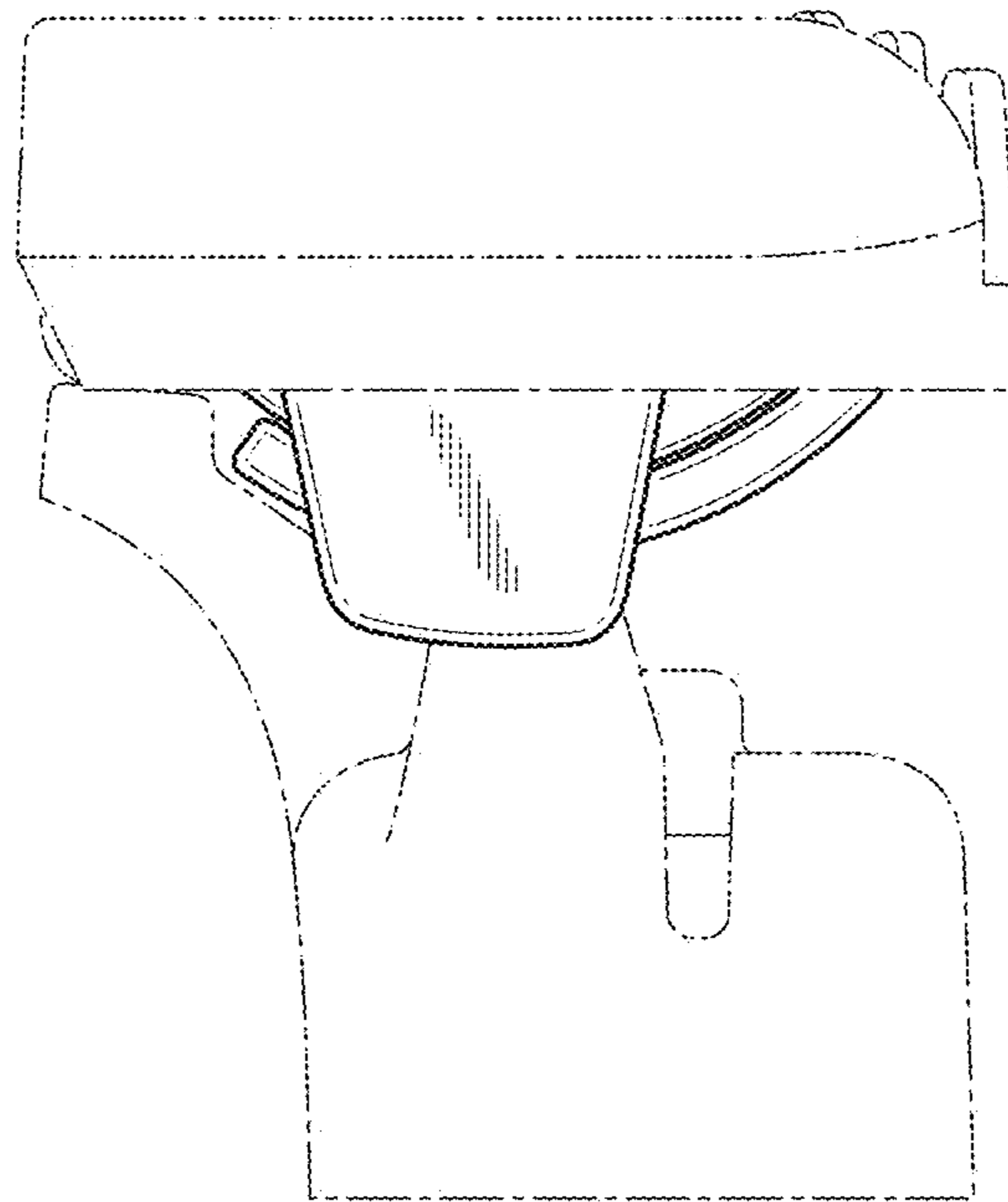
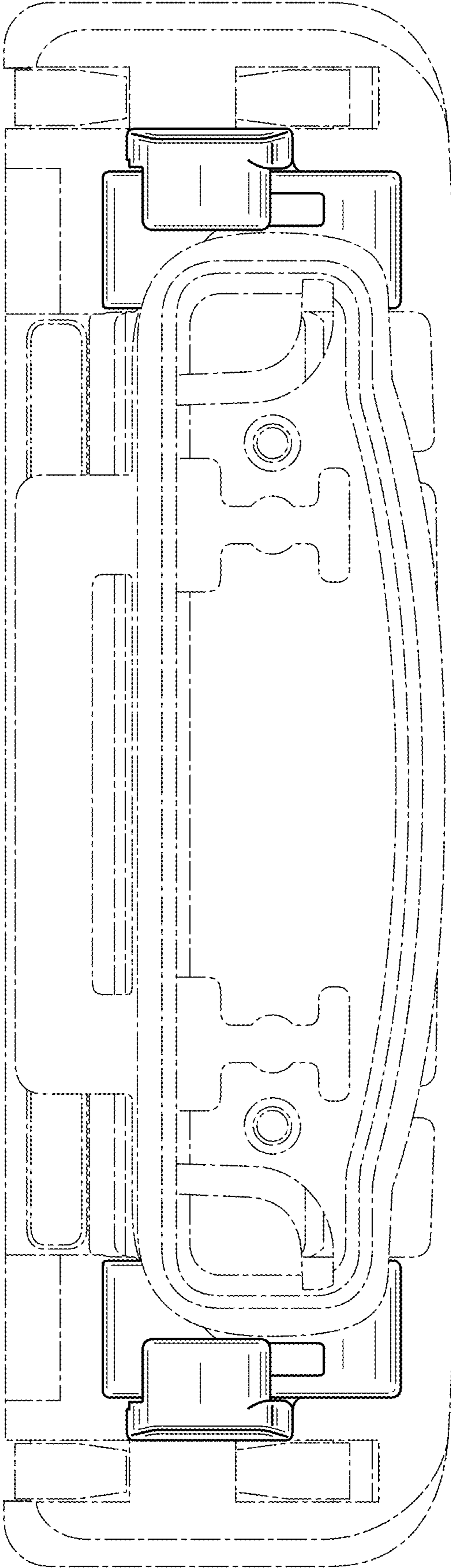

FIG. 5



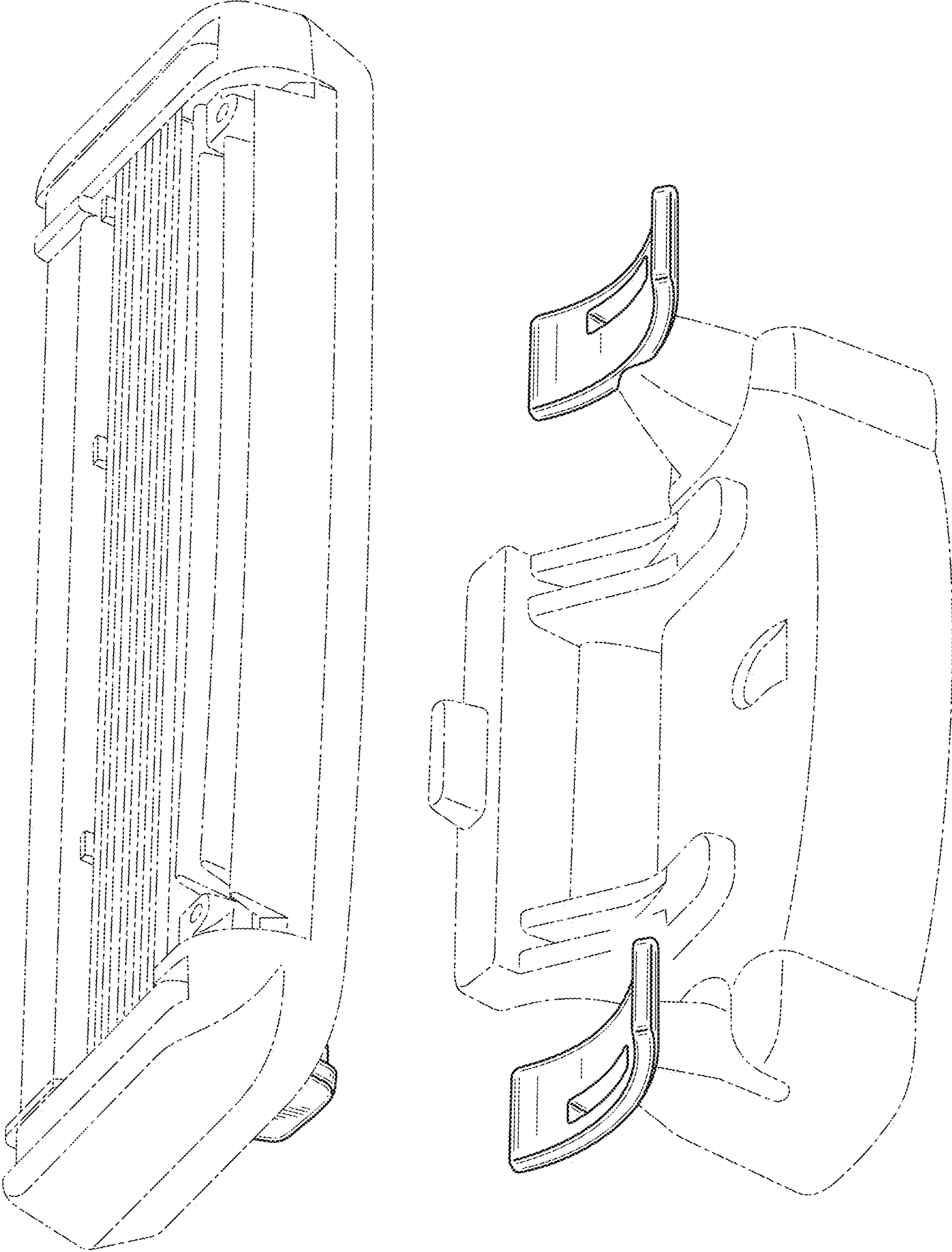

FIG. 6