



US00D886234S

(12) **United States Design Patent**
Lavoie et al.

(10) **Patent No.:** **US D886,234 S**
(45) **Date of Patent:** **** Jun. 2, 2020**

- (54) **FISHING POLE HOLDER**
- (71) Applicant: **DKR Manufacturing Inc.**, Sudbury (CA)
- (72) Inventors: **Roland Lavoie**, Sudbury (CA); **Patrick Timony**, Sudbury (CA)
- (73) Assignee: **DKR Manufacturing Inc.**, Sudbury, Ontario (CA)
- (**) Term: **15 Years**
- (21) Appl. No.: **29/679,821**
- (22) Filed: **Feb. 11, 2019**
- (51) **LOC (12) Cl.** **22-05**
- (52) **U.S. Cl.**
USPC **D22/147**
- (58) **Field of Classification Search**
USPC D22/147, 199; 43/21.2, 25; 224/228, 224/567, 922; 248/156, 314, 517, 530, 248/694
CPC A01K 97/10
See application file for complete search history.

D845,206 S 4/2019 Lavoie et al.

* cited by examiner

Primary Examiner — Catherine R Oliver-Garcia

(57) **CLAIM**

The ornamental design for a fishing pole holder, as shown and described.

DESCRIPTION

FIG. 1 is an isometric view of an embodiment of the fishing pole holder of the invention in a disengaged condition; FIG. 2 is a first side view thereof; FIG. 3 is a front view thereof; FIG. 4 is a second side view thereof; FIG. 5 is a rear view thereof; FIG. 6 is a top view thereof; FIG. 7 is a bottom view thereof; FIG. 8 is a side view of the fishing pole holder of FIGS. 1-7 in an engaged condition showing environment; FIG. 9 is an isometric view of an alternative embodiment of the fishing pole holder of the invention; FIG. 10 is a first side view thereof; FIG. 11 is a front view thereof; FIG. 12 is a second side view thereof; FIG. 13 is a rear view thereof; FIG. 14 is a top view thereof; FIG. 15 is a bottom view thereof; and, FIG. 16 is a side view of the fishing pole holder of FIGS. 9-15 in an engaged condition showing environment. The broken lines in FIGS. 8 and 16 illustrate environment, and form no part of the claimed design.

(56) **References Cited**

U.S. PATENT DOCUMENTS

D202,432 S *	9/1965	Turiace, Jr.	D22/147
D215,436 S *	10/1969	Moore	D22/147
D222,964 S *	2/1972	Woodbury	D22/147
D267,031 S *	11/1982	Hamlin	D22/147
D332,821 S *	1/1993	Padilla	D22/147
5,967,075 A *	10/1999	Johansen	A47B 23/02 43/21.2
6,185,855 B1 *	2/2001	Sizer	A01K 97/01 43/21.2

1 Claim, 10 Drawing Sheets

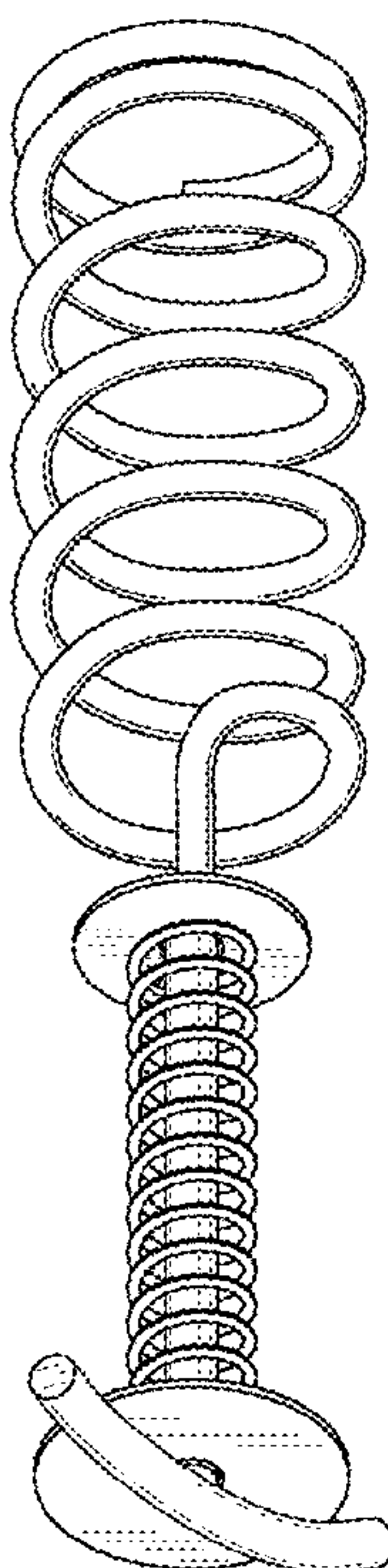

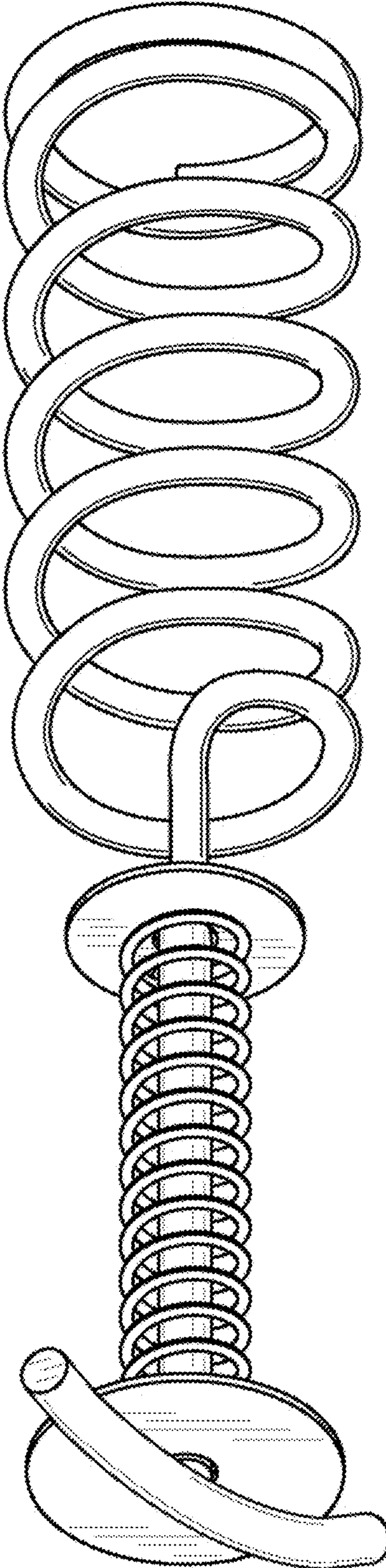

FIG. 1

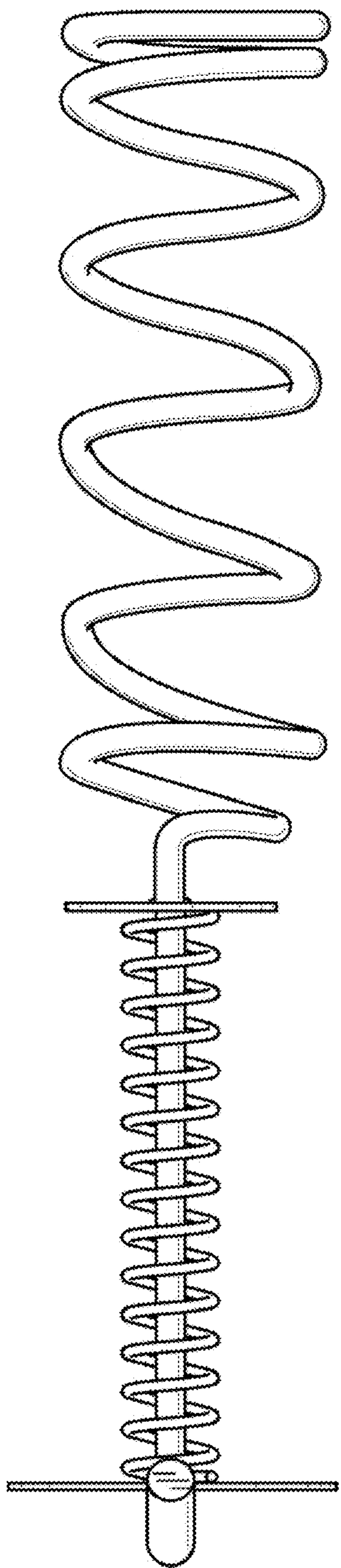

FIG. 2

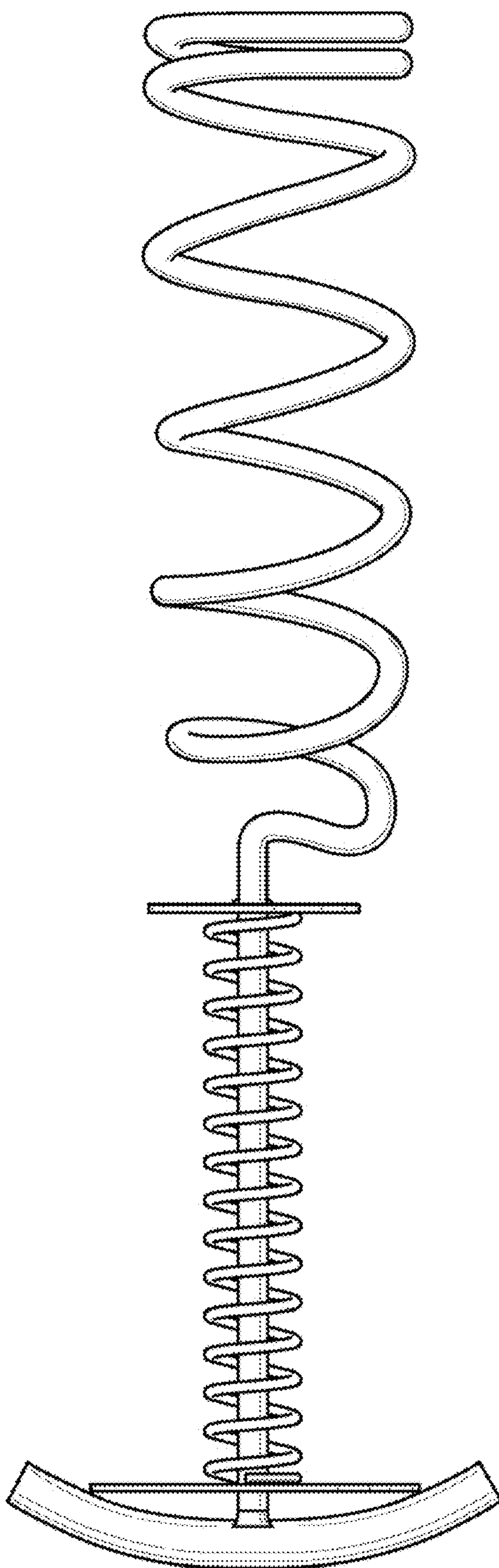

FIG. 3

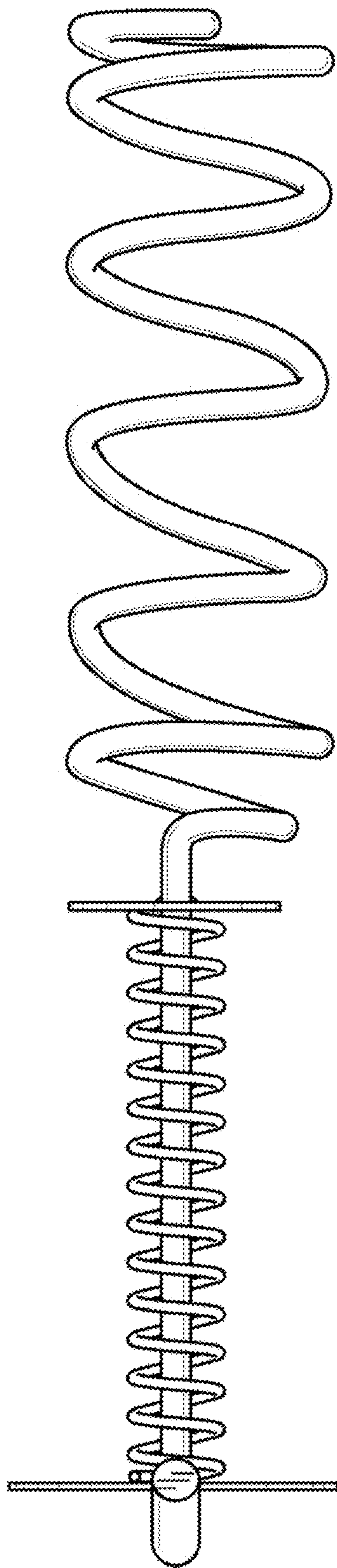

FIG. 4

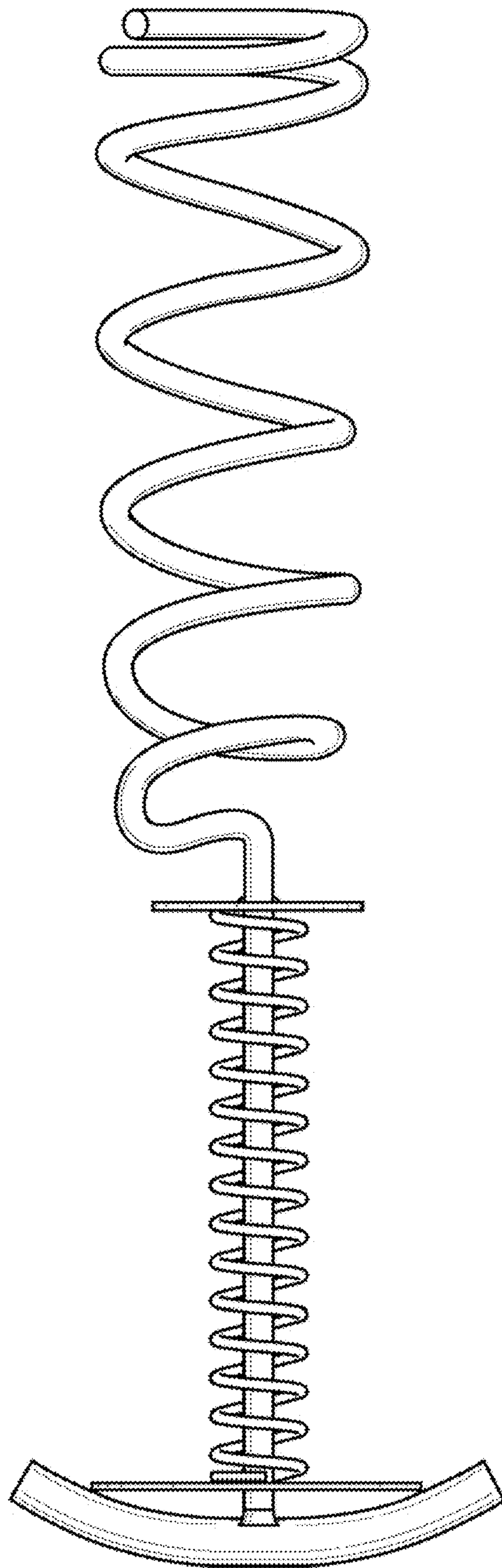

FIG. 5

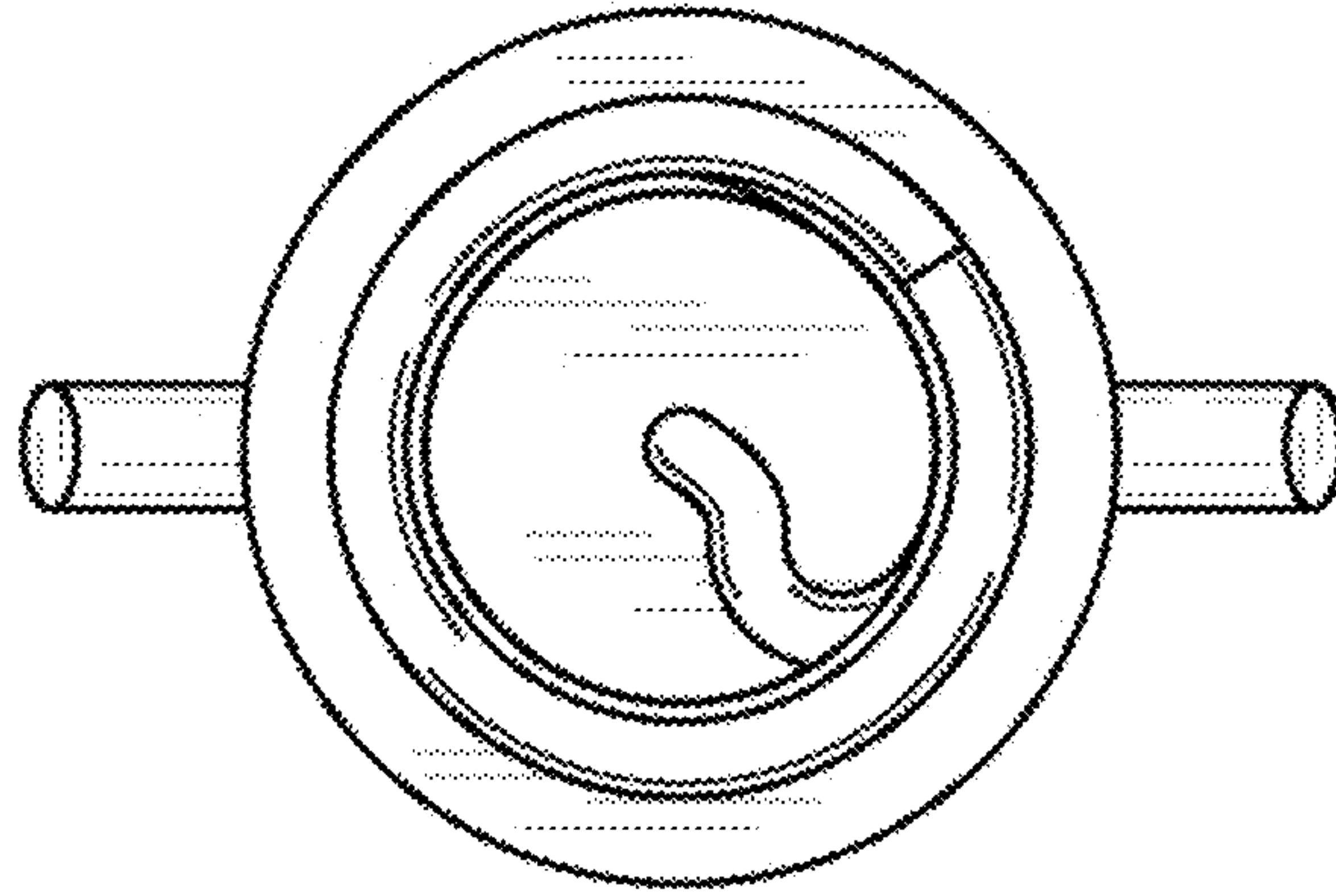

FIG. 6

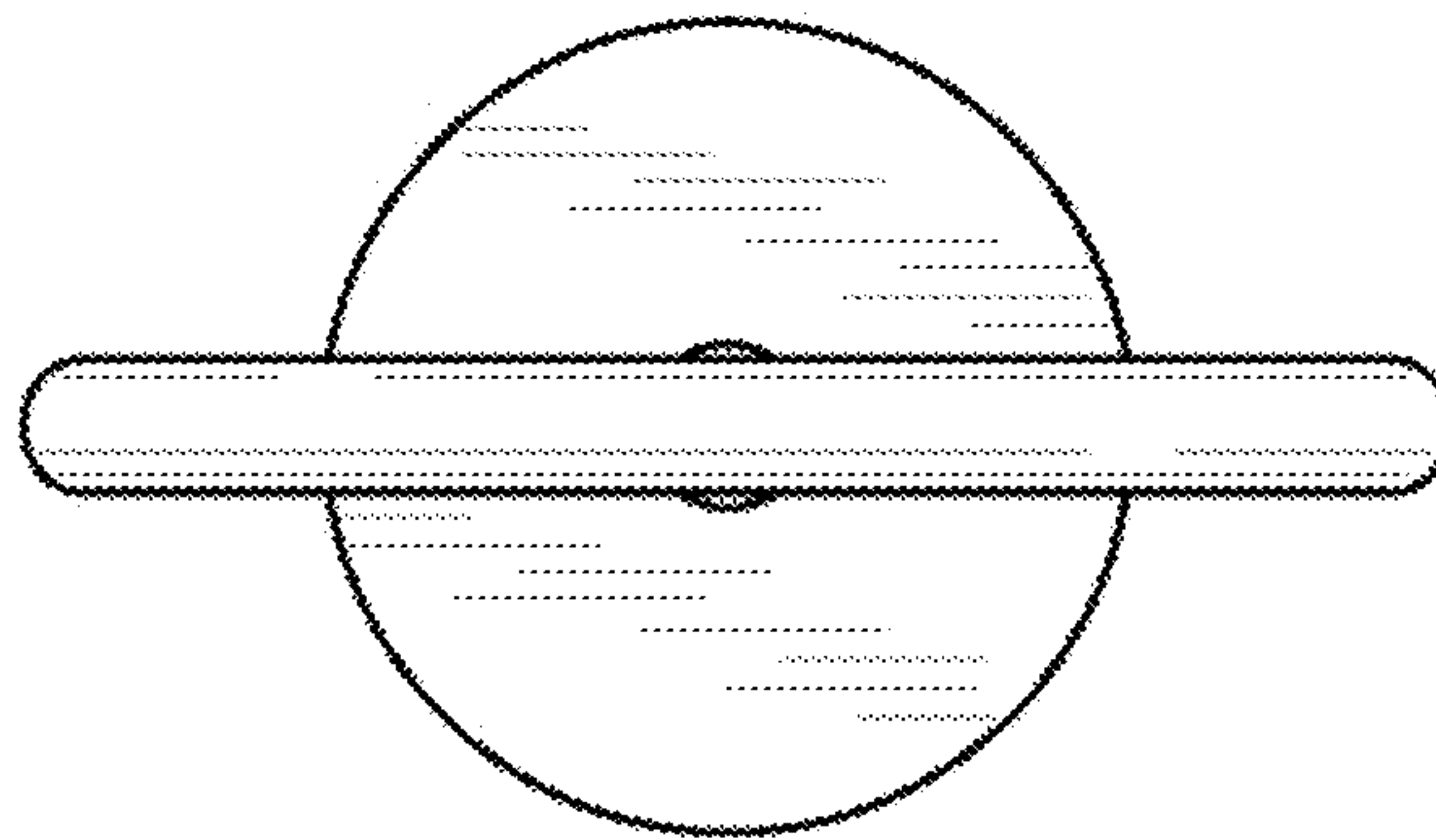

FIG. 7

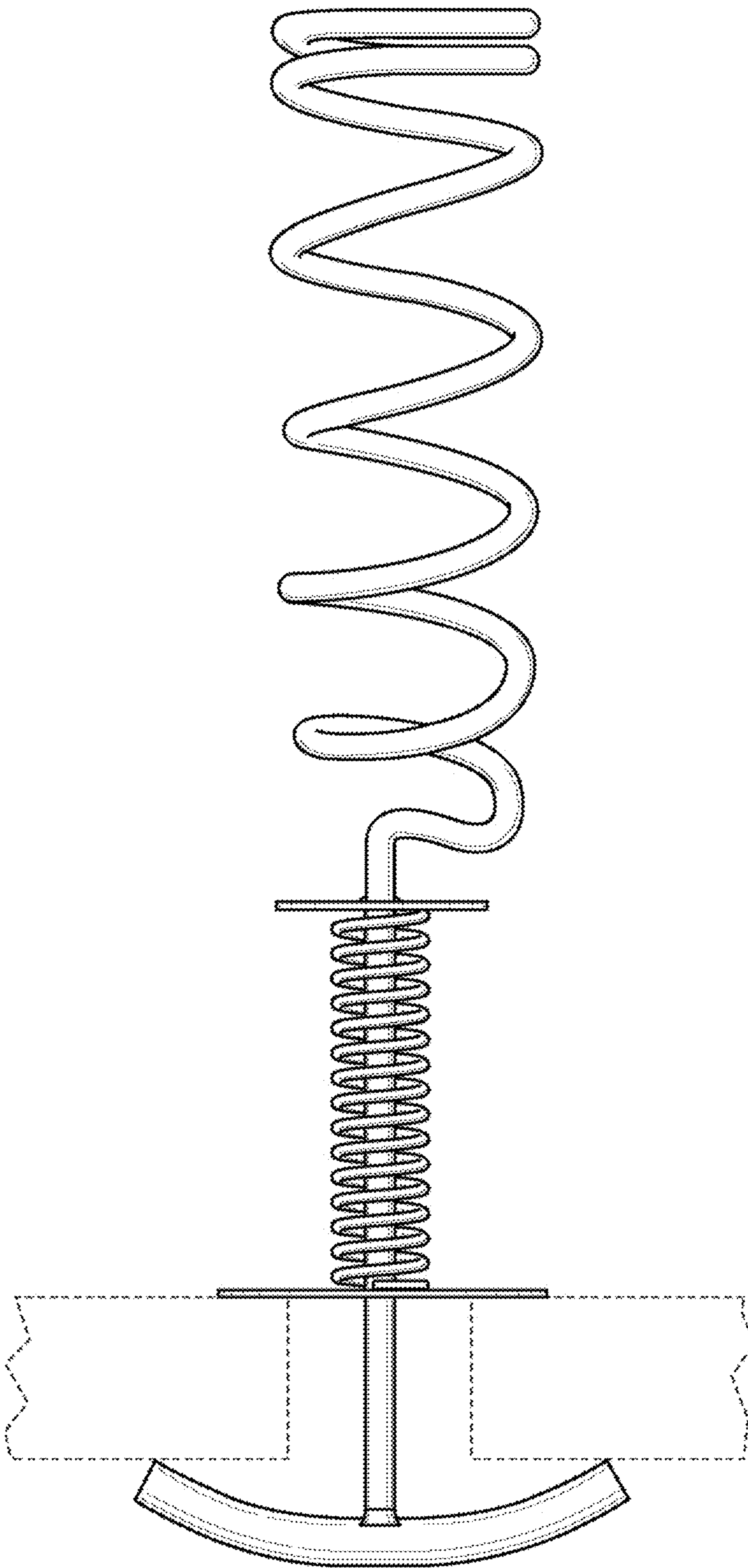

FIG. 8

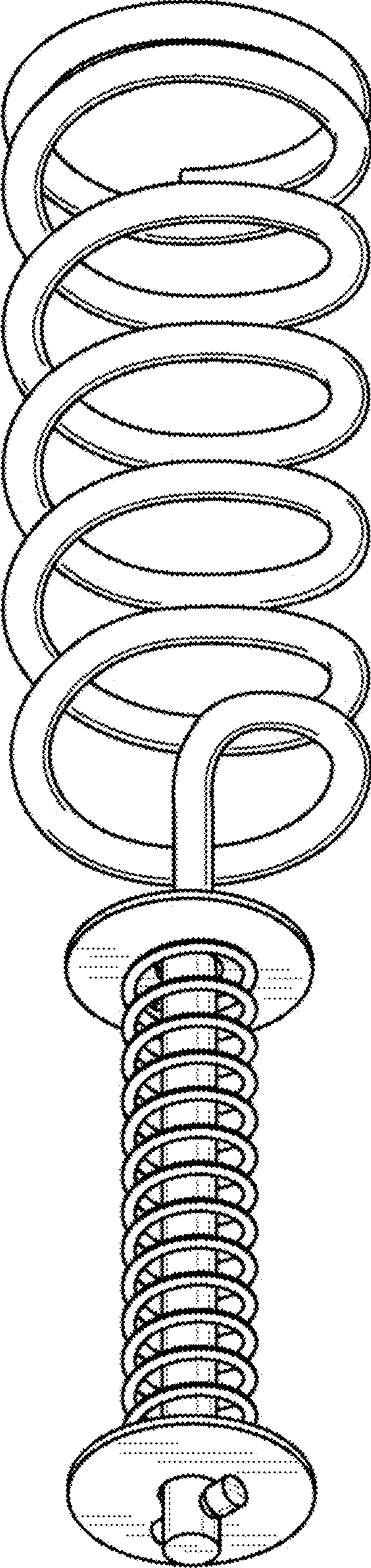

FIG. 9

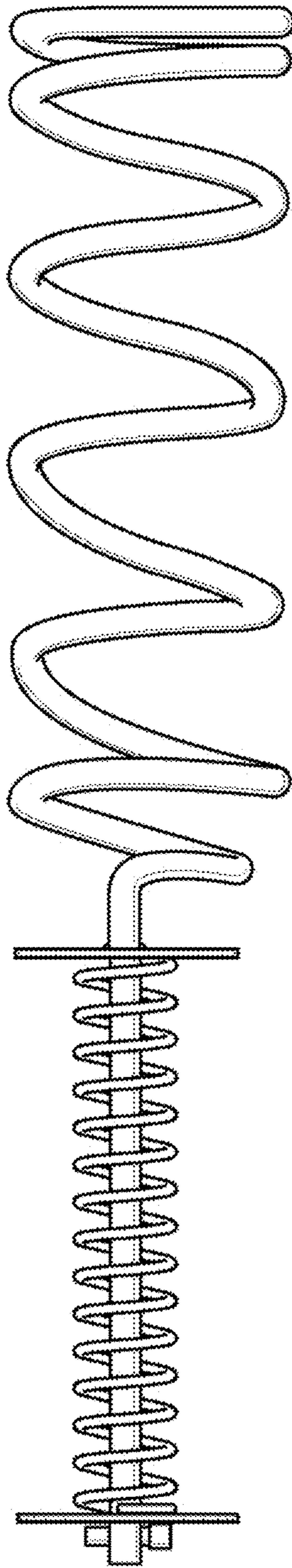

FIG. 10

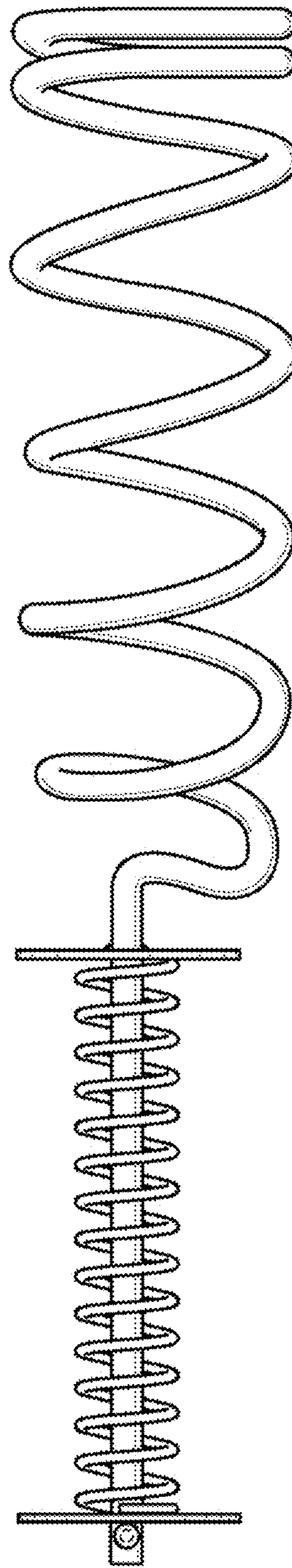

FIG. 11

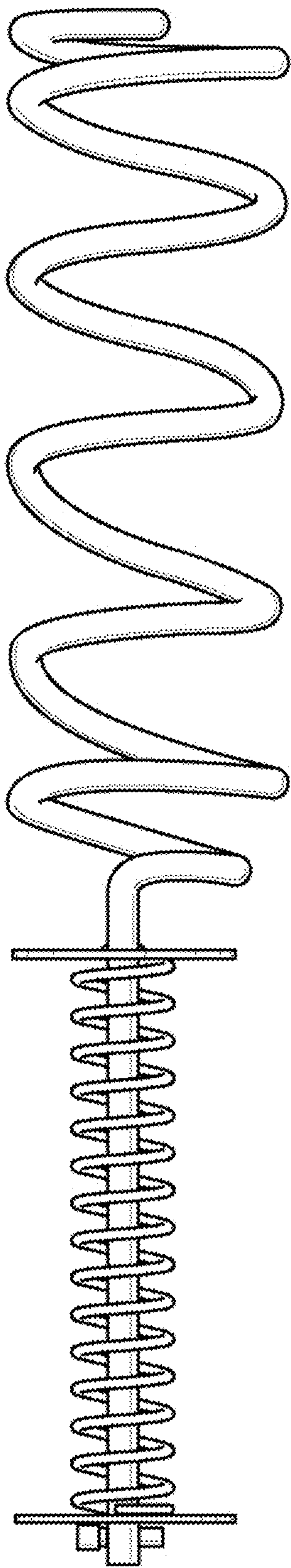

FIG. 12

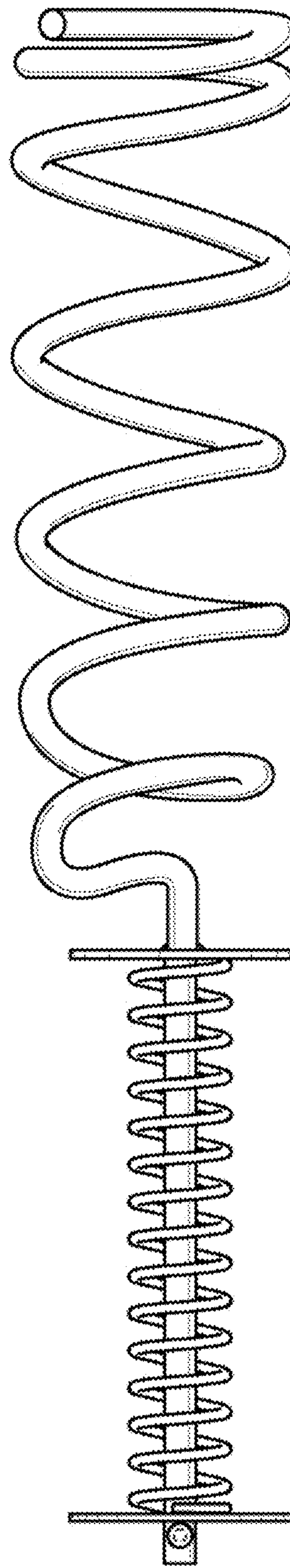

FIG. 13

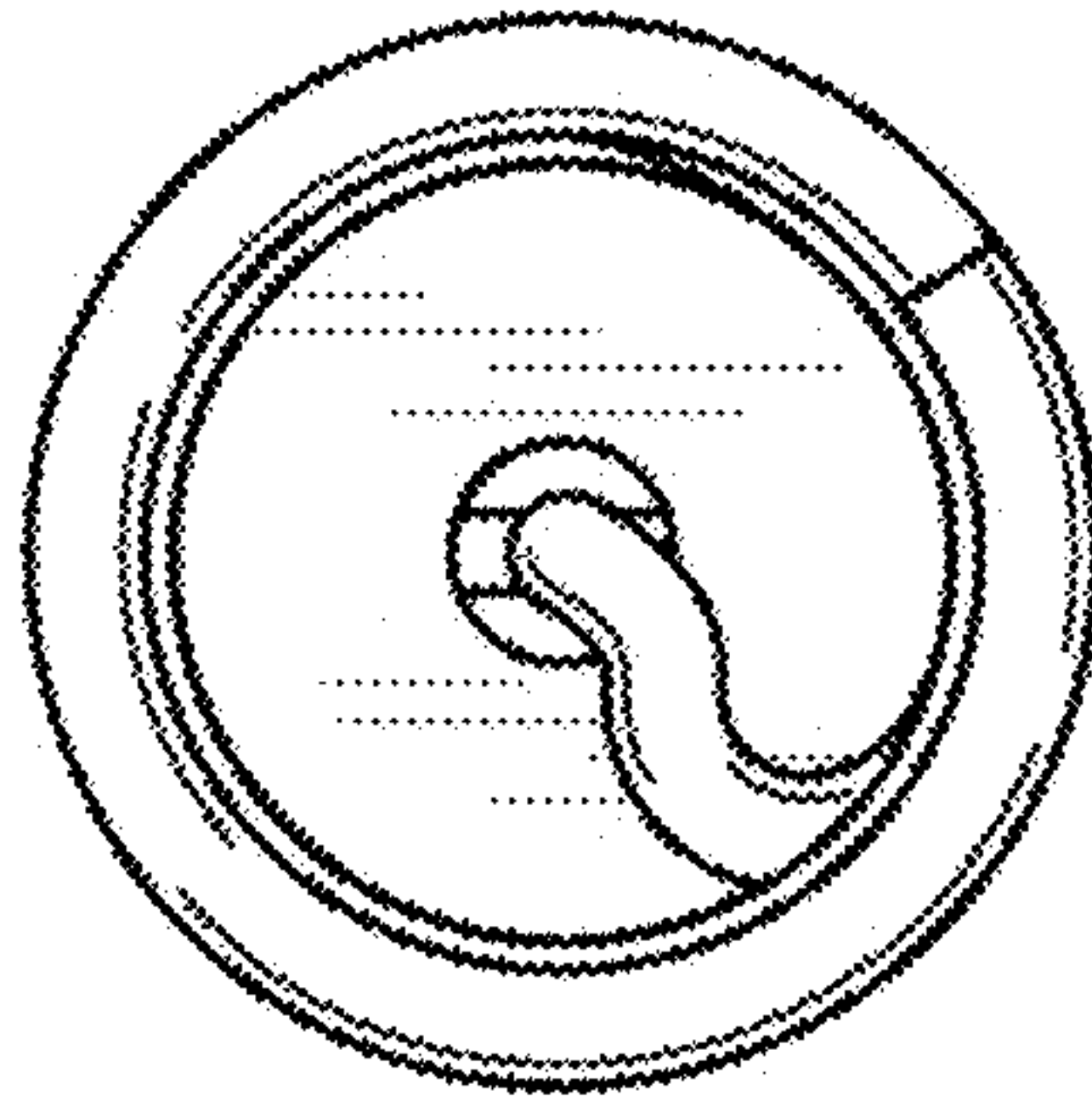

FIG. 14

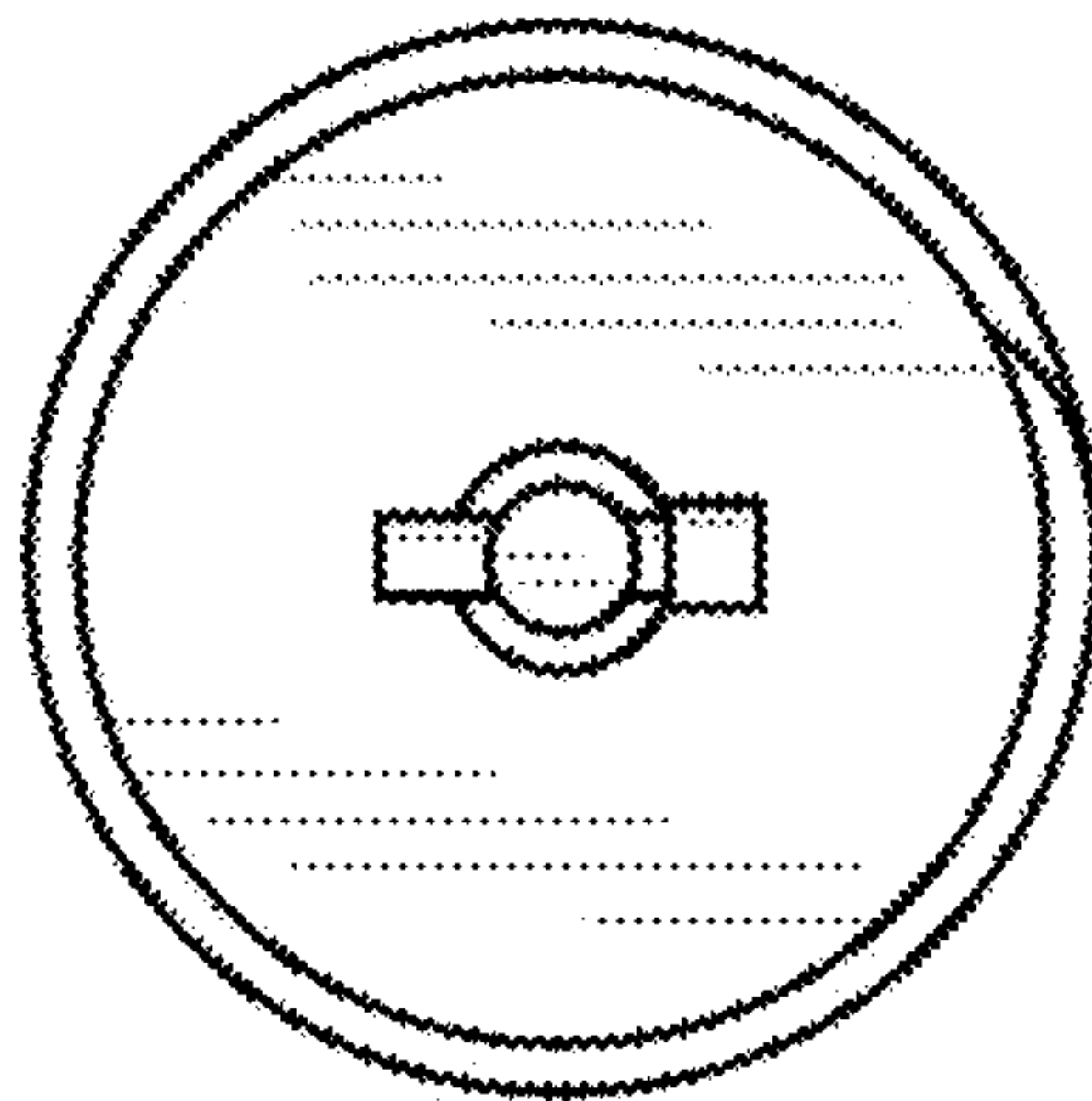

FIG. 15

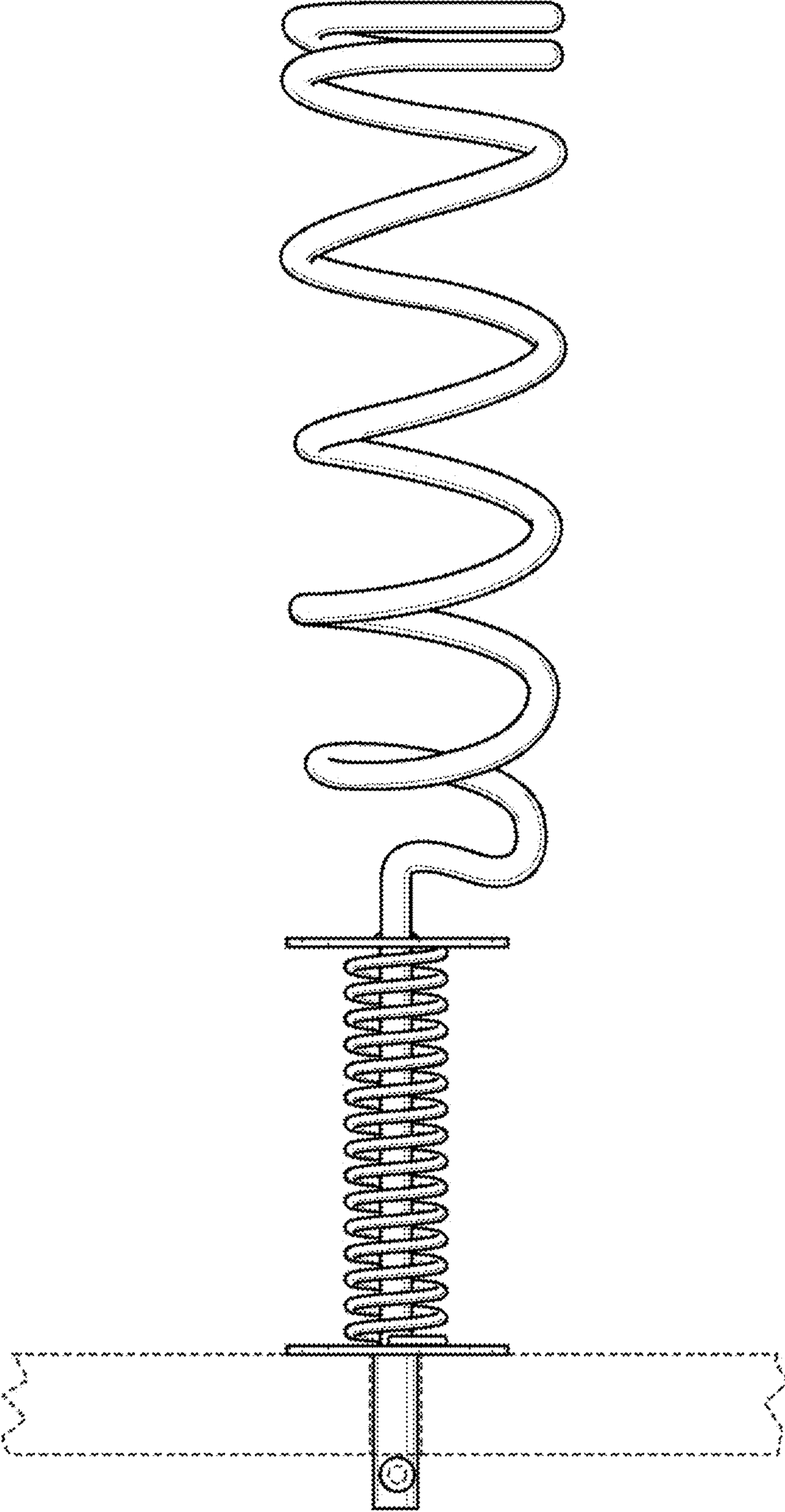

FIG. 16