



US00D886217S

(12) **United States Design Patent**
Chen

(10) **Patent No.:** **US D886,217 S**
(45) **Date of Patent:** **** Jun. 2, 2020**

(54) **EQUIPMENT FOR STRENGTHENING MUSCLES**

(71) Applicant: **SHENZHEN PUTAI ECOMMERCE CO., LTD.**, Shenzhen (CN)

(72) Inventor: **Junchao Chen**, Shenzhen (CN)

(73) Assignee: **SHENZHEN PUTAI ECOMMERCE CO., LTD.**, Shenzhen (CN)

(**) Term: **15 Years**

(21) Appl. No.: **29/721,730**

(22) Filed: **Jan. 23, 2020**

(51) **LOC (12) Cl.** **21-02**

(52) **U.S. Cl.**
USPC **D21/693**

(58) **Field of Classification Search**
USPC D21/693, 692, 684; 482/125, 91, 129, 482/126, 121, 112, 46, 128
CPC A63B 21/0552; A63B 21/0557; A63B 21/00069; A63B 21/4035; A63B 21/0442; A63B 21/023; A63B 21/00043; A63B 21/0004; A63B 21/0428; A63B 21/05; A63B 21/045

See application file for complete search history.

(56) **References Cited**

U.S. PATENT DOCUMENTS

- 1,495,278 A * 5/1924 Titus A63B 21/0004 482/49
- 1,620,910 A * 3/1927 Minnich A63B 21/0004 482/126
- 1,660,234 A * 2/1928 Pezuto A63B 21/0004 482/125
- 1,832,633 A * 11/1931 Hendrickson, Jr. A63B 21/0004 482/126
- 1,885,473 A * 11/1932 Pat A63B 21/0004 482/129

- 3,204,955 A * 9/1965 Quire A63B 21/0004 482/91
- 3,445,109 A * 5/1969 Kolbel A63B 21/05 482/125
- 3,544,106 A * 12/1970 Barrett A63B 21/05 482/126
- 3,592,467 A * 7/1971 Pereira A63B 21/0004 482/126

(Continued)

Primary Examiner — Ryan Harvey

(57) **CLAIM**

The ornamental design for an equipment for strengthening muscles, as shown and described.

DESCRIPTION

FIG. 1 is a perspective view of an equipment for strengthening muscles showing my new design;
 FIG. 2 is another perspective view thereof;
 FIG. 3 is a front elevational view thereof;
 FIG. 4 is a rear elevational view thereof;
 FIG. 5 is a left side elevational view thereof;
 FIG. 6 is a right side elevational view thereof;
 FIG. 7 is a top plan view thereof;
 FIG. 8 is a bottom plan view thereof;
 FIG. 9 is a perspective view of the equipment for strengthening muscles where the equipment for strengthening muscles is in a configuration of use;
 FIG. 10 is a front elevational view of the equipment for strengthening muscles where the equipment for strengthening muscles is in the configuration of use;
 FIG. 11 is an enlarged view of portion 11 shown in FIG. 1;
 FIG. 12 is an enlarged view of portion 12 shown in FIG. 1; and,
 FIG. 13 is an enlarged view of portion 13 shown in FIG. 2.
 The broken lines in the drawings depict portions of the equipment for strengthening muscles that form no part of the claimed design.

1 Claim, 13 Drawing Sheets

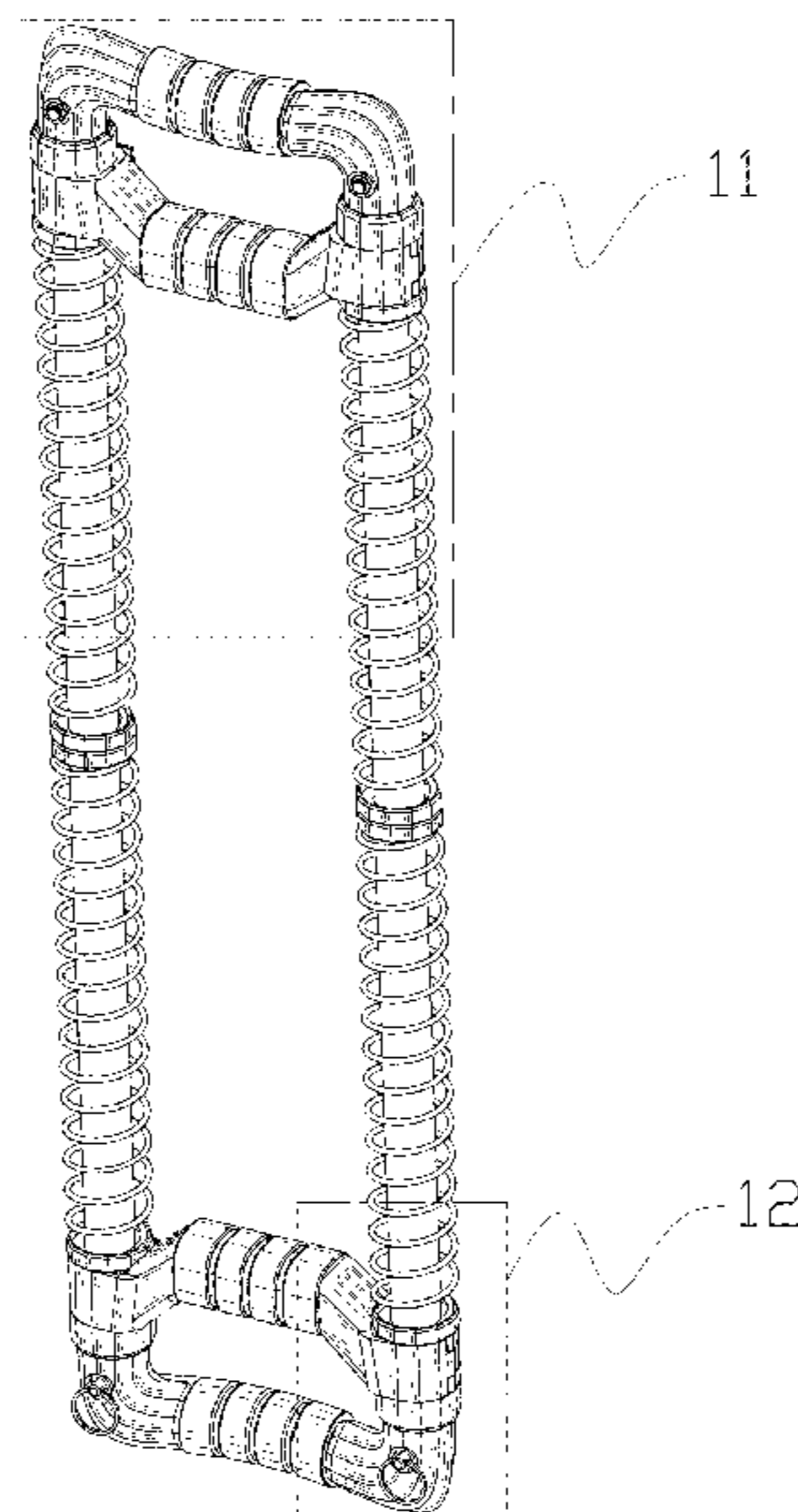

(56)

References Cited

U.S. PATENT DOCUMENTS

3,761,083 A * 9/1973 Buchner A63B 21/05
482/126
D232,368 S * 8/1974 Shales D21/692
D242,936 S * 1/1977 Docic D21/693
4,239,212 A * 12/1980 Hickey A63B 21/00043
482/126
4,248,421 A * 2/1981 Salazar A63B 21/0085
482/112
D263,328 S 3/1982 Cooper
4,406,453 A * 9/1983 Herzfeld A63B 21/0004
482/126
4,489,937 A * 12/1984 Kong A63B 21/00043
482/126
D278,667 S * 5/1985 Jacobson D21/692
D288,108 S * 2/1987 Hata D21/693
D288,460 S * 2/1987 Hsu D21/693
D300,338 S * 3/1989 Kunio D21/684
4,865,317 A * 9/1989 Hickey A63B 21/05
482/126
D305,678 S * 1/1990 Kunio D21/684
5,031,906 A 7/1991 Jang
D330,739 S * 11/1992 Yang D21/693
D353,859 S * 12/1994 Grey D21/684
5,397,288 A * 3/1995 Sayre A63B 21/018
482/122
5,569,125 A * 10/1996 Clementi A63B 21/045
482/126
5,611,755 A * 3/1997 Blackmore A63B 23/16
482/126
5,643,158 A * 7/1997 Clementi A63B 21/00043
482/121
5,735,780 A * 4/1998 Fazio A63B 21/00072
482/112

D409,816 S * 5/1999 Young D21/692
D420,072 S * 2/2000 Hershey D21/684
D438,266 S * 2/2001 Levrett D21/684
D441,413 S * 5/2001 Cataldi, Jr. D21/662
D446,561 S * 8/2001 Beard D21/662
D446,832 S * 8/2001 Chen D21/692
D456,471 S * 4/2002 Rankin D21/692
6,390,959 B1 * 5/2002 Tornabene A63B 21/00043
482/122
D458,322 S * 6/2002 Rankin D21/692
D460,795 S * 7/2002 Fitzpatrick D21/662
D470,201 S * 2/2003 Paul D21/684
D500,101 S * 12/2004 Fitzgerald D21/684
7,163,495 B2 * 1/2007 Fazio A63B 21/0004
482/111
D635,207 S * 3/2011 Dalebout D21/692
D660,929 S * 5/2012 Fitzpatrick D21/692
8,602,951 B2 * 12/2013 Morris A63B 21/0004
403/202
8,747,286 B1 * 6/2014 Simon A63B 21/05
482/128
9,254,408 B1 * 2/2016 Otto A63B 21/055
D757,870 S * 5/2016 Leslie D21/693
D879,219 S * 3/2020 Chen D21/692
2010/0069207 A1 * 3/2010 Ko A63B 21/0004
482/126
2011/0092346 A1 * 4/2011 Wakuda A63B 21/0004
482/121
2011/0269607 A1 * 11/2011 Choi A63B 21/0004
482/126
2015/0196791 A1 * 7/2015 Yu A63B 22/20
482/139
2019/0015696 A1 * 1/2019 Porterfield A63B 21/4035
2019/0175973 A1 6/2019 An

* cited by examiner

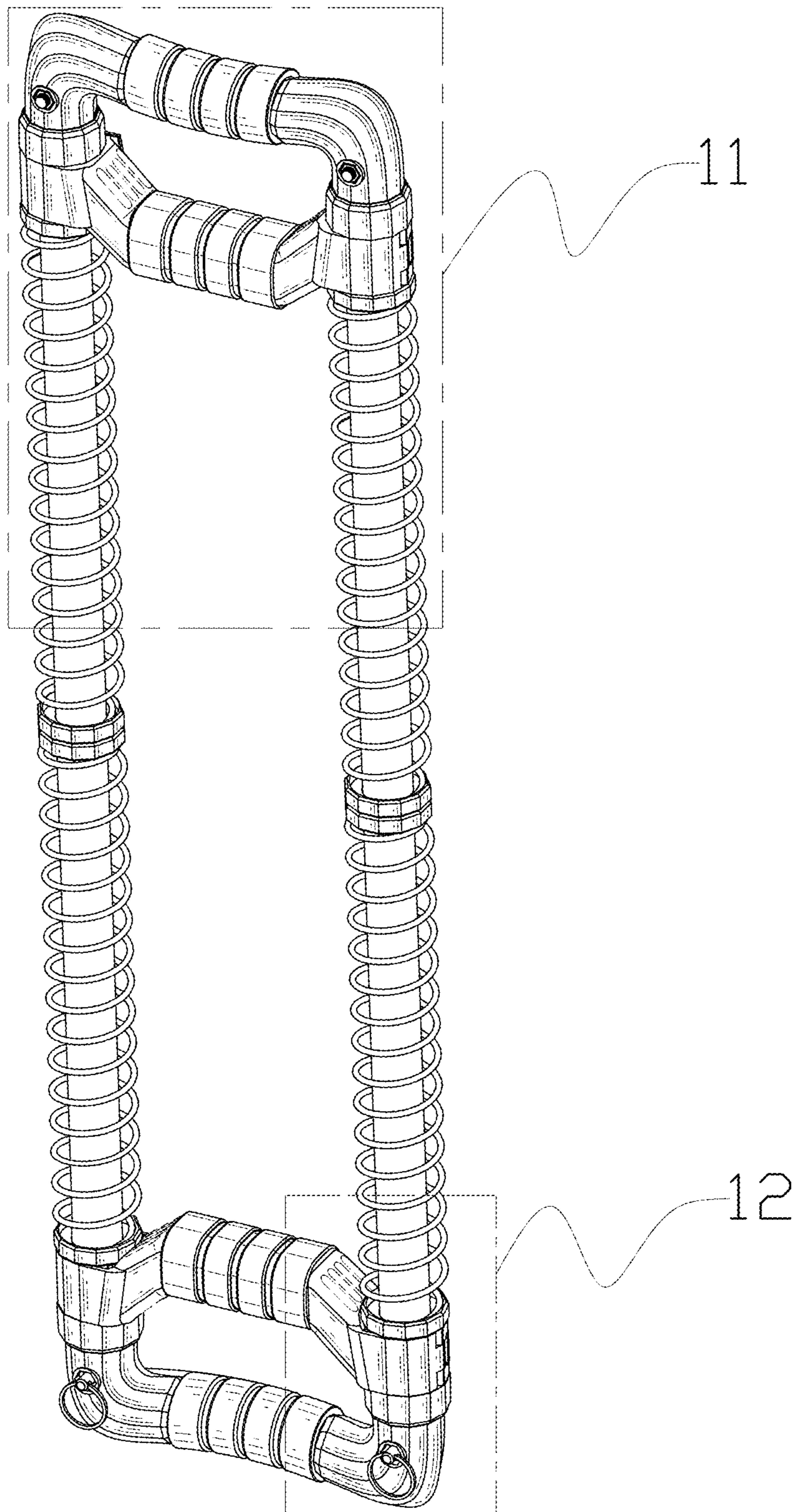

FIG. 1

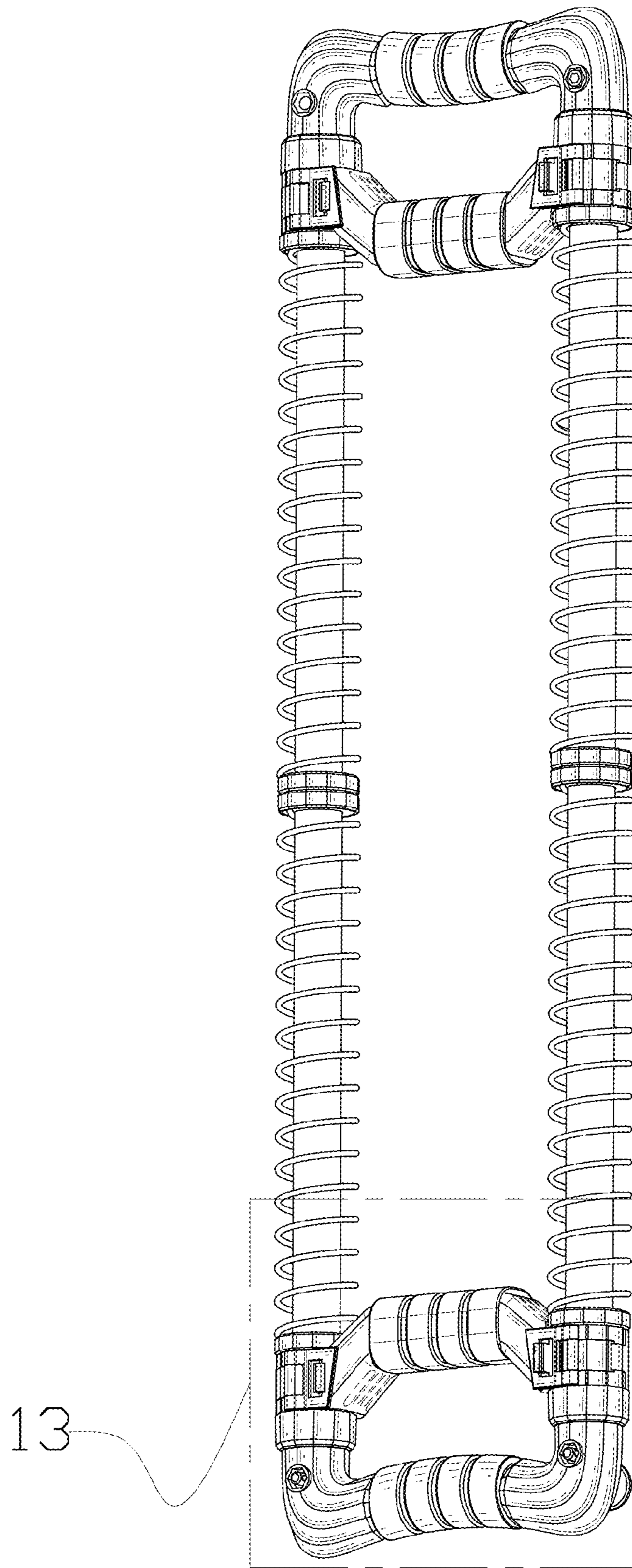

FIG. 2

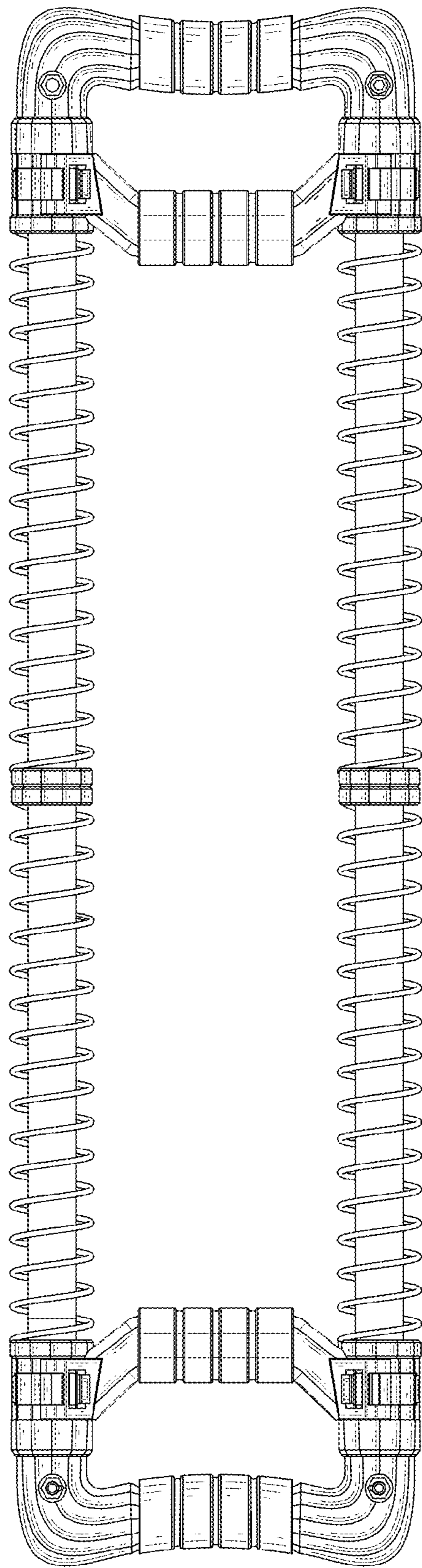

FIG. 3

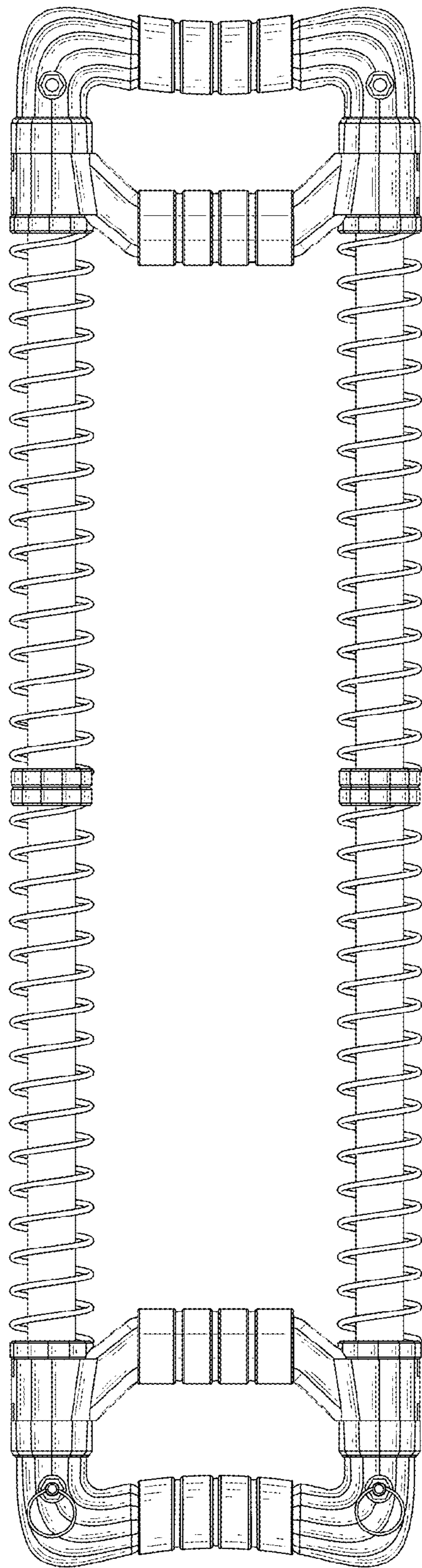

FIG. 4

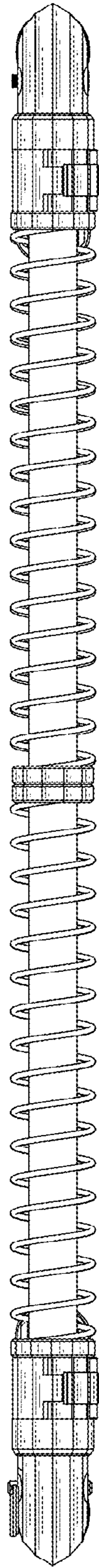

FIG. 5

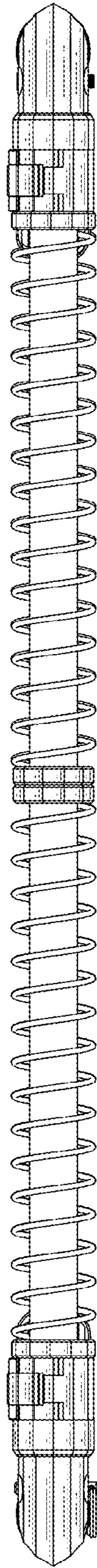

FIG. 6

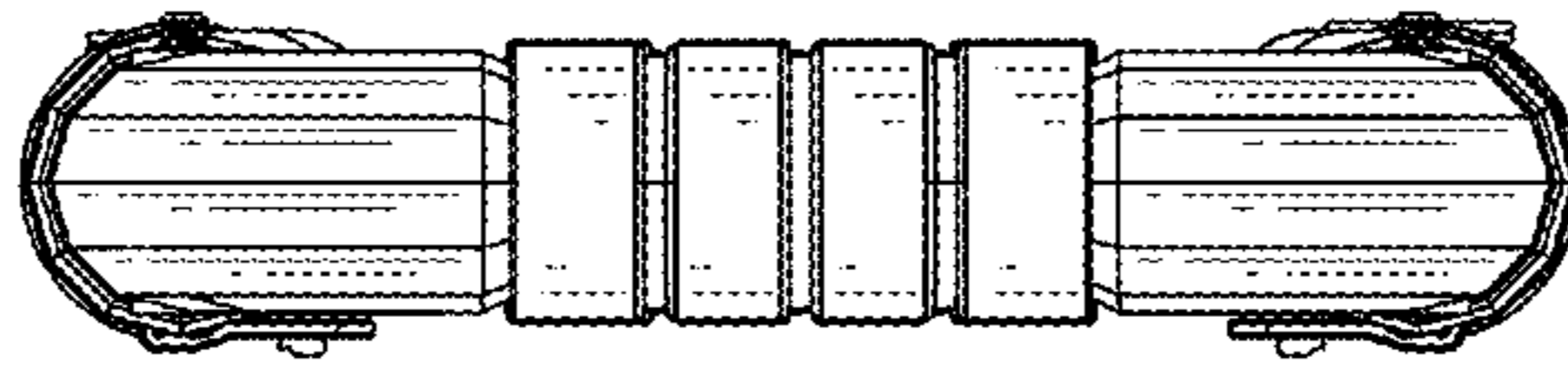

FIG. 7

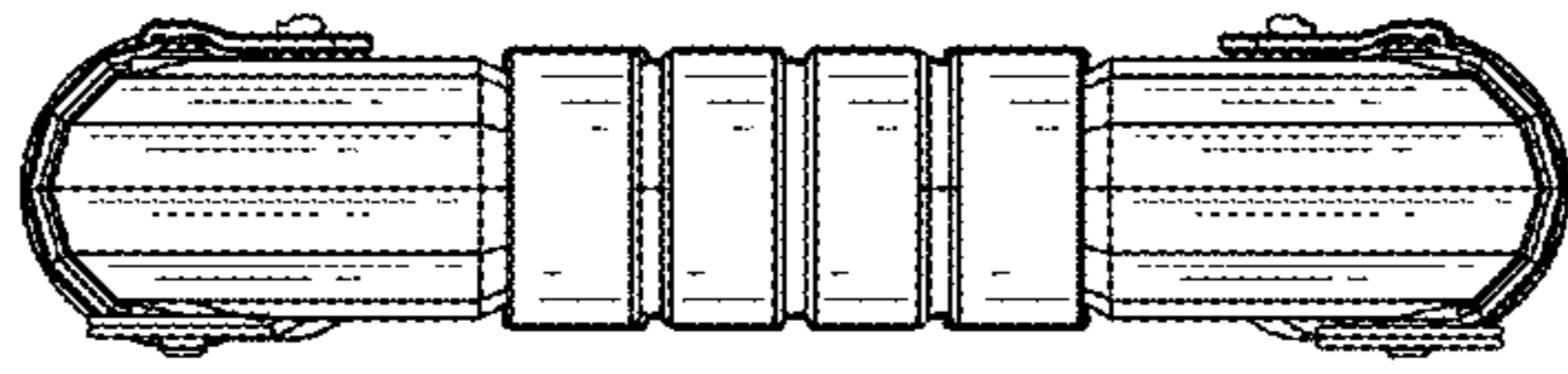

FIG. 8

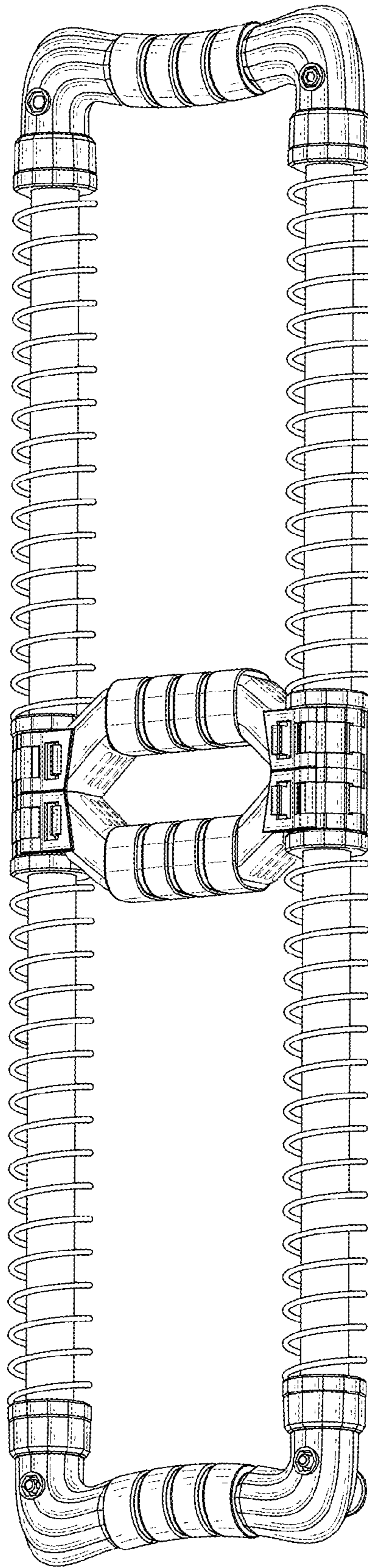

FIG. 9

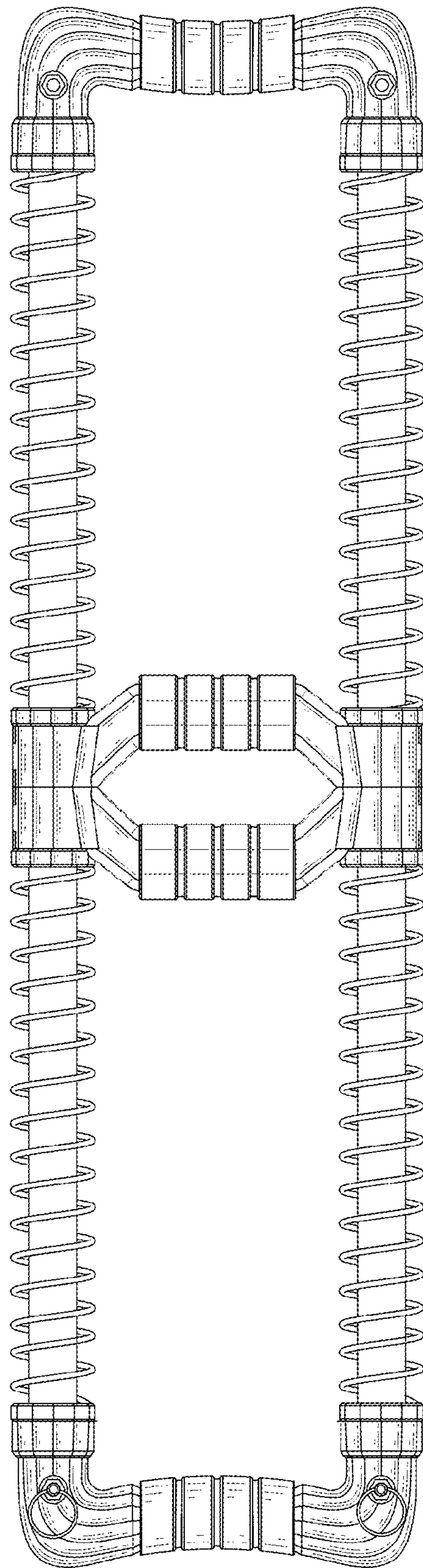

FIG. 10

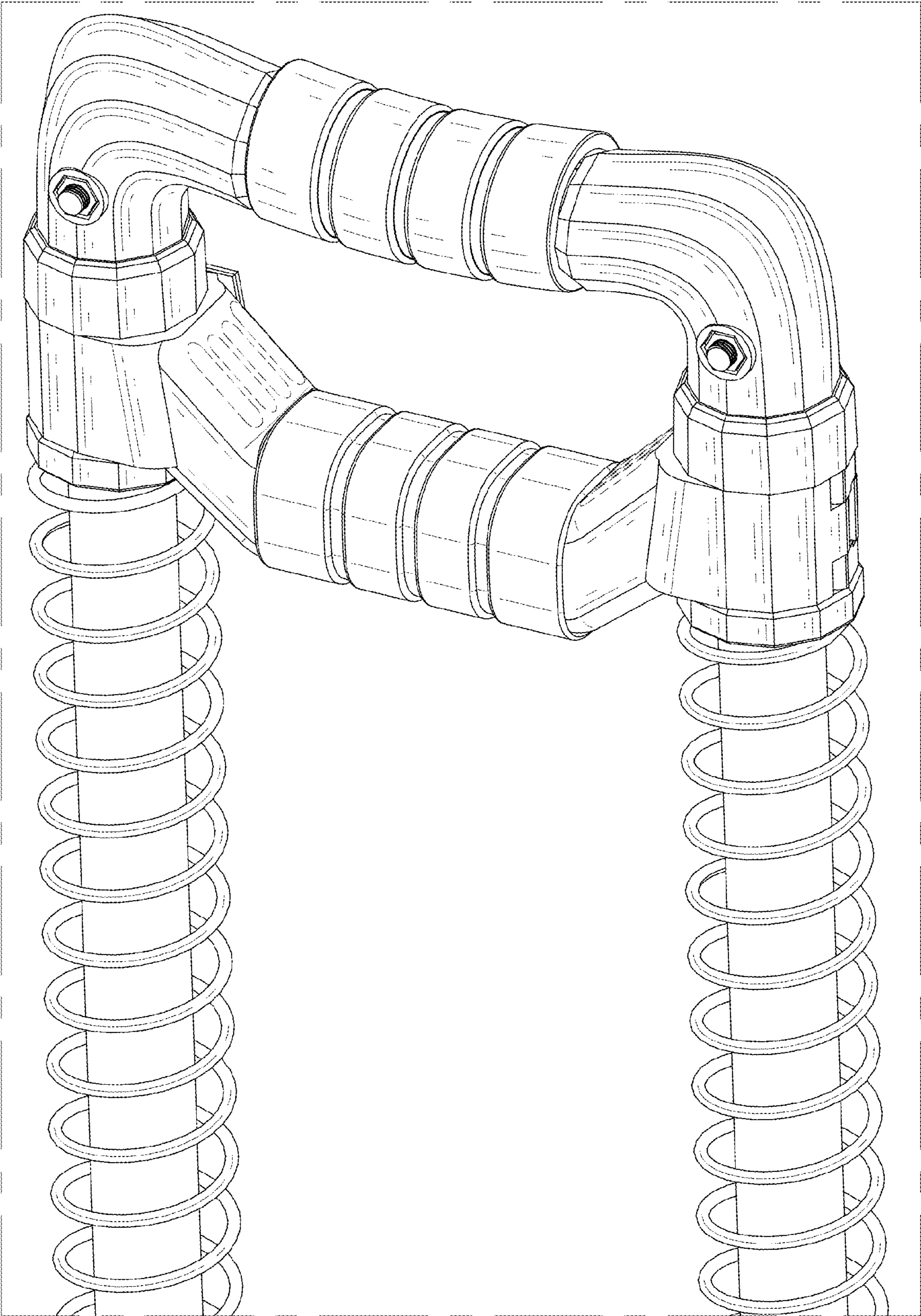

FIG. 11

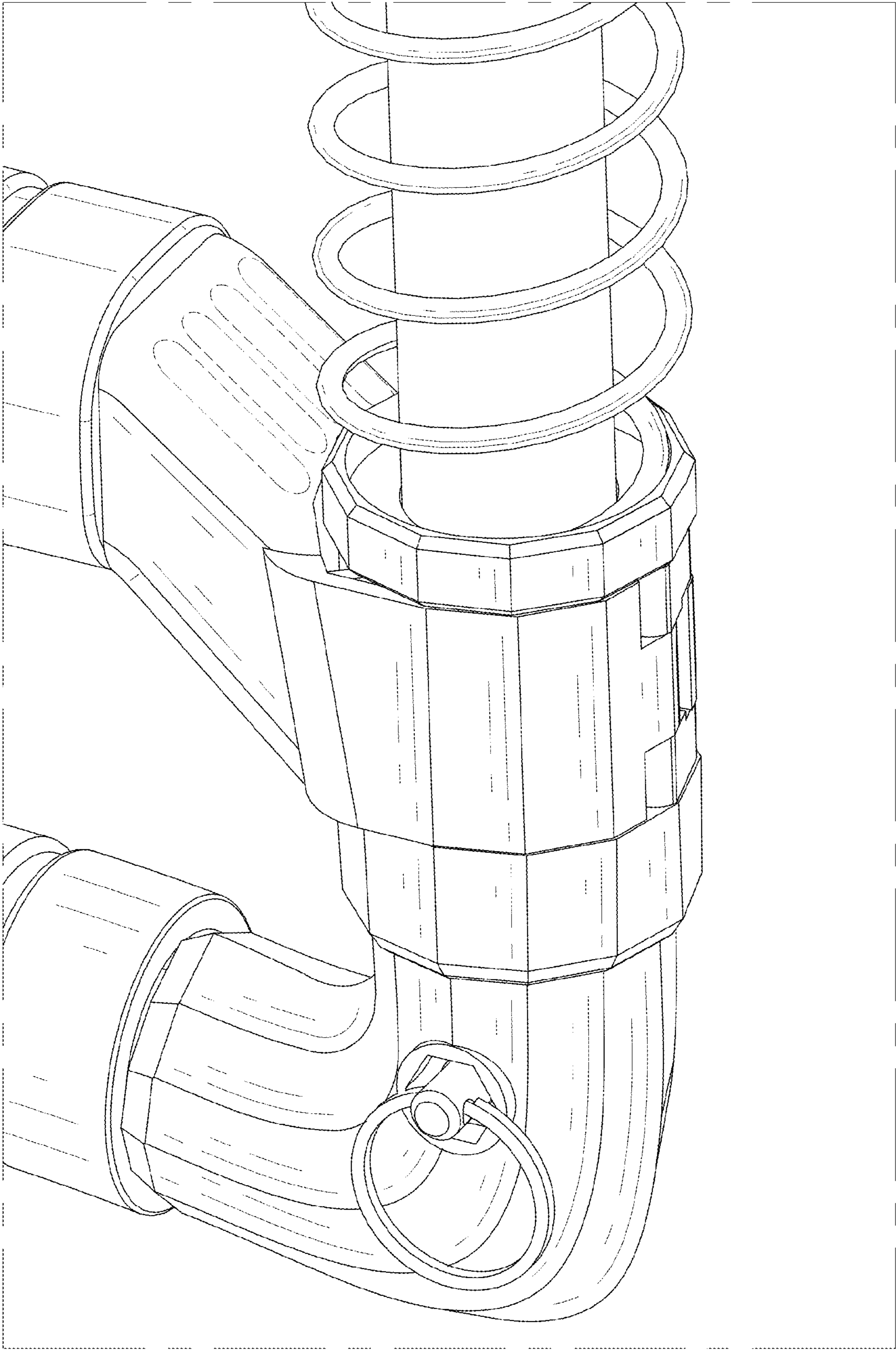

FIG. 12

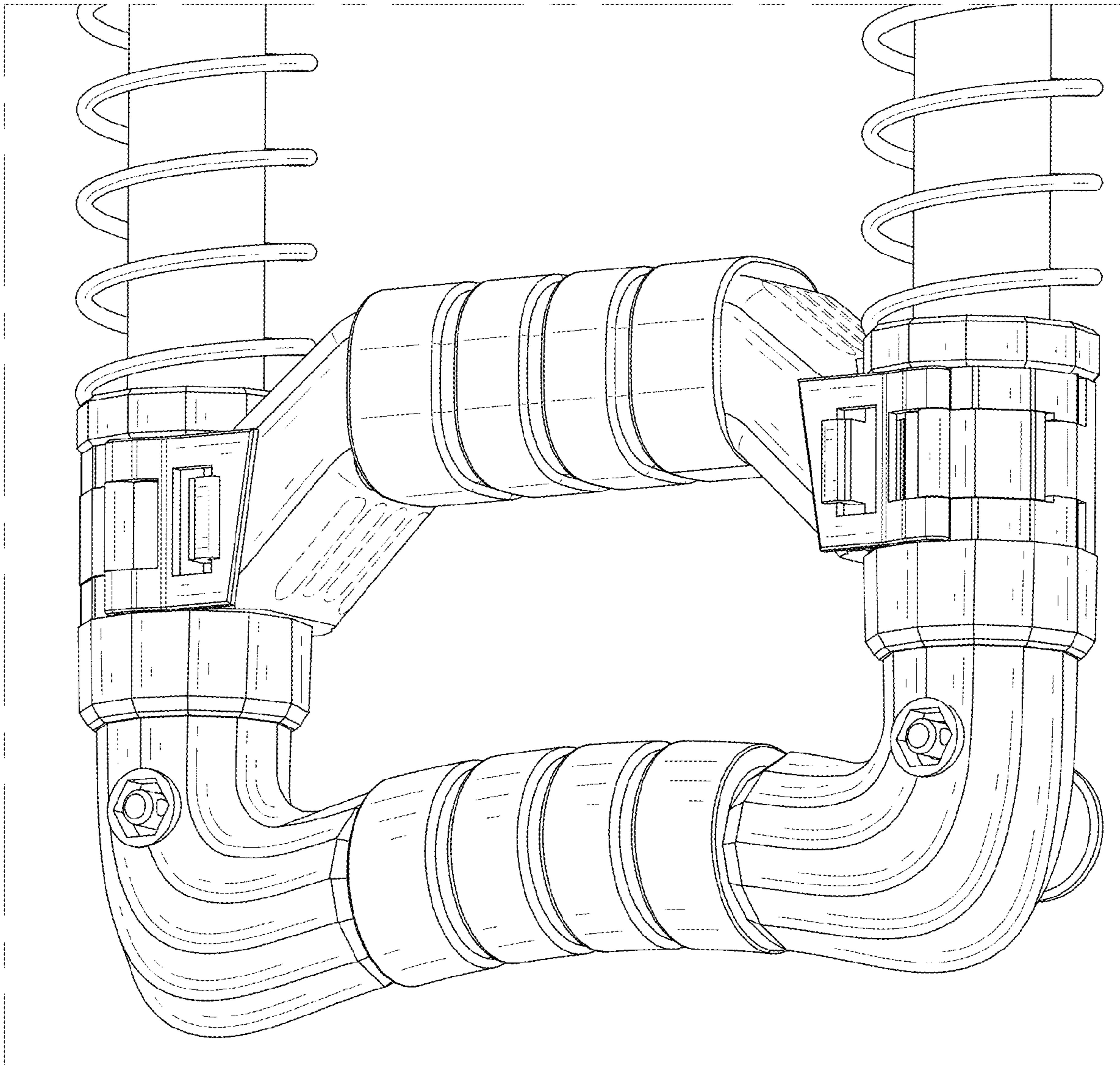

FIG. 13