



US00D886052S

(12) **United States Design Patent**
Albay et al.

(10) **Patent No.:** **US D886,052 S**
(45) **Date of Patent:** **** Jun. 2, 2020**

(54) **CHARGER FOR ELECTRIC TOOTHBRUSH**

(71) Applicant: **Braun GmbH**, Kronberg (DE)
(72) Inventors: **Devran Albay**, Frankfurt (DE); **Moritz Carlo Honisch**, Frankfurt (DE); **Dominik Langhammer**, Frankfurt (DE); **Fritz Schubert**, Bad Camberg (DE)

(73) Assignee: **BRAUN GMBH**, Kronberg (DE)

(**) Term: **15 Years**

(21) Appl. No.: **29/641,349**

(22) Filed: **Mar. 21, 2018**

(30) **Foreign Application Priority Data**

Sep. 21, 2017 (WO) 4801501

(51) **LOC (12) Cl.** **13-02**

(52) **U.S. Cl.**
USPC **D13/108**

(58) **Field of Classification Search**
USPC D13/107-110, 118-119, 184; D14/251, D14/253, 432, 434
CPC Y02E 60/12; Y02T 90/14; Y02T 90/122; Y02T 90/128; Y02T 90/163; H02J 7/025; H02J 7/0042; H02J 7/0044; H02J 7/0045; H02J 7/0003; H01F 38/14; H01R 13/6675; H01M 2/1022; H01M 2/1055; H01M 10/44; H01M 10/46; H01M 10/425; B60L 11/182
See application file for complete search history.

(56) **References Cited**

U.S. PATENT DOCUMENTS

D454,695 S * 3/2002 Greene D13/108
D548,179 S * 8/2007 Vu D13/108

D578,475 S * 10/2008 Beedham D13/108
D628,991 S * 12/2010 Chung D14/224
D628,992 S * 12/2010 Chung D14/224
D682,198 S * 5/2013 Vu D13/108
D768,570 S * 10/2016 Shigeno D13/108
D768,571 S * 10/2016 Shigeno D13/108
D836,547 S * 12/2018 Uttley D13/108
D870,663 S * 12/2019 Schubert D13/108
D870,664 S * 12/2019 Langhammer D13/108
D870,665 S * 12/2019 Schubert D13/108
2017/0119510 A1 * 5/2017 Tomori A61C 17/224

* cited by examiner

Primary Examiner — Nathaniel D. Buckner

(74) *Attorney, Agent, or Firm* — Vladimir Vitenberg

(57) **CLAIM**

The ornamental design for a charger for electric toothbrush, as shown and described.

DESCRIPTION

FIG. 1 is a perspective view of a first embodiment of a charger for electric toothbrush;
FIG. 2 is a front view thereof;
FIG. 3 is a right-side view thereof;
FIG. 4 is a rear view thereof;
FIG. 5 is a left-side view thereof;
FIG. 6 is a top-plan view thereof;
FIG. 7 is a bottom view thereof.
FIG. 8 is a perspective view of a second embodiment of a charger for electric toothbrush;
FIG. 9 is a front view thereof;
FIG. 10 is a right-side view thereof;
FIG. 11 is a rear view thereof;
FIG. 12 is a left-side view thereof;
FIG. 13 is a top-plan view thereof; and,
FIG. 14 is a bottom view thereof.

1 Claim, 14 Drawing Sheets

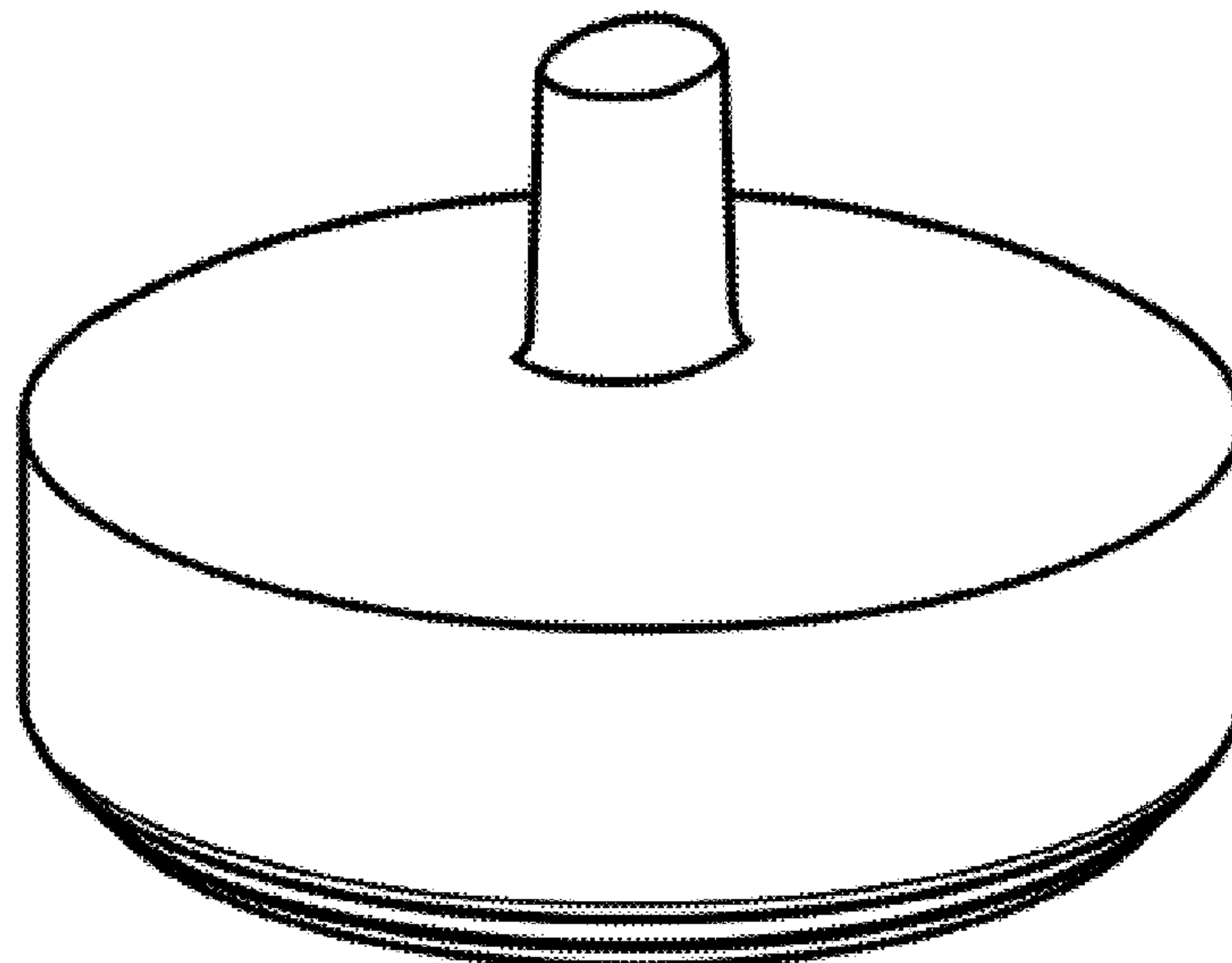

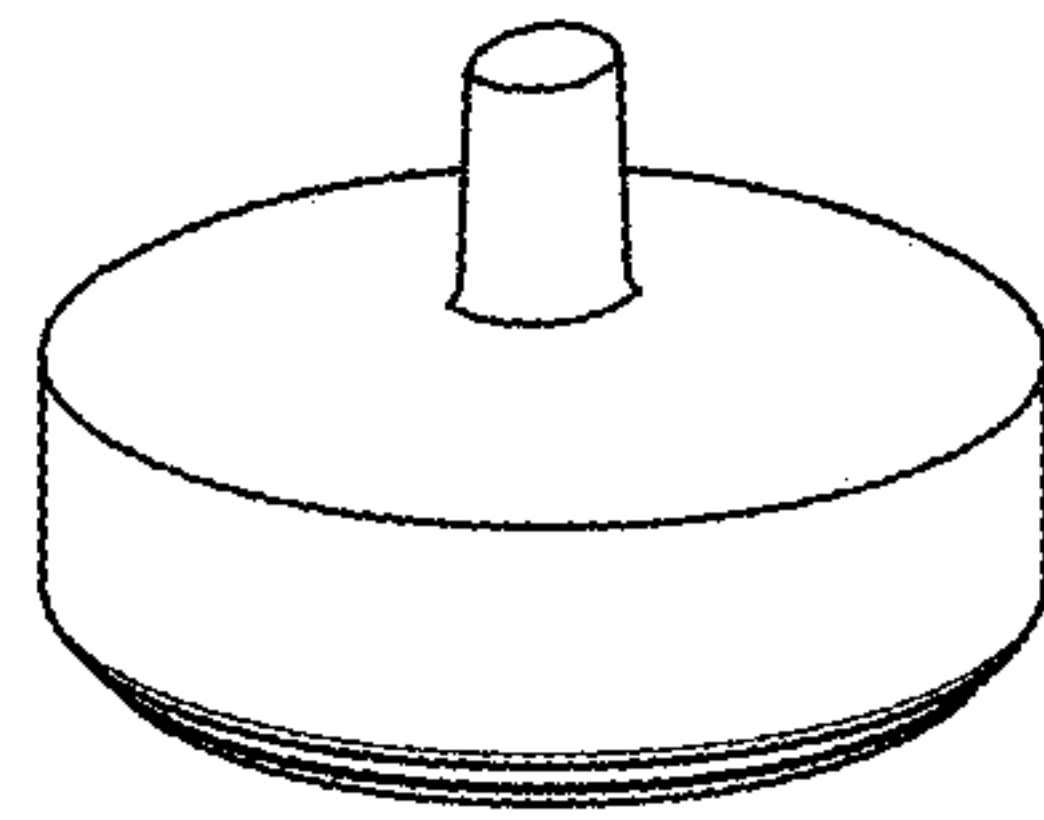

Figure 1

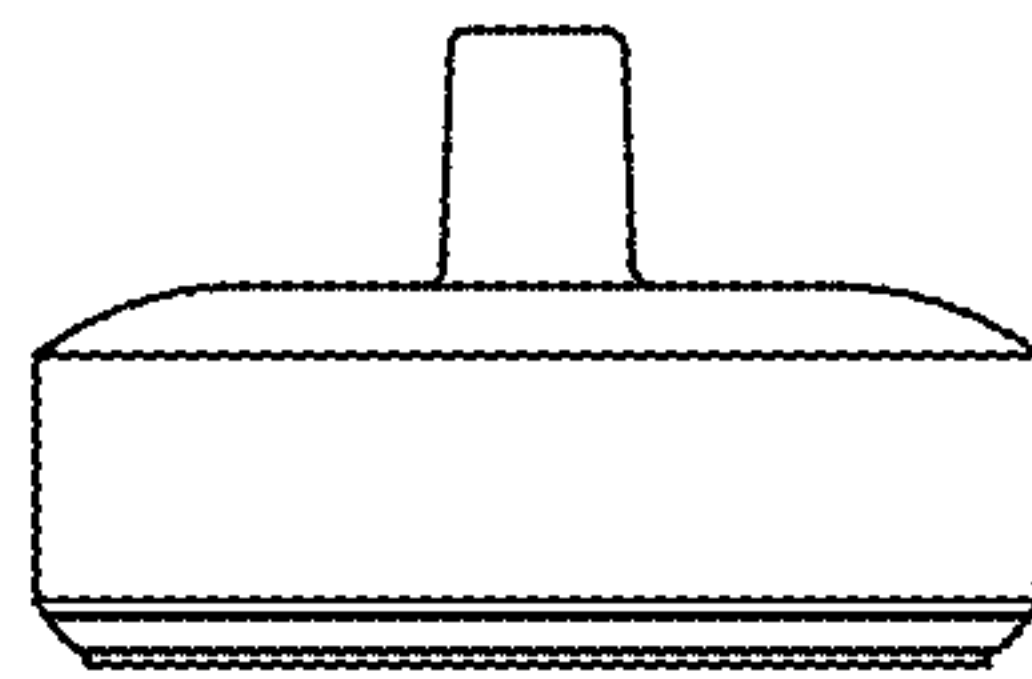

Figure 2

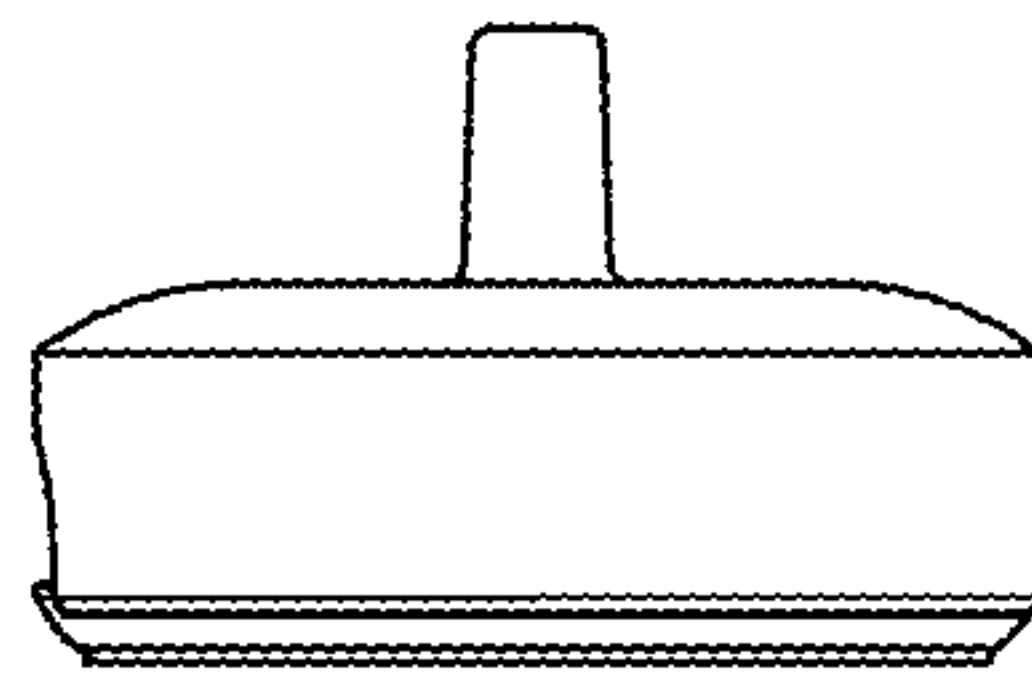

Figure 3

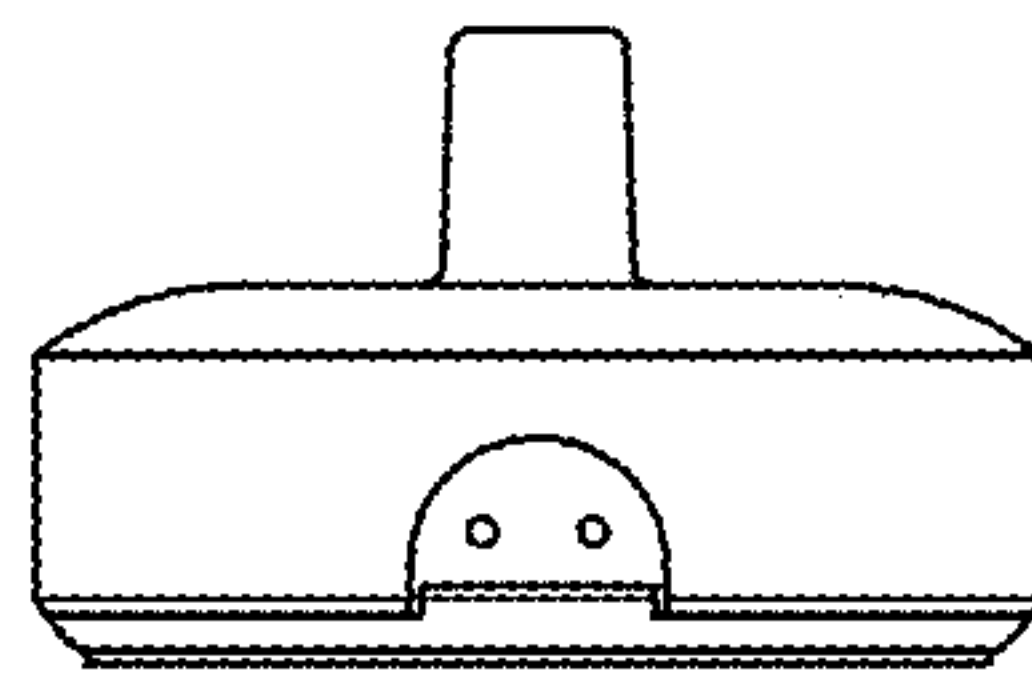

Figure 4

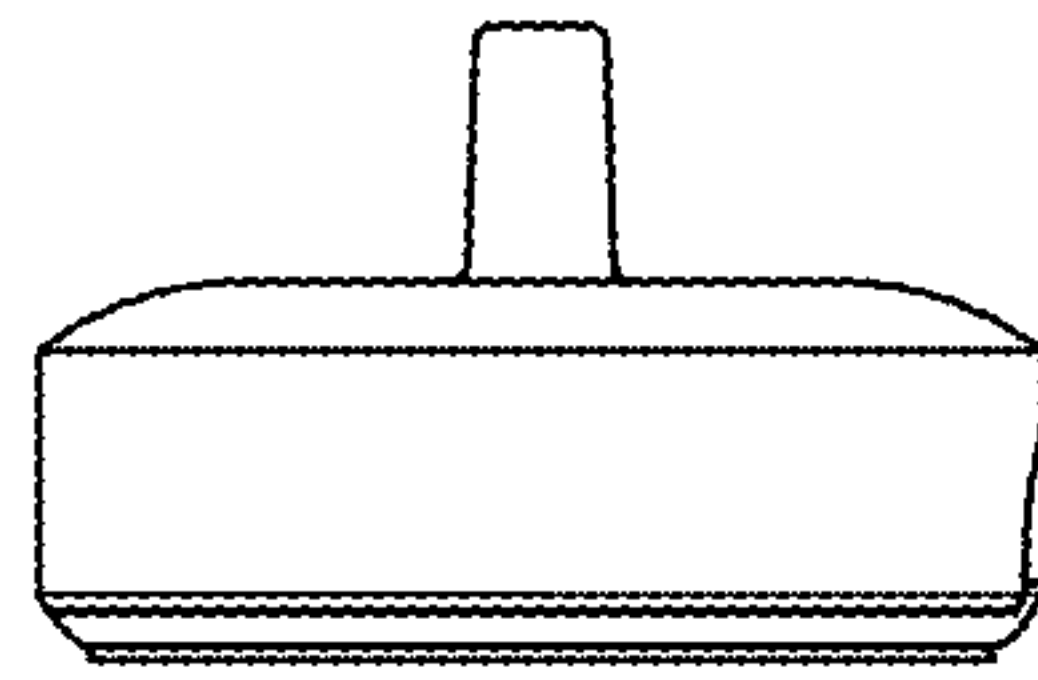

Figure 5

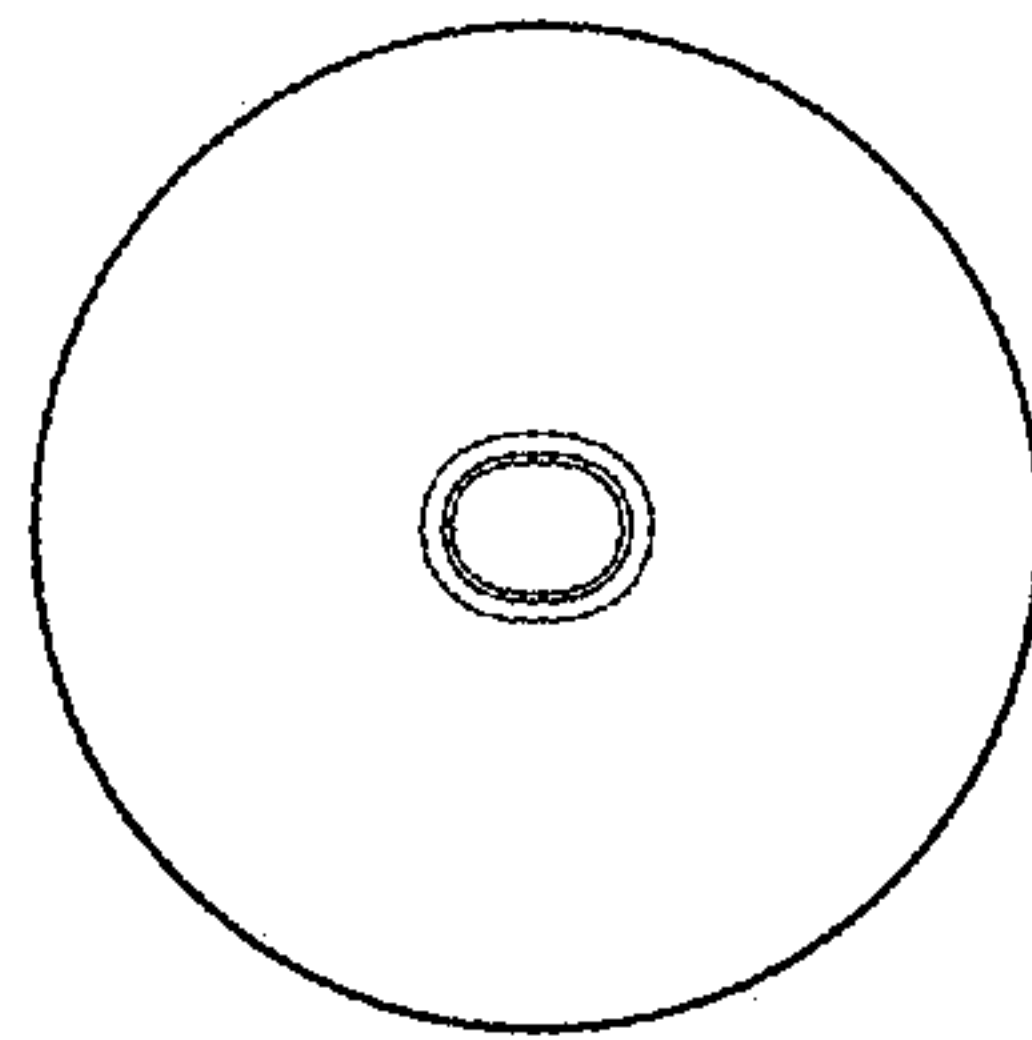

Figure 6

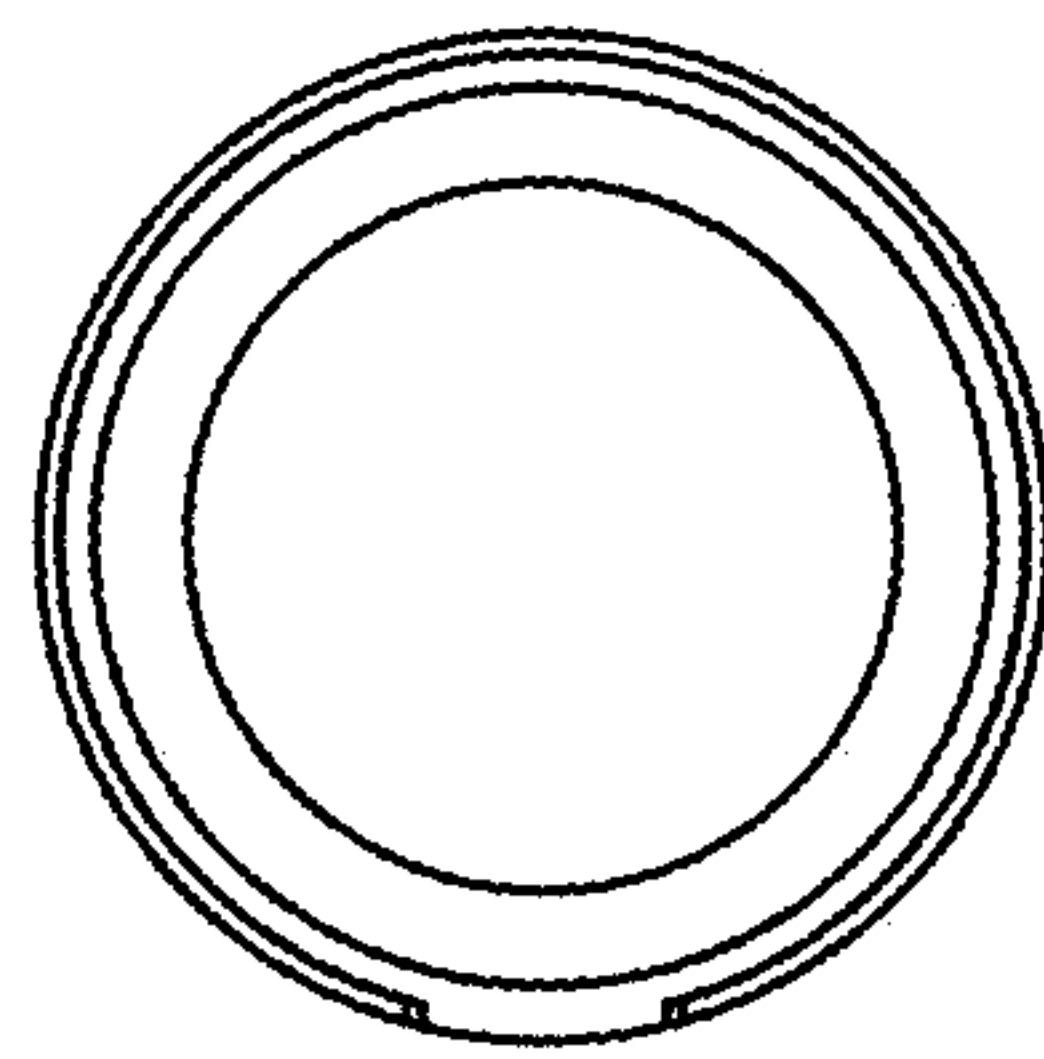

Figure 7

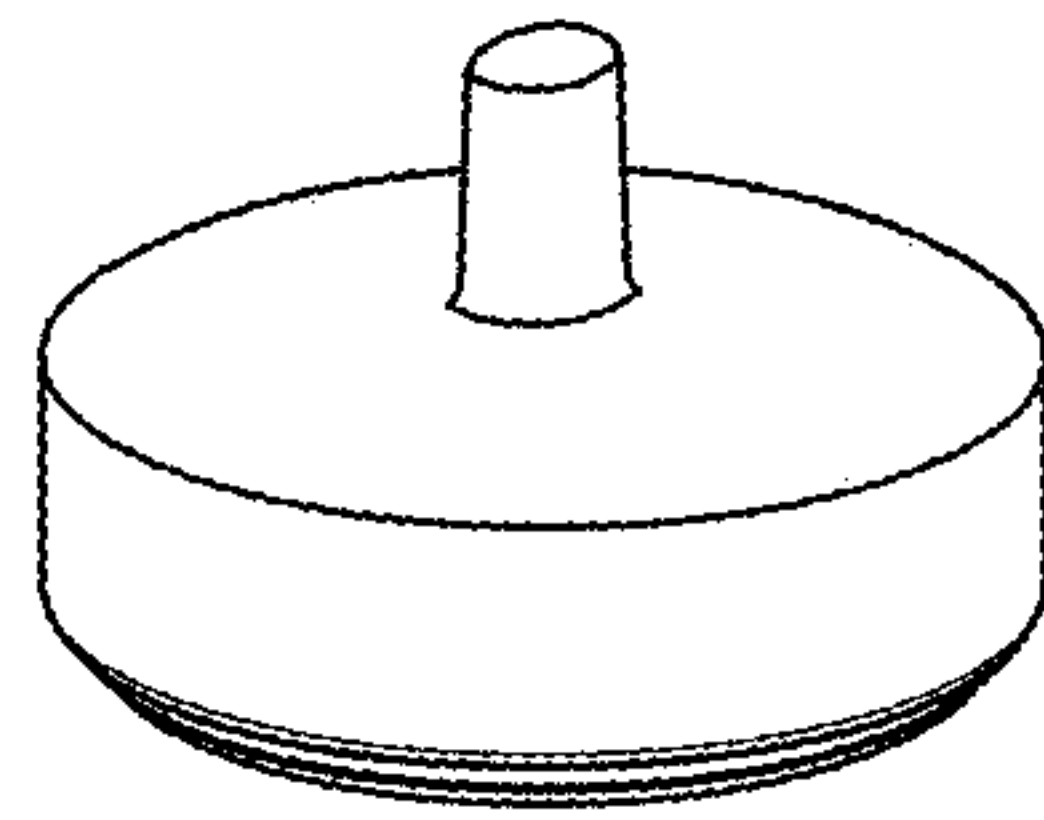

Figure 8

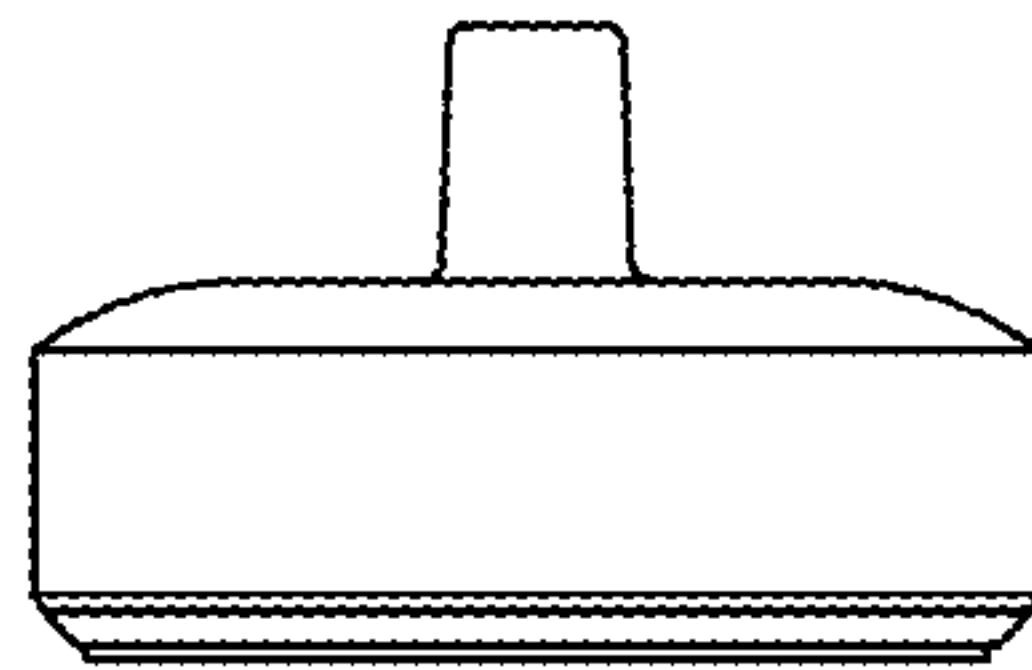

Figure 9

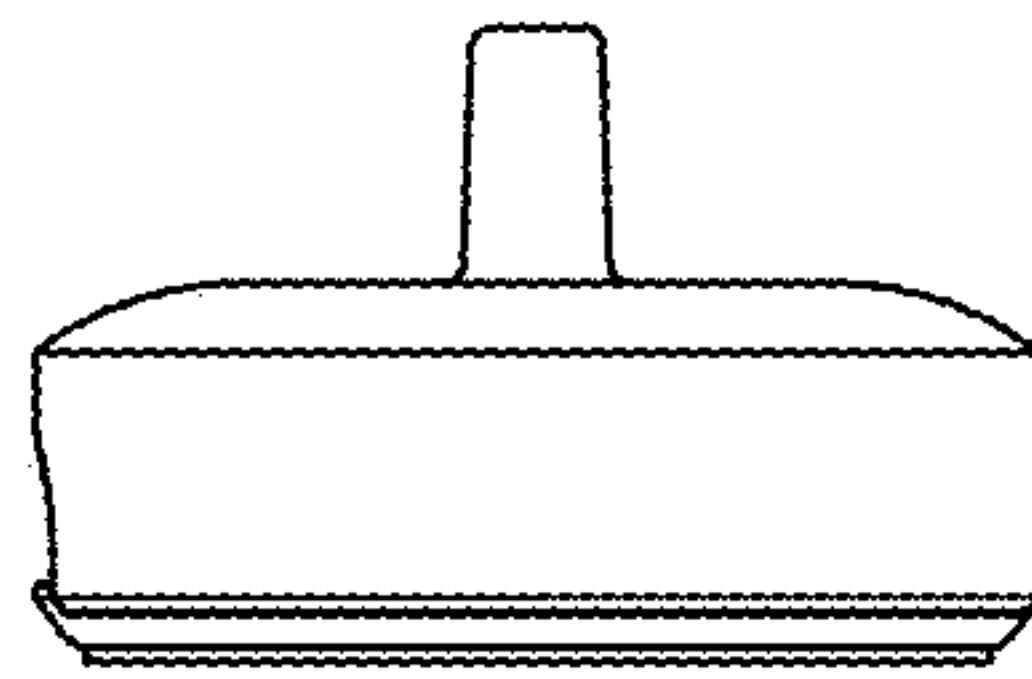

Figure 10

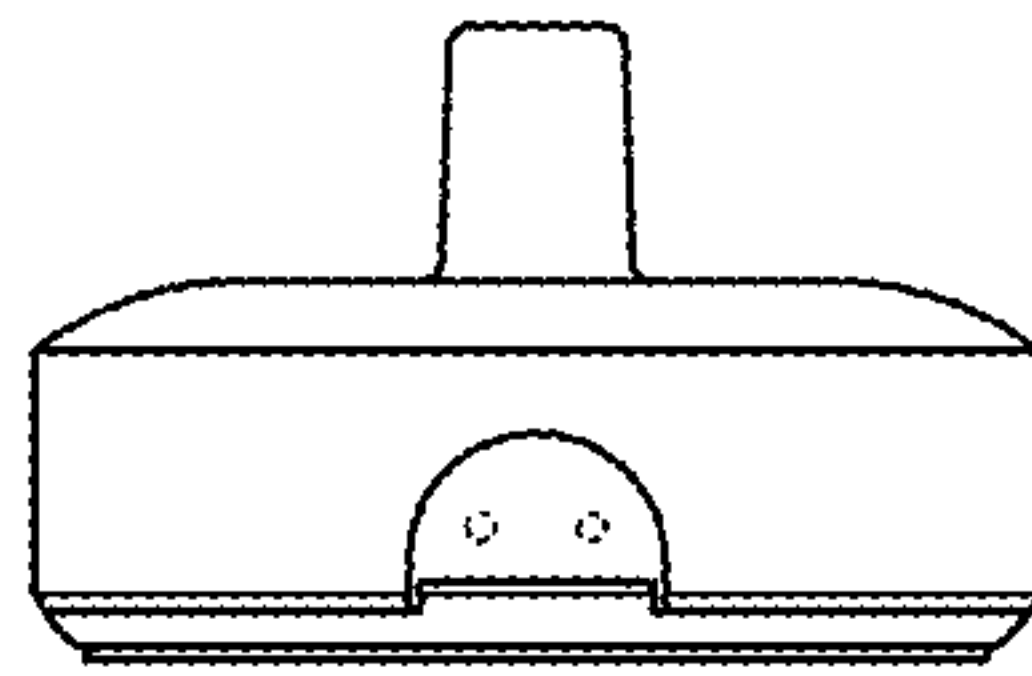

Figure 11

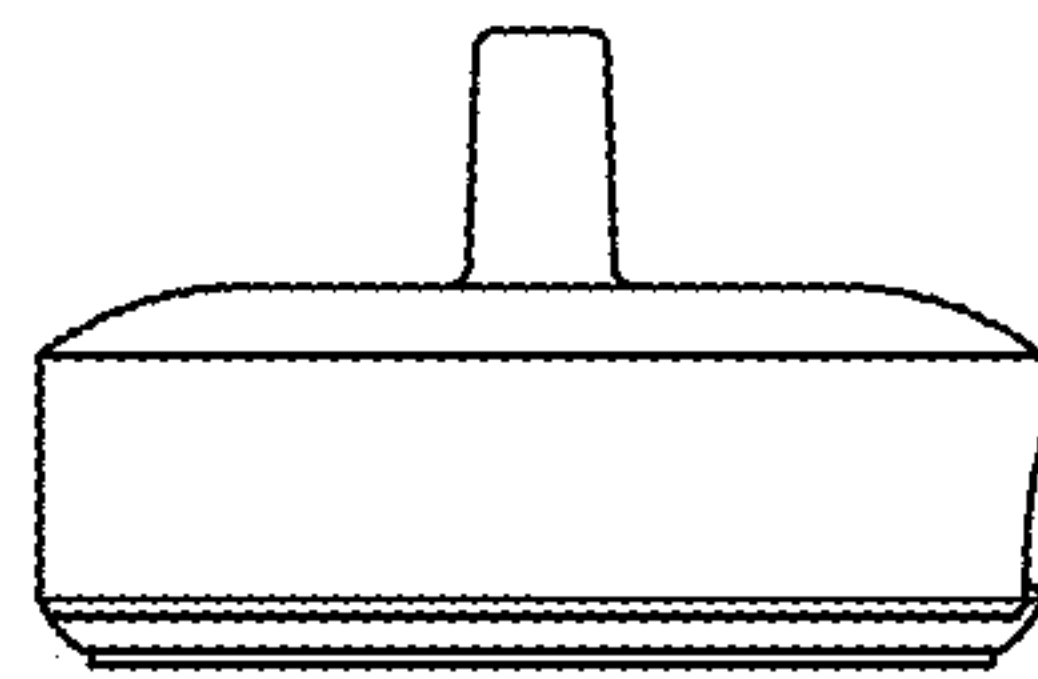

Figure 12

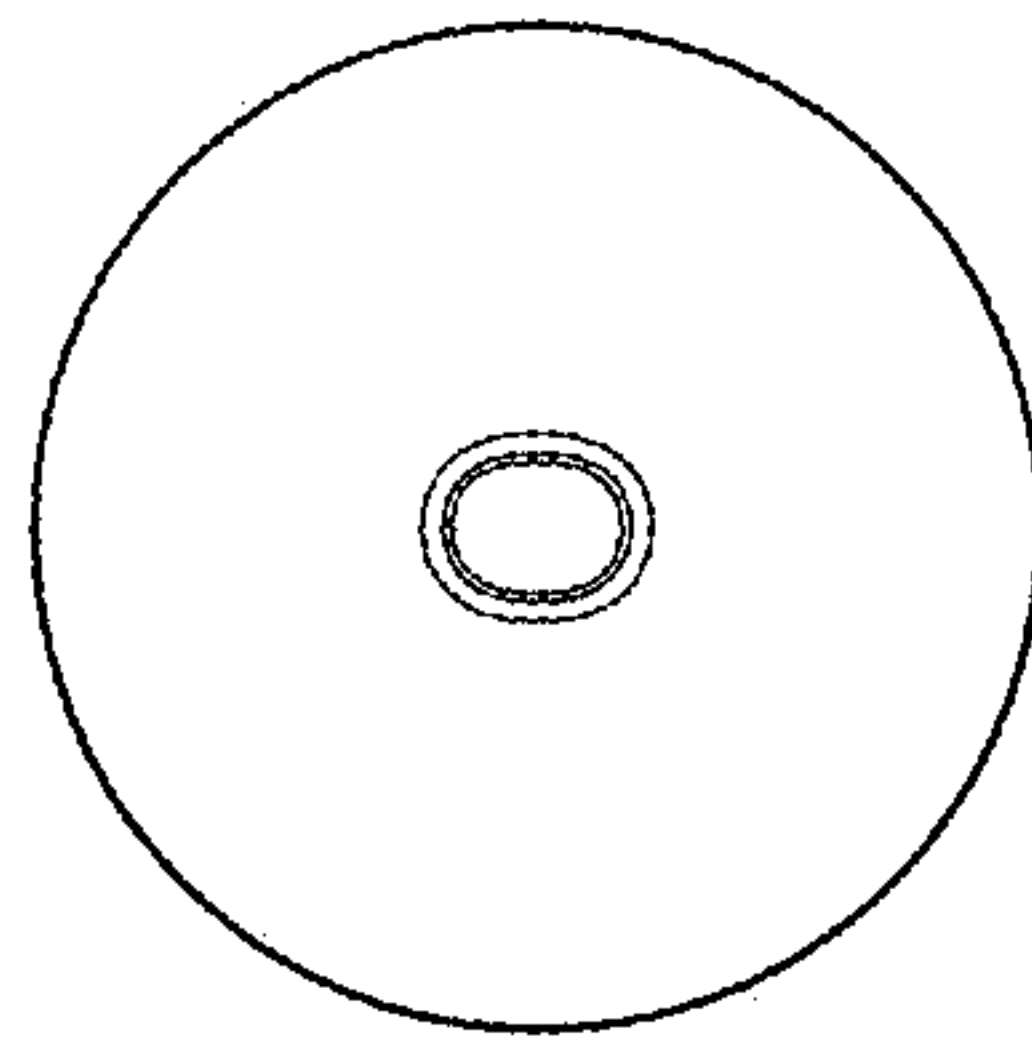

Figure 13

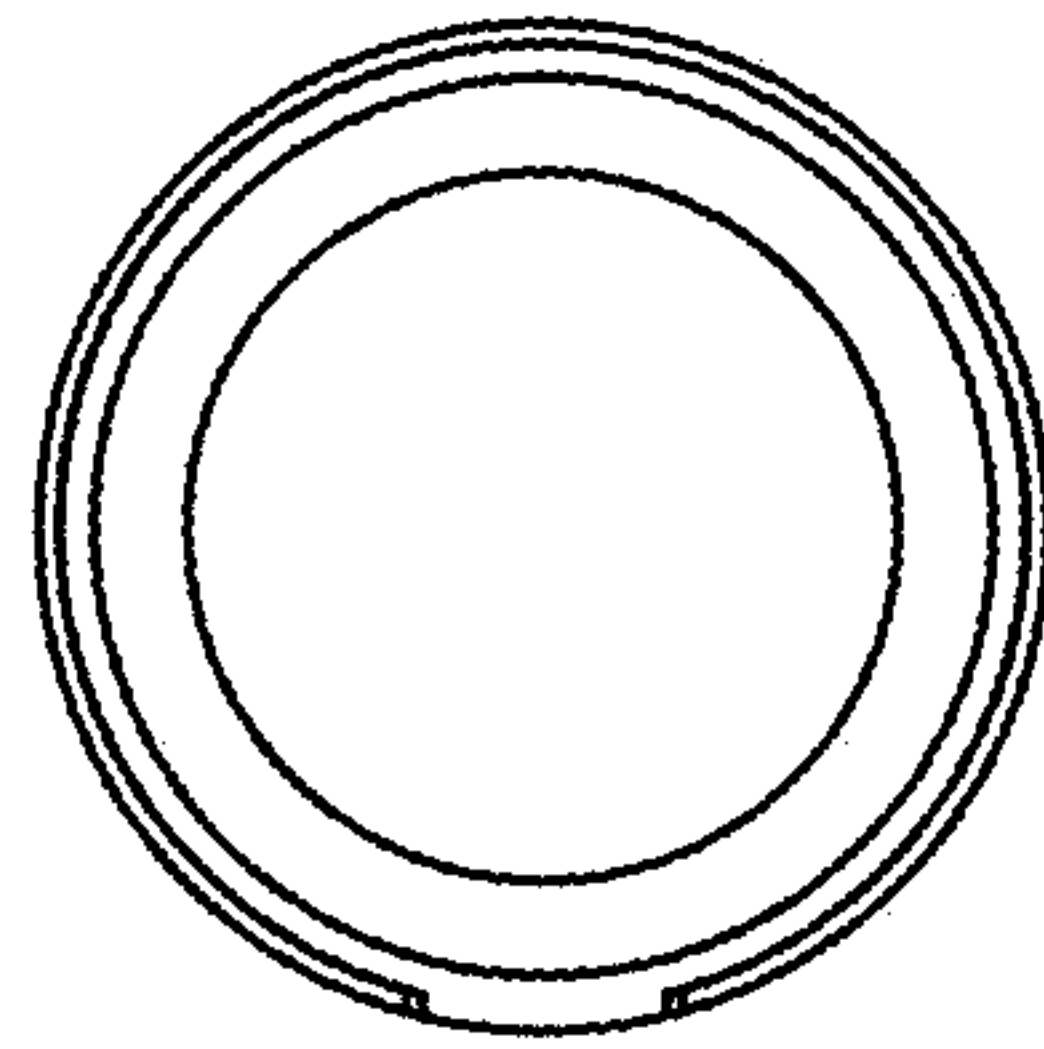

Figure 14