



US00D886011S

(12) **United States Design Patent** (10) **Patent No.:** **US D886,011 S**  
**Metros et al.** (45) **Date of Patent:** **\*\* Jun. 2, 2020**

(54) **VEHICLE REAR SPOILER**

(71) Applicant: **Ford Global Technologies, LLC**,  
Dearborn, MI (US)

(72) Inventors: **Craig S. Metros**, Bloomfield, MI (US);  
**Darrell Behmer**, Novi, MI (US);  
**Melvin Betancourt**, Shelby Township,  
MI (US); **Christopher Stevens**, Detroit,  
MI (US); **Stavros Melabiotis**, Livonia,  
MI (US); **Daniel Kangas**, Livonia, MI  
(US)

(73) Assignee: **Ford Global Technologies, LLC**,  
Dearborn, MI (US)

(\*\*) Term: **15 Years**

(21) Appl. No.: **29/673,822**

(22) Filed: **Dec. 18, 2018**

(51) **LOC (12) Cl.** ..... **12-16**

(52) **U.S. Cl.**  
USPC ..... **D12/181**

(58) **Field of Classification Search**  
USPC ..... D12/190–192, 181, 415, 196, 400, 173,  
D12/126, 169, 203, 414, 171, 110, 114;  
180/90; 280/750, 751, 752, 740, 741,  
280/848; 296/191; 293/113, 102, 117  
CPC . B60R 2013/0293; B60R 21/20; B60R 21/06;  
B60R 13/02; B60R 13/04; B62D 35/007;  
B62D 37/02

See application file for complete search history.

(56) **References Cited**

U.S. PATENT DOCUMENTS

D726,608 S	4/2015	Curic et al.	
D775,026 S *	12/2016	Platto .....	D12/181
D827,524 S	9/2018	Behmer et al.	
D848,321 S *	5/2019	Lu .....	D12/169
D865,595 S *	11/2019	Grand .....	D12/181
D875,004 S *	2/2020	Chiang .....	D12/181
D876,300 S *	2/2020	Chiang .....	D12/181

OTHER PUBLICATIONS

Reese Counts, 2020 Ford Shelby GT500 revealed in Instagram post,  
<https://www.autoblog.com> Oct. 18, 2018.

\* cited by examiner

*Primary Examiner* — Abraham Bahta  
(74) *Attorney, Agent, or Firm* — Vichit Chea

(57) **CLAIM**  
The ornamental design for a vehicle rear spoiler, as shown  
and described.

**DESCRIPTION**

FIG. 1 is a front elevational view of a vehicle rear spoiler,  
showing our new design;  
FIG. 2 is a rear elevational view thereof;  
FIG. 3 is a left side elevational view thereof;  
FIG. 4 is a right side elevational view thereof;  
FIG. 5 is a top plan view thereof;  
FIG. 6 is a bottom plan view thereof;  
FIG. 7 is a top, front and left side perspective view thereof;  
and,  
FIG. 8 is a top, rear and right side perspective view thereof.

**1 Claim, 8 Drawing Sheets**

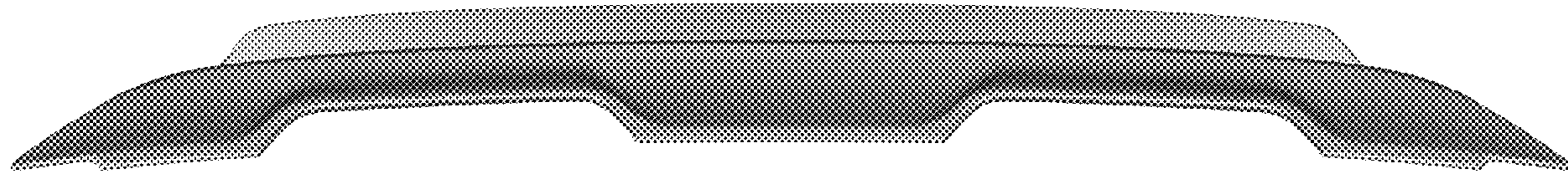

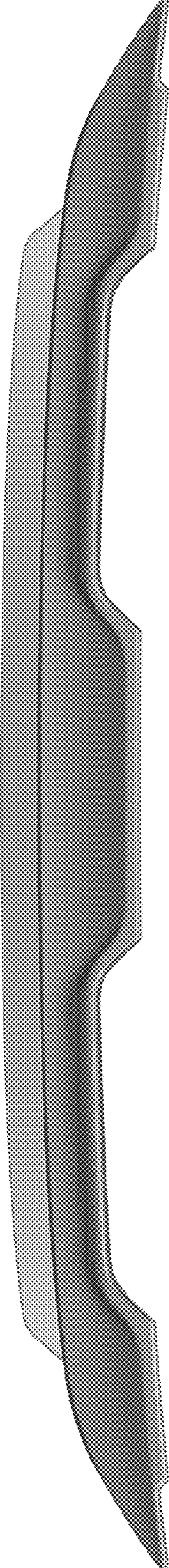

*Fig. 1*

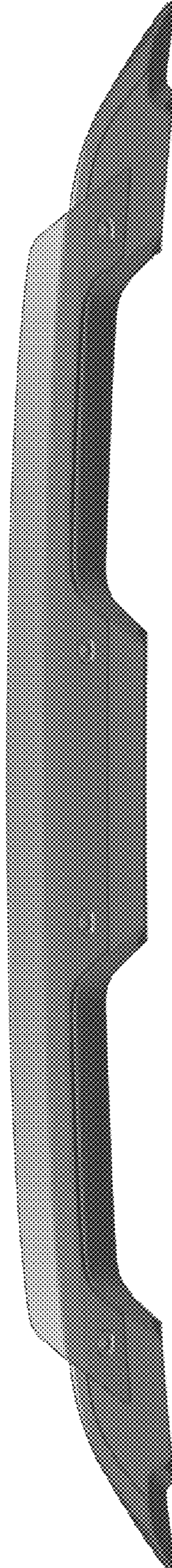
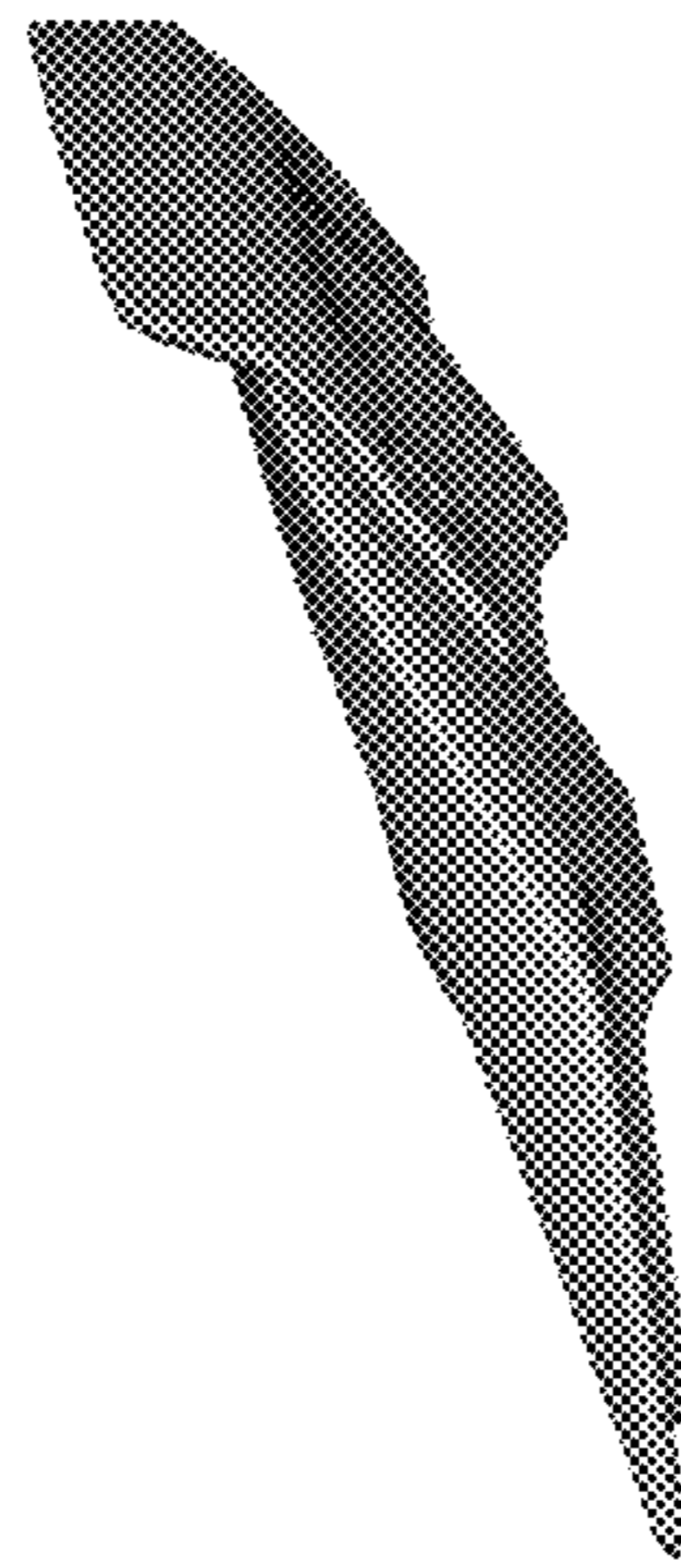
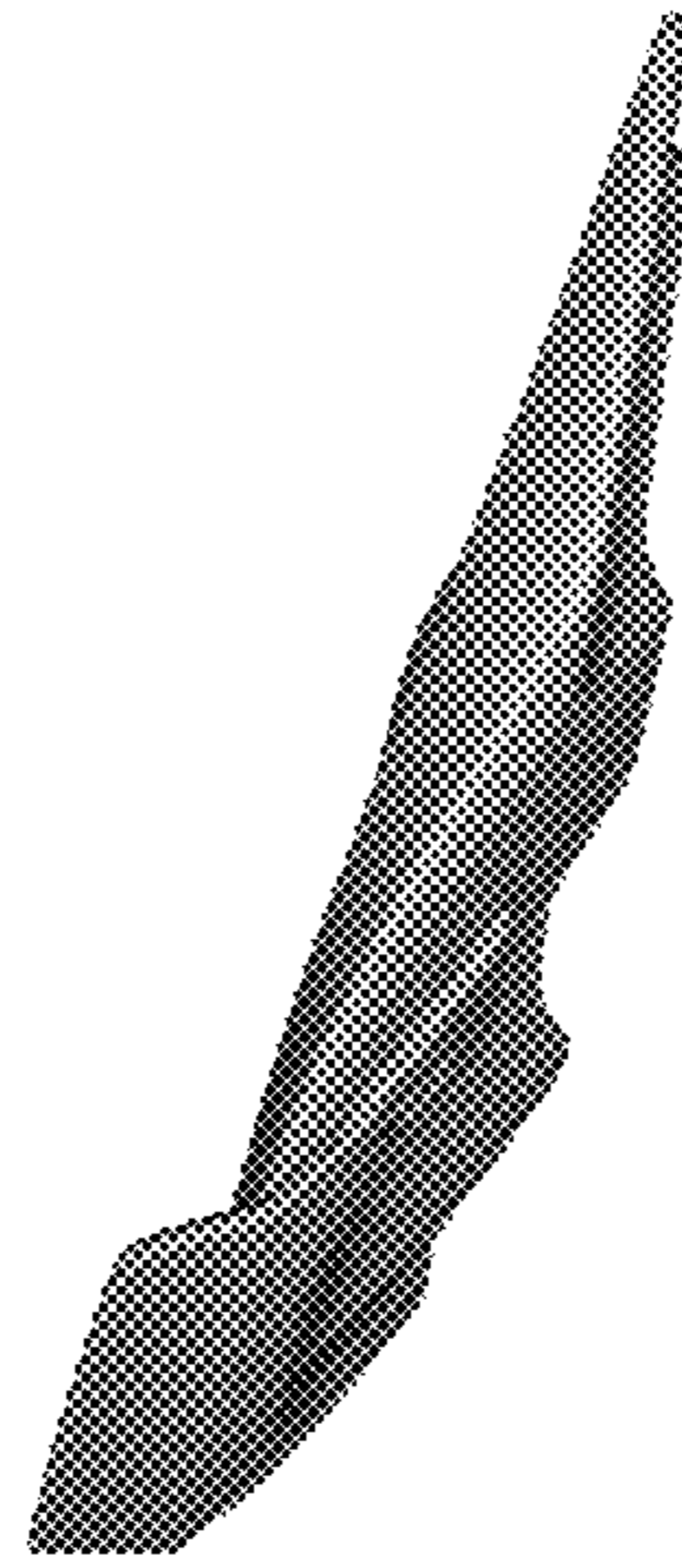

Fig. 2



*Fig. 3*



*Fig. 4*

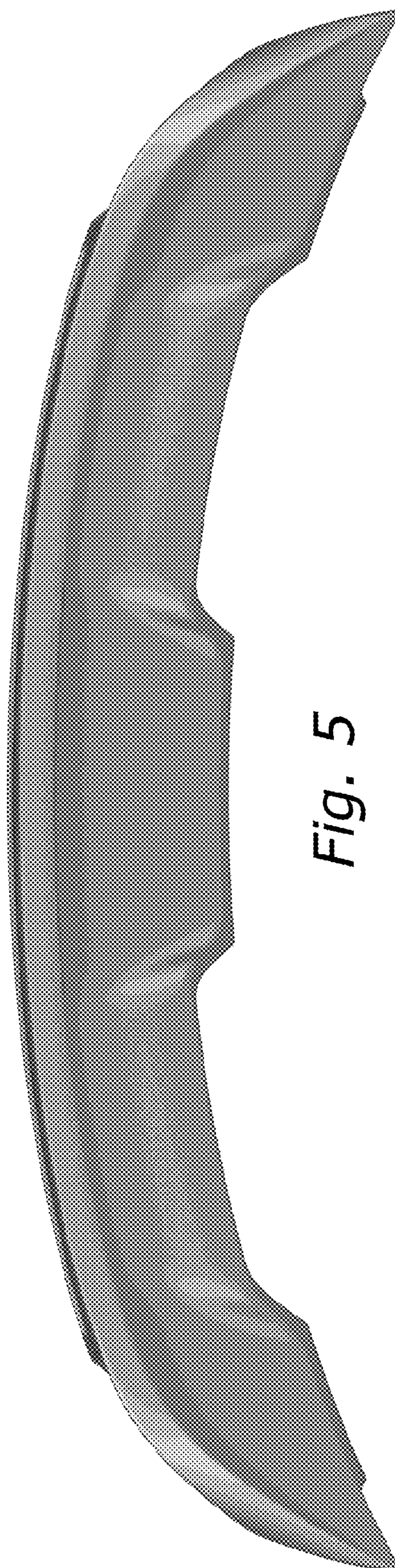
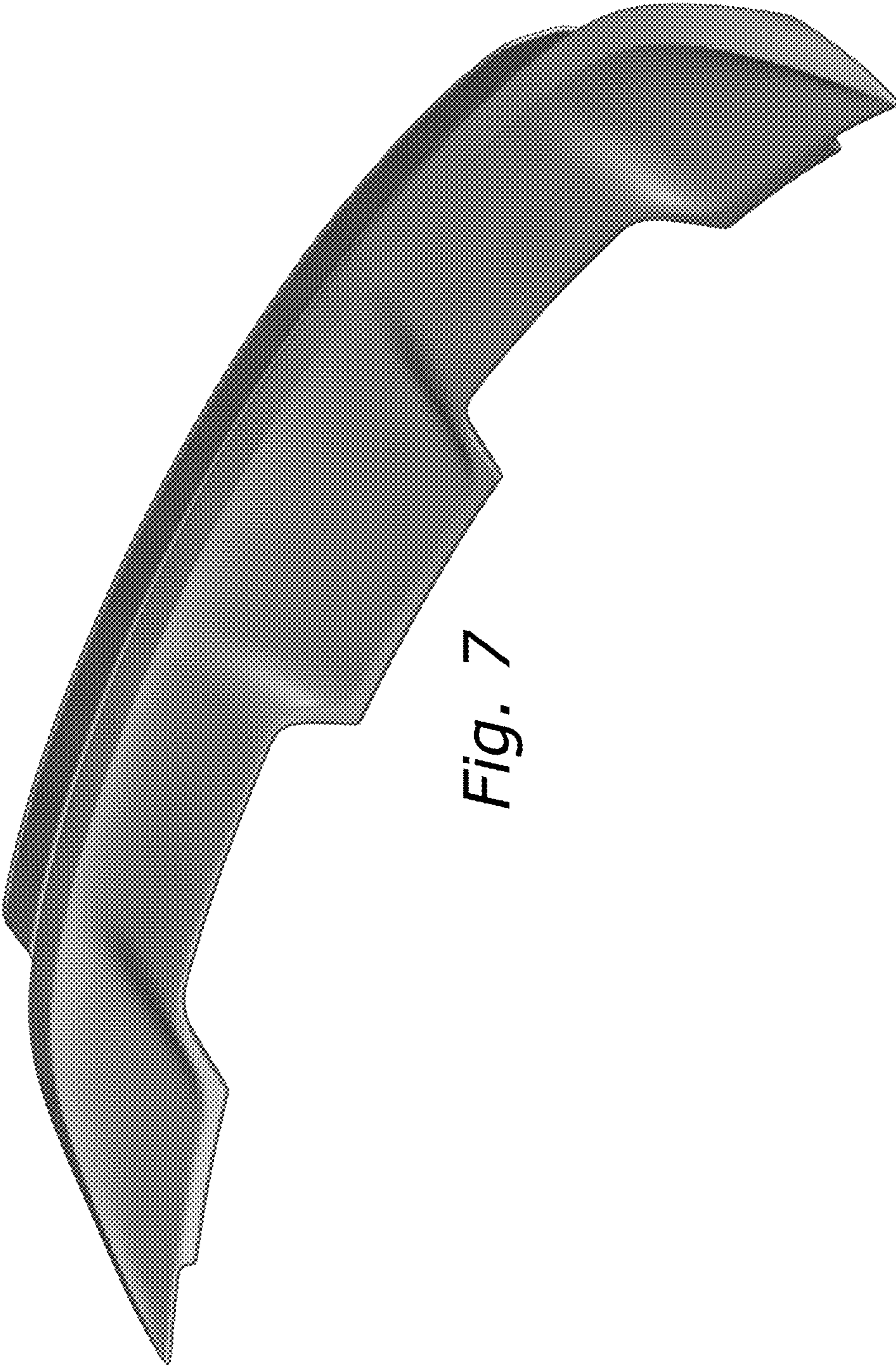

Fig. 5



*Fig. 6*



**Fig. 7**



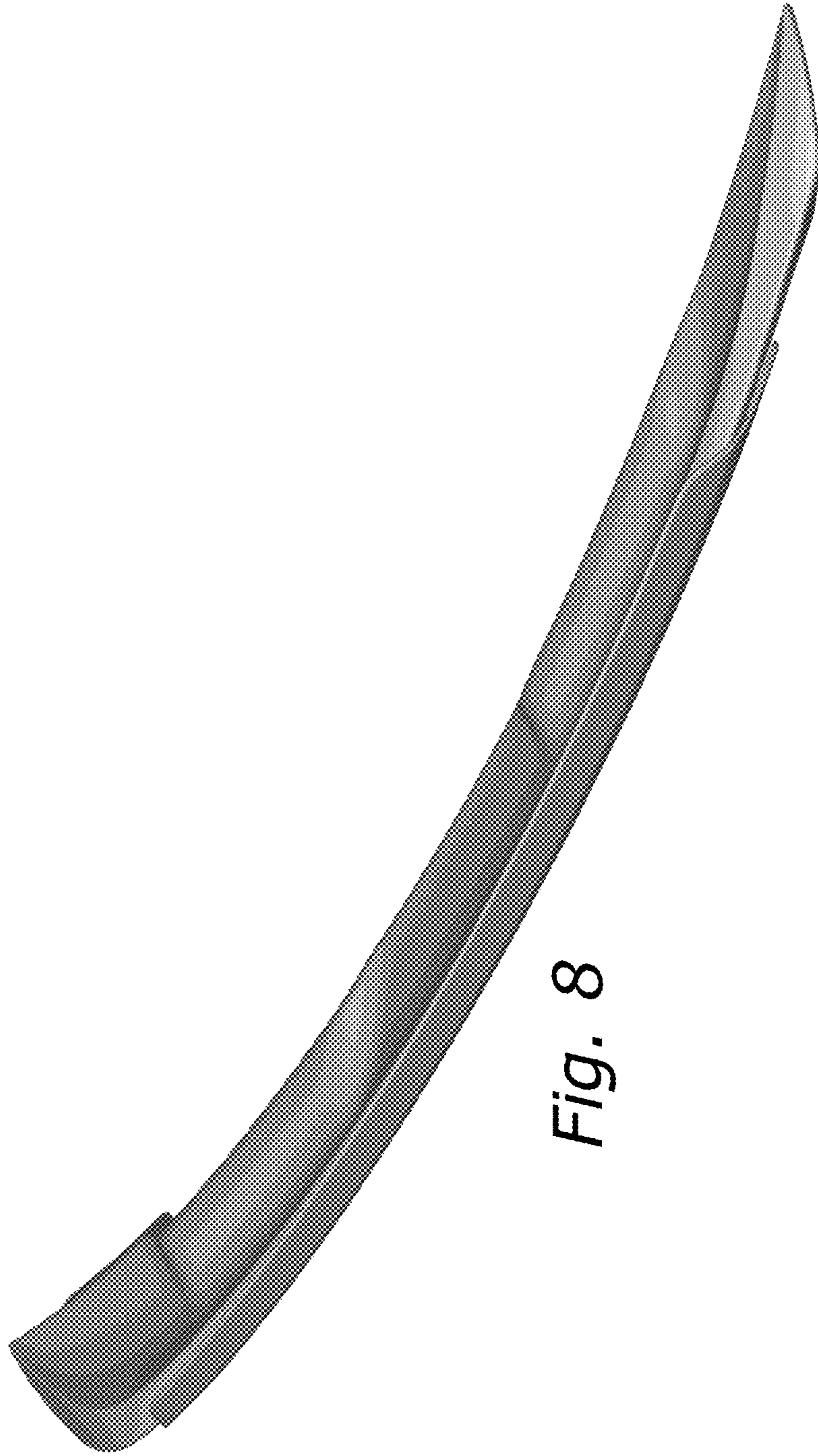

Fig. 8