



US00D885971S

(12) **United States Design Patent**  
**Swims et al.**

(10) **Patent No.:** **US D885,971 S**  
(45) **Date of Patent:** **\*\* Jun. 2, 2020**

(54) **CLASP**  
(71) Applicant: **Jack & Izzy, LLC**, Atlanta, GA (US)  
(72) Inventors: **Teresa Kane Swims**, Atlanta, GA (US);  
**Meredith Van Houten**, Atlanta, GA (US)

2,053,651 A 9/1936 Battin  
2,435,174 A 1/1948 Bell  
2,442,698 A 6/1948 Lang  
2,447,422 A 8/1948 Nelson  
2,641,039 A 6/1953 Bissell  
(Continued)

FOREIGN PATENT DOCUMENTS

(73) Assignee: **Jack & Izzy, LLC**, Atlanta, GA (US)  
(\*\*) Term: **15 Years**

JP 3040251 8/1997  
KR 101457458 11/2014

OTHER PUBLICATIONS

(21) Appl. No.: **29/705,957**

ISA/US, Int. Search Report and Written Opinion issued on PCT application No. US2017/050220, dated Nov. 16, 2017, 7 pgs.

(22) Filed: **Sep. 17, 2019**

(Continued)

(51) **LOC (12) Cl.** ..... **02-07**

(52) **U.S. Cl.**  
USPC ..... **D11/200**; D8/395

(58) **Field of Classification Search**  
USPC ..... D3/215, 239, 263, 265, 266; D8/383,  
D8/394, 395; D11/1, 2, 3, 12, 16, 86, 87,  
D11/93, 200, 201, 206-210, 212-218,  
D11/229-237

*Primary Examiner* — Kevin K Rudzinski  
*Assistant Examiner* — Richard Kearney  
(74) *Attorney, Agent, or Firm* — Greenberg Traurig, LLP

CPC . A45F 5/00; A45F 5/004; A45F 5/006; A62B  
35/00; A44B 11/06; A44B 11/22; G02C  
11/00; G02C 11/02; G02C 3/006

See application file for complete search history.

(57) **CLAIM**

The ornamental design for a clasp, as shown and described.

**DESCRIPTION**

(56) **References Cited**

U.S. PATENT DOCUMENTS

180,430 A 8/1876 Lambert  
703,485 A 7/1902 Shedlock  
1,387,230 A 8/1921 Brannigan  
1,503,288 A 7/1924 Poole  
1,507,706 A \* 9/1924 Miller ..... B63B 23/58  
294/82.32  
1,619,783 A 3/1927 Chase  
1,767,720 A 6/1930 Treloar  
1,780,880 A 11/1930 Johnson  
1,849,020 A 3/1932 Allison  
2,011,127 A \* 8/1935 Tait ..... A22C 15/005  
452/193  
2,031,484 A 2/1936 Inerrante

FIG. 1 is perspective view of a clasp showing our new design;  
FIG. 2 is a front view thereof, the back view being a mirror image thereof;  
FIG. 3 is a left side view thereof;  
FIG. 4 is a right side view thereof;  
FIG. 5 is top plan view thereof; and,  
FIG. 6 is a bottom plan view thereof.  
The broken lines shown in the drawings illustrate portions of the clasp and form no part of the claimed design. The dot-dash-dot lines shown in the drawings illustrate the bounds of the claim and form no part of the claimed design.

**1 Claim, 4 Drawing Sheets**

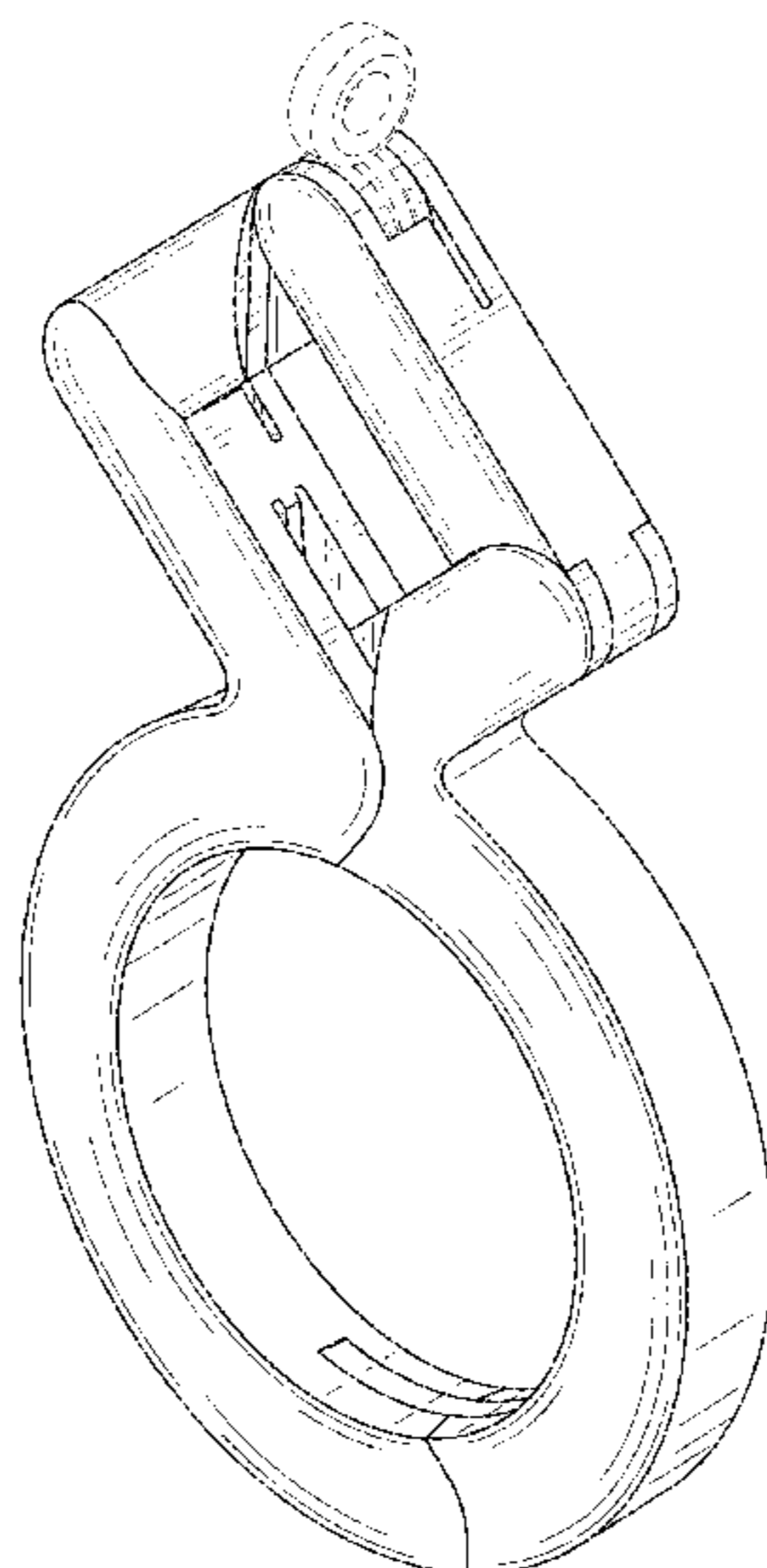

(56)

References Cited

U.S. PATENT DOCUMENTS

3,545,049 A 12/1970 Brueggeman  
 3,697,117 A \* 10/1972 Larson ..... B66C 1/422  
 294/106  
 3,956,804 A 5/1976 Gatof et al.  
 4,109,952 A \* 8/1978 Monzain ..... B65G 7/12  
 294/118  
 4,245,377 A 1/1981 Soltes  
 4,324,025 A 4/1982 Apri  
 D269,770 S 7/1983 Pittenger et al.  
 4,441,746 A 4/1984 Corboy, Jr.  
 4,452,481 A \* 6/1984 Williams ..... B66C 1/64  
 294/118  
 4,665,594 A 5/1987 Wagner  
 4,678,220 A \* 7/1987 Gabriel ..... B66C 3/02  
 294/110.1  
 D295,268 S 4/1988 Riethmann  
 4,778,211 A \* 10/1988 Gabriel ..... E02F 3/02  
 294/115  
 D390,496 S 2/1998 Olsen  
 5,805,262 A 9/1998 Deveney  
 5,860,191 A 1/1999 Sieger  
 5,893,198 A 4/1999 Decotis  
 D454,087 S 3/2002 Braner  
 6,412,152 B1 7/2002 Ayliffe et al.  
 6,533,414 B2 3/2003 Newler  
 6,598,268 B1 7/2003 Zelman  
 6,662,598 B2 12/2003 Meehan  
 7,322,214 B2 1/2008 Ignatowski  
 7,448,155 B2 11/2008 Dolas  
 7,721,392 B2 5/2010 Avery  
 7,850,302 B1 12/2010 Riazzi  
 D649,348 S \* 11/2011 Murphy, Jr. .... D3/266  
 D723,970 S 3/2015 Tomaselli  
 D724,429 S \* 3/2015 Weber, Sr. .... D9/434  
 9,144,271 B2 9/2015 Tribelhorn

9,341,203 B1 5/2016 Disharoon  
 D787,364 S 5/2017 Grange  
 D801,211 S 10/2017 Tomaselli  
 D824,283 S \* 7/2018 Swims ..... D11/200  
 2005/0241115 A1 11/2005 Zoullas  
 2006/0248688 A1 11/2006 Vermillion  
 2007/0064196 A1 \* 3/2007 Avery ..... G02C 11/00  
 351/112  
 2010/0263170 A1 10/2010 Dollar, Sr.  
 2011/0277276 A1 11/2011 Pucci  
 2012/0184976 A1 7/2012 Nakamura  
 2014/0320798 A1 \* 10/2014 Tribelhorn ..... G02C 3/04  
 351/112  
 2016/0025996 A1 1/2016 Bacon  
 2016/0058137 A1 3/2016 Prestwidge  
 2016/0215812 A1 7/2016 Durfee  
 2017/0224068 A1 8/2017 Williams  
 2018/0078022 A1 \* 3/2018 Swims ..... A45F 5/00

OTHER PUBLICATIONS

50/100Pcs Silver/Gold/Bronze Lobster Claw Clasps Hook, Ebay.com, [online], [site visited Dec. 4, 2017]. <URL: <https://www.ebay.com/i/281690755627?chn=ps>> (Year: 2017), 4 pgs.  
 Clasps, FireMountainGems.com., [online], [site visited Dec. 4, 2017]. <URL: <http://www.firemountaingems.com/shop/clasps>> (Year: 2017), 2 pgs.  
 Silver Plated Celtic Knot Toggle Clasp, SpoiltRottenBeads.co.uk, [online], [site visited Dec. 4, 2017]. <URL: <https://www.spoiltrottenbeads.co.uk/product-category/components-clasps-toggles-silver-clasps-toggles/>> (Year: 2017), 1 pg.  
 11x5mm Sterling Silver Lobster, GemPacked.com, [online], [site visited Dec. 4, 2017]. <URL: <https://www.gempacked.com/findings-jewelry-components-and-parts-3/clasps-sterling-silver-gold-filled-and-more-16/lobster-clasps-and-trigger-clasps-160/>> (Year: 2017), 2 pgs.

\* cited by examiner

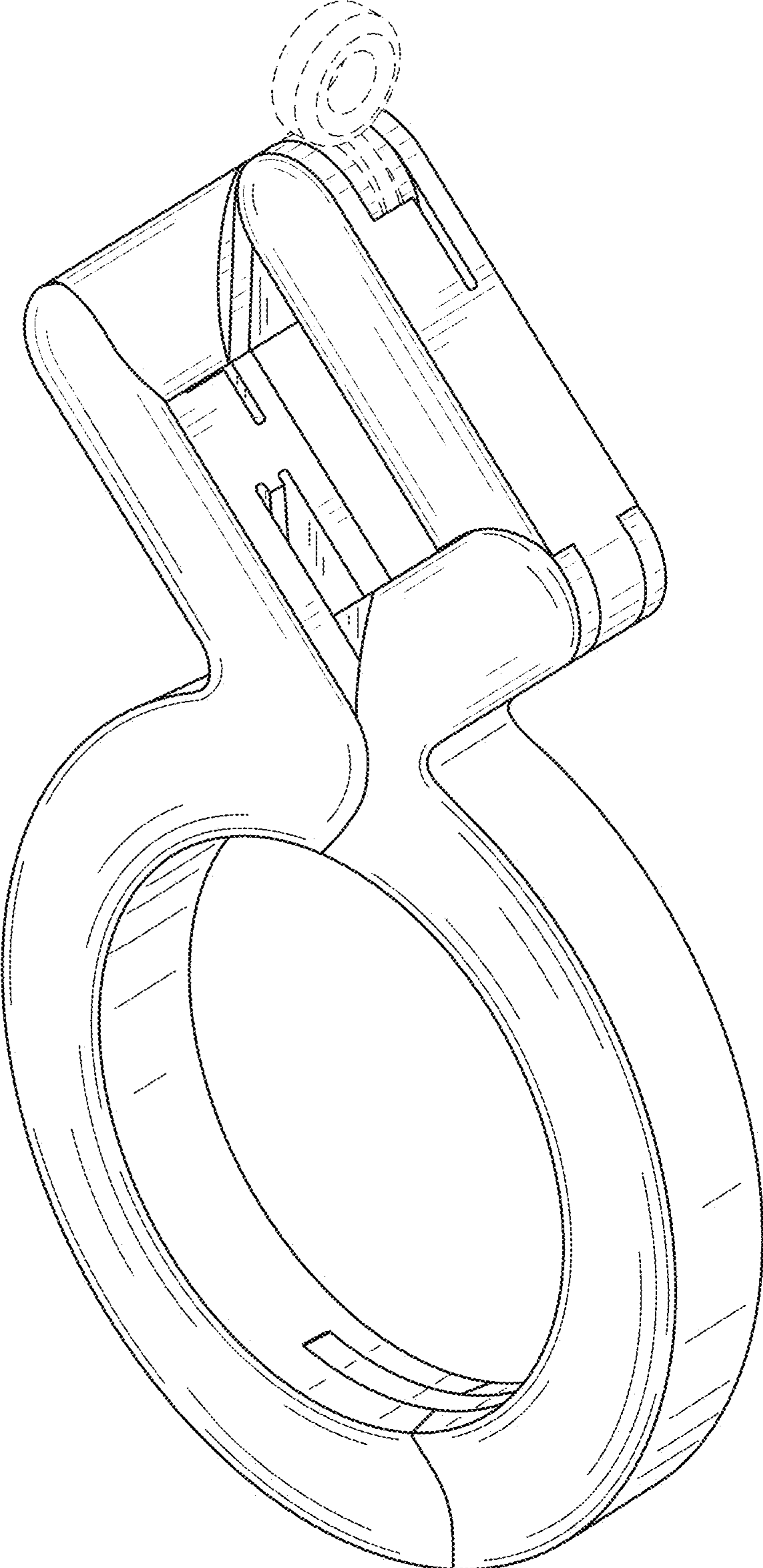

FIG. 1

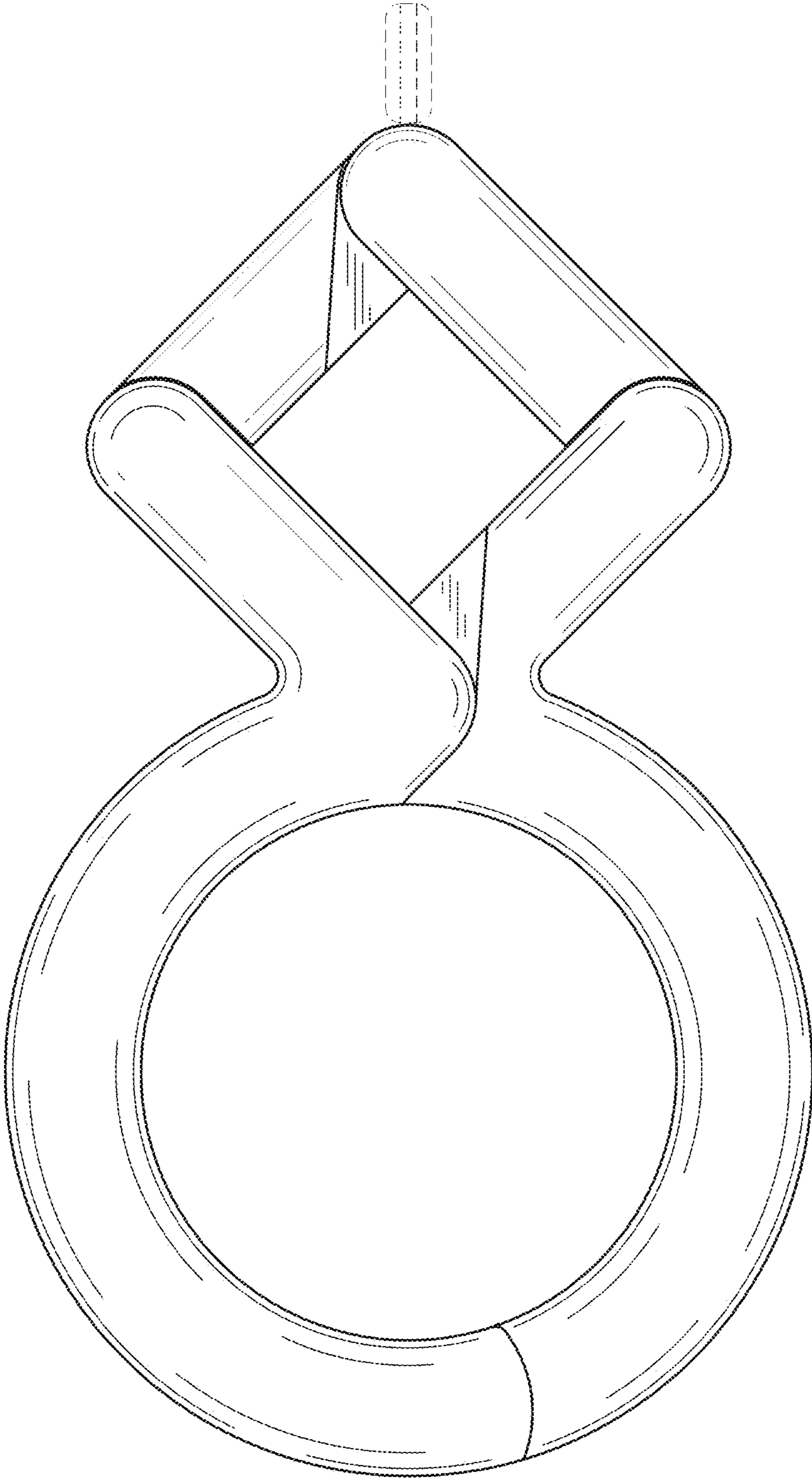

FIG. 2

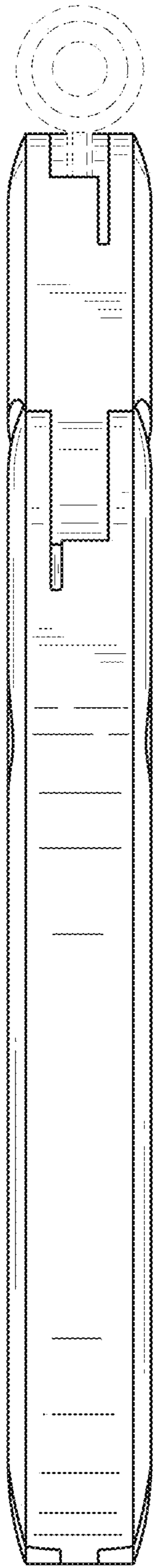

FIG. 3

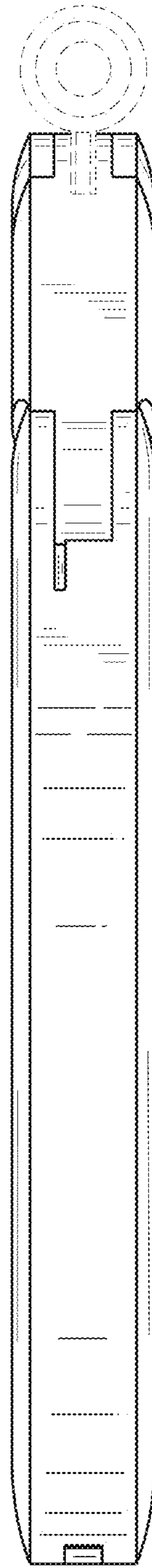

FIG. 4

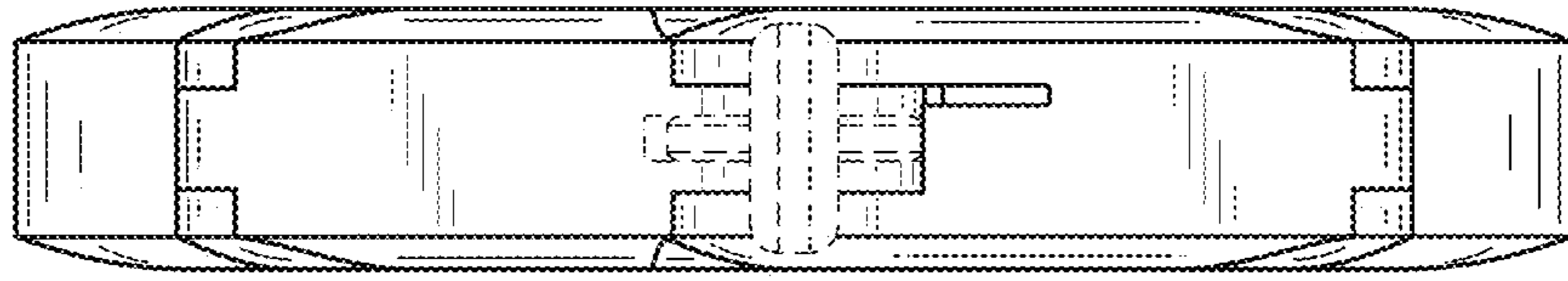

FIG. 5

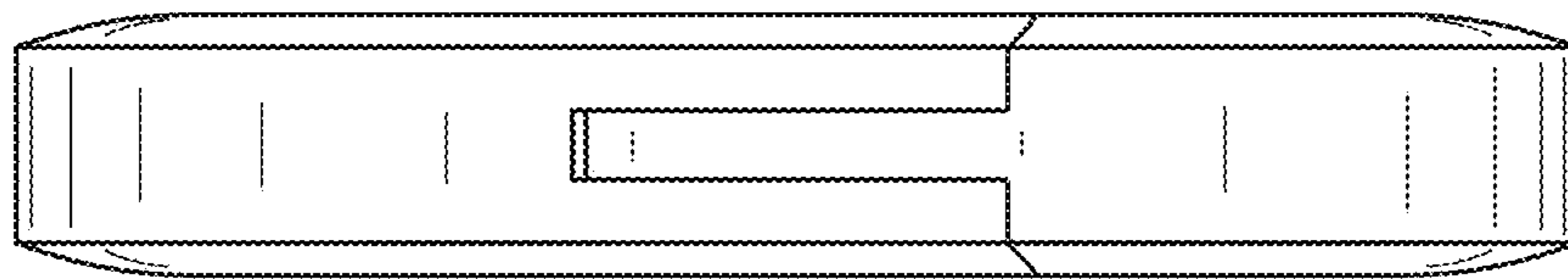

FIG. 6

UNITED STATES PATENT AND TRADEMARK OFFICE  
**CERTIFICATE OF CORRECTION**

PATENT NO. : D885,971 S  
APPLICATION NO. : 29/705957  
DATED : June 2, 2020  
INVENTOR(S) : Swims et al.

Page 1 of 5

It is certified that error appears in the above-identified patent and that said Letters Patent is hereby corrected as shown below:

Please delete FIGS. 1-6 and insert new FIGS. 1-6 as shown on attached pages.

Signed and Sealed this  
Eighth Day of December, 2020

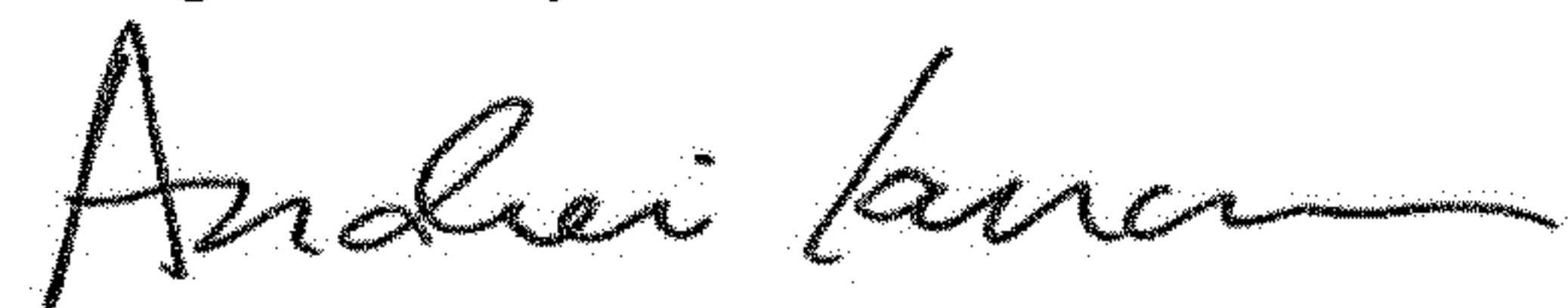

Andrei Iancu  
*Director of the United States Patent and Trademark Office*

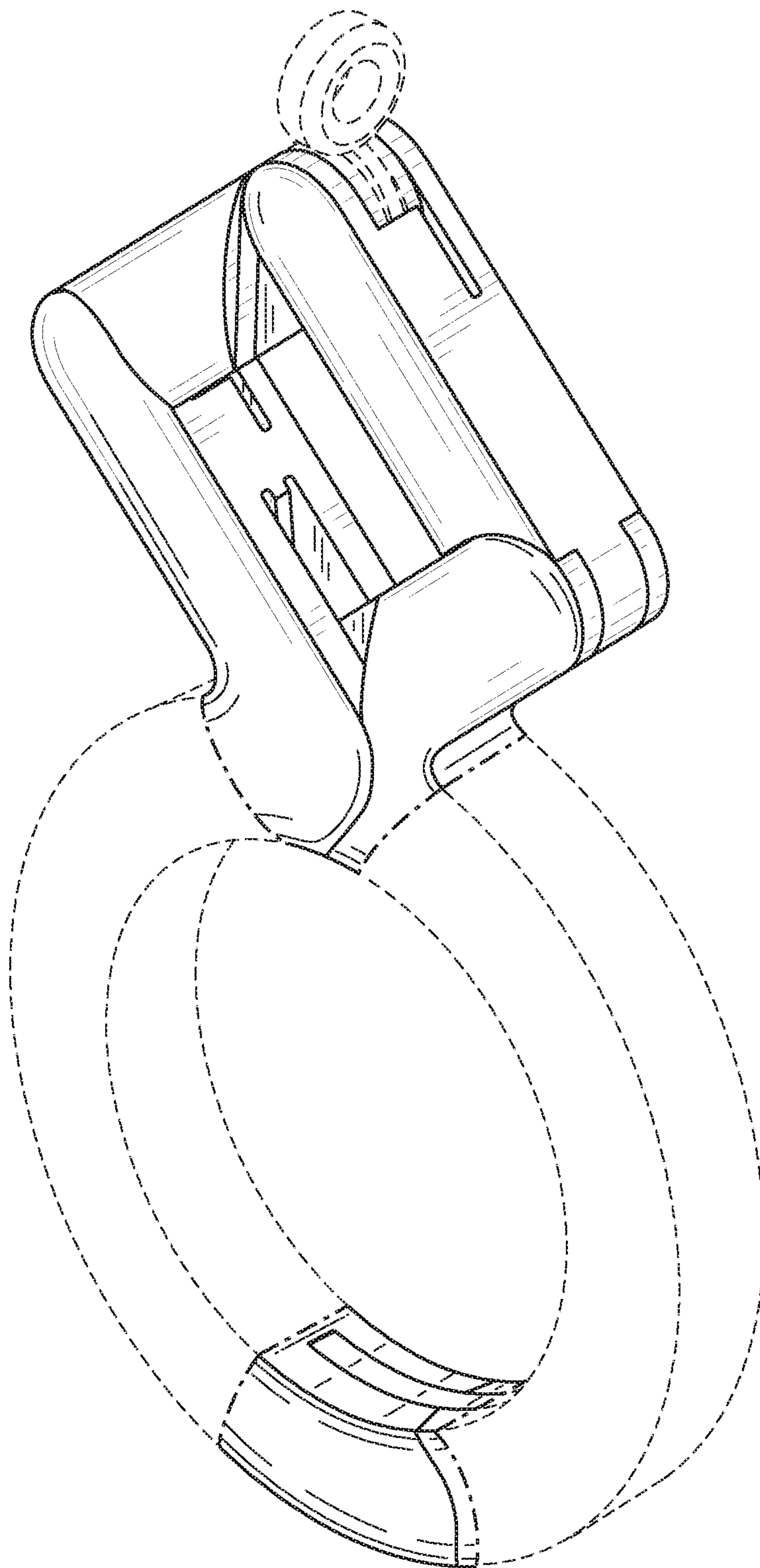

FIG. 1



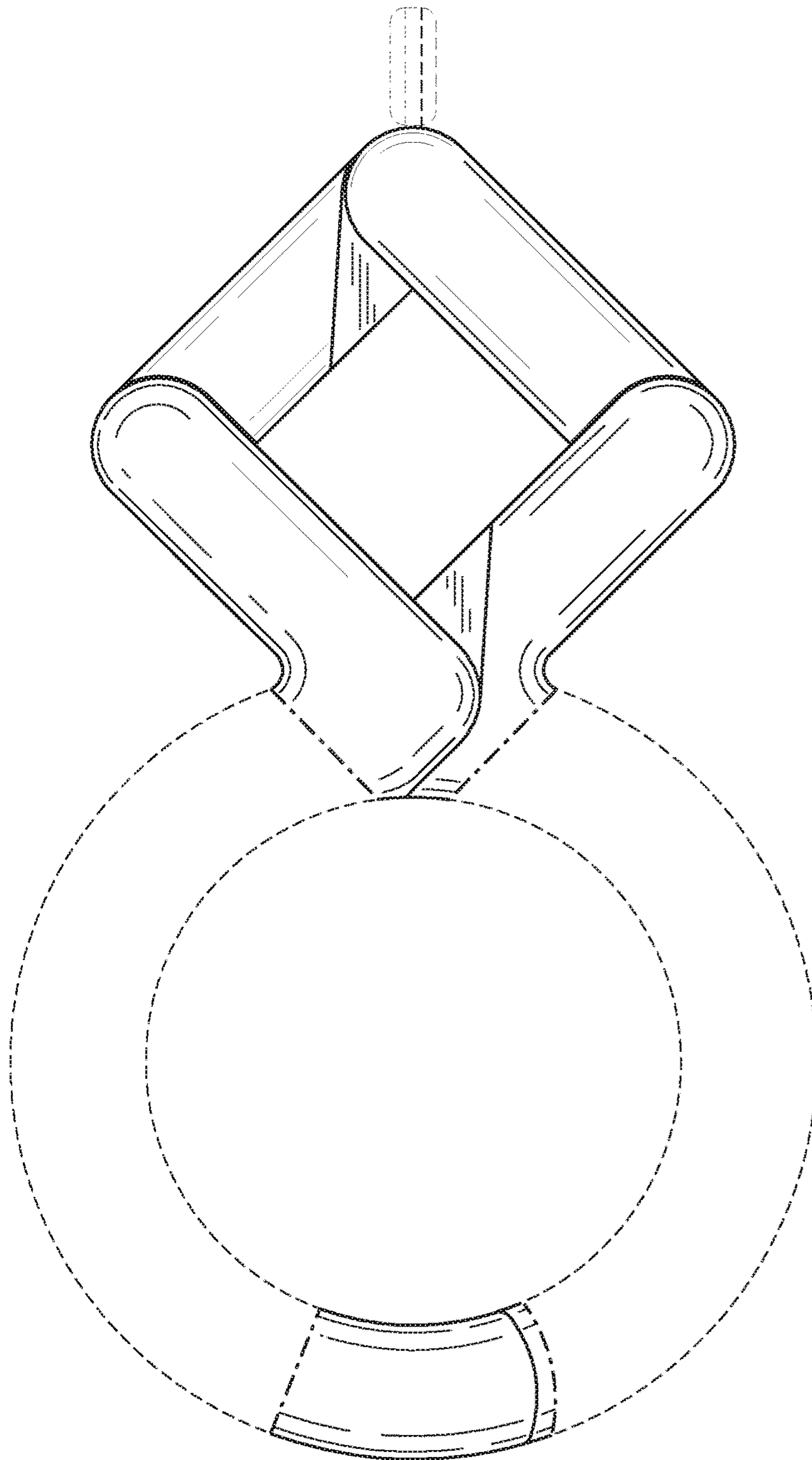

FIG. 2

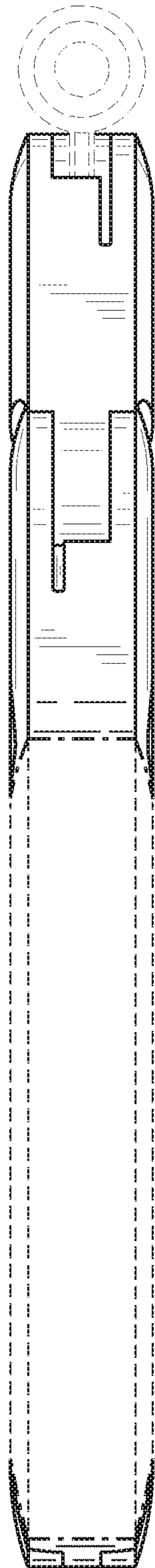

FIG. 3

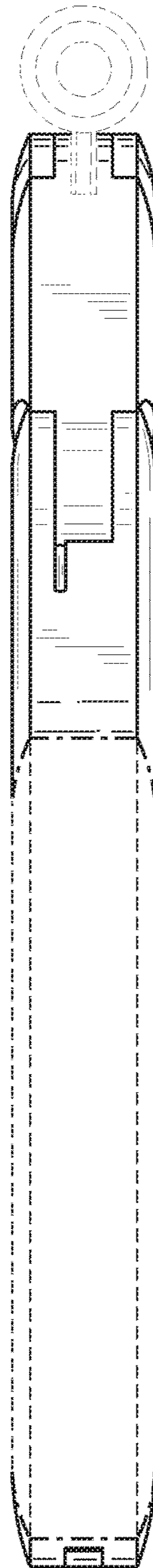

FIG. 4

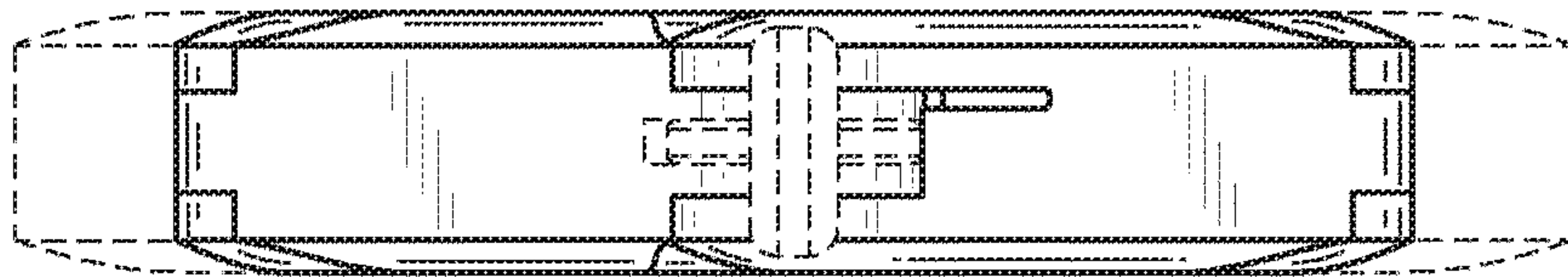

FIG. 5

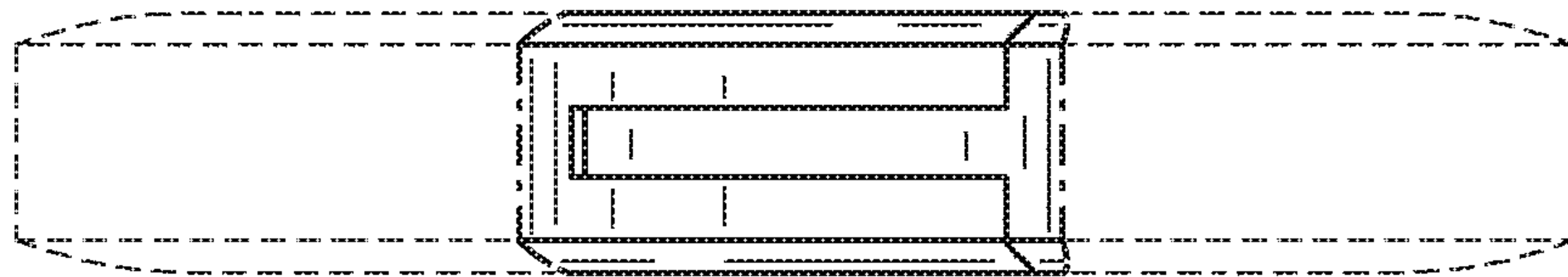

FIG. 6