



US00D885945S

(12) **United States Design Patent** (10) **Patent No.:** **US D885,945 S**
Cohen et al. (45) **Date of Patent:** **** Jun. 2, 2020**

(54) **WEARABLE COACHING DEVICE**

(71) Applicants: **Marc A Cohen**, McLean, VA (US);
Alain J. Cohen, McLean, VA (US)

(72) Inventors: **Marc A Cohen**, McLean, VA (US);
Alain J. Cohen, McLean, VA (US)

(73) Assignee: **Neuro Tennis, Inc.**, Arlington, VA (US)

(**) Term: **15 Years**

(21) Appl. No.: **29/672,661**

(22) Filed: **Dec. 7, 2018**

(51) **LOC (12) Cl.** **10-04**

(52) **U.S. Cl.**
USPC **D10/70; D10/38; D10/78; D10/98;**
D14/344; D24/167

(58) **Field of Classification Search**

USPC **D10/30-39, 65, 70, 78, 97, 98; D11/3;**
D14/138 R, 203.5, 203.6, 341, 344;
D24/167, 186

CPC **G04B 37/221; G04B 47/008; G04B 47/06;**
G04B 47/061; G04B 47/063; G04B
47/065; G04B 19/00-19/34; G04B 21/12;
G04B 23/12; G04B 37/00-37/228; G04B
47/00-47/068; G06F 19/3481; G06F
3/00-3/027; G06F 1/163; G01P 1/02;
G01P 1/12; G01P 1/00-1/26; G01P
15/00-15/18; A63B 24/0062; A63B
69/0028; A63B 2071/0663; A63B
2220/836; A63B 2225/50; A63B
24/00-2024/0096; A63B 2213/00; A63B
2071/0658-2071/0666; A63B
2220/00-2220/89; A63B 2225/02; A61B
5/681; A61B 5/6824; A61B 5/6825; A61B
5/6826; G01C 17/00; G01C
21/00-21/3697; G01C 22/00-22/025;

(Continued)

(56) **References Cited**

U.S. PATENT DOCUMENTS

D456,284 S * 4/2002 Wilson D10/30
D474,981 S * 5/2003 Wilson D10/32

(Continued)

Primary Examiner — Antoine Duval Davis

(74) *Attorney, Agent, or Firm* — Danielson Legal LLC;
Jordana Goodman

(57) **CLAIM**

The ornamental design for a wearable coaching device, as shown and described.

DESCRIPTION

The patent or application file contains at least one drawing executed in color. Copies of this patent or patent application publication with color drawing(s) will be provided by the Office upon request and payment of the necessary fee.

FIG. 1 is a perspective view of an embodiment of a wearable coaching device showing the new design;

FIG. 2 is a top view thereof;

FIG. 3 is a bottom view thereof;

FIG. 4 is a left side view thereof;

FIG. 5 is a right side view thereof;

FIG. 6 is a back side view thereof;

FIG. 7 is a front side view thereof;

FIG. 8 is a perspective view of another embodiment of a wearable coaching device showing the new design, including a yellow color portion;

FIG. 9 is a top view thereof;

FIG. 10 is a bottom view thereof;

FIG. 11 is a left side view thereof;

FIG. 12 is a right side view thereof;

FIG. 13 is a back side view thereof; and,

FIG. 14 is a front side view thereof.

(Continued)

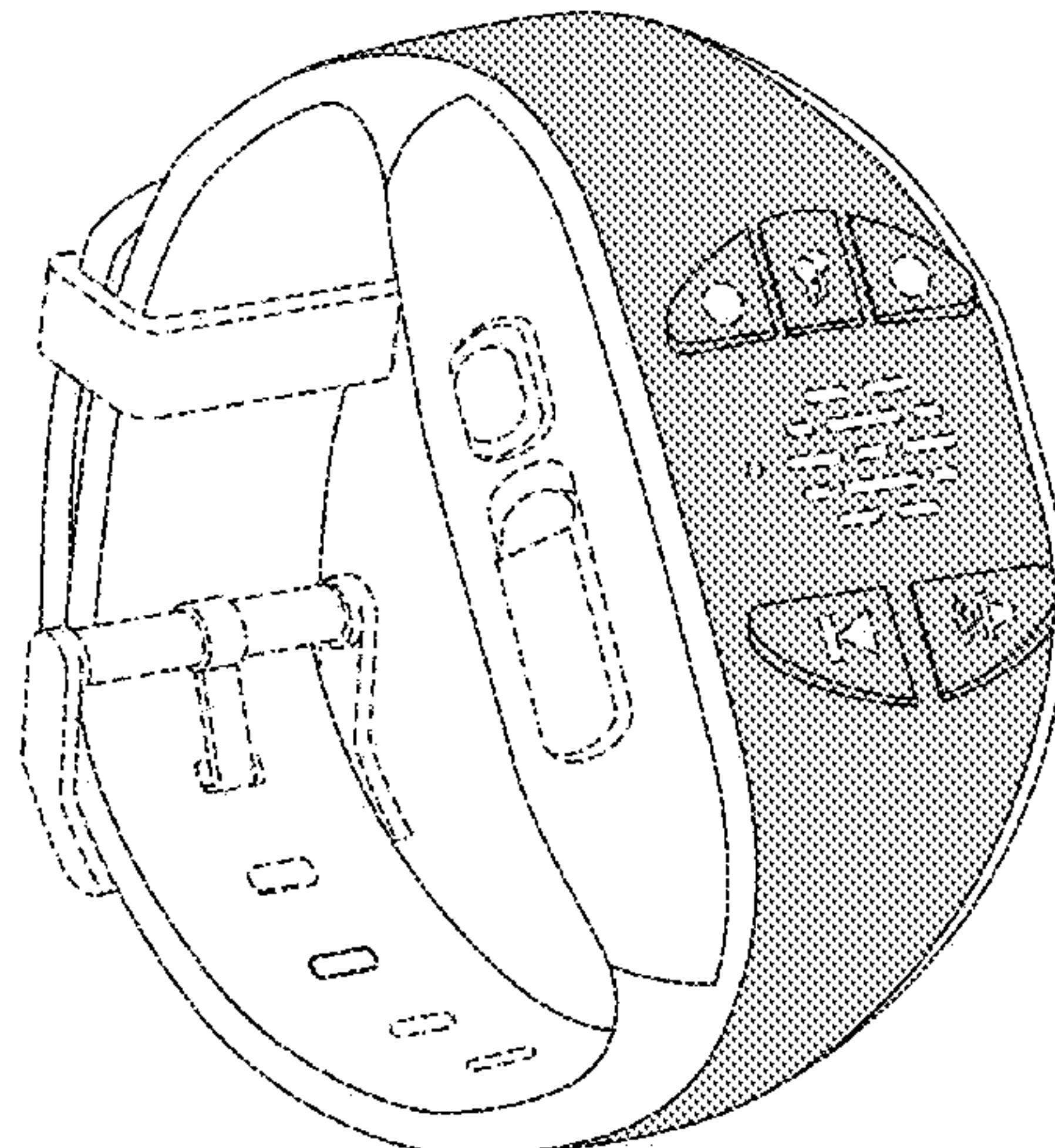

The broken lines represent portions of the article that form no part of the claim.

**1 Claim, 12 Drawing Sheets
(12 of 12 Drawing Sheet(s) Filed in Color)**

(58) **Field of Classification Search**

CPC G01C 23/00–23/005; G01C 21/16; A63C
11/02; G04G 21/00; G04G 21/02; G04G
21/08

See application file for complete search history.

(56) **References Cited**

U.S. PATENT DOCUMENTS

D501,639	S	*	2/2005	Modolo	D10/32
D512,921	S	*	12/2005	Wilson	D10/30
D660,185	S	*	5/2012	Schrepfer	D10/32
D728,409	S	*	5/2015	Bar-Am	D11/3
D730,347	S	*	5/2015	Jung	D14/344
D737,699	S	*	9/2015	Chang	D10/39
D749,965	S	*	2/2016	Lutgen	D10/126
D780,602	S	*	3/2017	Heleniak	D10/38
D820,124	S	*	6/2018	Mouradian	D10/70

* cited by examiner

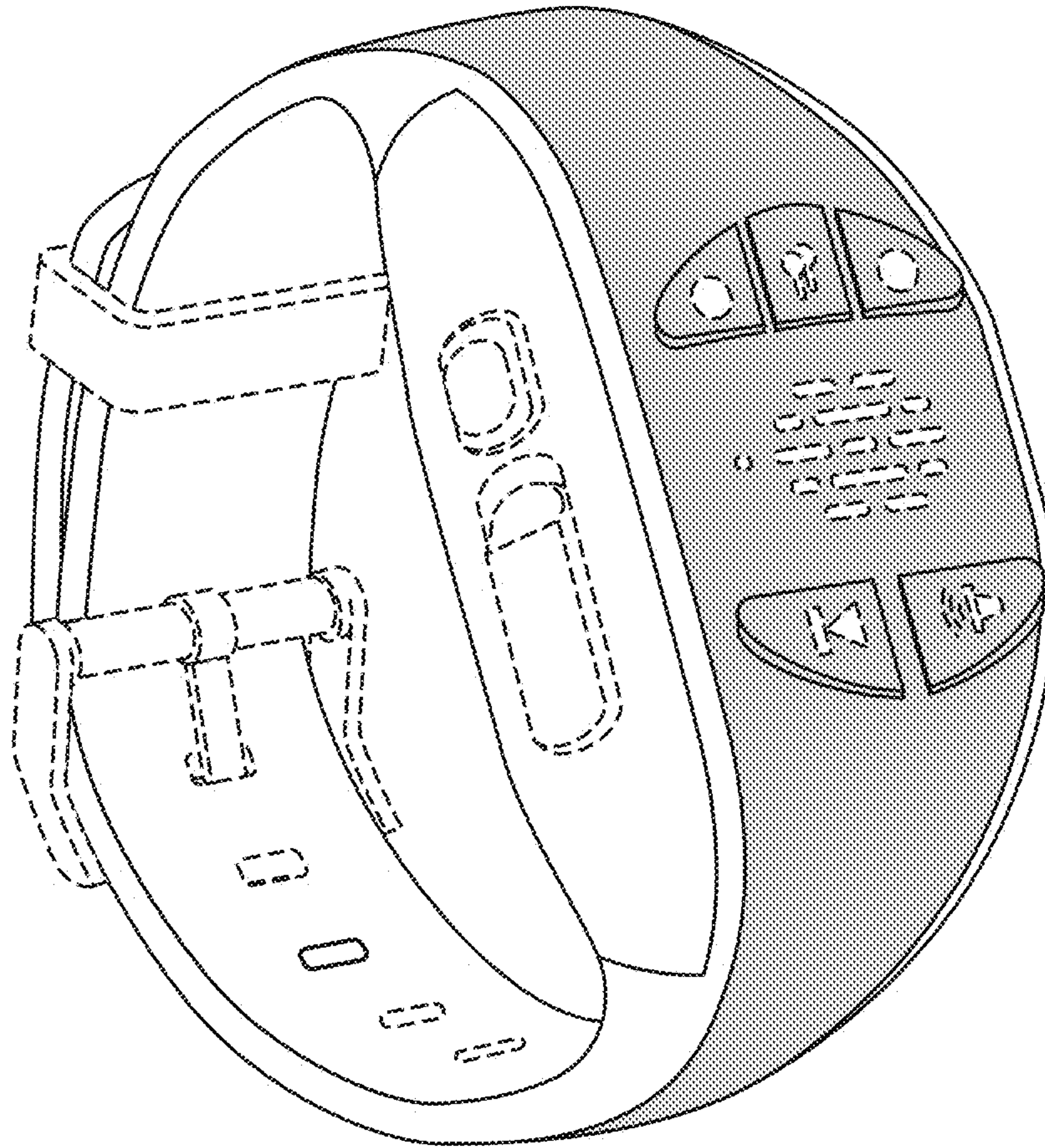

FIG. 1

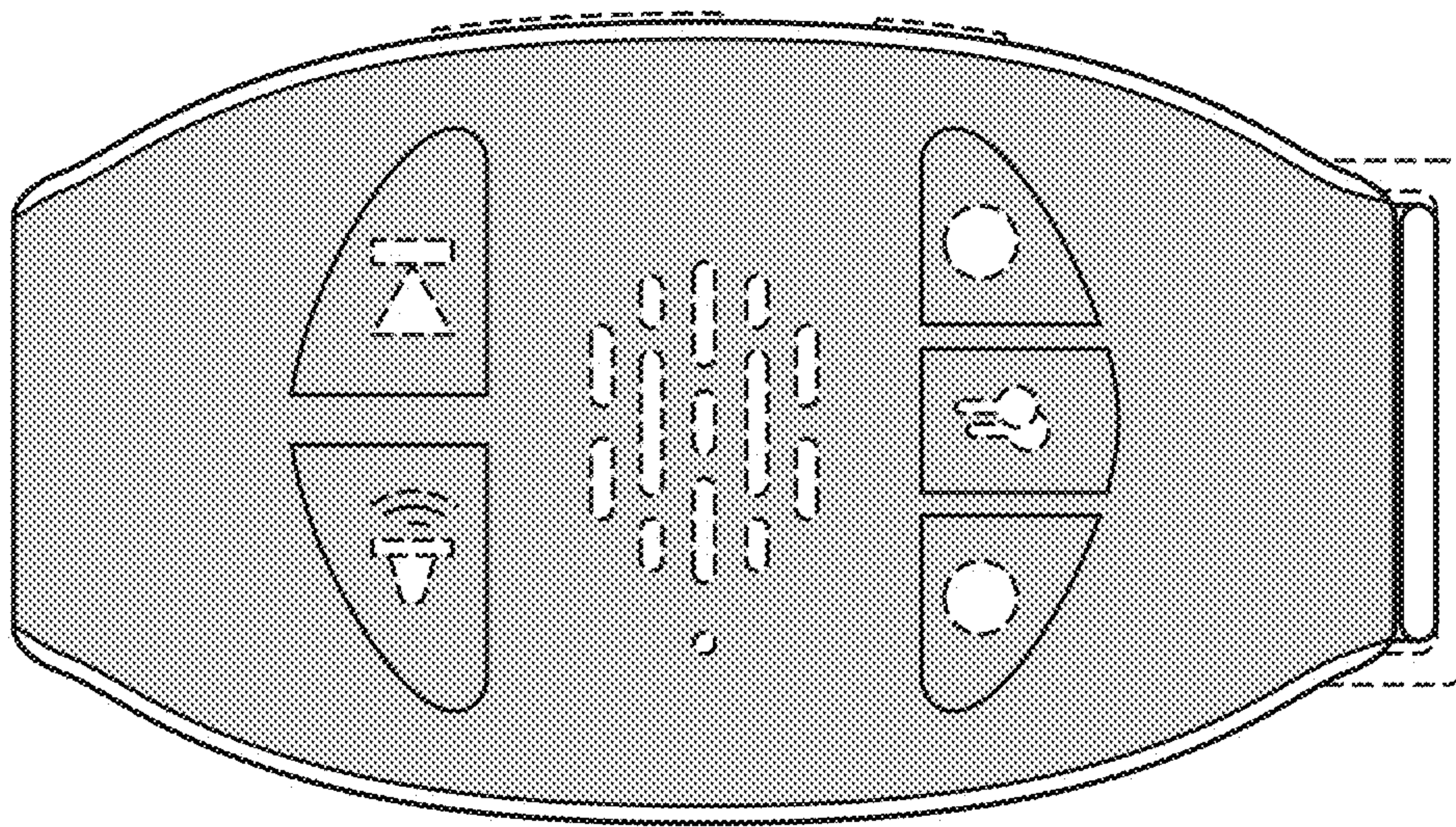

FIG. 2

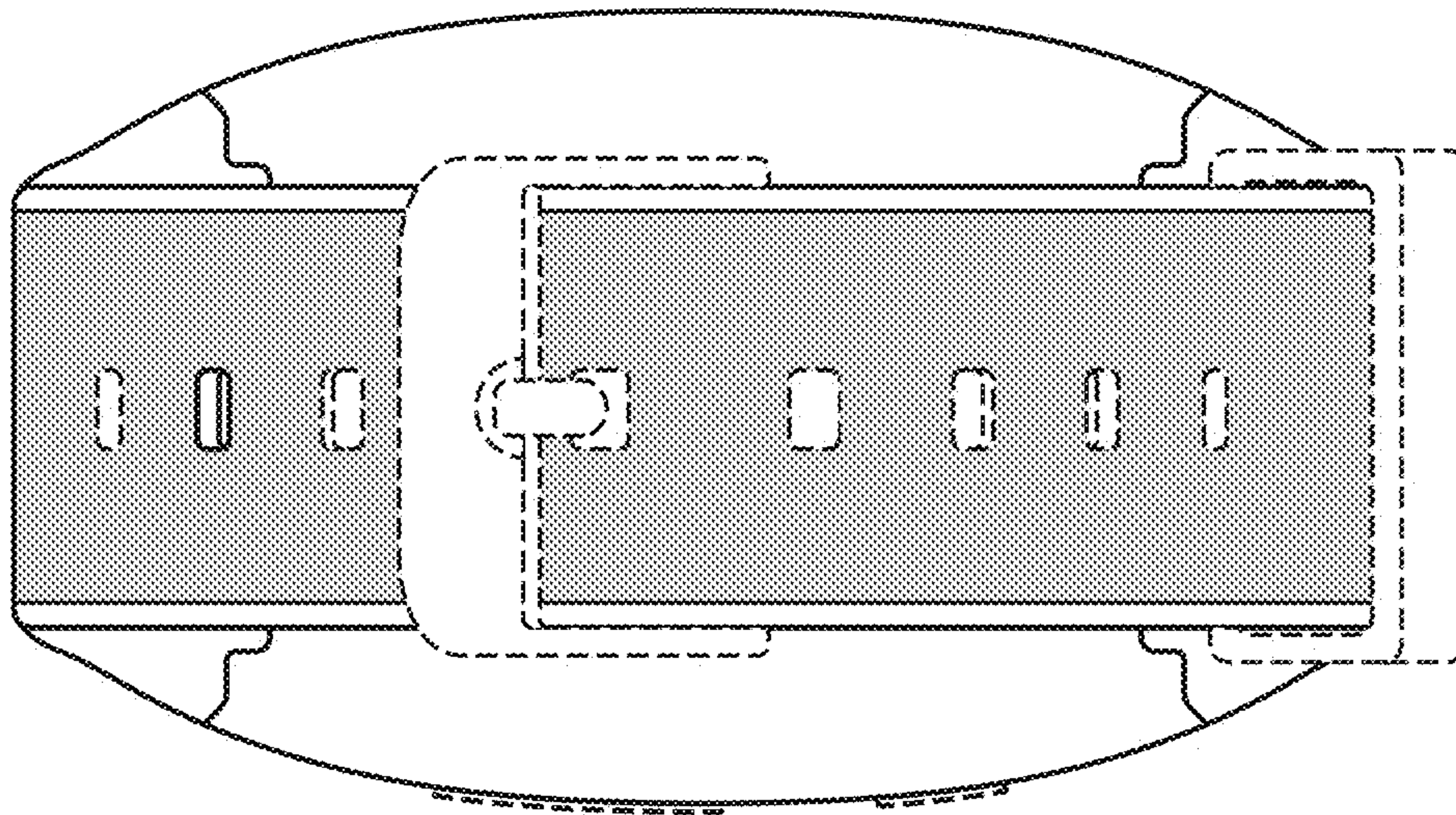

FIG. 3

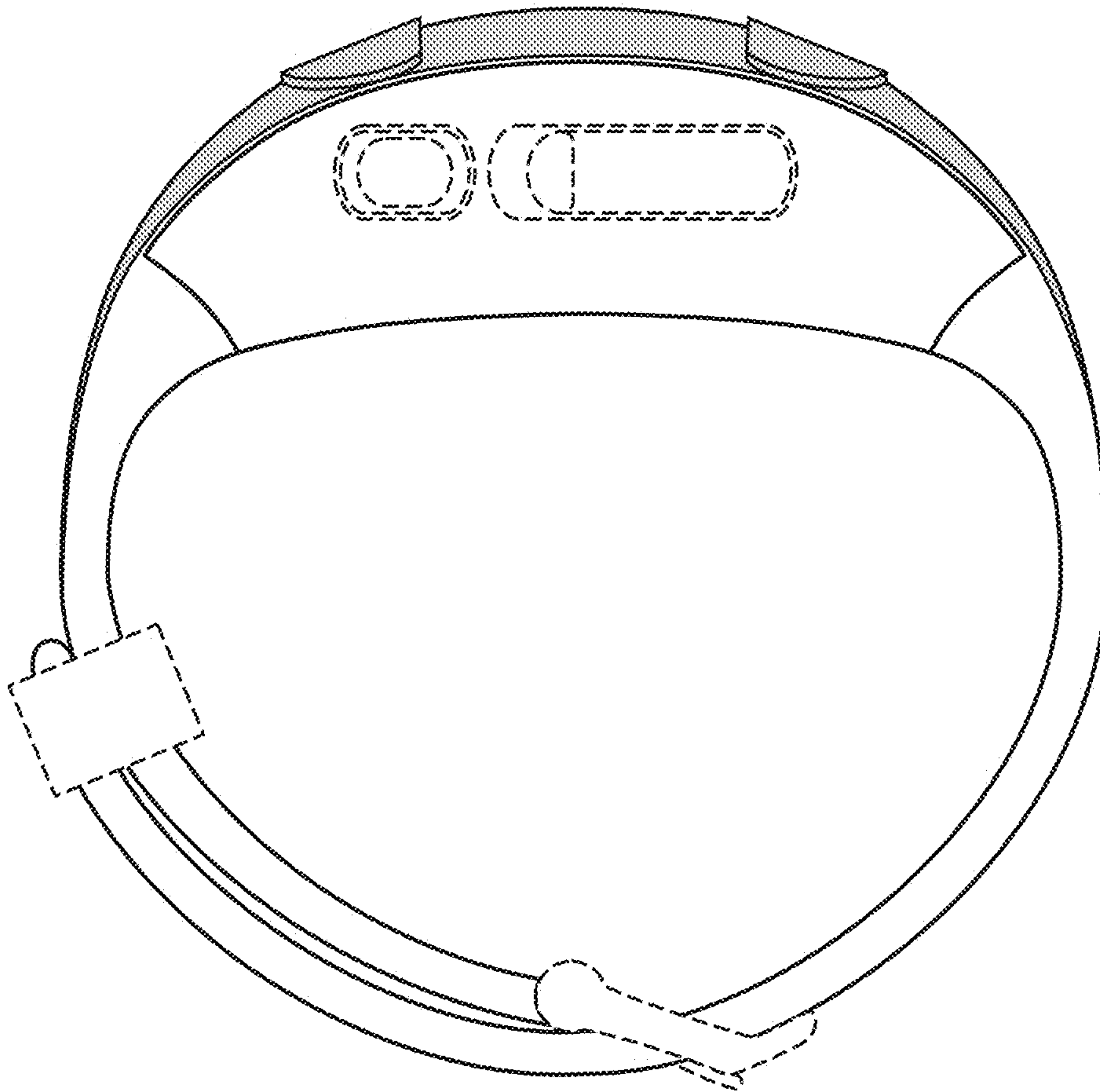

FIG. 4

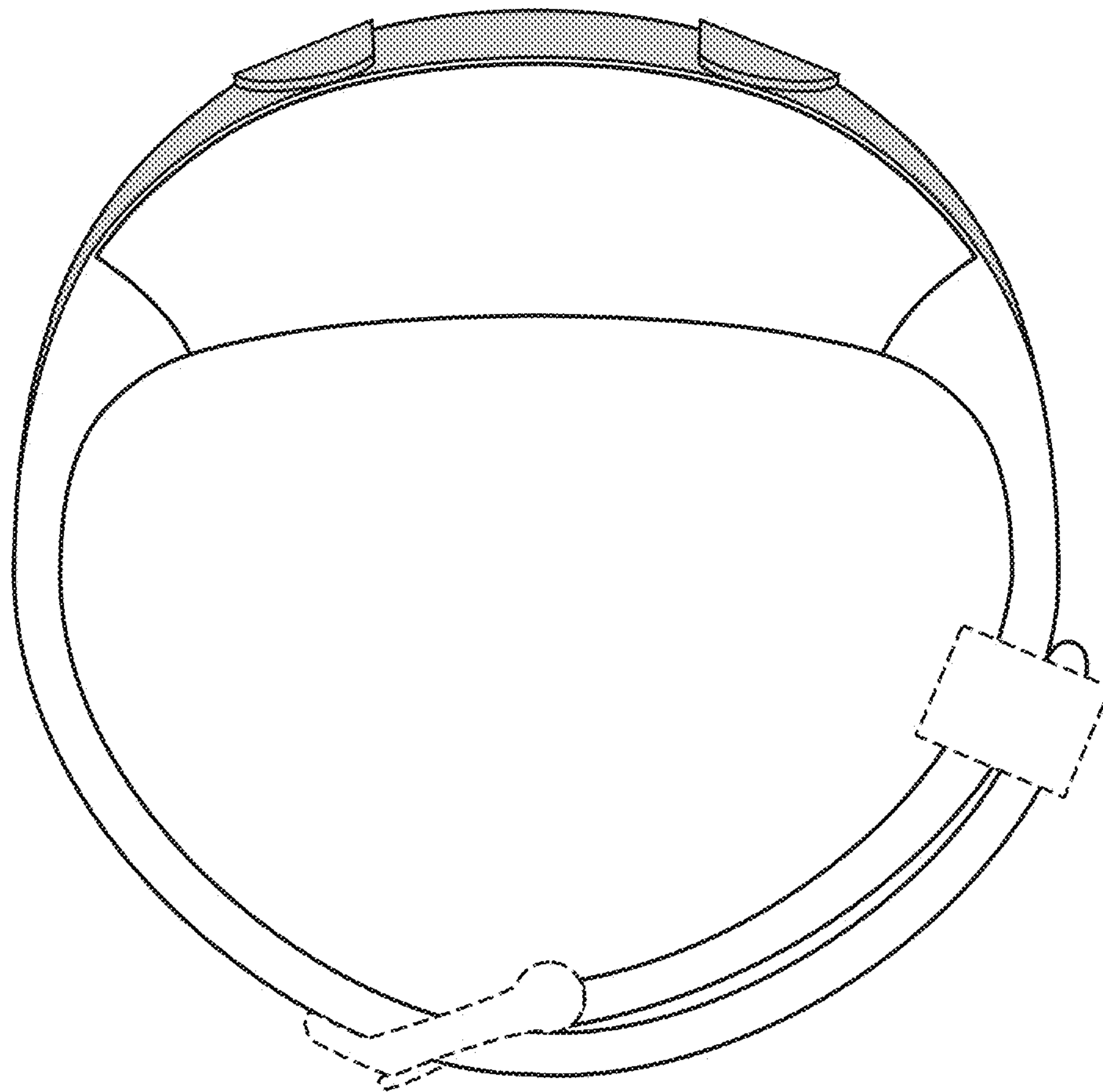

FIG. 5

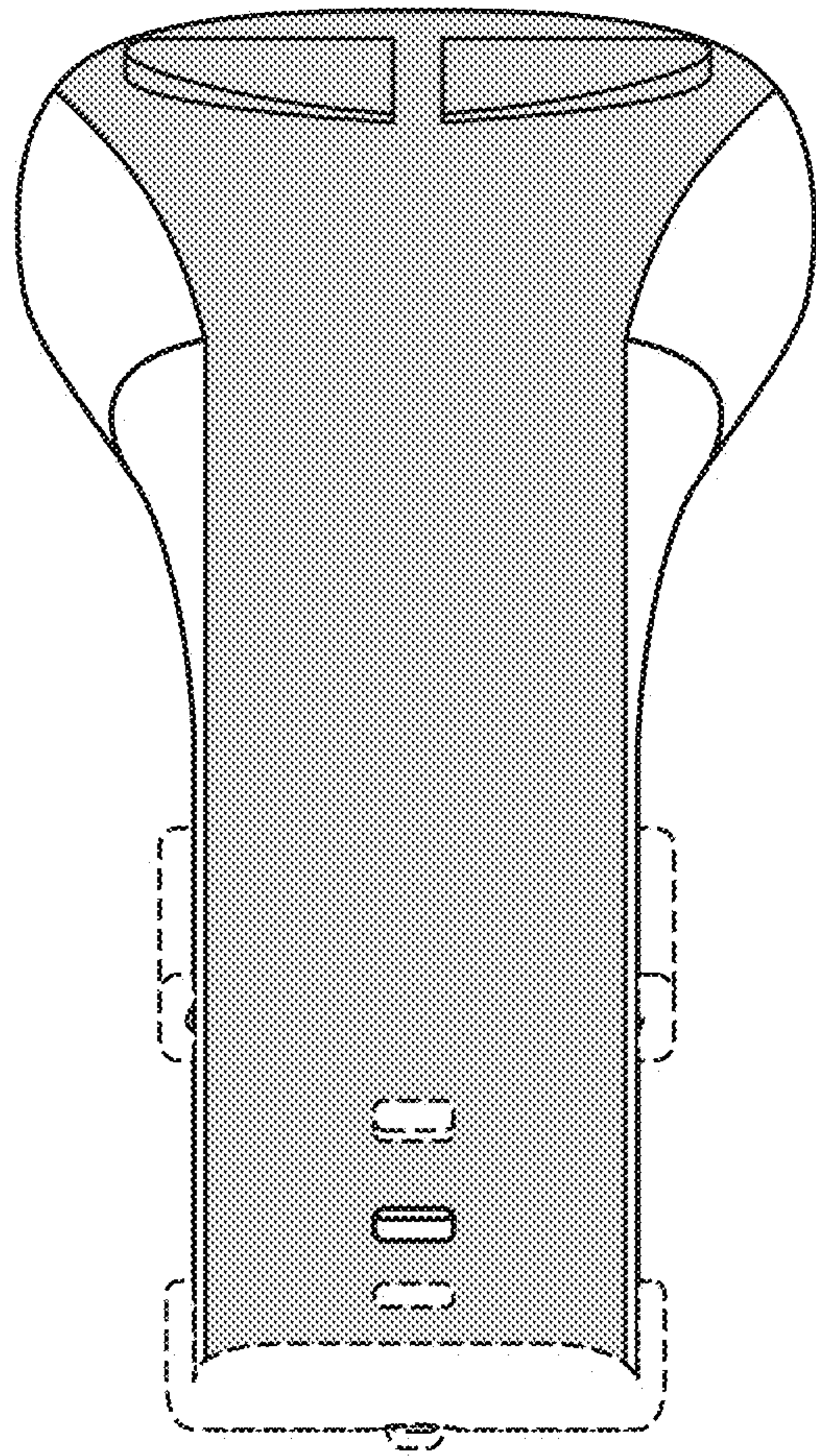

FIG. 6

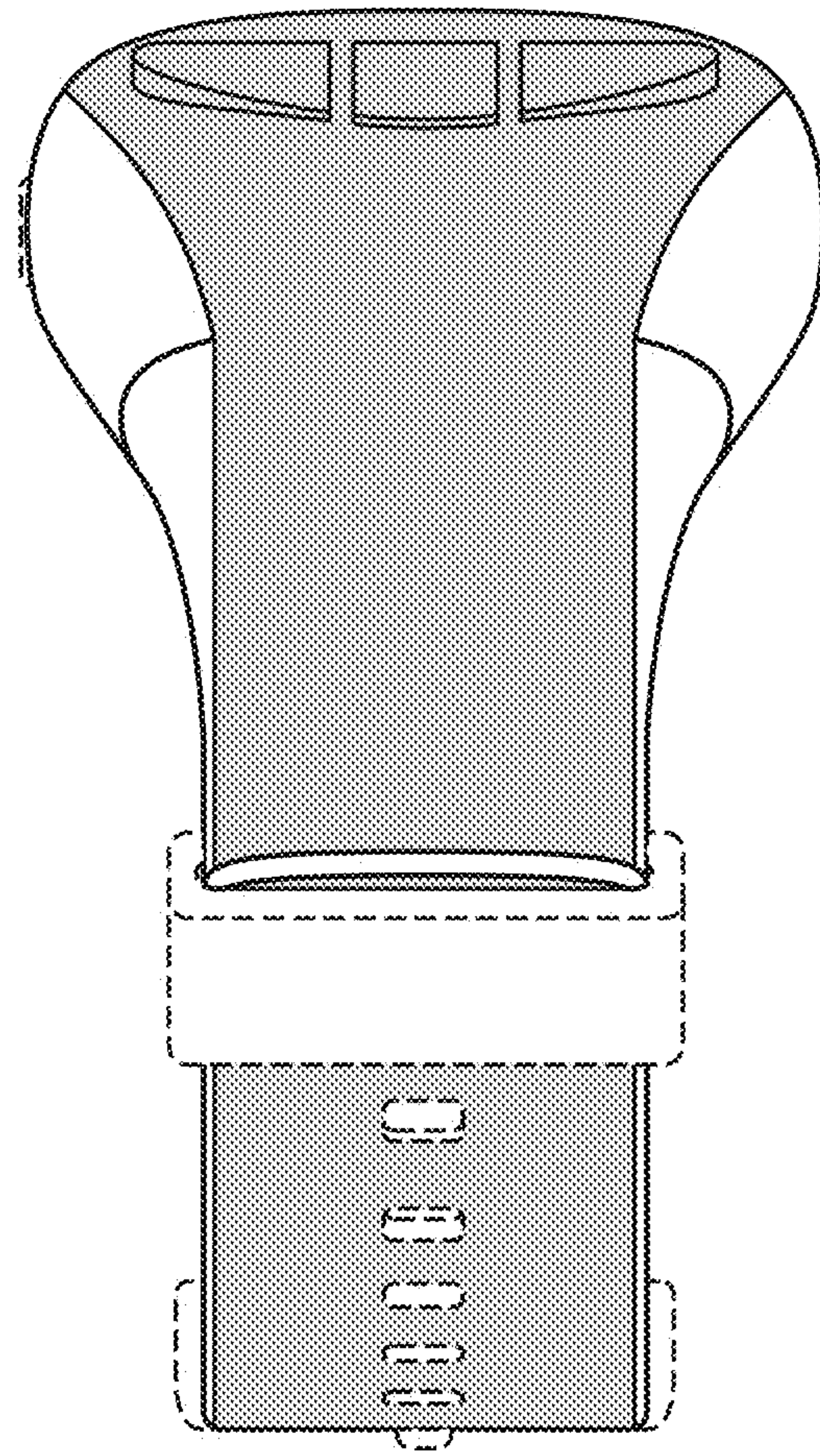

FIG. 7

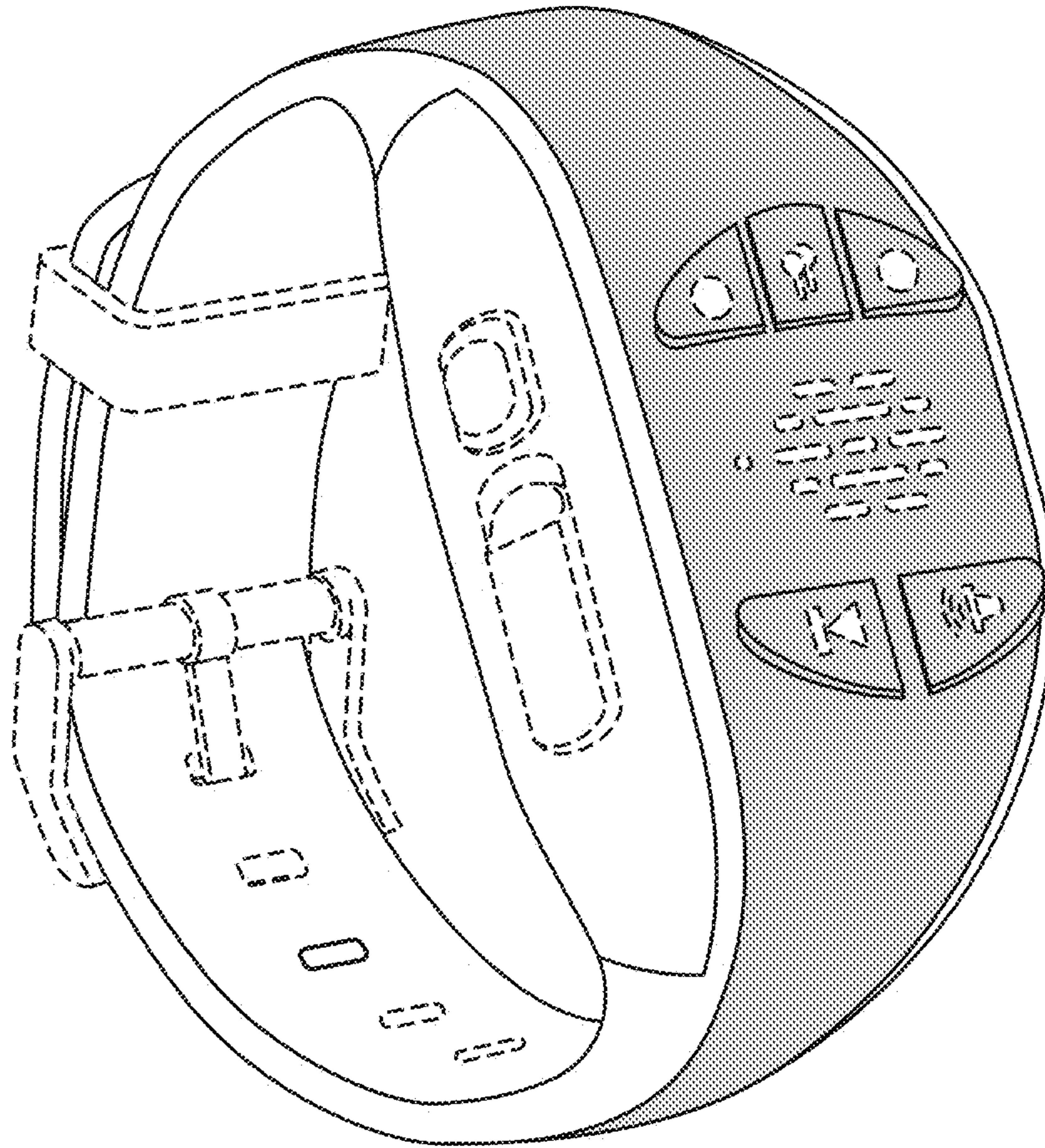

FIG. 8

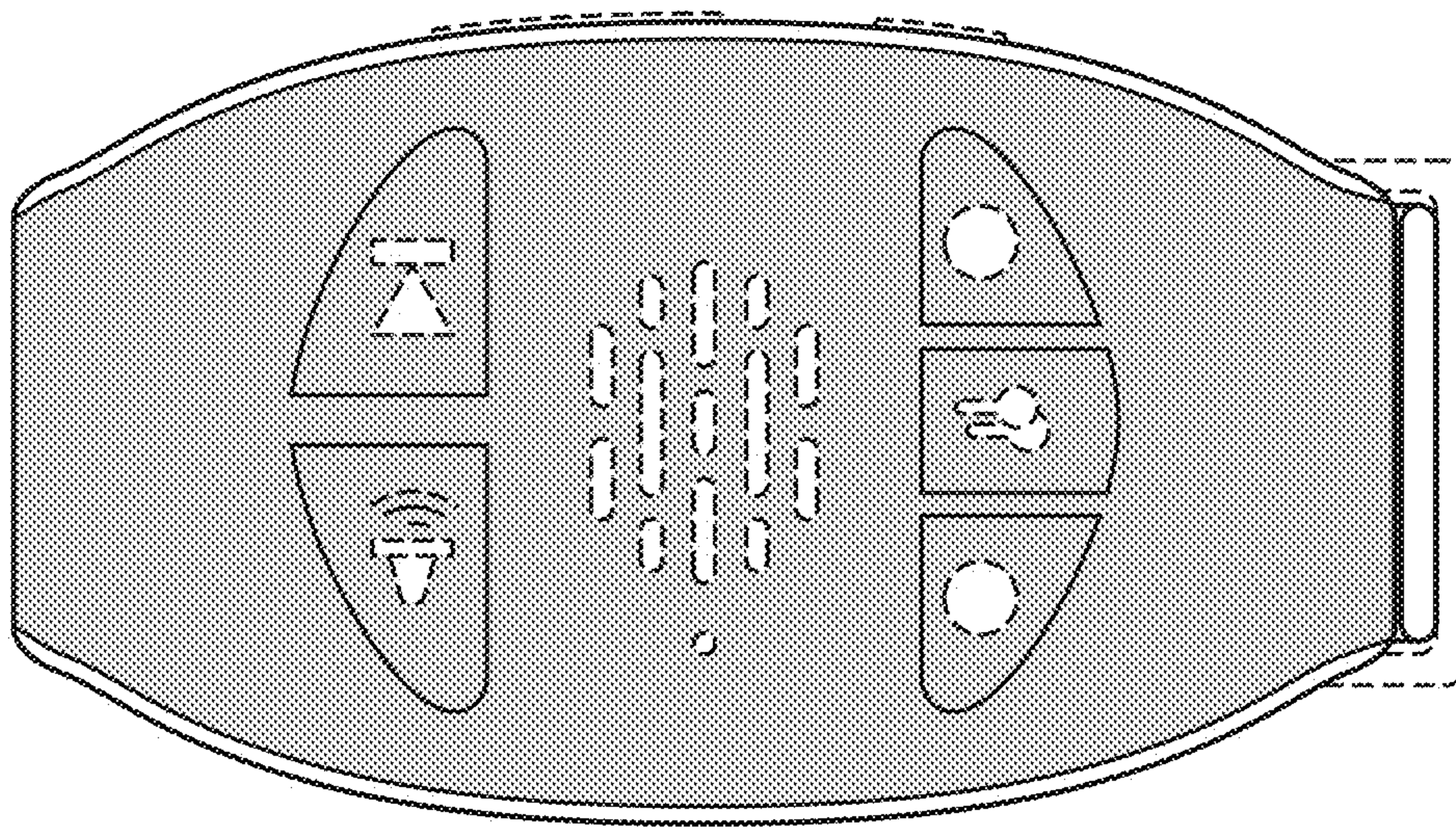

FIG. 9

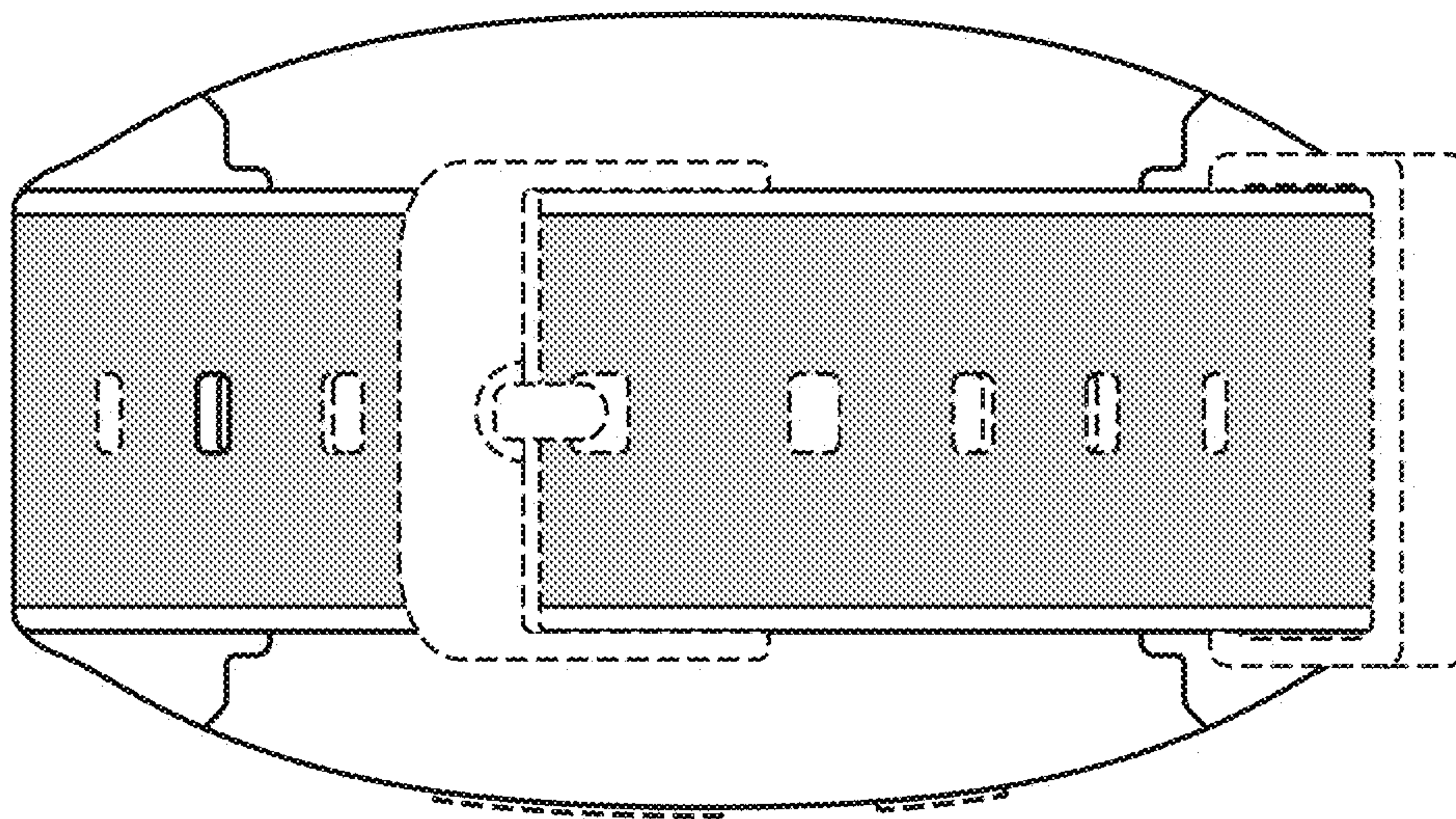

FIG. 10

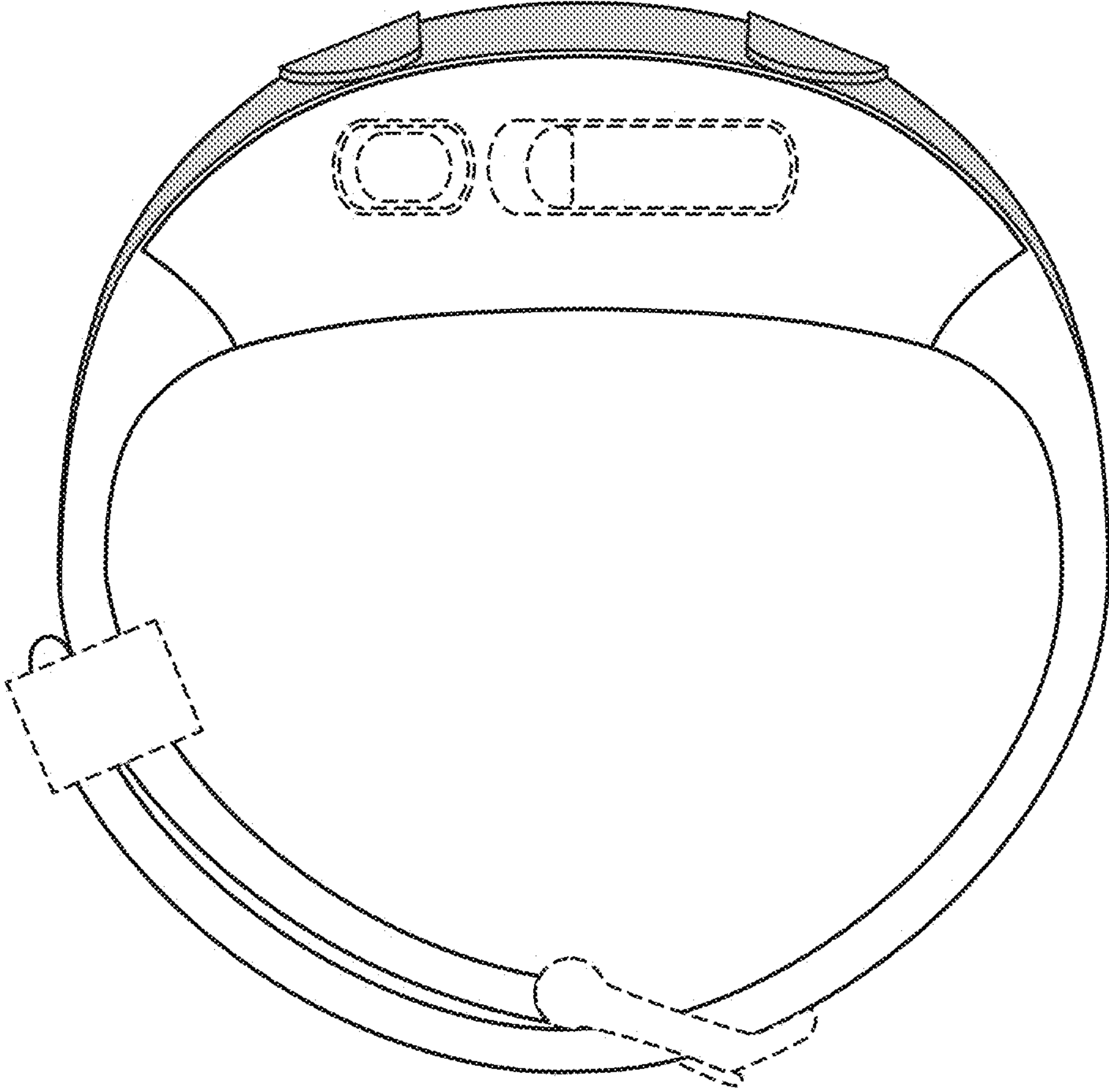

FIG. 11

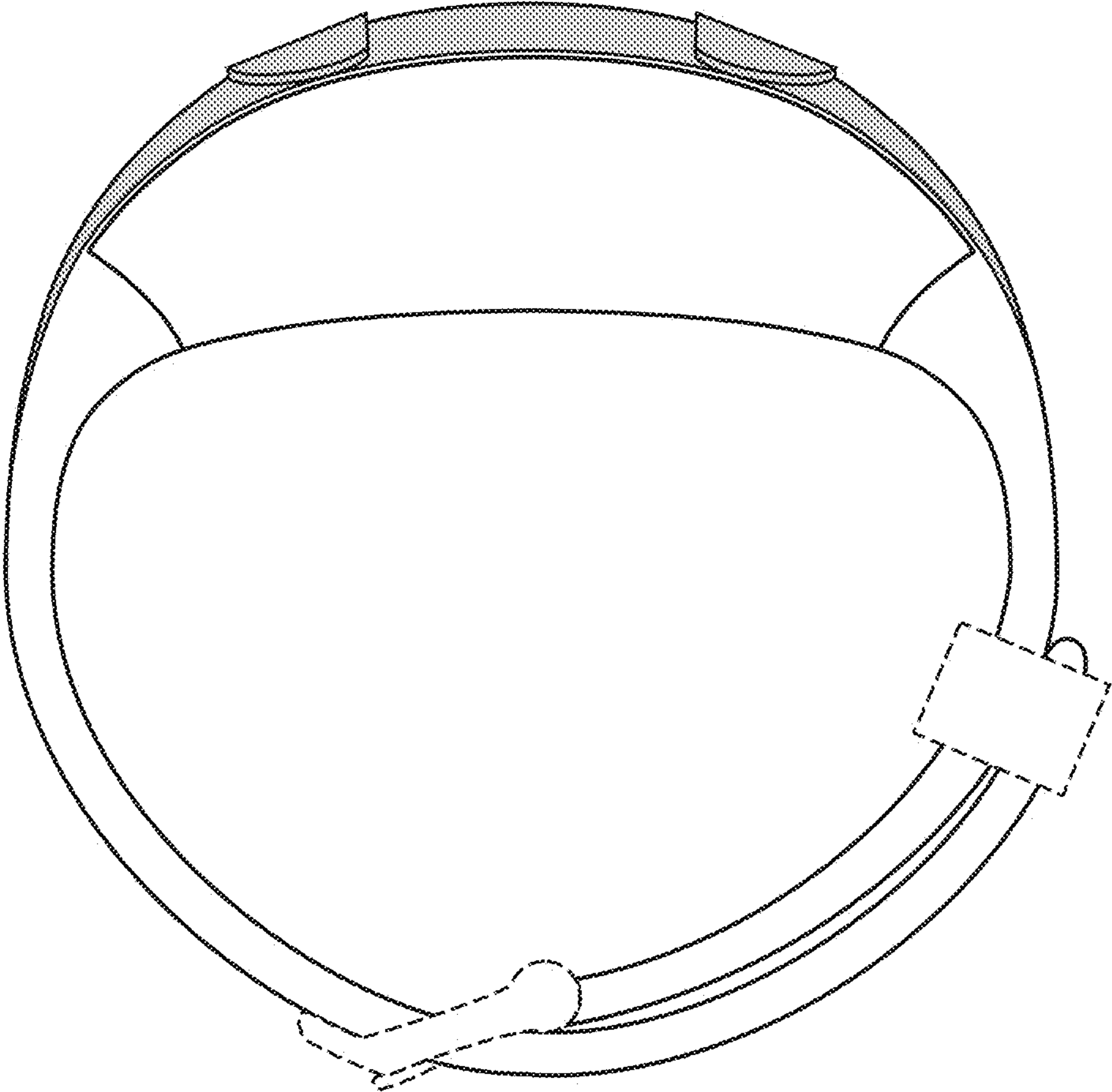

FIG. 12

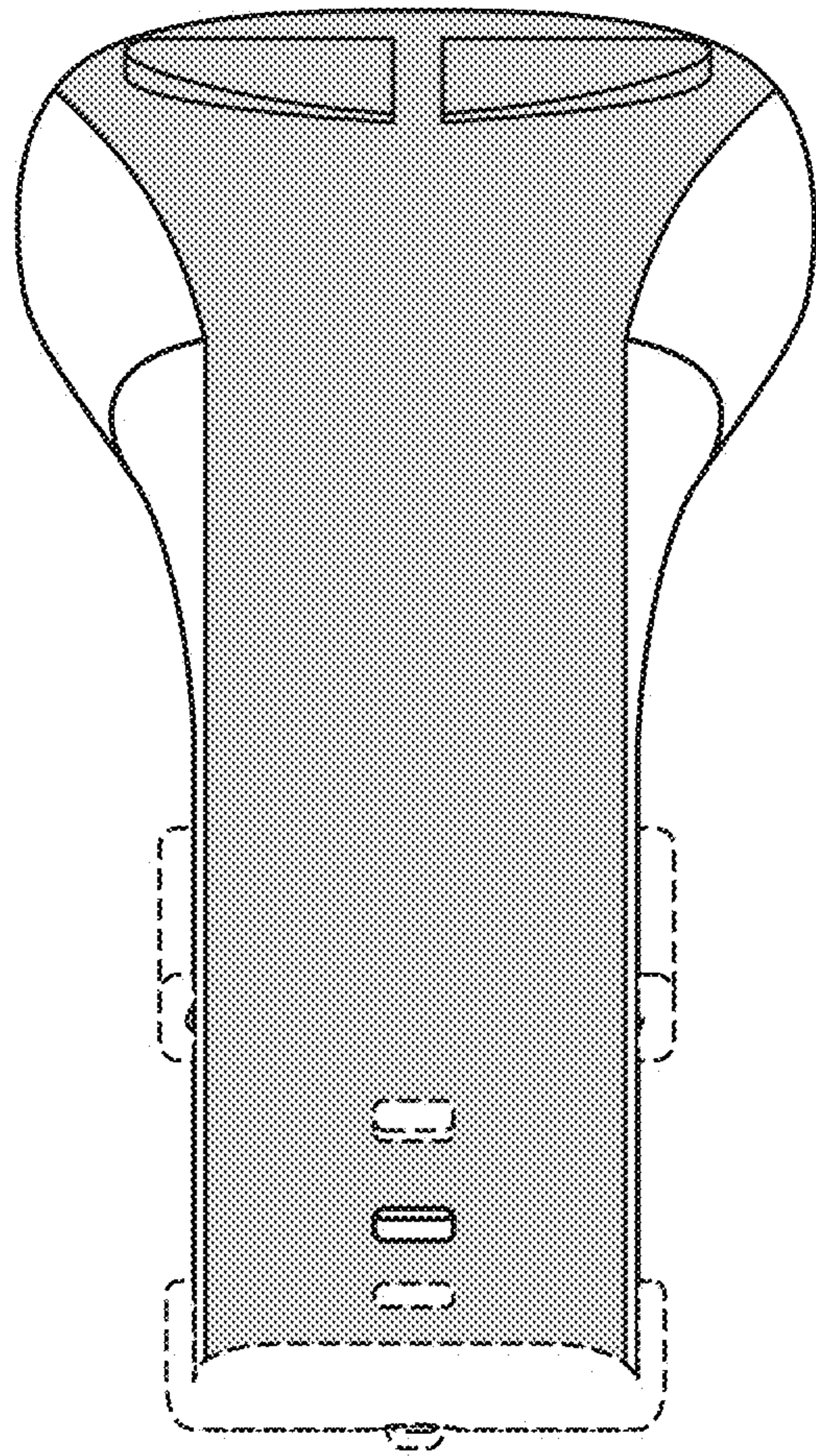

FIG. 13

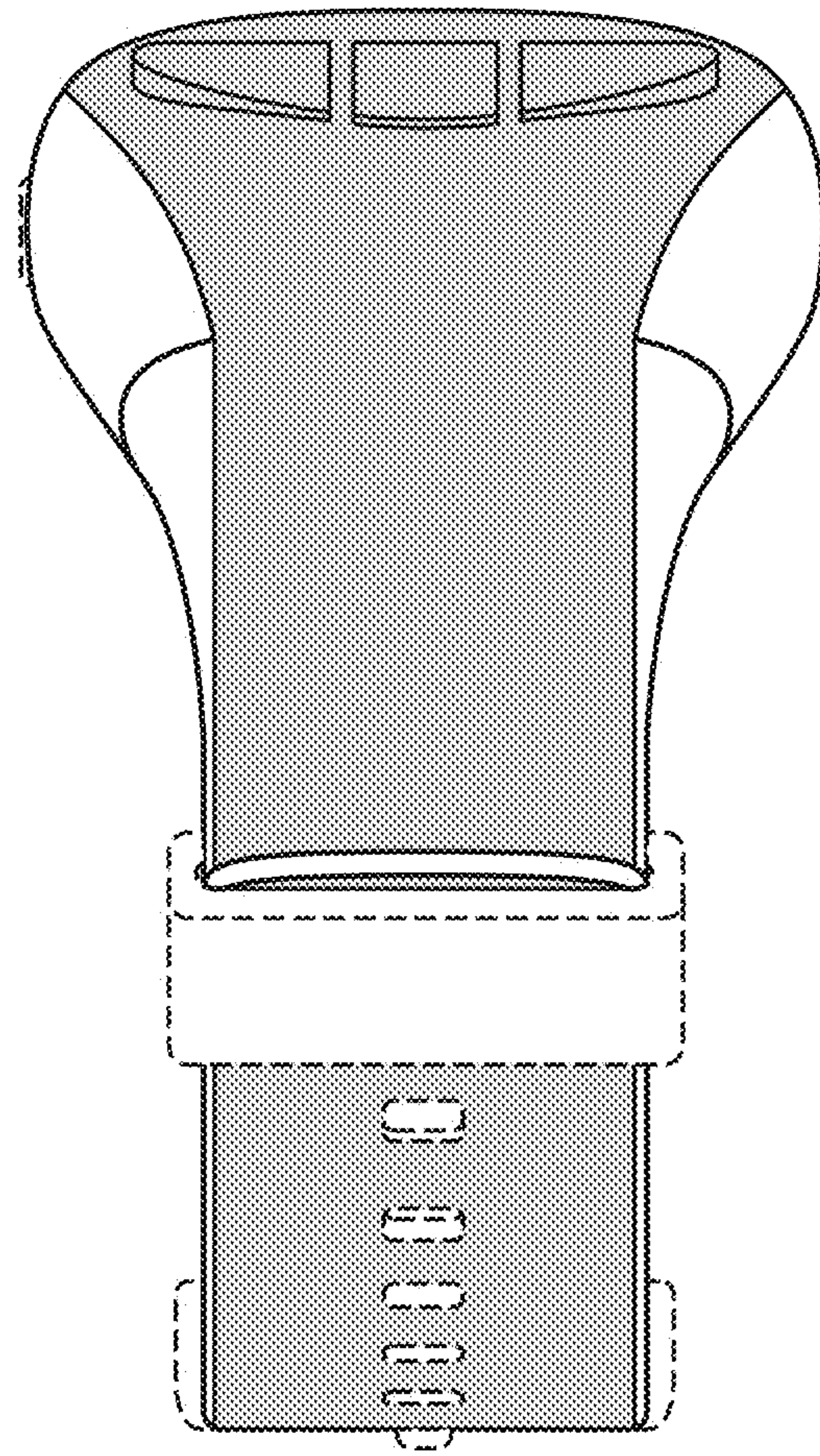

FIG. 14