



US00D885900S

(12) **United States Design Patent**  
**Edie et al.**

(10) **Patent No.:** **US D885,900 S**

(45) **Date of Patent:** **\*\* \*Jun. 2, 2020**

(54) **CLOSURE**

(71) Applicant: **Closure Systems International Inc.**,  
Memphis, TN (US)

(72) Inventors: **John Edie**, Crawfordsville, IN (US);  
**Jamison D. Woodley**, Indianapolis, IN  
(US); **Daniel H. Shulman**, Northbrook,  
IL (US)

(73) Assignee: **Closure Systems International Inc.**,  
Memphis, TN (US)

(\*) Notice: This patent is subject to a terminal dis-  
claimer.

(\*\*) Term: **15 Years**

(21) Appl. No.: **29/632,116**

(22) Filed: **Jan. 5, 2018**

(51) **LOC (12) Cl.** ..... **09-07**

(52) **U.S. Cl.**  
USPC ..... **D9/452**

(58) **Field of Classification Search**

USPC ..... D7/387, 391, 392, 396.1, 396.2, 398,  
D7/900; D9/438, 449, 452, 453, 454,  
D9/414-435, 457, 499, 682, 685, 686,  
D9/688, 723, 724, 763, 772; D12/197;  
D24/121, 127, 224; D28/76, 78, 82;  
D19/34.1, 162, 163, 164, 165, 192, 194  
CPC ..... B65D 51/18; B65D 51/28; B65D 51/242;  
B65D 51/2814; B65D 51/2821; B65D  
21/0228; B65D 41/3447; B65D 1/0246;  
B65D 1/02; B65D 2251/0018; B65D  
2251/0026; B65D 2251/009; B65D 55/02;  
B65D 55/024; A47G 19/22; A47G  
19/2205; A47G 19/2222; A47G 19/2266;  
A47G 19/2272; A47G 19/2294; A47J  
43/27; A47J 36/06; A47J 36/10; A47J  
36/14

See application file for complete search history.

(56) **References Cited**

U.S. PATENT DOCUMENTS

5,487,481 A \* 1/1996 Sander ..... B65D 41/3447  
215/252  
5,725,116 A \* 3/1998 Takai ..... B65D 41/3409  
215/252  
D407,978 S \* 4/1999 Petro ..... D9/453  
(Continued)

FOREIGN PATENT DOCUMENTS

EM 001858002 S 5/2011  
WO 2014060893 A1 4/2014  
WO 2017139902 A2 8/2017

OTHER PUBLICATIONS

Aqua Lok Mini: Site Visited Dec. 27, 2018. Available from Internet  
URL: <http://csiclosures.com/markets-served/beverages/bottled-water/aqua-lok-mini-26mm-tc?s=capfinder>.\*

(Continued)

*Primary Examiner* — Catherine S Posthauer

(74) *Attorney, Agent, or Firm* — Nixon Peabody LLP

(57) **CLAIM**

The ornamental design for a closure, as shown and  
described.

**DESCRIPTION**

FIG. 1 is a top perspective view of a closure, showing our  
new design.

FIG. 2 is a bottom perspective view of the closure of FIG.  
1.

FIG. 3 is a left side view of the closure of FIG. 1.

FIG. 4 is a right side view of the closure of FIG. 1.

FIG. 5 is a front view of the closure of FIG. 1.

FIG. 6 is a back view of the closure of FIG. 1.

FIG. 7 is a top view of the closure of FIG. 1; and,

FIG. 8 is a bottom view of the closure of FIG. 1.

(Continued)

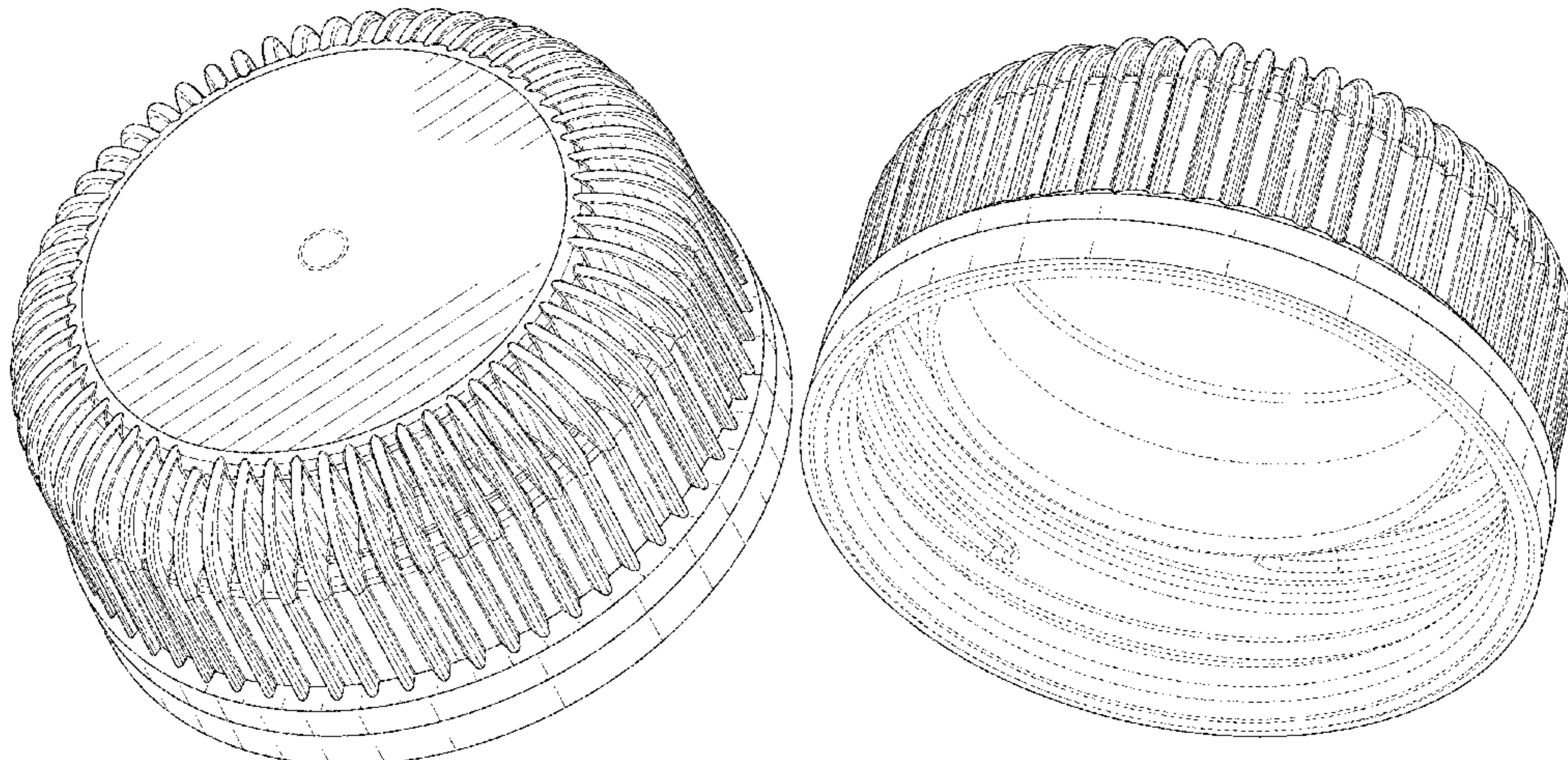

The broken lines are shown for the purpose of illustrating parts of the article that form no part of the claim.

**1 Claim, 6 Drawing Sheets**

(56)

**References Cited**

U.S. PATENT DOCUMENTS

D437,218 S \* 2/2001 Ljunstrom ..... D9/417  
 6,308,848 B1 \* 10/2001 Parrinello ..... B65D 41/3428  
 215/252  
 D458,138 S \* 6/2002 Fuchs ..... D9/453  
 6,405,886 B1 \* 6/2002 Gearhart ..... B65D 41/3428  
 215/252  
 D460,357 S \* 7/2002 Kras ..... D9/435  
 D465,731 S \* 11/2002 Brant ..... D9/453  
 D518,717 S \* 4/2006 German ..... D9/453  
 D574,240 S \* 8/2008 Szczesniak ..... D9/453  
 D584,149 S \* 1/2009 Lohrman ..... D9/453  
 D606,864 S \* 12/2009 Robinson ..... D9/453  
 D619,003 S \* 7/2010 Benoit-Gonin ..... D9/453  
 D632,958 S \* 2/2011 Fuchs ..... D9/453  
 D634,200 S \* 3/2011 Taber ..... D9/453  
 D671,834 S \* 12/2012 Chasteen ..... D9/453  
 D687,299 S 8/2013 Peykoff et al.  
 D693,221 S \* 11/2013 Ramsey ..... D9/453  
 D693,685 S \* 11/2013 Ramsey ..... D9/453  
 D723,919 S \* 3/2015 Taber ..... D9/438  
 9,181,001 B2 \* 11/2015 Molinaro ..... B65D 1/023  
 D762,115 S 7/2016 Corvaglia et al.  
 D789,201 S \* 6/2017 Yu ..... D9/453

D790,966 S \* 7/2017 Roberts ..... D9/453  
 D824,257 S 7/2018 Wood  
 D836,442 S \* 12/2018 Wood ..... D9/453  
 D838,171 S 1/2019 Wood  
 2009/0014404 A1 \* 1/2009 Russell ..... B65D 50/041  
 215/220  
 2011/0290754 A1 \* 12/2011 Taber ..... B65D 41/04  
 215/329  
 2011/0290755 A1 \* 12/2011 Taber ..... B65D 41/00  
 215/329  
 2012/0031871 A1 \* 2/2012 Molinaro ..... B65D 1/023  
 215/44  
 2013/0313218 A1 \* 11/2013 Cox ..... B65D 41/0485  
 215/246  
 2015/0122769 A1 \* 5/2015 Taber ..... B65D 51/145  
 215/350  
 2016/0288961 A1 \* 10/2016 Maguire ..... B65D 55/16  
 2017/0166360 A1 \* 6/2017 Falzoni ..... B65D 41/0421  
 2018/0079570 A1 \* 3/2018 Maguire ..... B65D 55/16  
 2018/0257822 A1 \* 9/2018 Neputy ..... B65D 41/0485  
 2018/0370701 A1 \* 12/2018 Maguire ..... B29C 45/0017

OTHER PUBLICATIONS

Betapack Pedrosa Cap: Site Visited Dec. 27, 2018. Available from Internet URL: <https://www.betapack.com/en/site/caps/11/pedrosa>.  
 Betapack Cap: Site Visited Dec. 27, 2018. Available from Internet URL: <https://www.betapack.com/en/site/caps/35/30-25-a>.  
 Tamper Evident Cap: Announced Sep. 10, 2017 [online]. Site Visited Dec. 27, 2018. Available from Internet URL: <https://catalog.berryglobal.com/products/closure/closure-tamper-evident/closure778ce2626pfg3>.

\* cited by examiner

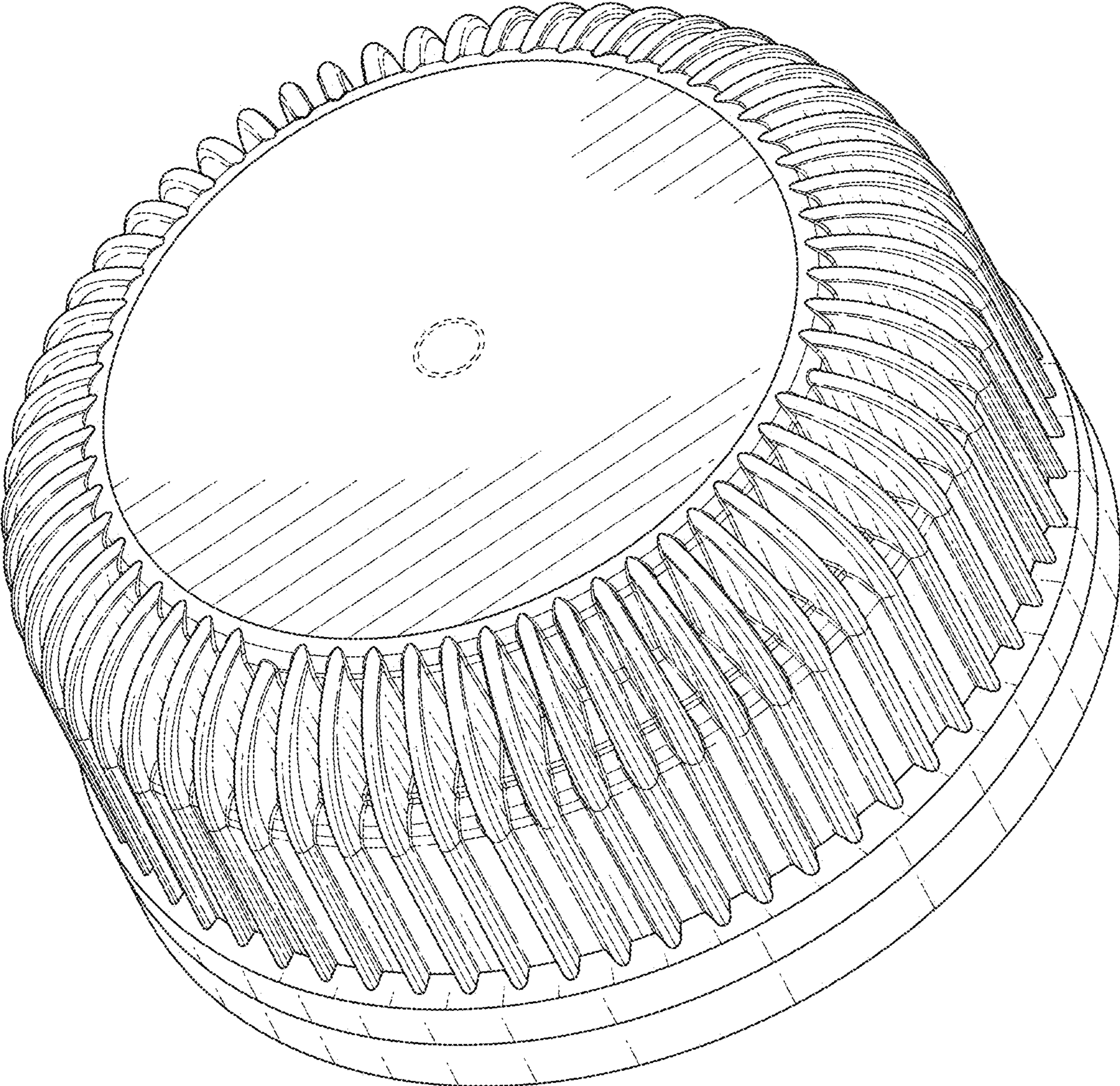

FIG. 1

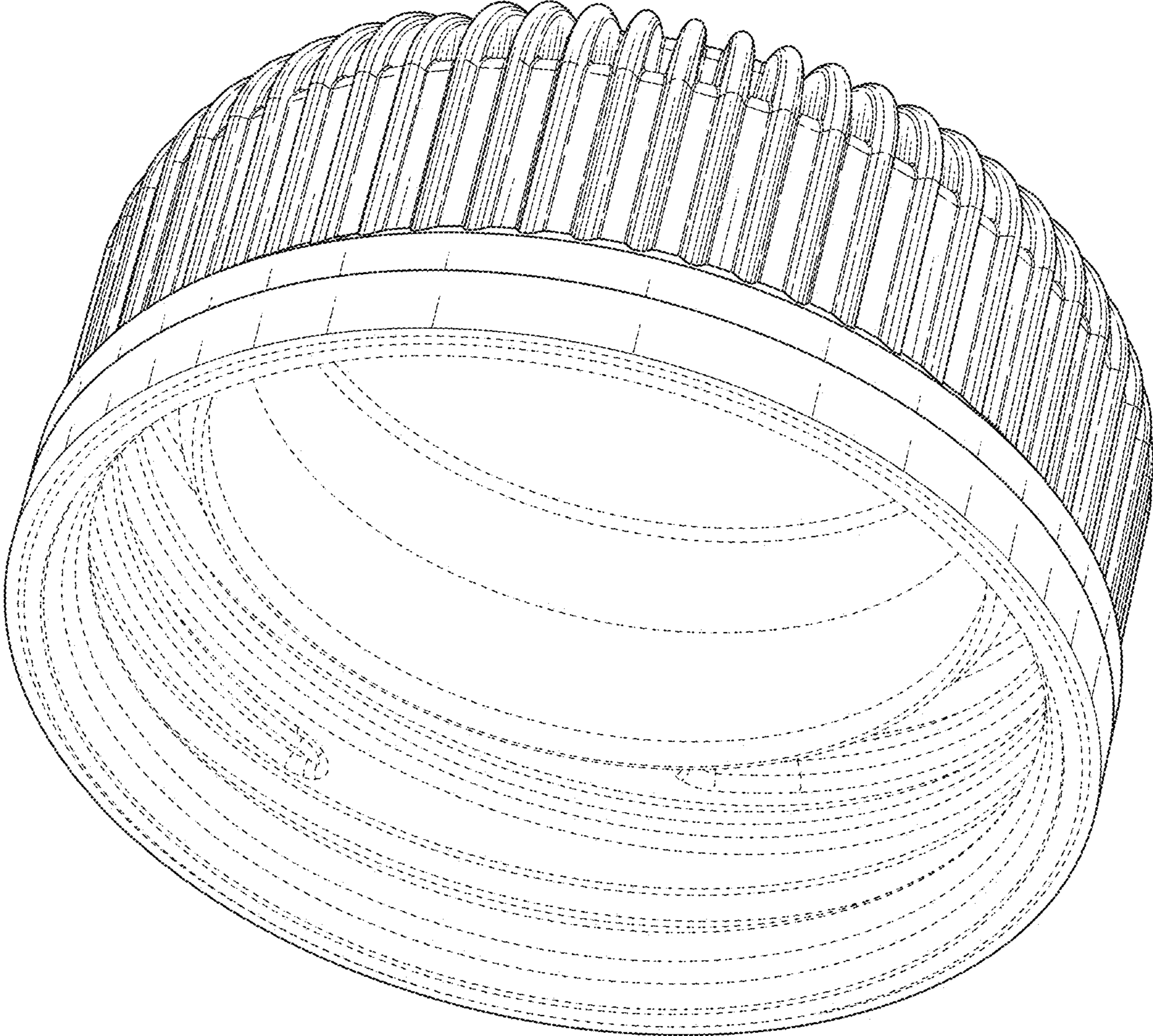

FIG. 2

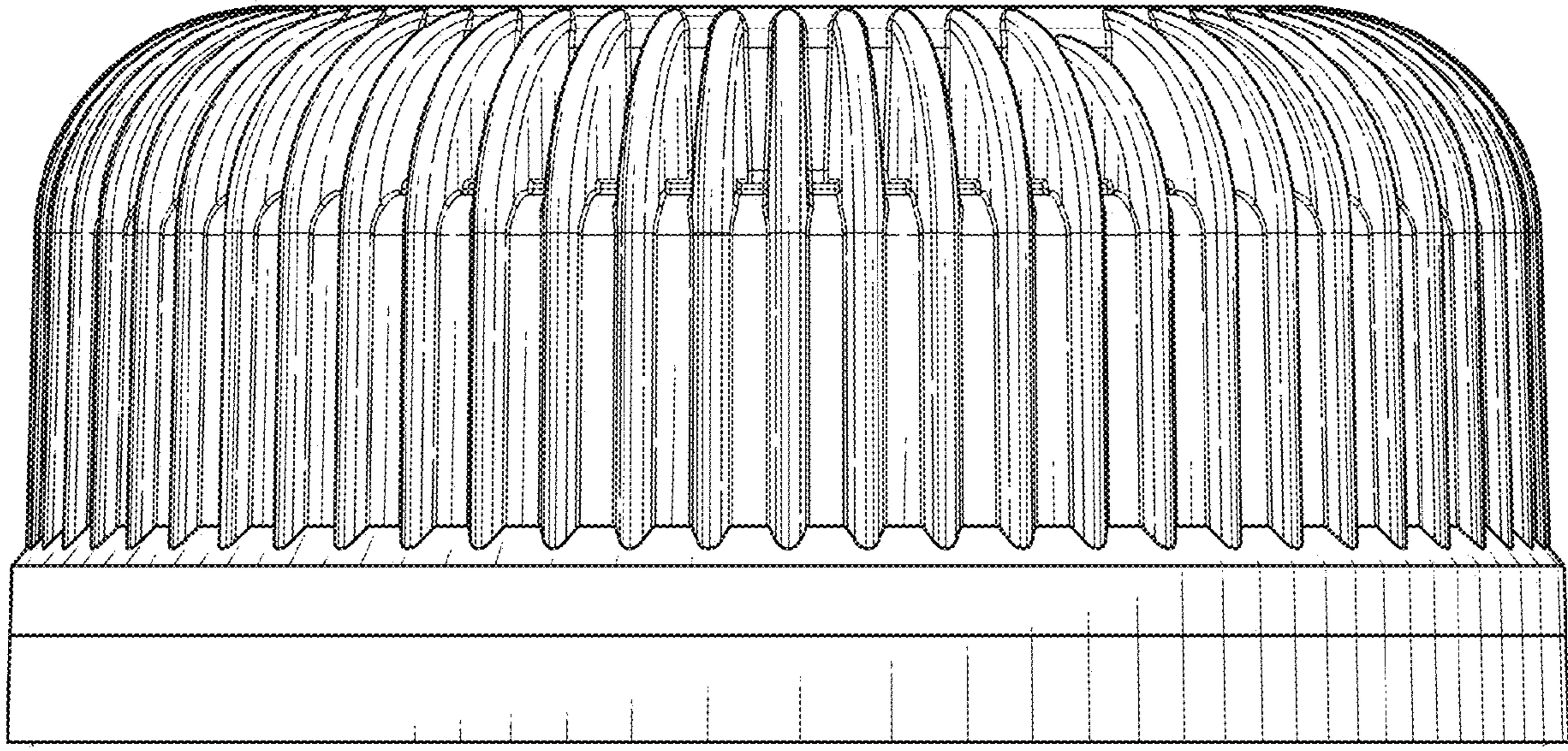

FIG. 3

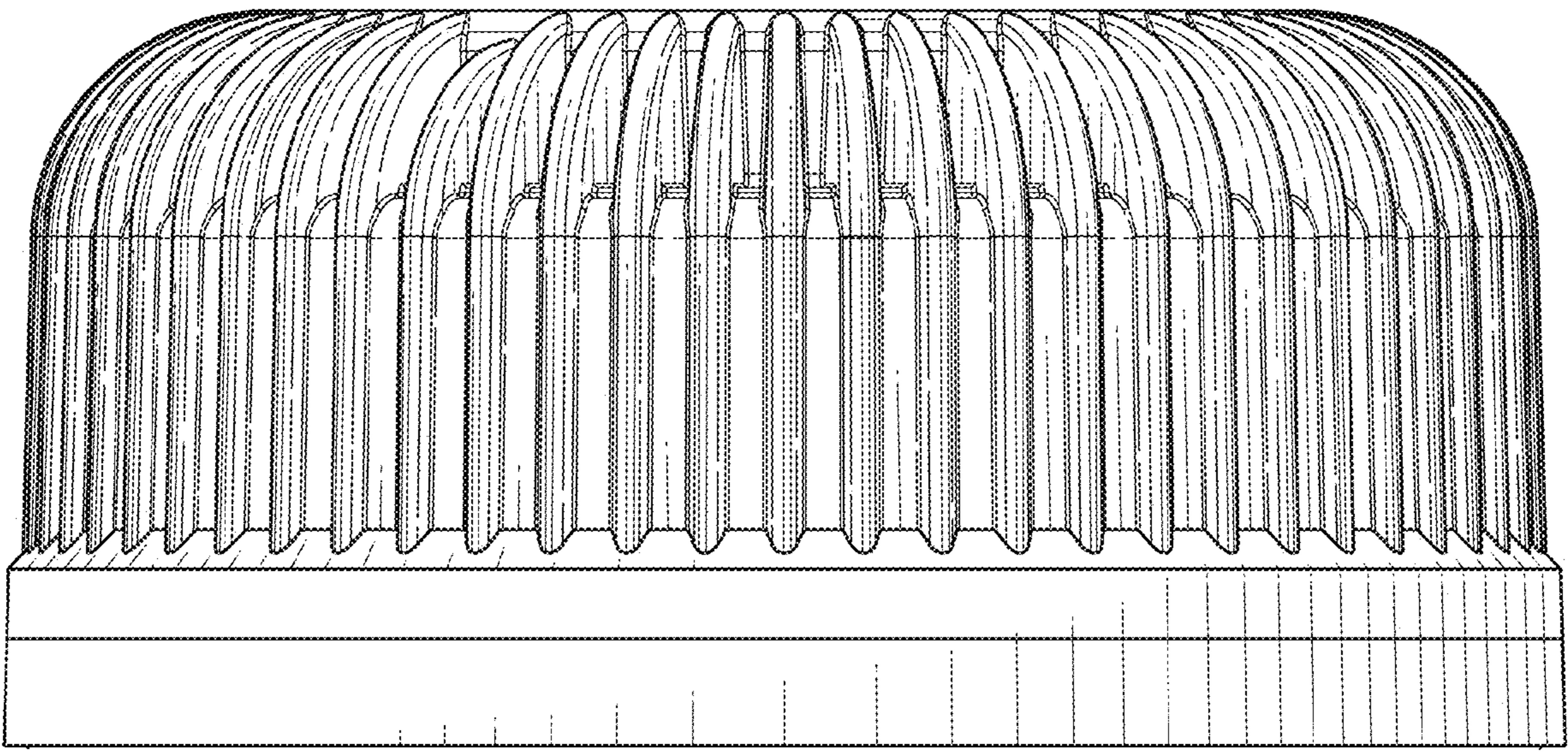

FIG. 4

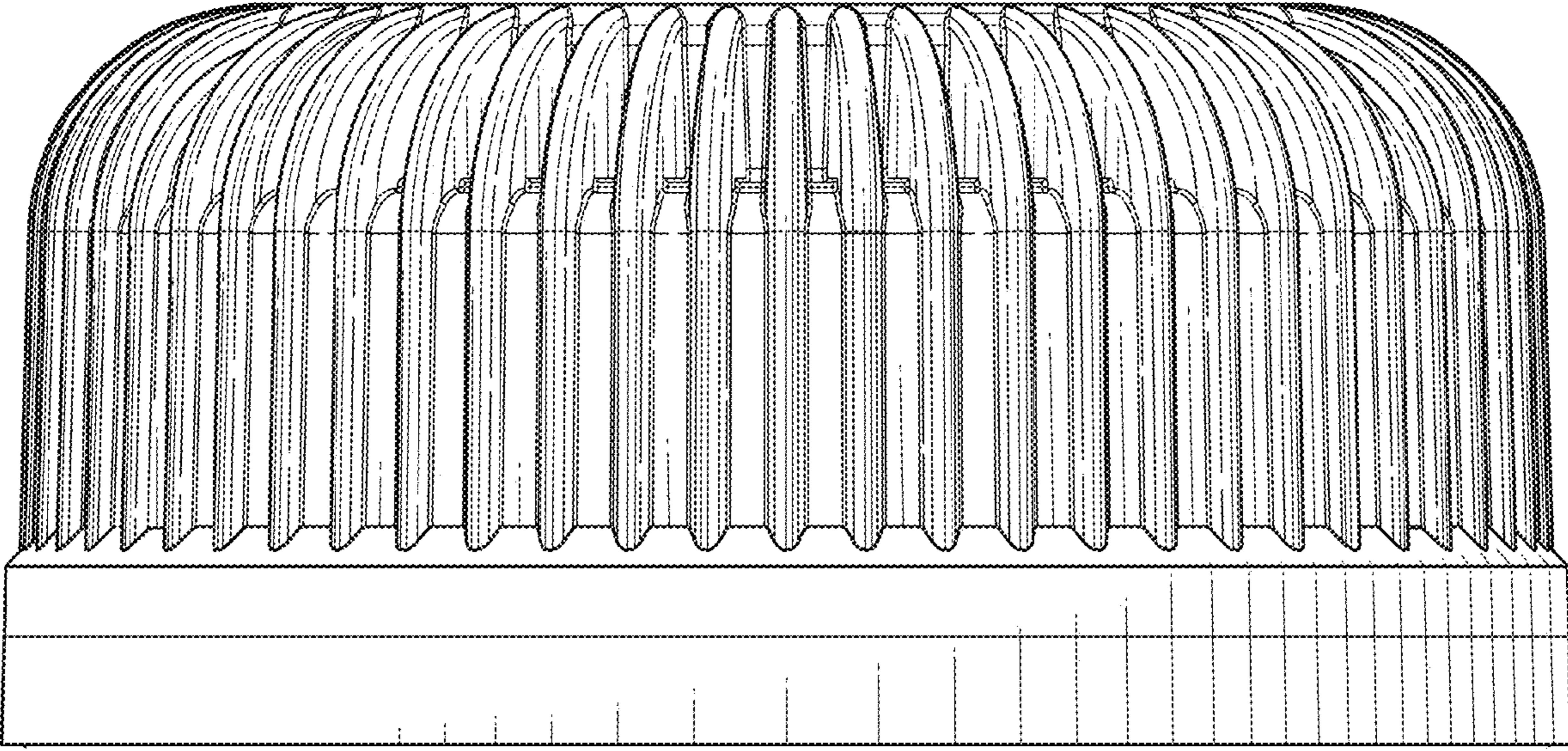

FIG. 5

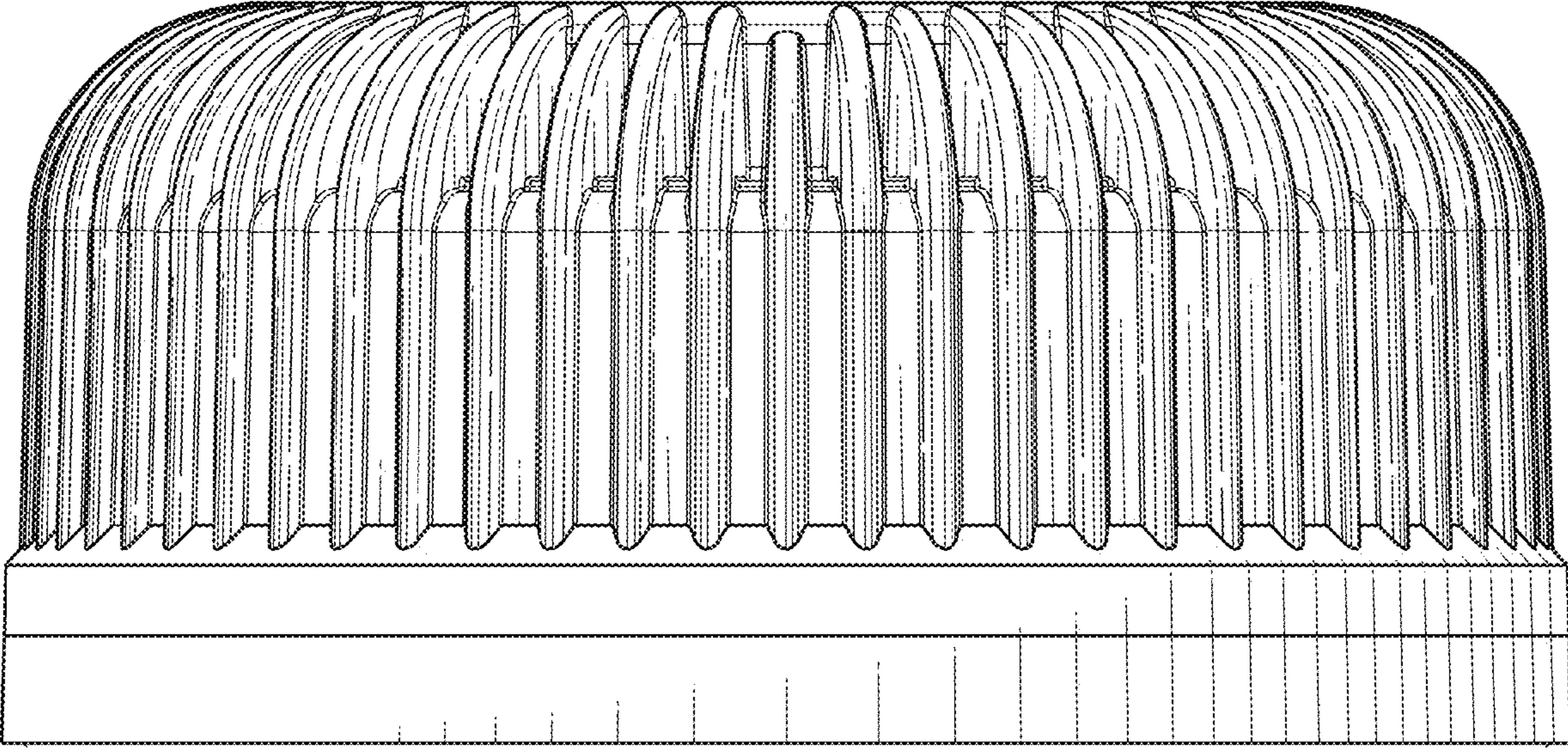

FIG. 6

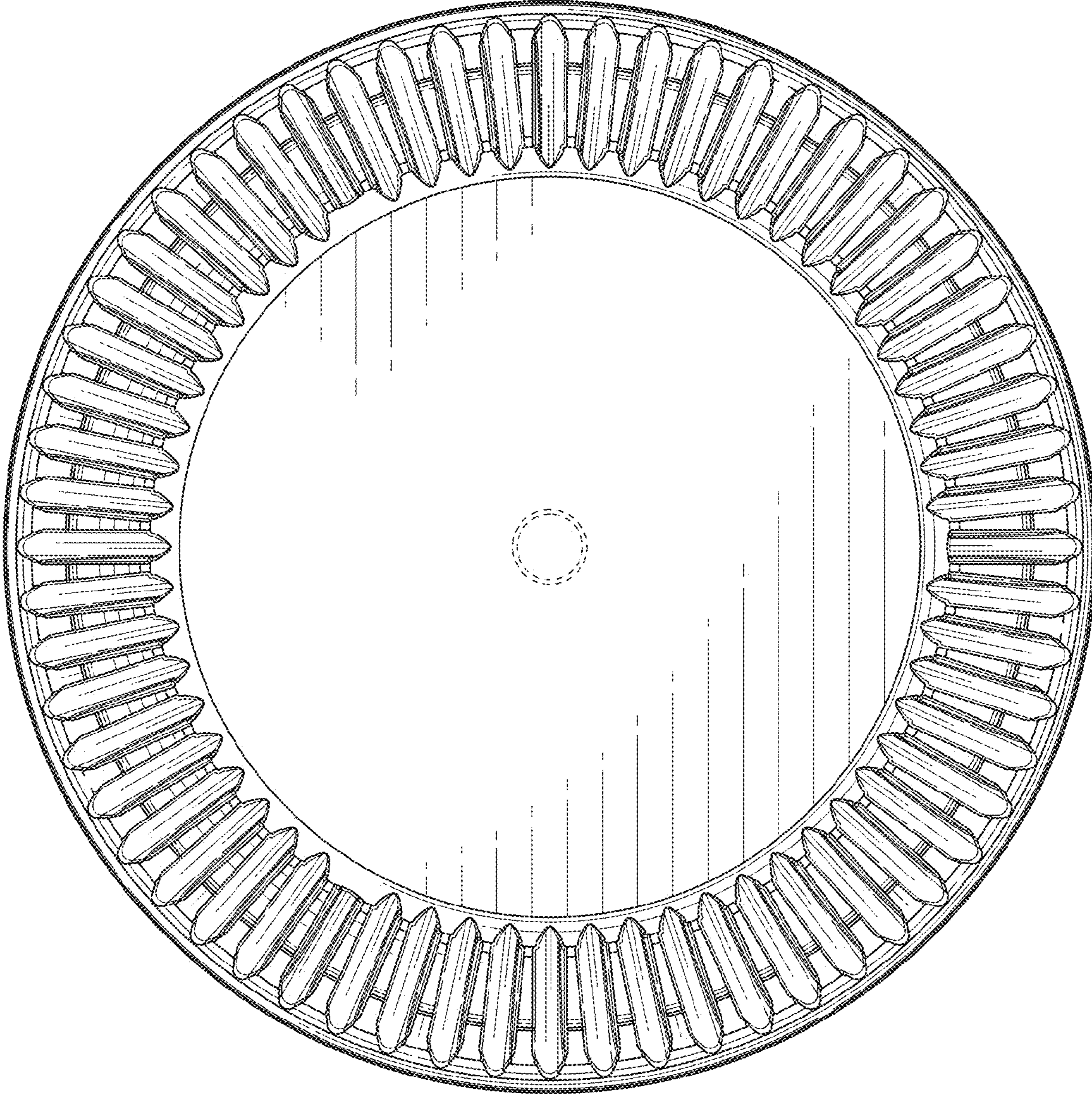

FIG. 7

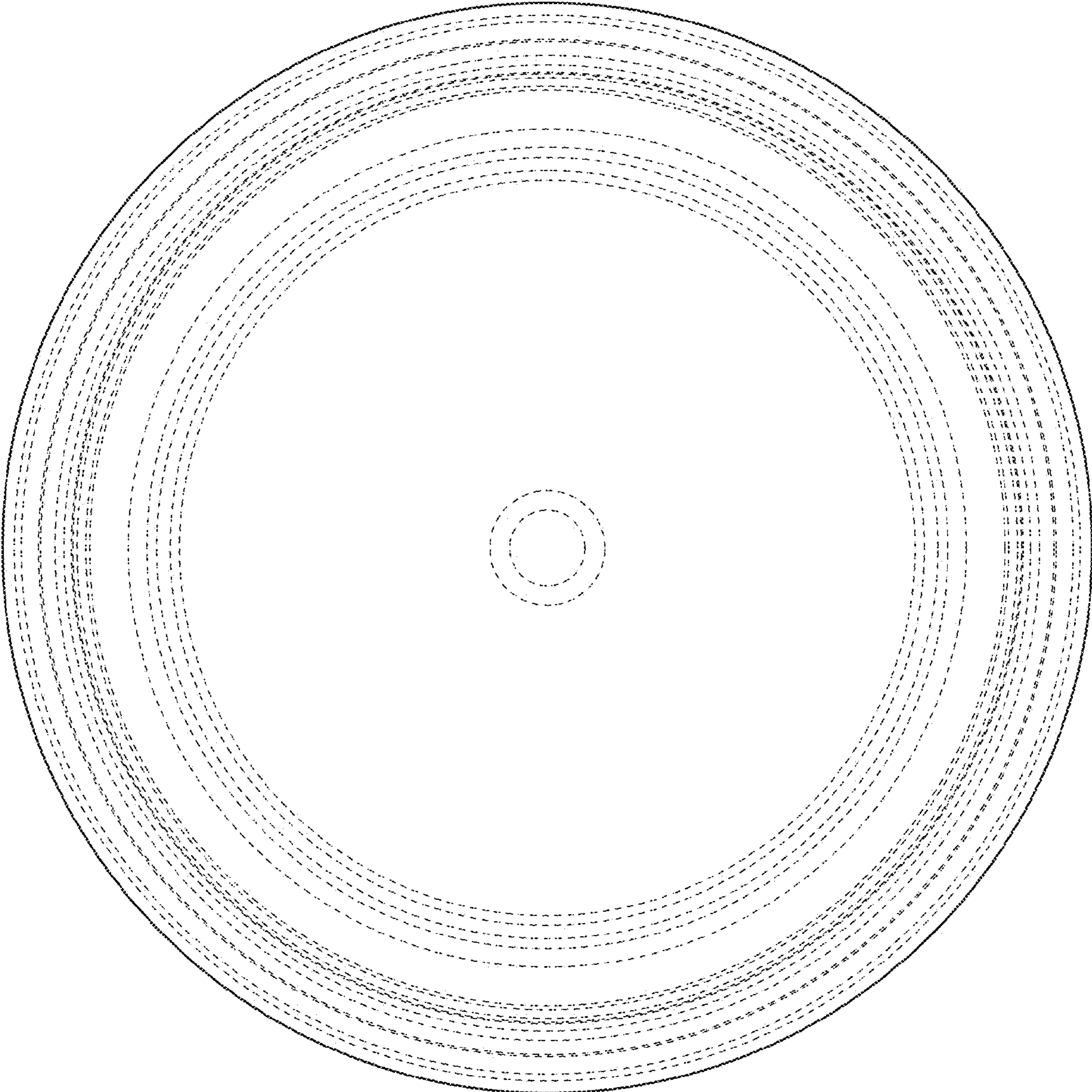

FIG. 8