



US00D885898S

(12) **United States Design Patent**
Edie et al.

(10) **Patent No.:** **US D885,898 S**

(45) **Date of Patent:** **** *Jun. 2, 2020**

(54) **CLOSURE**

(71) Applicant: **Closure Systems International Inc.**,
Memphis, TN (US)
(72) Inventors: **John Edie**, Crawfordsville, IN (US);
Jamison D. Woodley, Indianapolis, IN
(US); **Daniel H. Shulman**, Northbrook,
IL (US)

(73) Assignee: **Closure Systems International Inc.**,
Memphis, TN (US)

(*) Notice: This patent is subject to a terminal dis-
claimer.

(**) Term: **15 Years**

(21) Appl. No.: **29/632,112**

(22) Filed: **Jan. 5, 2018**

(51) **LOC (12) Cl.** **09-07**

(52) **U.S. Cl.**
USPC **D9/452**

(58) **Field of Classification Search**
USPC D7/387, 391, 392, 396.1, 396.2, 398,
D7/900; D9/438, 449, 452, 453, 454,
D9/414-435, 457, 499, 682, 685, 686,
D9/688, 723, 724, 763, 772; D12/197;
D24/121, 127, 224; D28/76, 78, 82;
D19/34.1, 162, 163, 164, 165, 192, 194
CPC B65D 51/18; B65D 51/28; B65D 51/242;
B65D 51/2814; B65D 51/2821; B65D
21/0228; B65D 41/3447; B65D 1/0246;
B65D 1/02; B65D 2251/0018; B65D
2251/0026; B65D 2251/009; B65D 55/02;
B65D 55/024; A47G 19/22; A47G
19/2205; A47G 19/2222; A47G 19/2266;
A47G 19/2272; A47G 19/2294; A47J
43/27; A47J 36/06; A47J 36/10; A47J
36/14

See application file for complete search history.

(56) **References Cited**

U.S. PATENT DOCUMENTS

5,487,481 A * 1/1996 Sander B65D 41/3447
215/252
5,725,116 A * 3/1998 Takai B65D 41/3409
215/252
D407,978 S * 4/1999 Petro D9/453
(Continued)

FOREIGN PATENT DOCUMENTS

EM 001858002 S 5/2011
WO 2014060893 A1 4/2014
WO 2017139902 A2 8/2017

OTHER PUBLICATIONS

Aqua Lok Mini: Site Visited Dec. 27, 2018. Available from Internet
URL: http://csiclosures.com/markets-served/beverages/bottled-water/aqua-lok-mini-26mm-tc?s=capfinder.*

(Continued)

Primary Examiner — Catherine S Posthauer

(74) *Attorney, Agent, or Firm* — Nixon Peabody LLP

(57) **CLAIM**

The ornamental design for a closure, as shown and
described.

DESCRIPTION

FIG. 1 is a top perspective view of a closure, showing our
new design.

FIG. 2 is a bottom perspective view of the closure of FIG.
1.

FIG. 3 is a left side view of the closure of FIG. 1.

FIG. 4 is a right side view of the closure of FIG. 1.

FIG. 5 is a front view of the closure of FIG. 1.

FIG. 6 is a back view of the closure of FIG. 1.

FIG. 7 is a top view of the closure of FIG. 1; and,

FIG. 8 is a bottom view of the closure of FIG. 1.

(Continued)

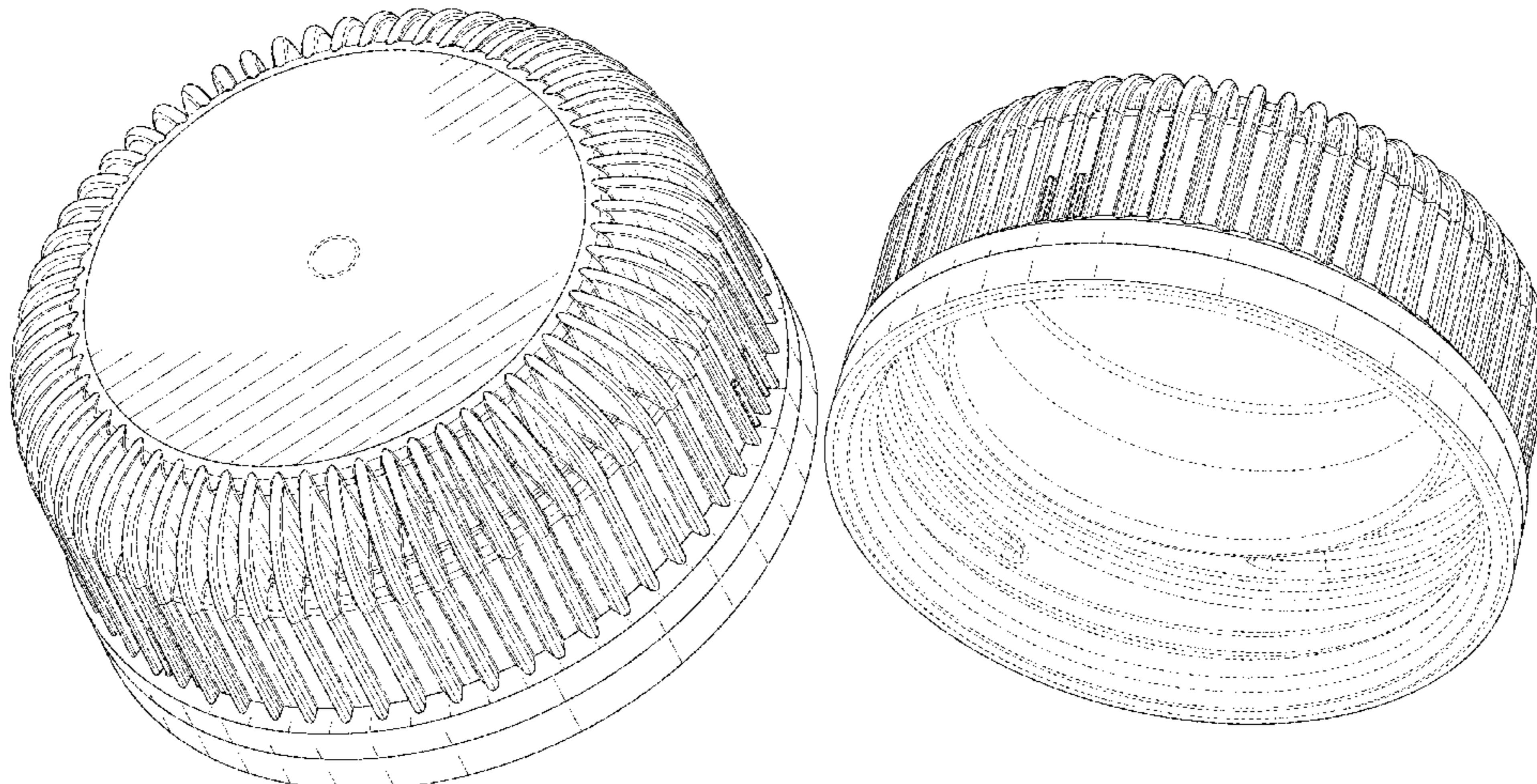

The broken lines are shown for the purpose of illustrating parts of the article that form no part of the claim.

1 Claim, 6 Drawing Sheets

(56)

References Cited

U.S. PATENT DOCUMENTS

D437,218 S * 2/2001 Ljunstrom D9/417
 6,308,848 B1 * 10/2001 Parrinello B65D 41/3428
 215/252
 D458,138 S * 6/2002 Fuchs D9/453
 6,405,886 B1 * 6/2002 Gearhart B65D 41/3428
 215/252
 D460,357 S * 7/2002 Kras D9/435
 D465,731 S * 11/2002 Brant D9/453
 D518,717 S * 4/2006 German D9/453
 D574,240 S * 8/2008 Szczesniak D9/453
 D584,149 S * 1/2009 Lohrman D9/453
 D606,864 S * 12/2009 Robinson D9/453
 D619,003 S * 7/2010 Benoit-Gonin D9/453
 D632,958 S * 2/2011 Fuchs D9/453
 D634,200 S * 3/2011 Taber D9/453
 D671,834 S * 12/2012 Chasteen D9/453
 D687,299 S 8/2013 Peykoff et al.
 D693,221 S * 11/2013 Ramsey D9/453
 D693,685 S * 11/2013 Ramsey D9/453
 D723,919 S * 3/2015 Taber D9/438
 9,181,001 B2 * 11/2015 Molinaro B65D 1/023
 D762,115 S 7/2016 Corvaglia et al.
 D789,201 S * 6/2017 Yu D9/453

D790,966 S * 7/2017 Roberts D9/453
 D824,257 S 7/2018 Wood
 D836,442 S * 12/2018 Wood D9/453
 D838,171 S 1/2019 Wood
 2009/0014404 A1 * 1/2009 Russell B65D 50/041
 215/220
 2011/0290754 A1 * 12/2011 Taber B65D 41/04
 215/329
 2011/0290755 A1 * 12/2011 Taber B65D 41/00
 215/329
 2012/0031871 A1 * 2/2012 Molinaro B65D 1/023
 215/44
 2013/0313218 A1 * 11/2013 Cox B65D 41/0485
 215/246
 2015/0122769 A1 * 5/2015 Taber B65D 51/145
 215/350
 2016/0288961 A1 * 10/2016 Maguire B65D 55/16
 2017/0166360 A1 * 6/2017 Falzoni B65D 41/0421
 2018/0079570 A1 * 3/2018 Maguire B65D 55/16
 2018/0257822 A1 * 9/2018 Neputy B65D 41/0485
 2018/0370701 A1 * 12/2018 Maguire B29C 45/0017

OTHER PUBLICATIONS

Betapack Pedrosa Cap: Site Visited Dec. 27, 2018. Available from Internet URL: <https://www.betapack.com/en/site/caps/11/pedrosa>.
 Betapack Cap: Site Visited Dec. 27, 2018. Available from Internet URL: <https://www.betapack.com/en/site/caps/35/30-25-a>.
 Tamper Evident Cap: Announced Sep. 10, 2017 [online]. Site Visited Dec. 27, 2018. Available from Internet URL: <https://catalog.berryglobal.com/products/closure/closure-tamper-evident/closure778ce2626pfg3>.

* cited by examiner

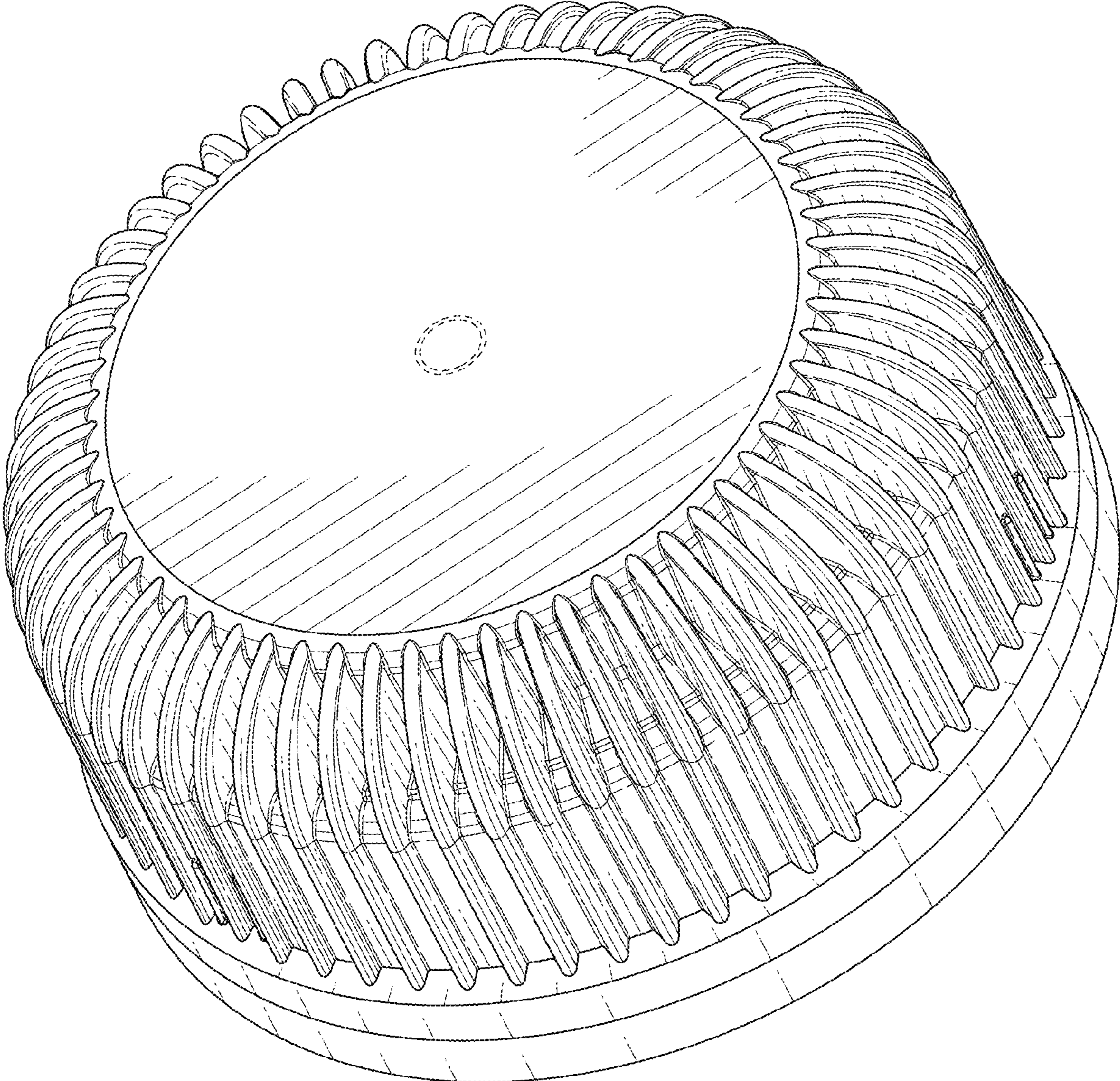

FIG. 1

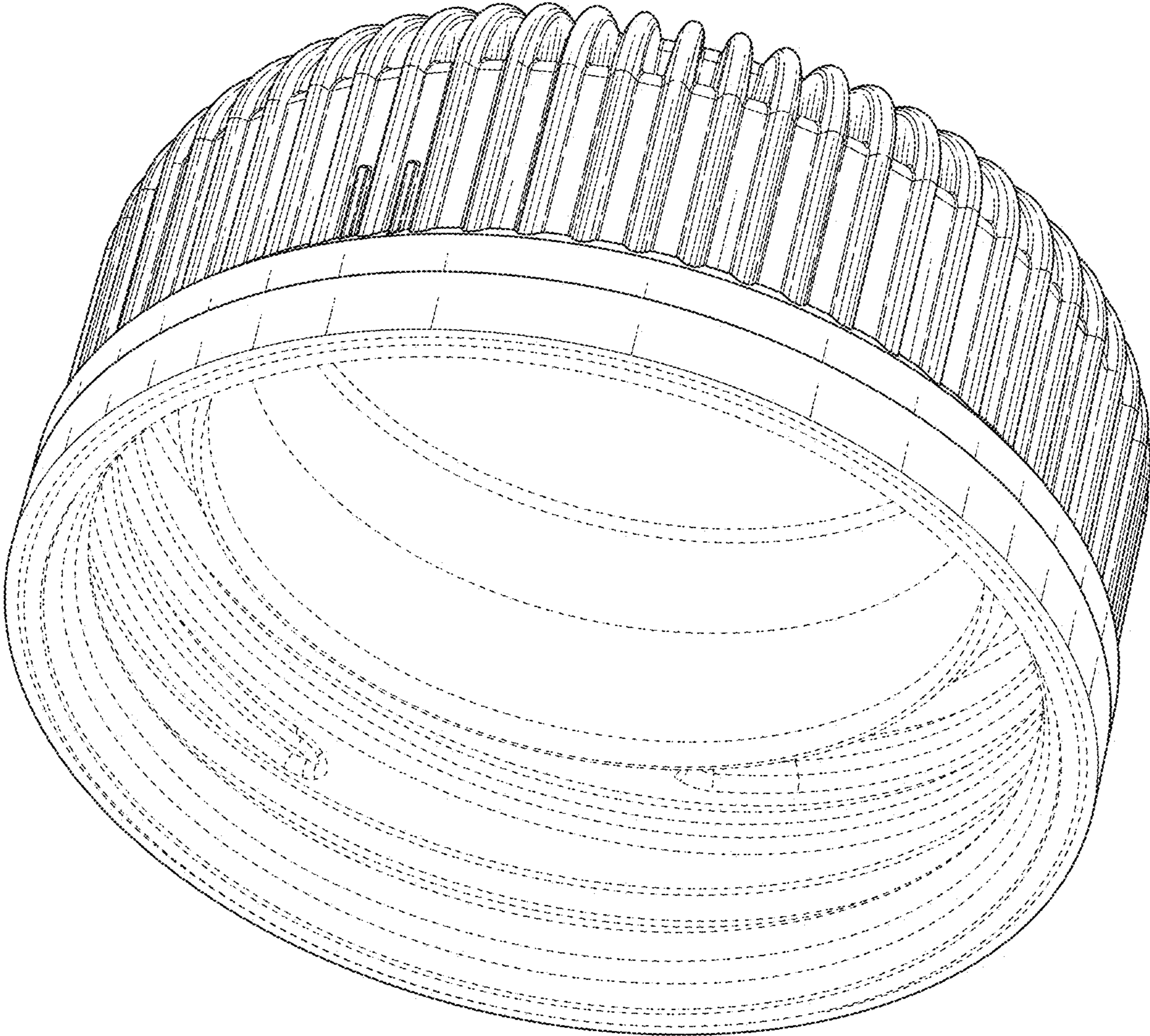

FIG. 2

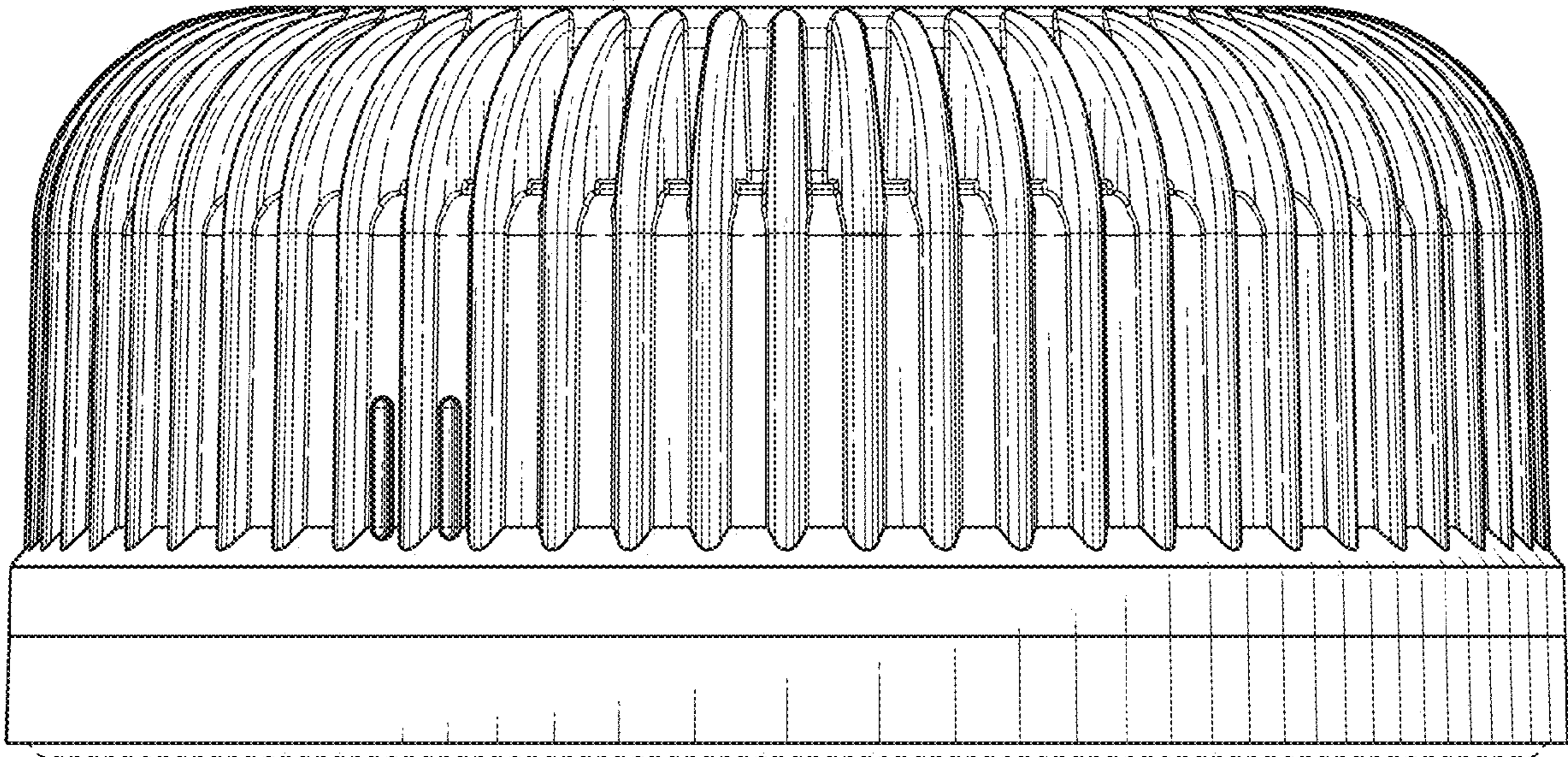

FIG. 3

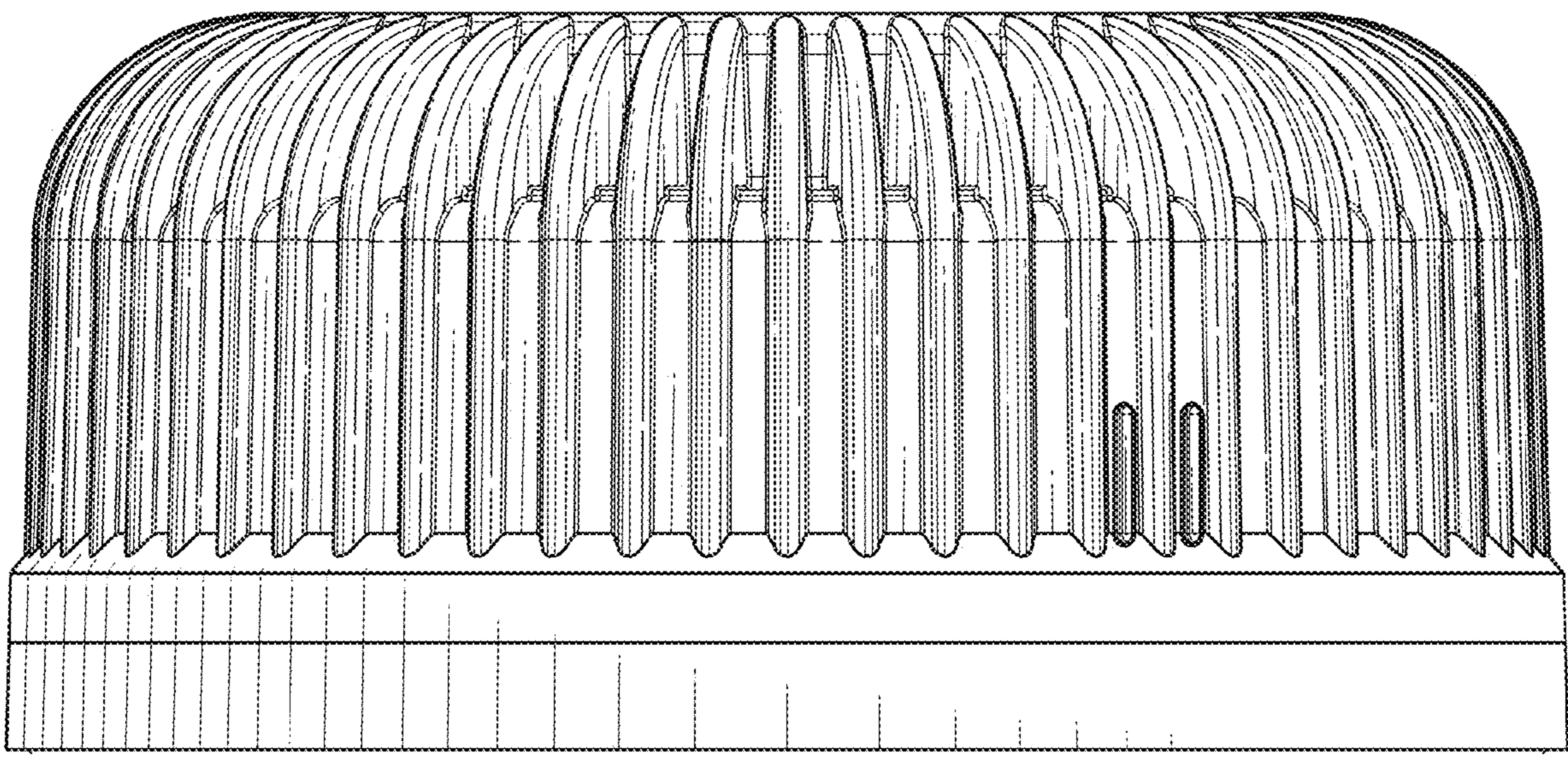

FIG. 4

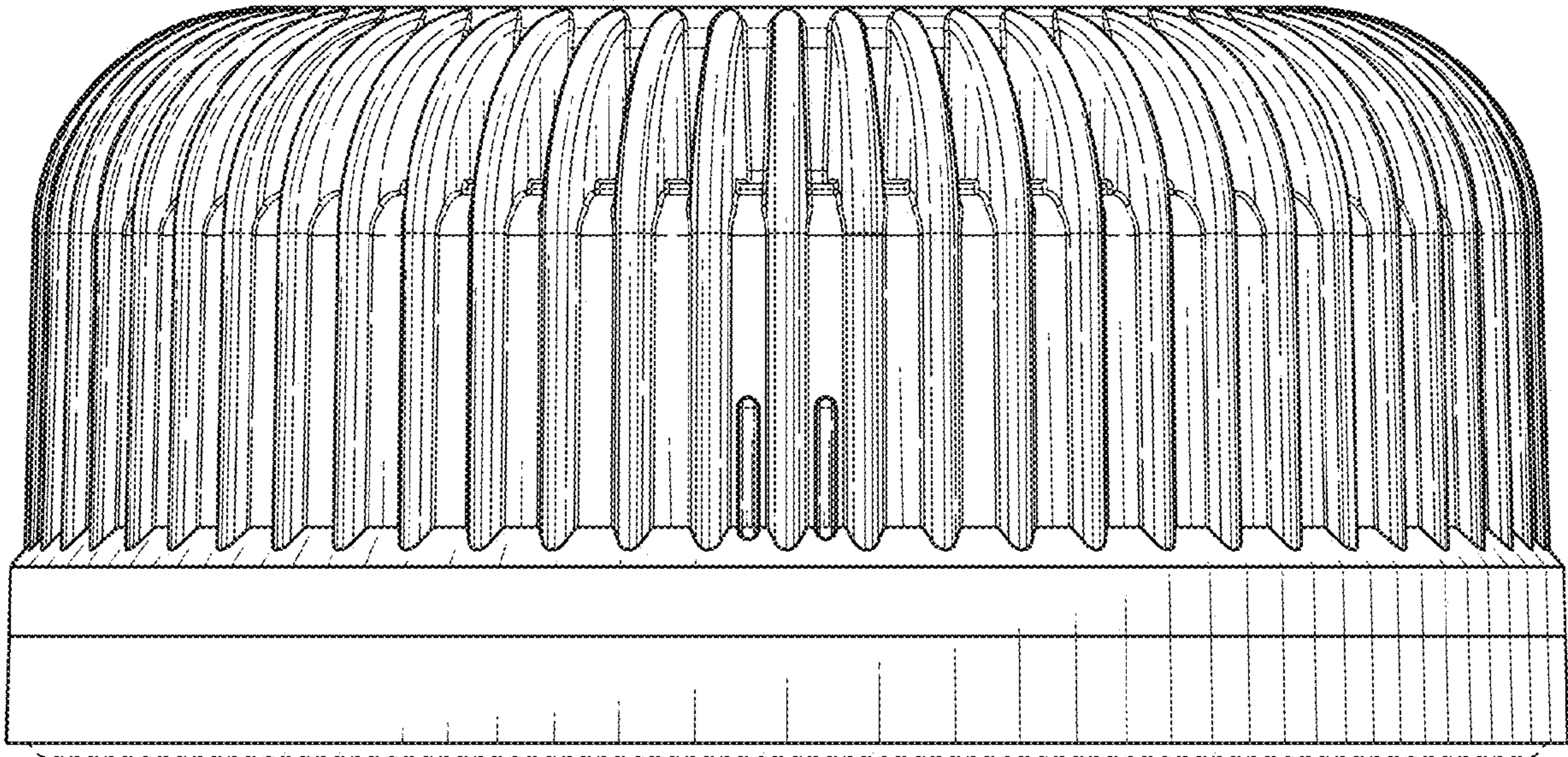

FIG. 5

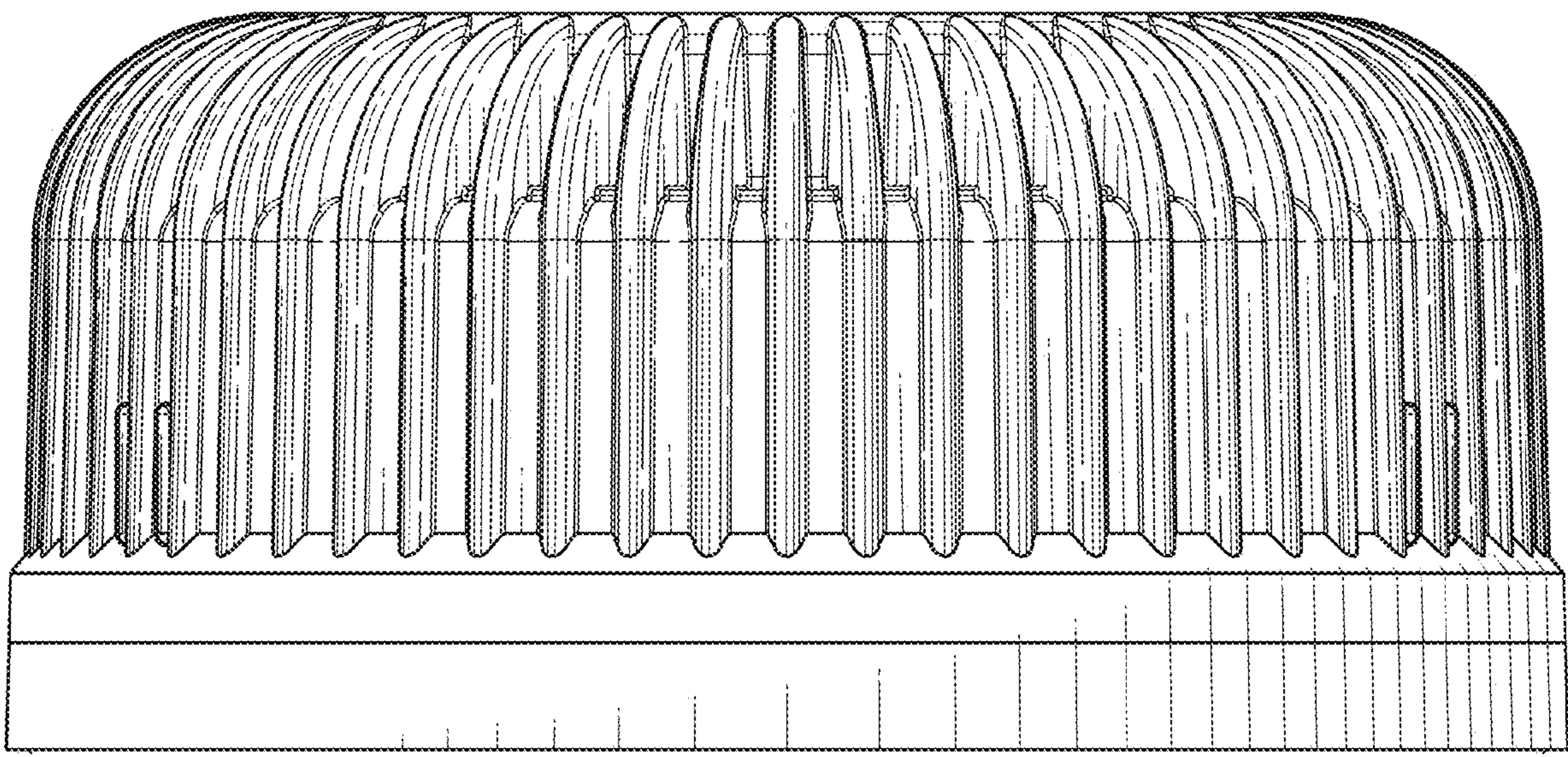

FIG. 6

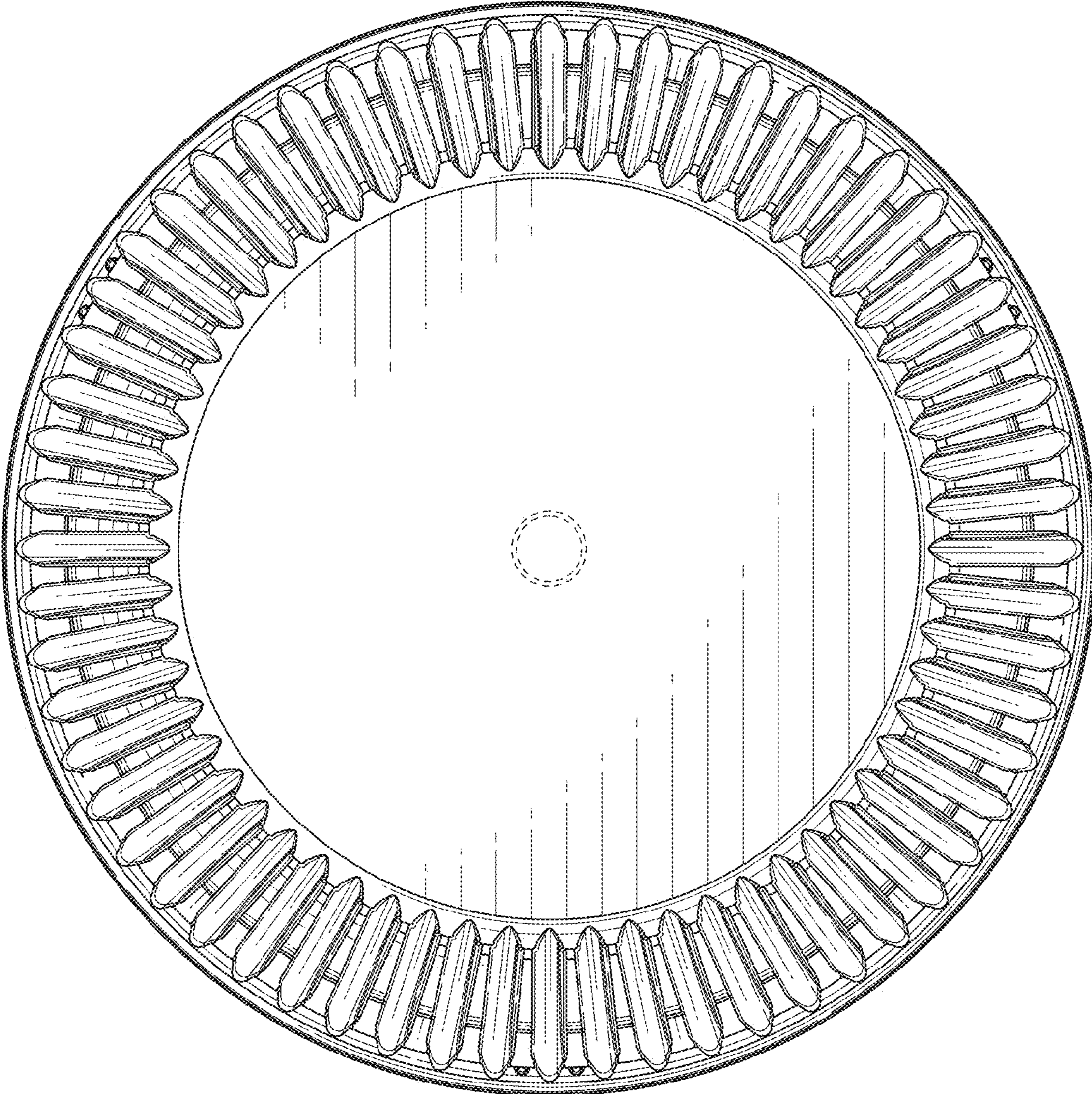

FIG. 7

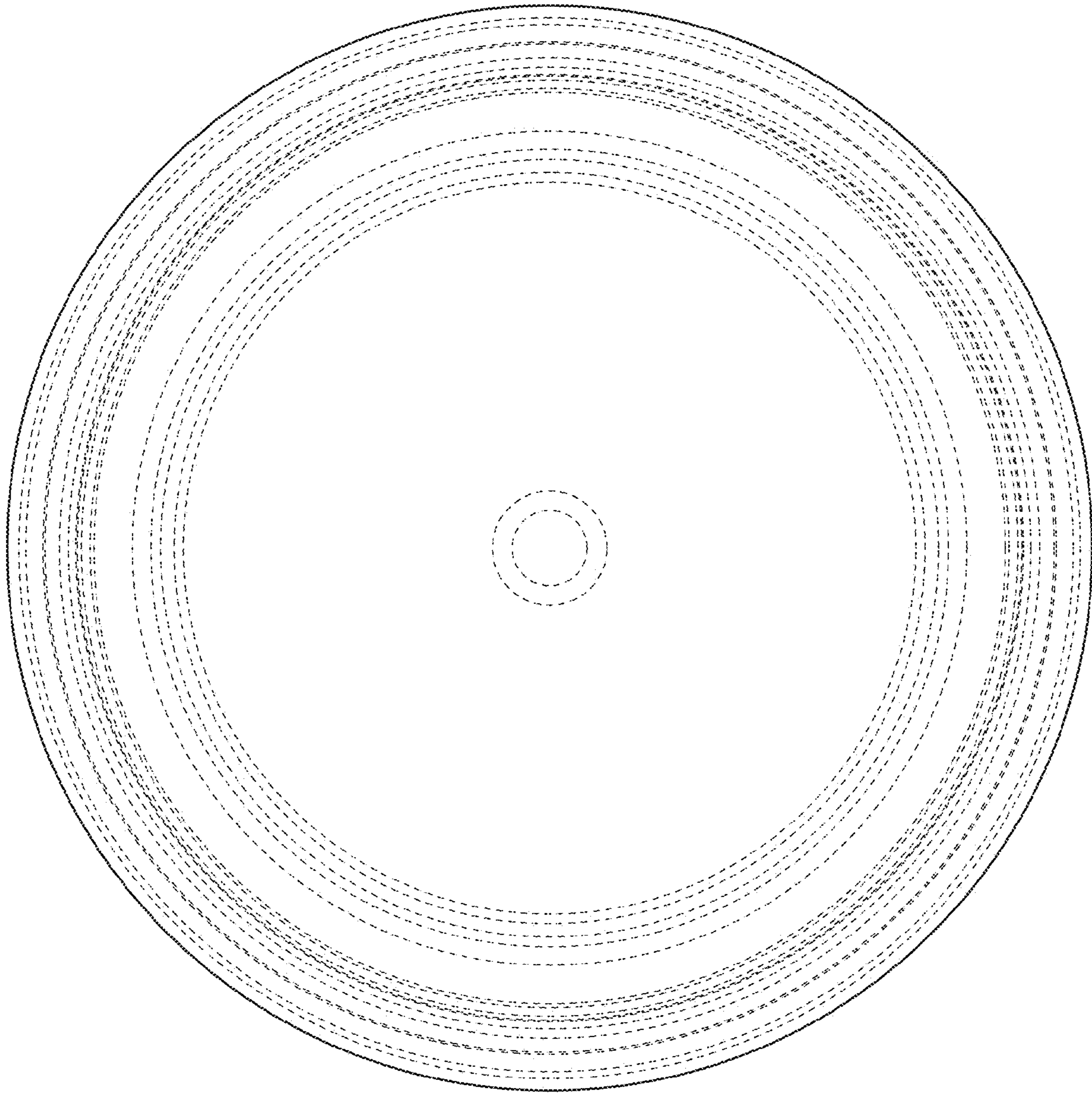

FIG. 8