



US00D885884S

(12) **United States Design Patent**
Dietvorst et al.

(10) **Patent No.: US D885,884 S**

(45) **Date of Patent: ** *Jun. 2, 2020**

(54) **BOX**

(71) Applicant: **Reckitt Benckiser Health Limited**,
Slough (GB)

(72) Inventors: **Taco Dietvorst**, Eindhoven (NL); **Rens
Jurian Hoeke**, Eindhoven (NL); **Teun
Franciscus Van Wetten**, Eindhoven
(NL)

(73) Assignee: **RECKITT BENCKISER HEALTH
LIMITED**, Slough (GB)

(*) Notice: This patent is subject to a terminal dis-
claimer.

(**) Term: **15 Years**

(21) Appl. No.: **29/669,266**

(22) Filed: **Nov. 7, 2018**

(30) **Foreign Application Priority Data**

May 10, 2018 (EM) 005264504-0001
May 10, 2018 (EM) 005264504-0003

(51) **LOC (12) Cl.** **09-03**

(52) **U.S. Cl.**
USPC **D9/423**; D9/432

(58) **Field of Classification Search**
USPC D9/414-423, 430-433, 434, 456, 457,
D9/711, 713, 721-722; D20/10, 22, 27,
D20/40, 42
CPC ... B65D 5/00; B65D 5/02; B65D 5/18; B65D
5/20
See application file for complete search history.

(56) **References Cited**

U.S. PATENT DOCUMENTS

1,800,550 A * 4/1931 Mahoney, Jr. B65D 5/52
206/45.29
3,927,761 A * 12/1975 Boyle B65D 5/18
206/756

D251,360 S * 3/1979 Collin D9/432
4,553,666 A * 11/1985 Gullikson B65D 5/5445
229/112
7,066,321 B2 * 6/2006 Kawaguchi B65D 5/0227
206/499
7,097,038 B2 * 8/2006 Kinigakis B65D 5/548
206/541
D548,592 S * 8/2007 Kudo D9/432

(Continued)

OTHER PUBLICATIONS

KY Condoms Path. [online] Retrieved Nov. 1, 2019 from URL:
<https://wearepath.com/portfolio/ky-condoms/>.*

Primary Examiner — Vy N Koenig

(74) *Attorney, Agent, or Firm* — Troutman Sanders LLP;
Ryan A. Schneider; Chris Davis

(57) **CLAIM**

The ornamental design for a box, as shown and described.

DESCRIPTION

FIG. 1 is a perspective view of our new design for a box shown in an open configuration;
FIG. 2 is a front elevation view thereof;
FIG. 3 is a left side elevation view thereof;
FIG. 4 is a rear elevation view thereof;
FIG. 5 is a right side elevation view thereof;
FIG. 6 is a top plan view thereof;
FIG. 7 is a bottom plan view thereof;
FIG. 8 is a perspective view of the box of FIG. 1 shown in an alternate closed configuration.
FIG. 9 is a front elevation view thereof;
FIG. 10 is a left side elevation view thereof;
FIG. 11 is a rear elevation view thereof;
FIG. 12 is a right side elevation view thereof;
FIG. 13 is a top plan view thereof; and,
FIG. 14 is a bottom plan view thereof.

1 Claim, 14 Drawing Sheets

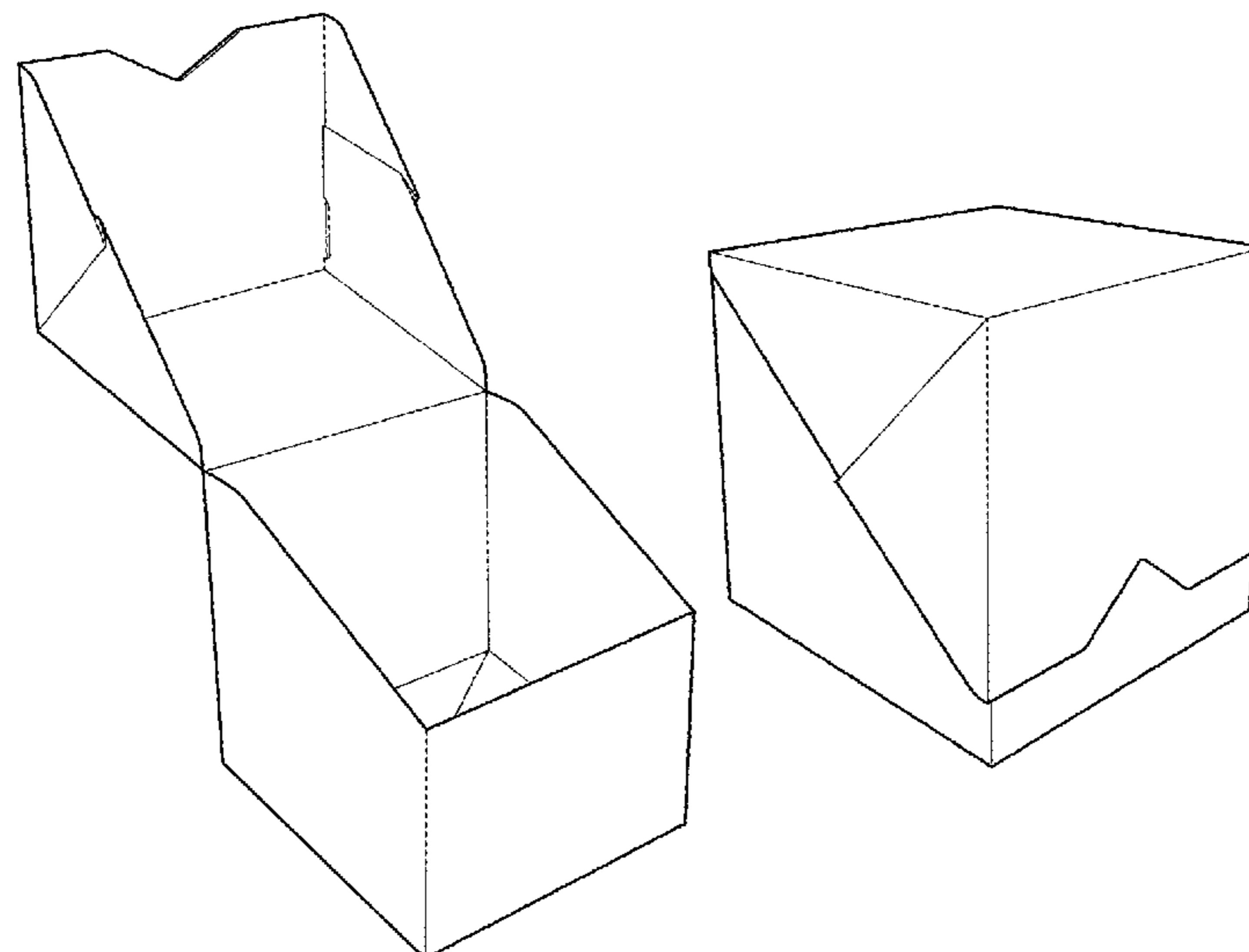

(56)

References Cited

U.S. PATENT DOCUMENTS

8,342,335 B2 * 1/2013 Couture B65D 5/5445
206/746
8,910,856 B2 * 12/2014 Sumpmann B65B 69/0033
206/746
2011/0284621 A1 * 11/2011 Couture B65D 5/5445
229/103

* cited by examiner

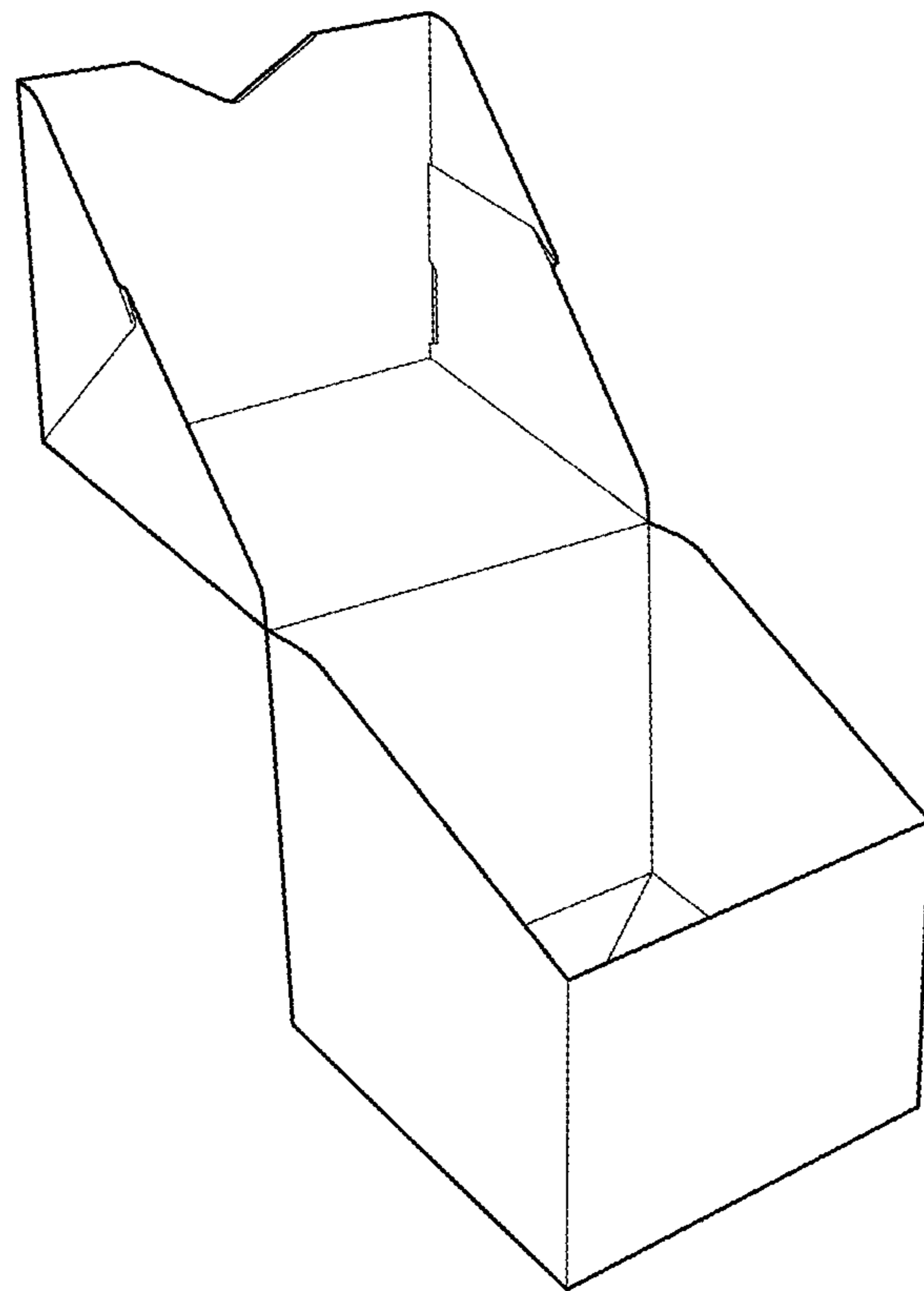

Fig. 1

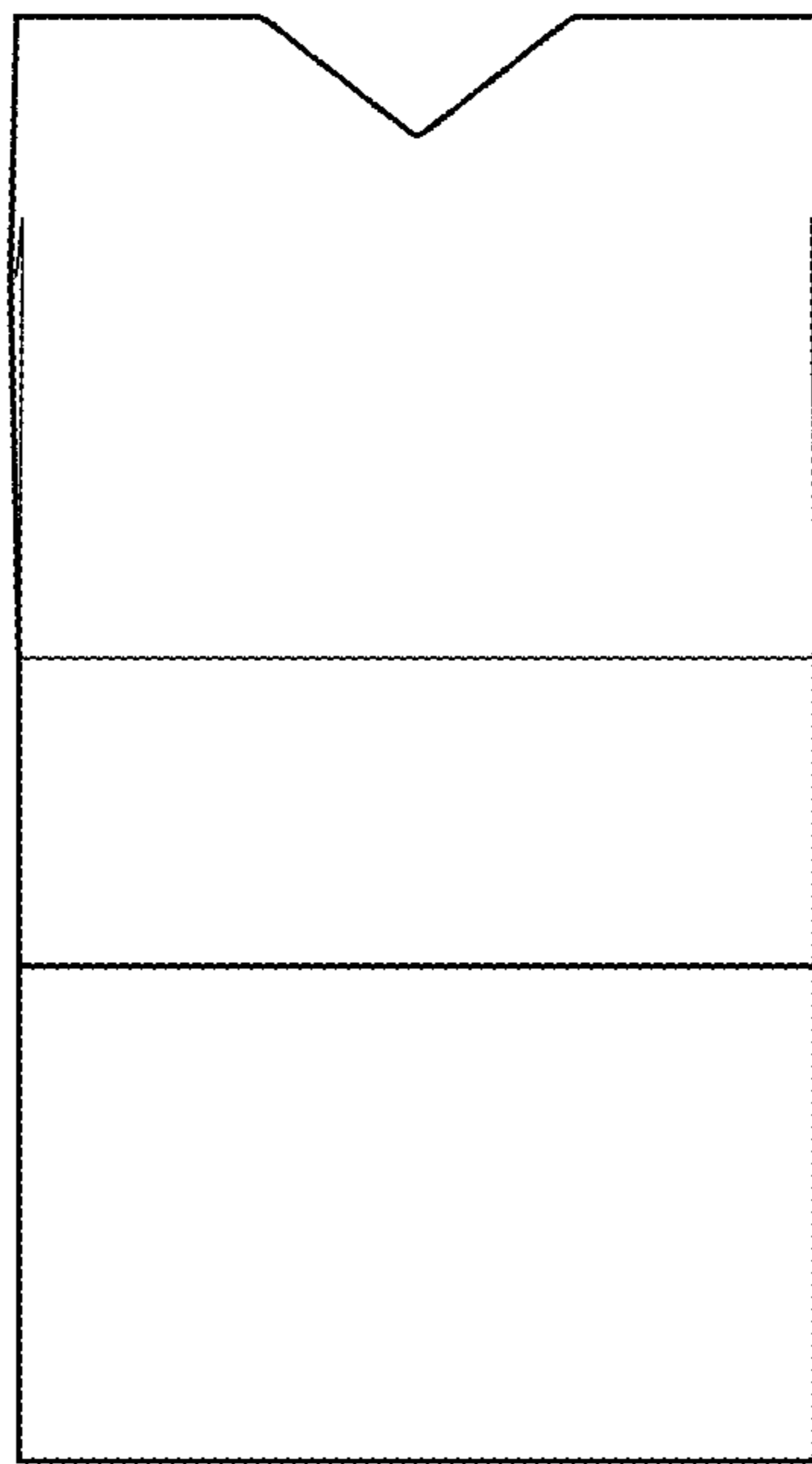

Fig. 2

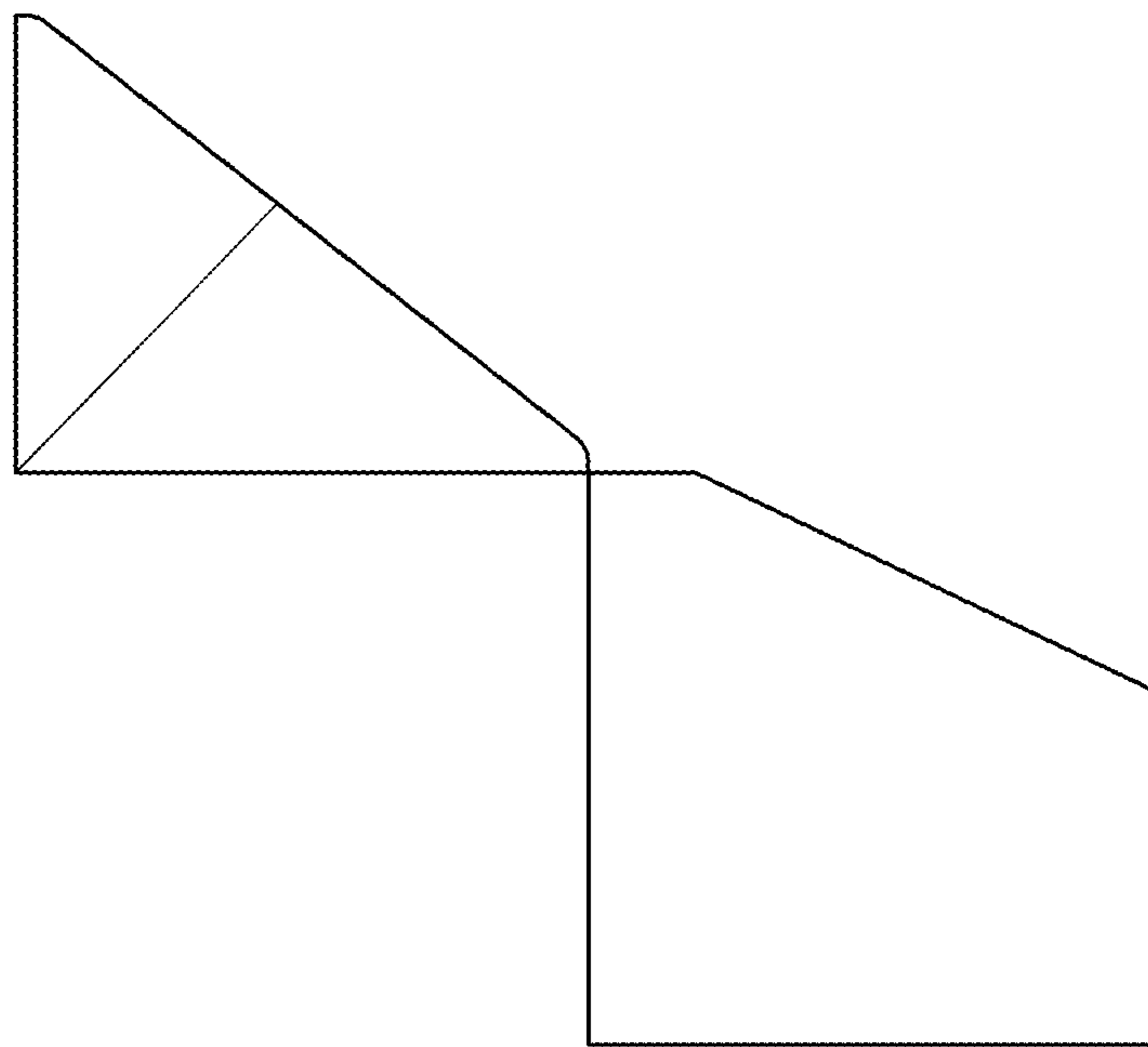

Fig. 3

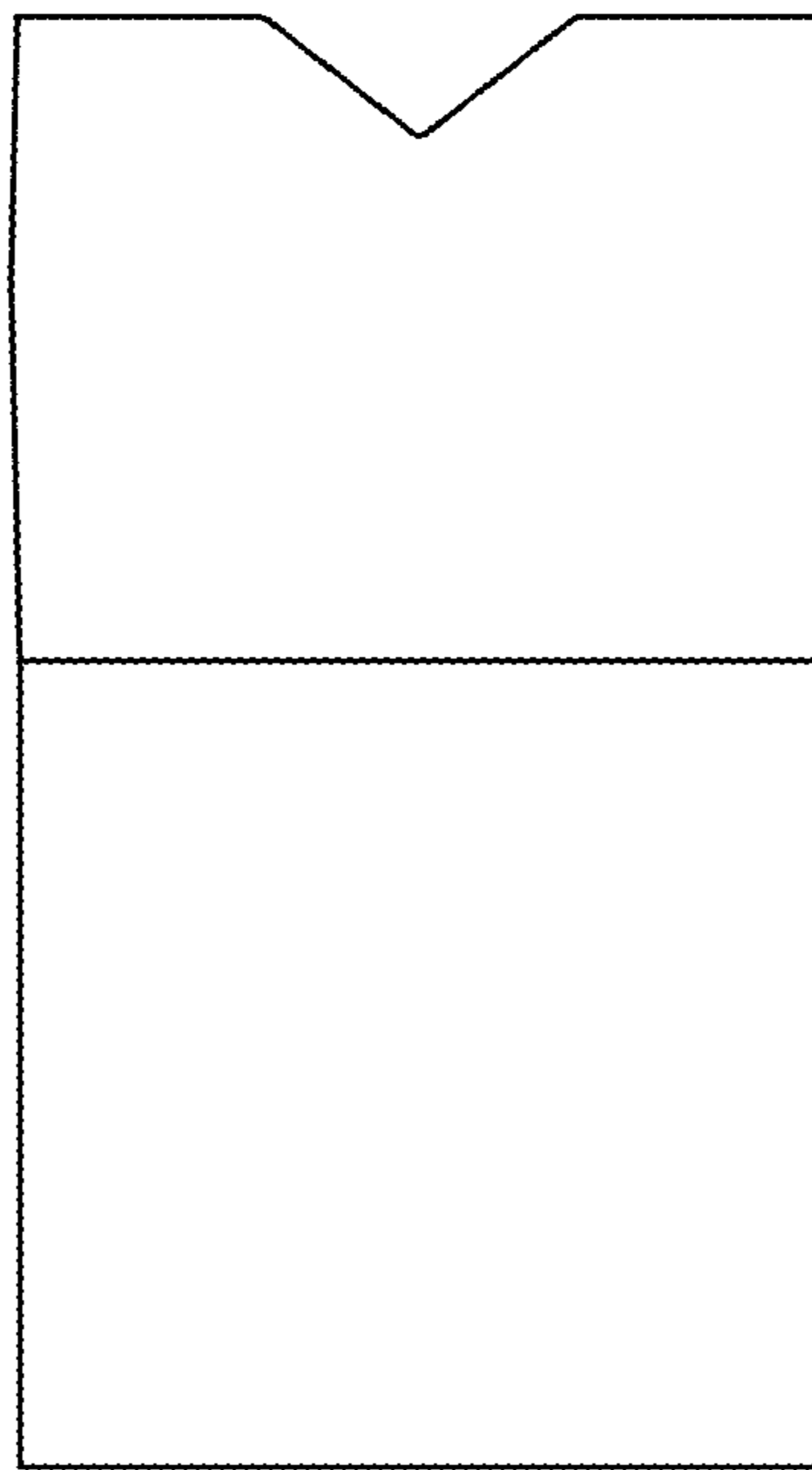

Fig. 4

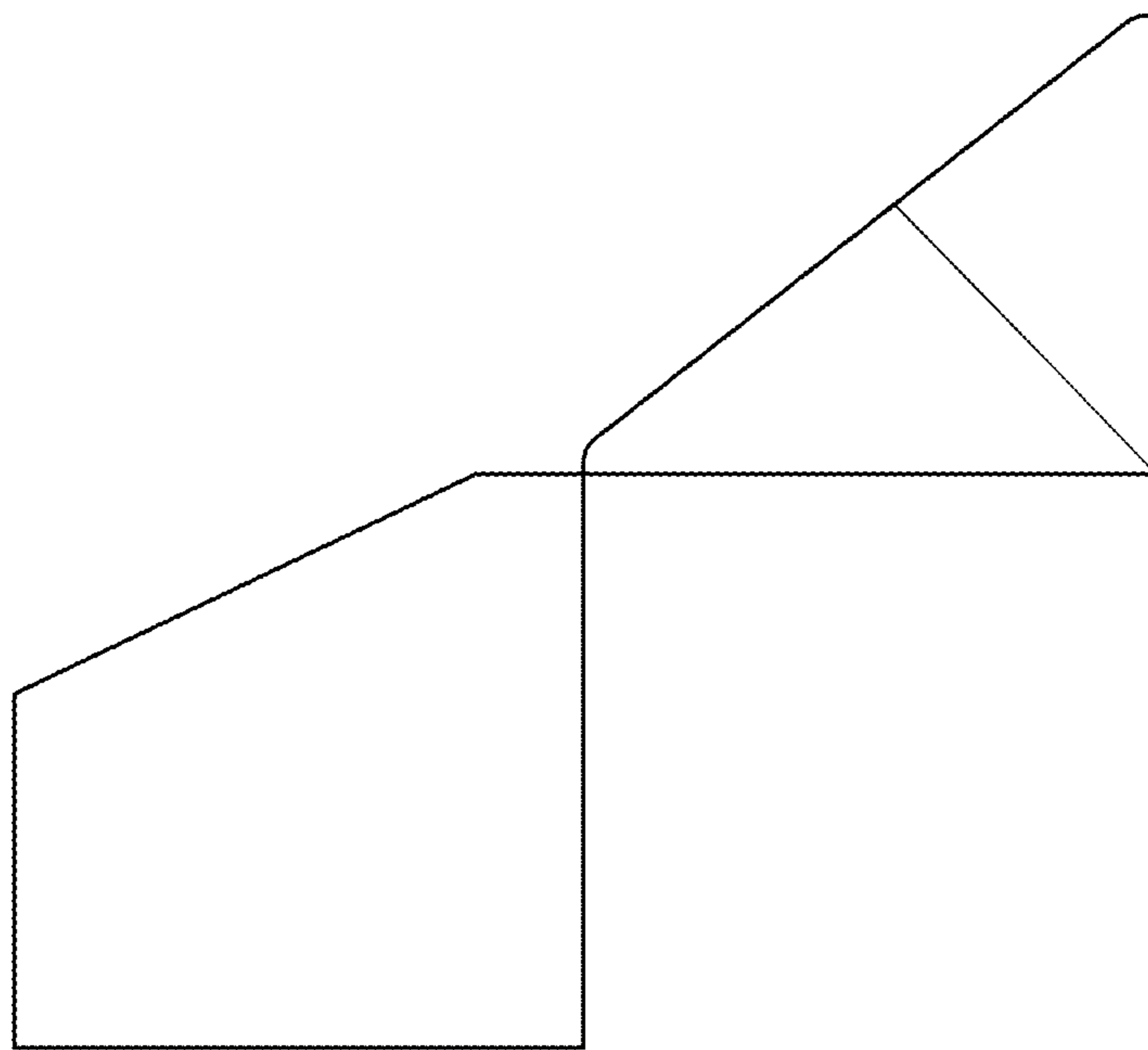

Fig. 5

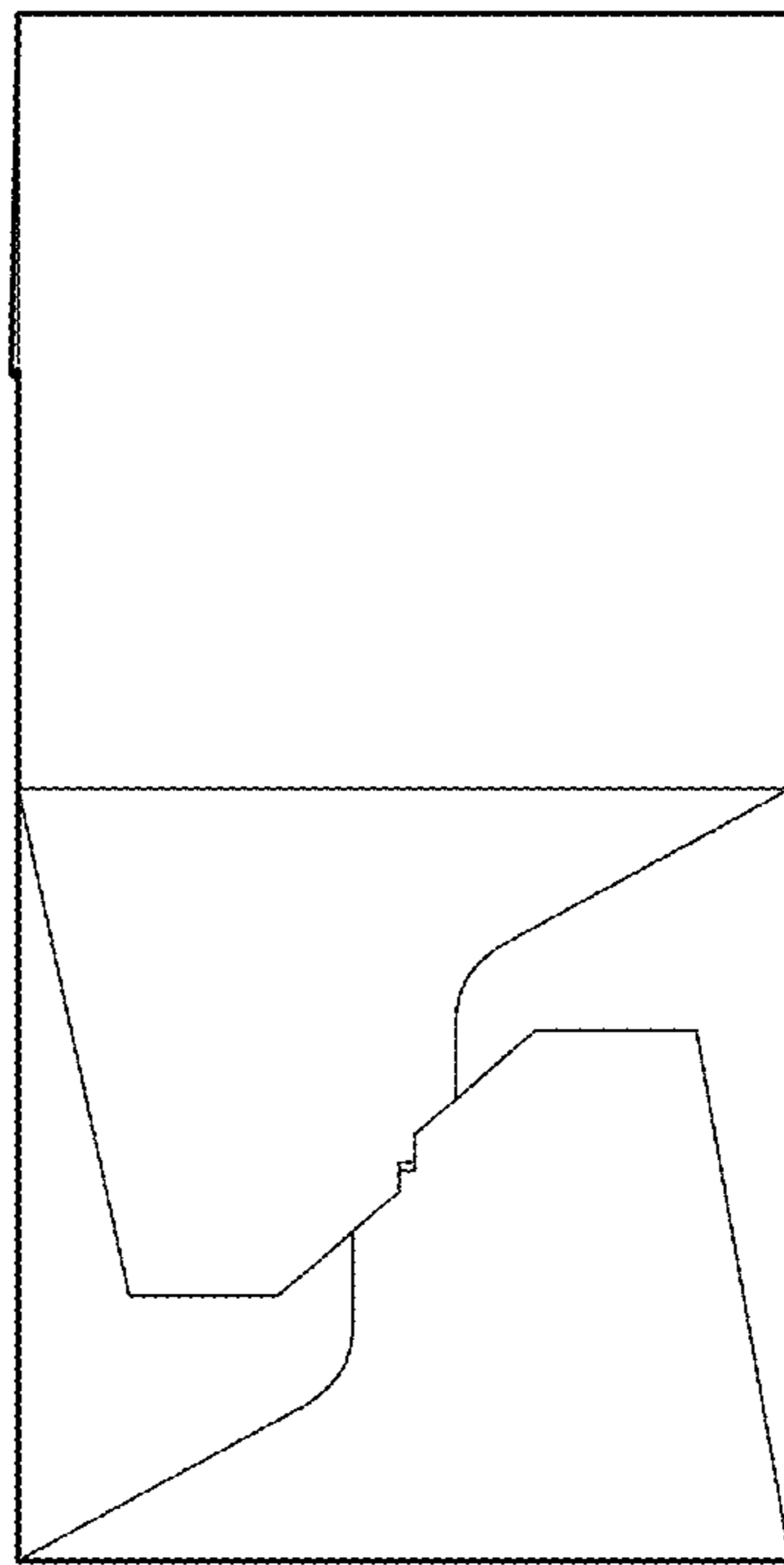

Fig. 6

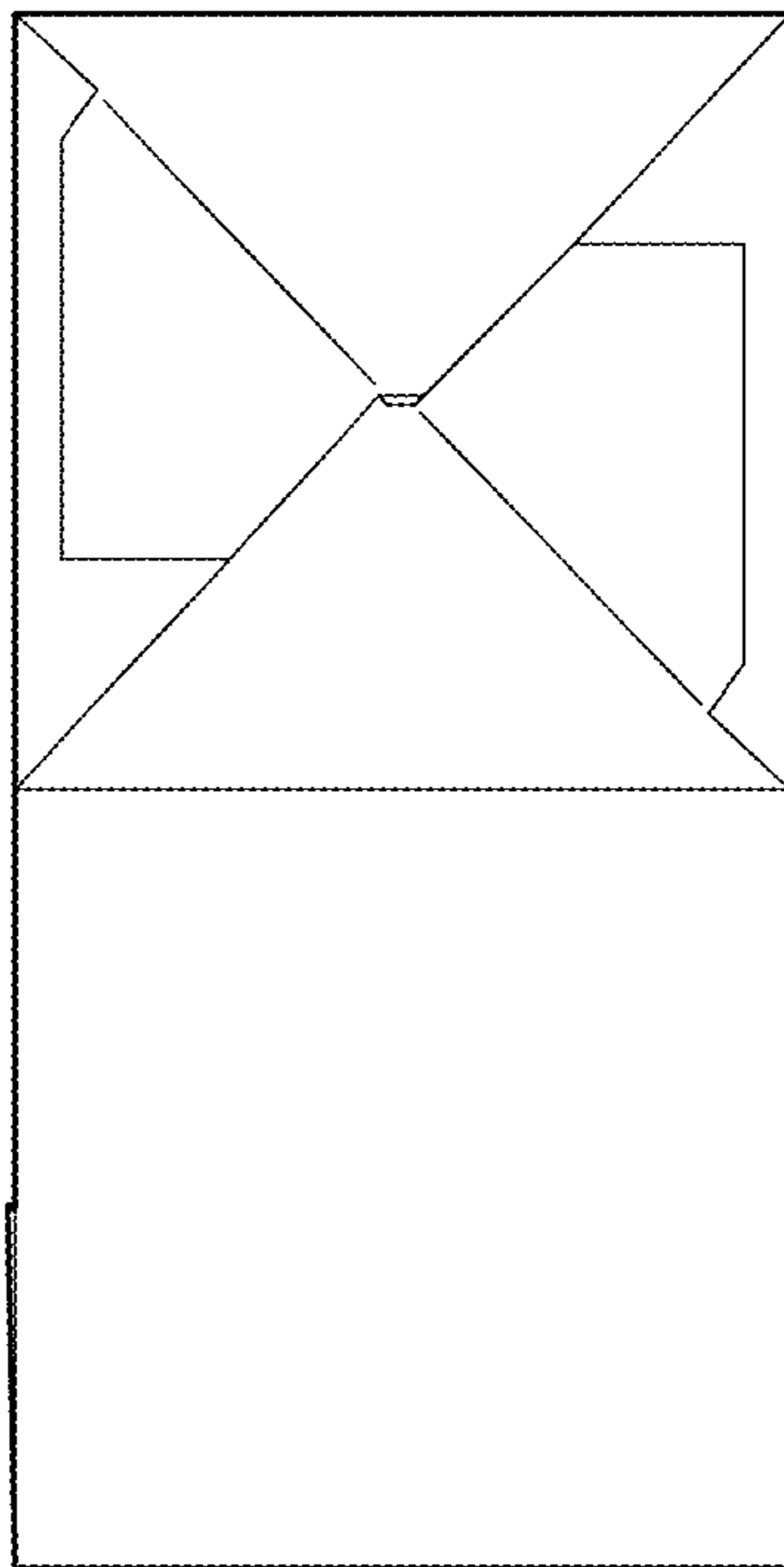

Fig. 7

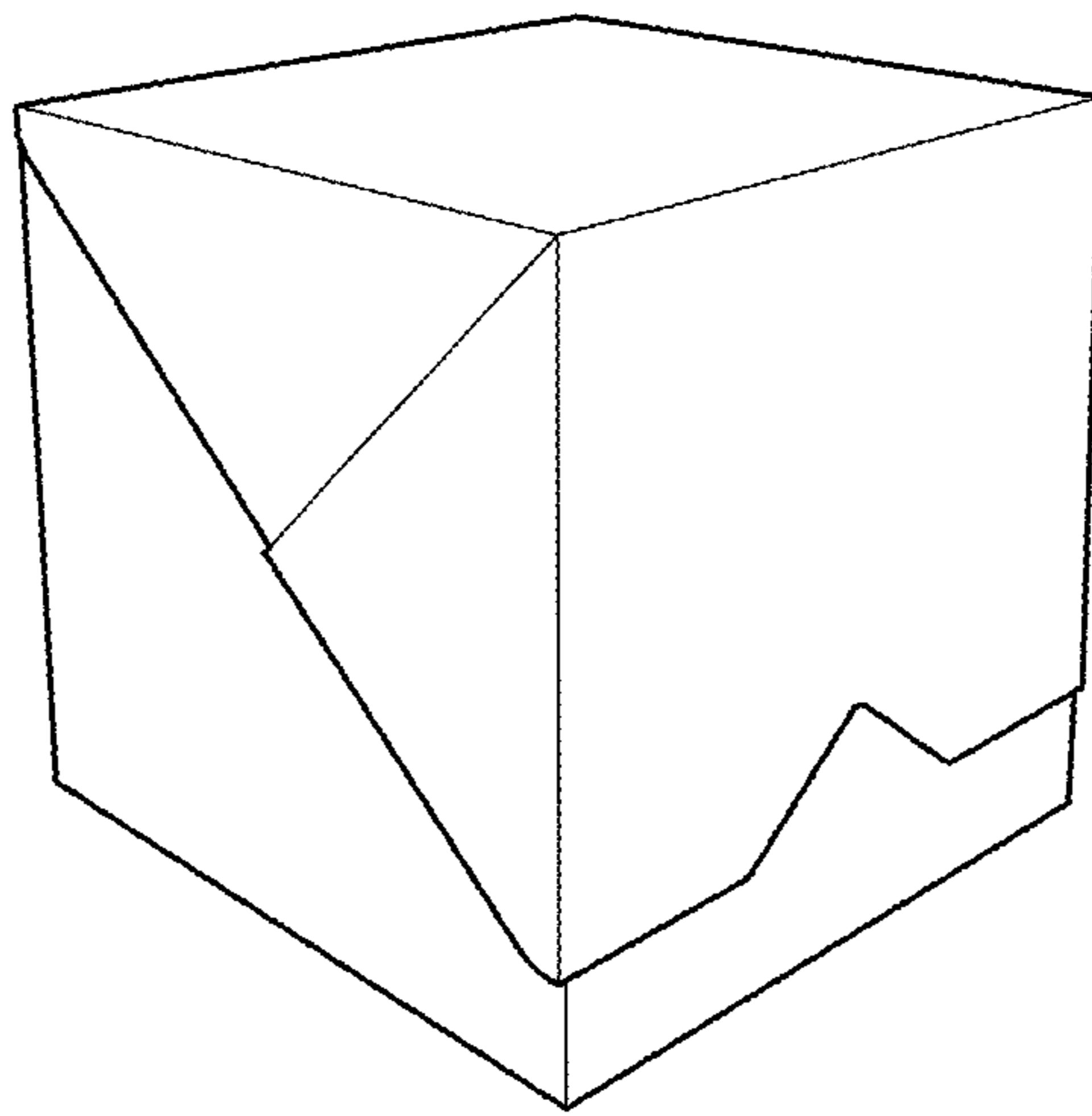

Fig. 8

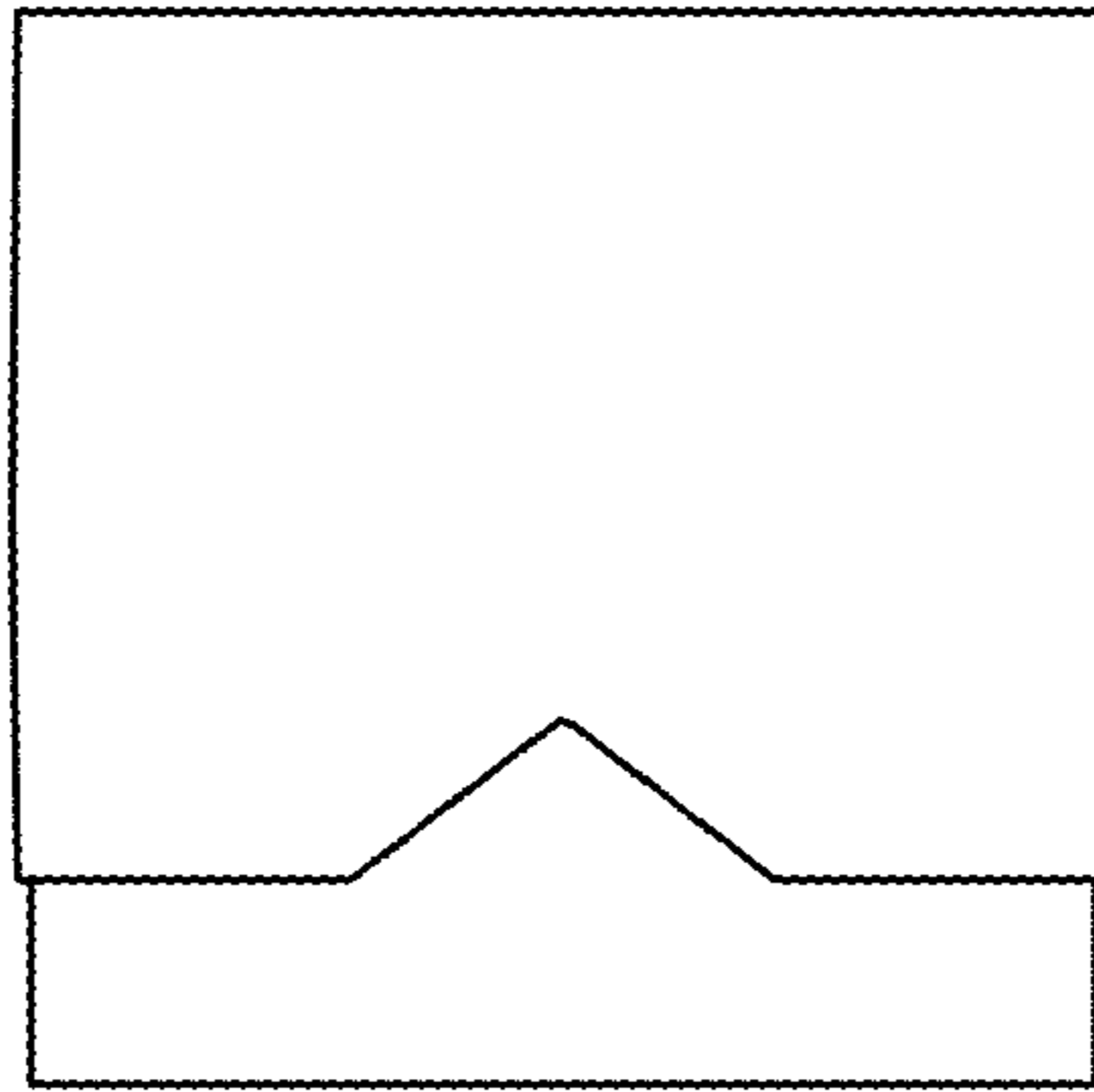

Fig. 9

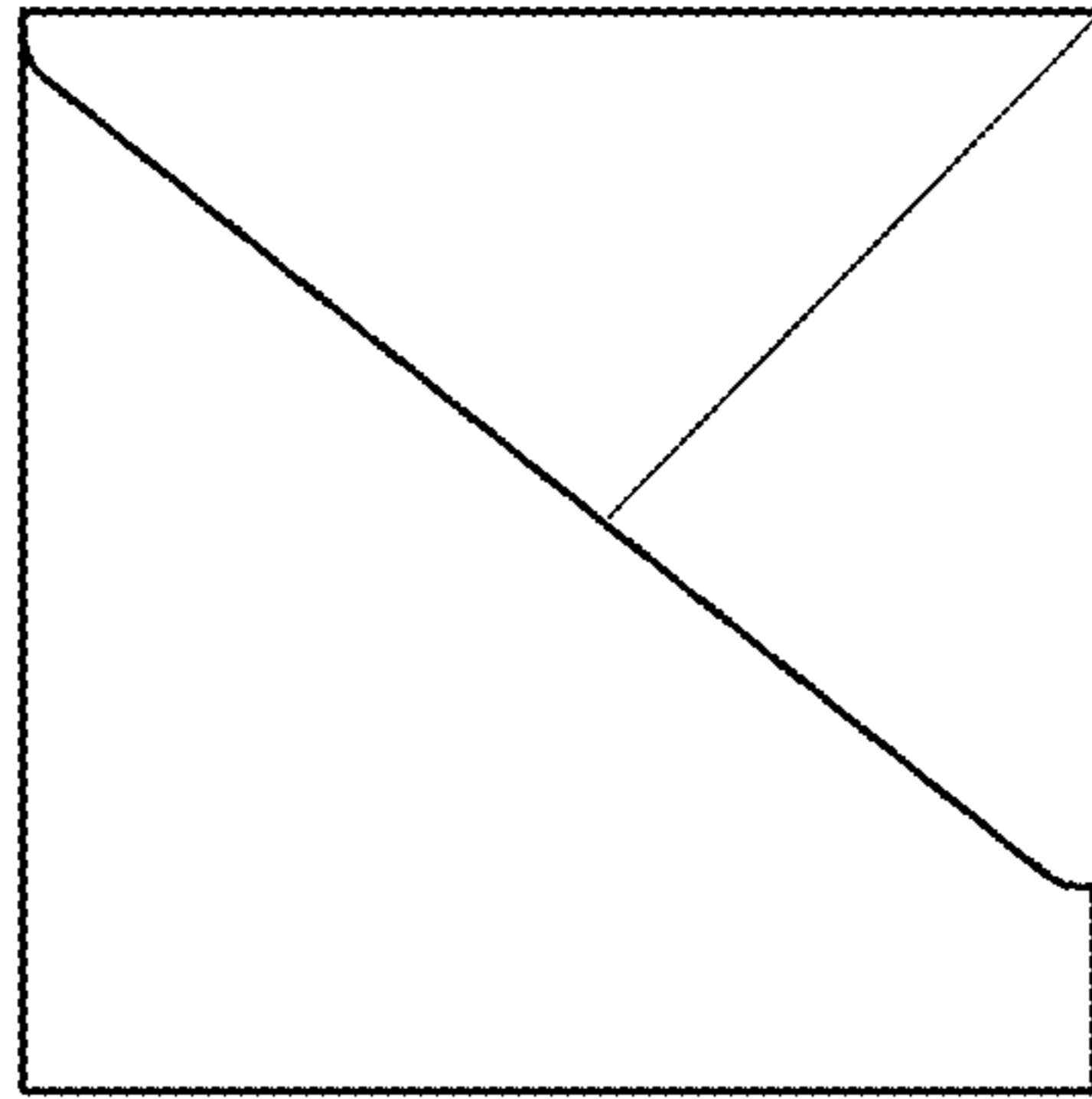

Fig. 10

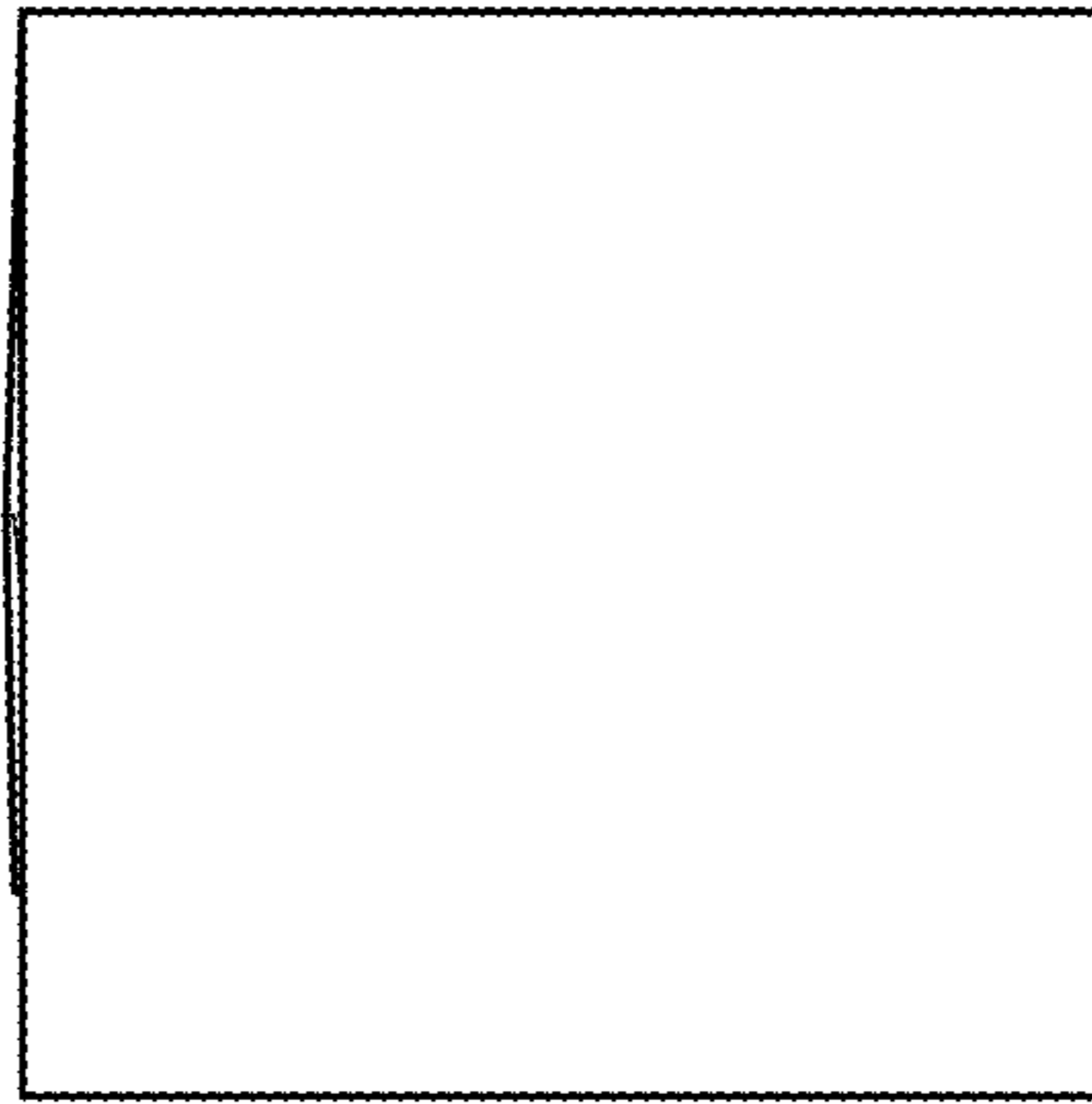

Fig. 11

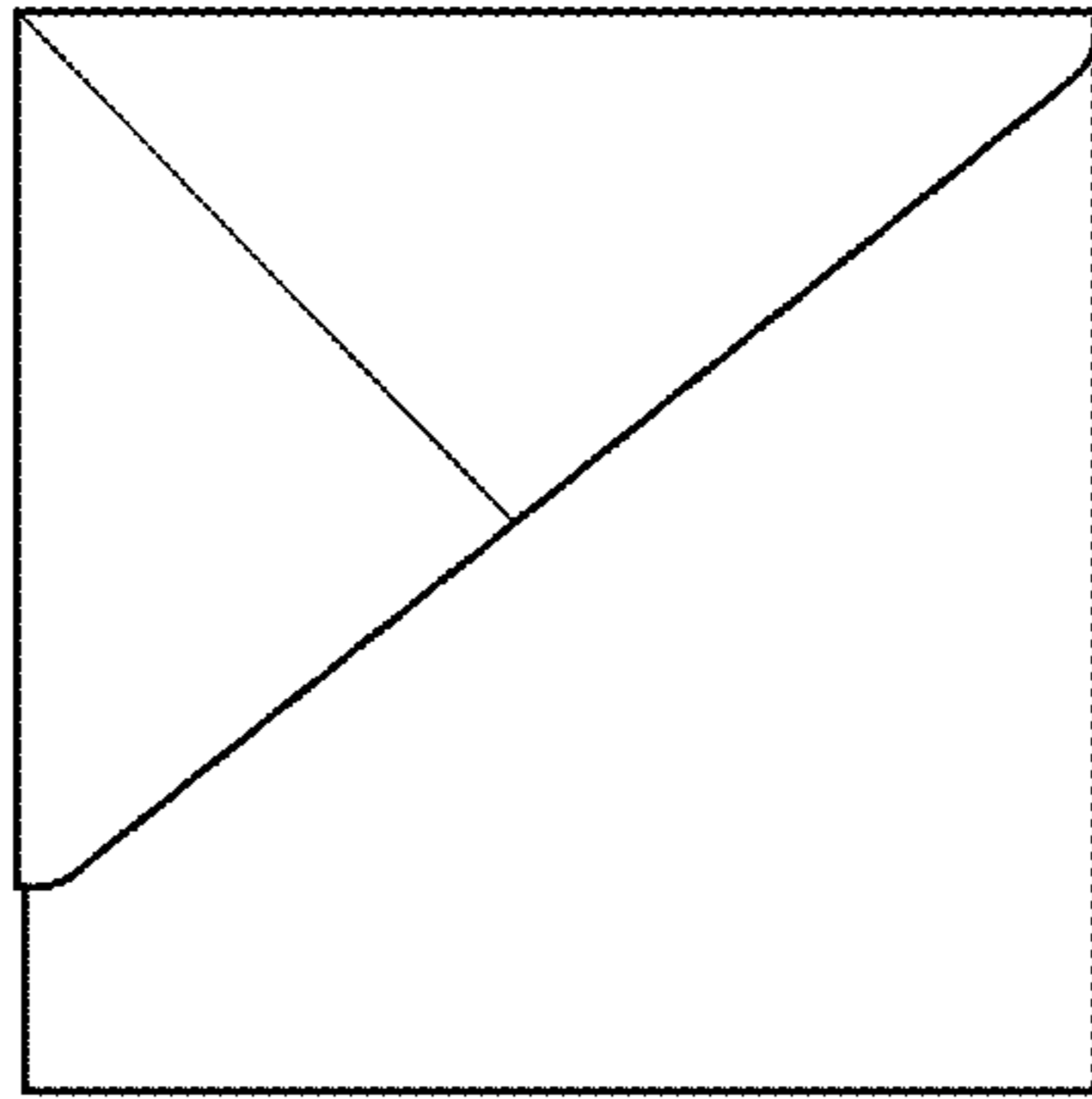

Fig. 12

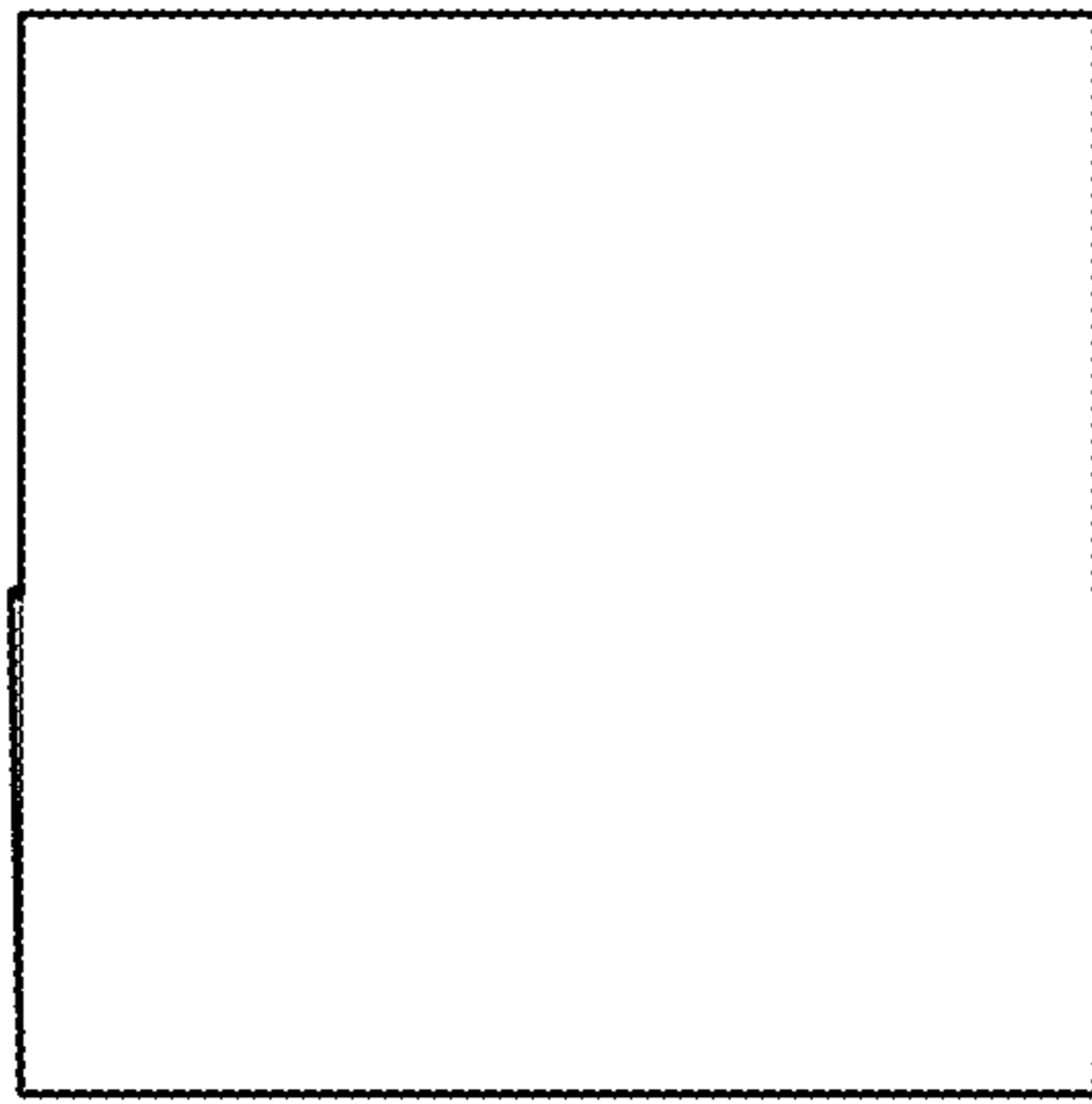

Fig. 13

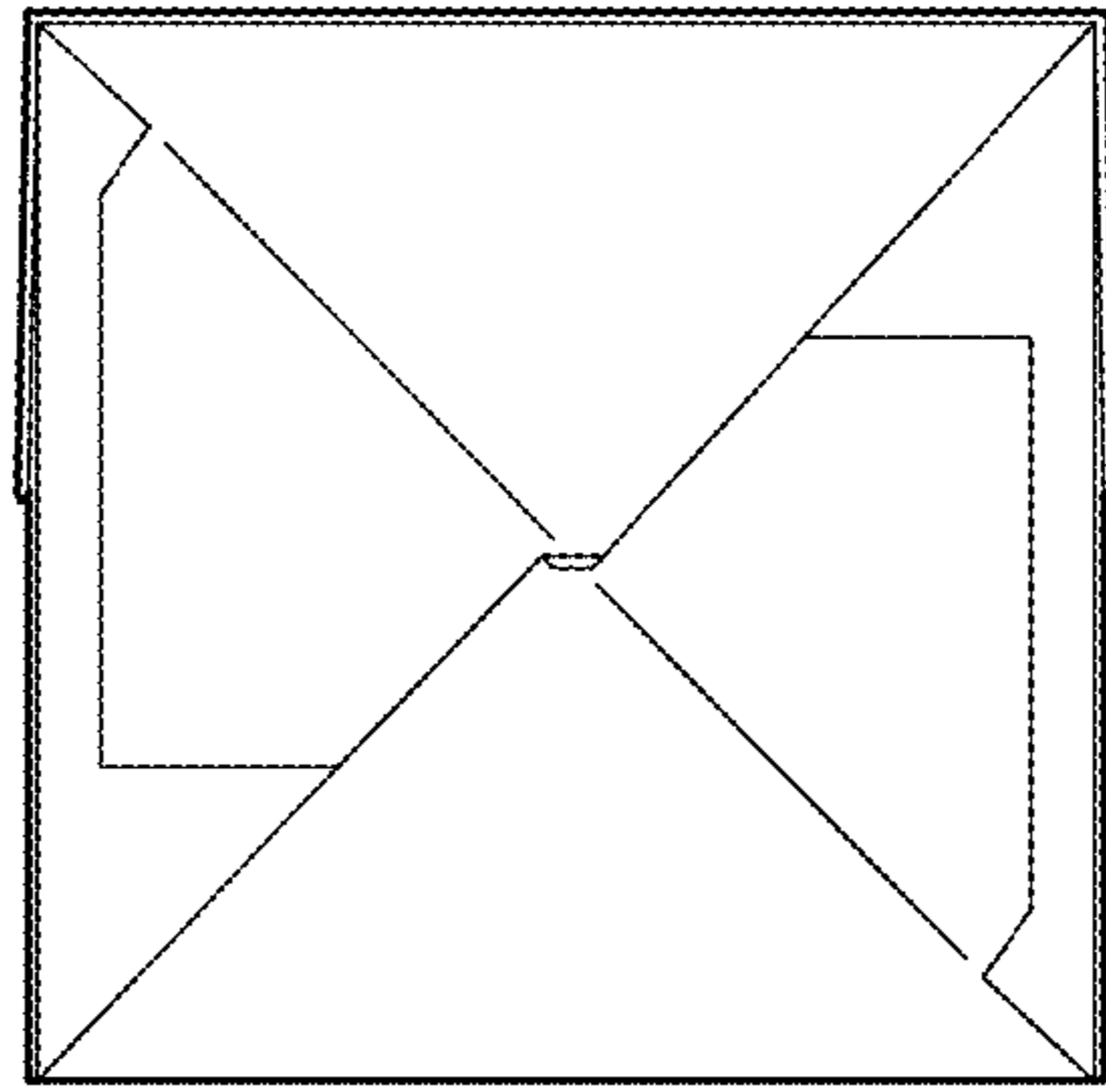

Fig. 14