



US00D885837S

(12) **United States Design Patent** (10) **Patent No.:** **US D885,837 S**
Bo (45) **Date of Patent:** **** Jun. 2, 2020**

(54) **BOTTLE WITH BLUETOOTH SPEAKER**
(71) Applicant: **Anhui Inno-Sign International Co., Ltd.**, Hefei (CN)
(72) Inventor: **Jin Bo**, Hefei (CN)
(73) Assignee: **Anhui Inno-sign International Co., Ltd.**, Hefei (CN)
(**) Term: **15 Years**
(21) Appl. No.: **29/635,266**
(22) Filed: **Jan. 30, 2018**
(51) **LOC (12) Cl.** **07-01**
(52) **U.S. Cl.**
USPC **D7/510; D7/511; D7/532; D14/216**
(58) **Field of Classification Search**
USPC D7/505, 507, 509, 510, 511, 523, 532, D7/608, 300.1, 213, 392.1, 396.2, 387, D7/396.6, 624.1, 624.2, 529, 396.4, 533, D7/536; D9/500, 501, 502, 503, 504, D9/505, 516, 530, 556, 569, 537, 549, D9/557, 546, 517; 220/529.16, 529.17; D24/197; 215/381; D23/207, 209; D14/212, 214, 216
CPC A47G 19/2205; A47G 19/2272; A47G 19/2266; A47J 43/27; A47J 41/02; A45F 3/16

See application file for complete search history.

(56) **References Cited**
U.S. PATENT DOCUMENTS
D401,111 S * 11/1998 Leatherman D7/397
D566,559 S * 4/2008 Swint D9/504
D637,910 S * 5/2011 Yeung D9/504
D638,710 S * 5/2011 Yeung D9/504
D808,927 S * 1/2018 Schaal D14/216
D821,359 S * 6/2018 Tong D14/216
D830,783 S * 10/2018 Diener D7/608
2005/0211712 A1 * 9/2005 Moran A47J 41/0011 220/592.17

* cited by examiner

Primary Examiner — Jae Liang
(74) *Attorney, Agent, or Firm* — Richard Patent Law P.C.

(57) **CLAIM**
The ornamental design for a bottle with bluetooth speaker, as shown and described.

DESCRIPTION
FIG. 1 is an isometric view of a bottle with bluetooth speaker showing my new design;
FIG. 2 is a front view thereof;
FIG. 3 is a back view thereof;
FIG. 4 is a right side view thereof;
FIG. 5 is a left side view thereof;
FIG. 6 is a top view thereof; and,
FIG. 7 is a bottom view thereof.
The broken lines show portions of the article not claimed and form no part of the claimed design.

1 Claim, 7 Drawing Sheets

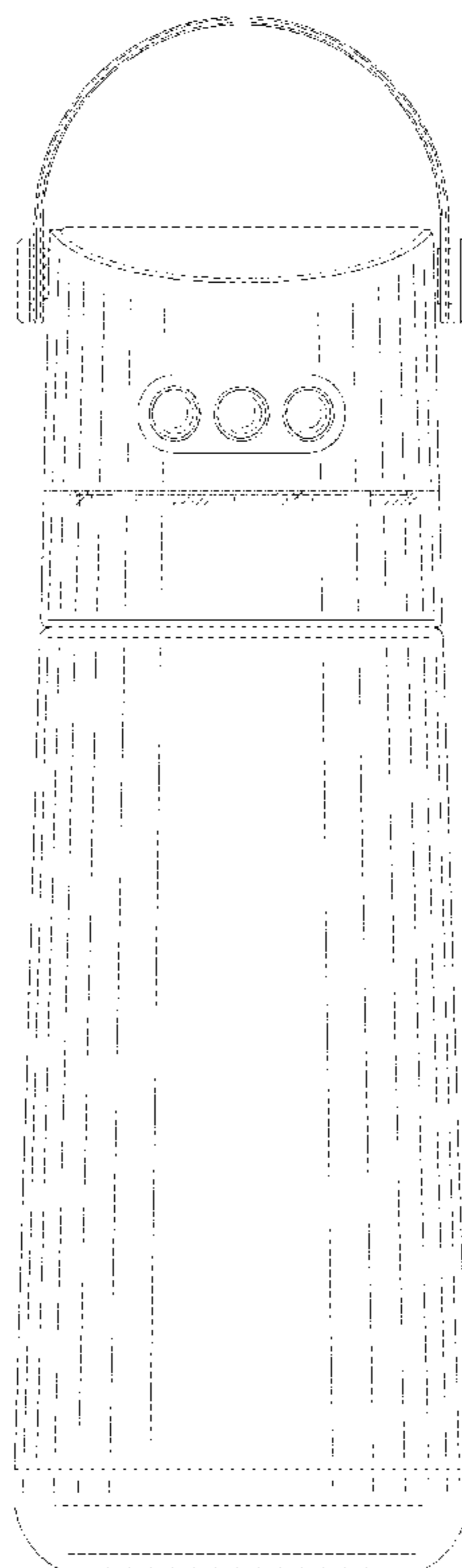

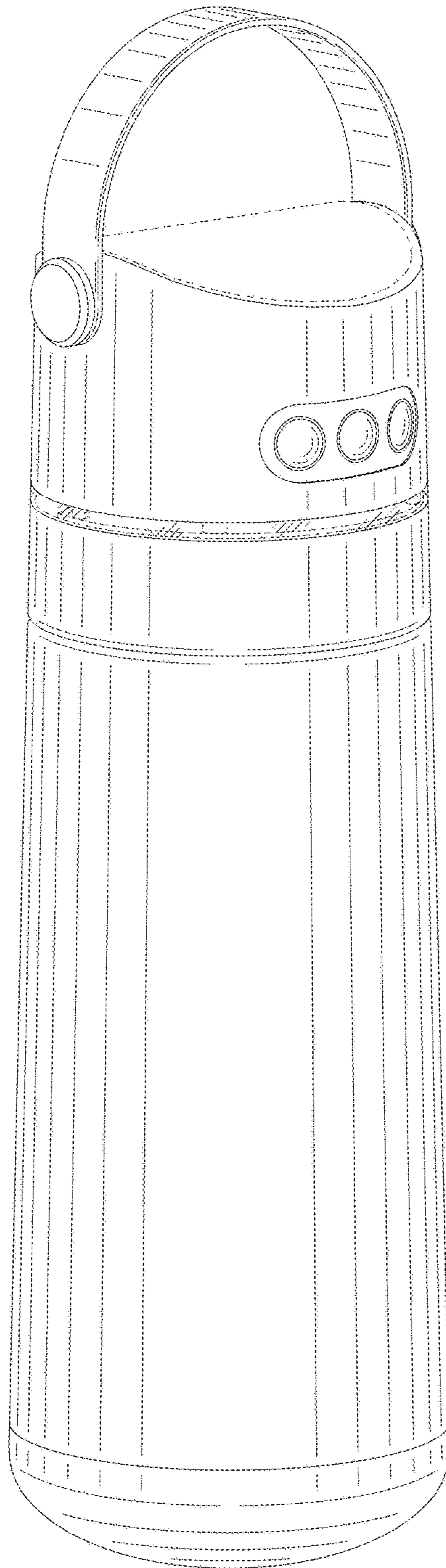

FIG. 1

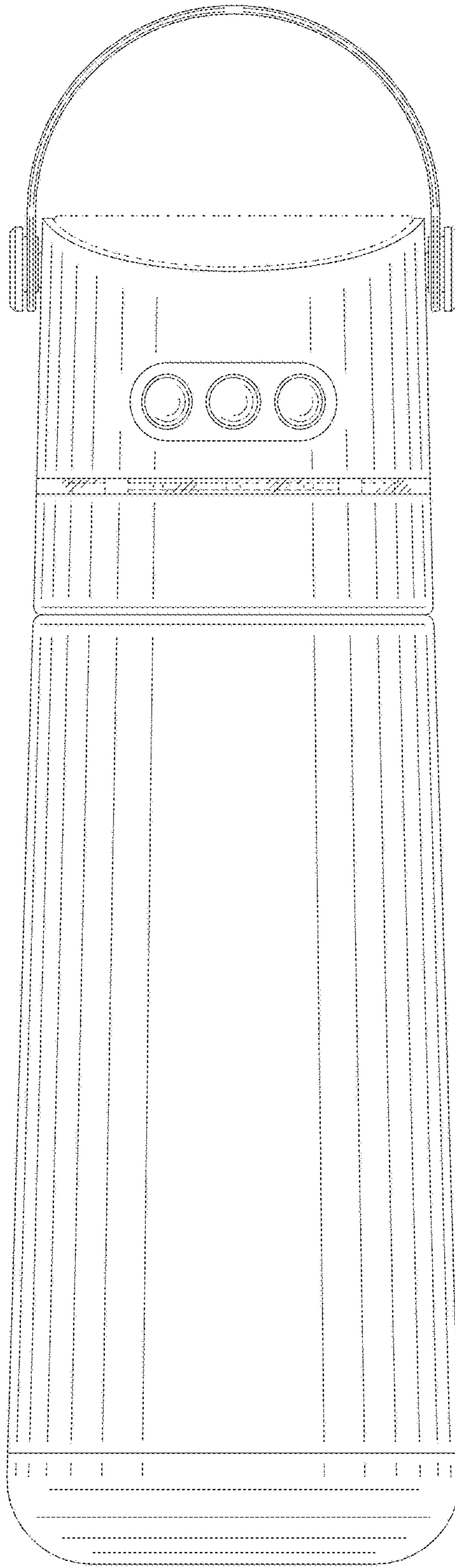

FIG. 2

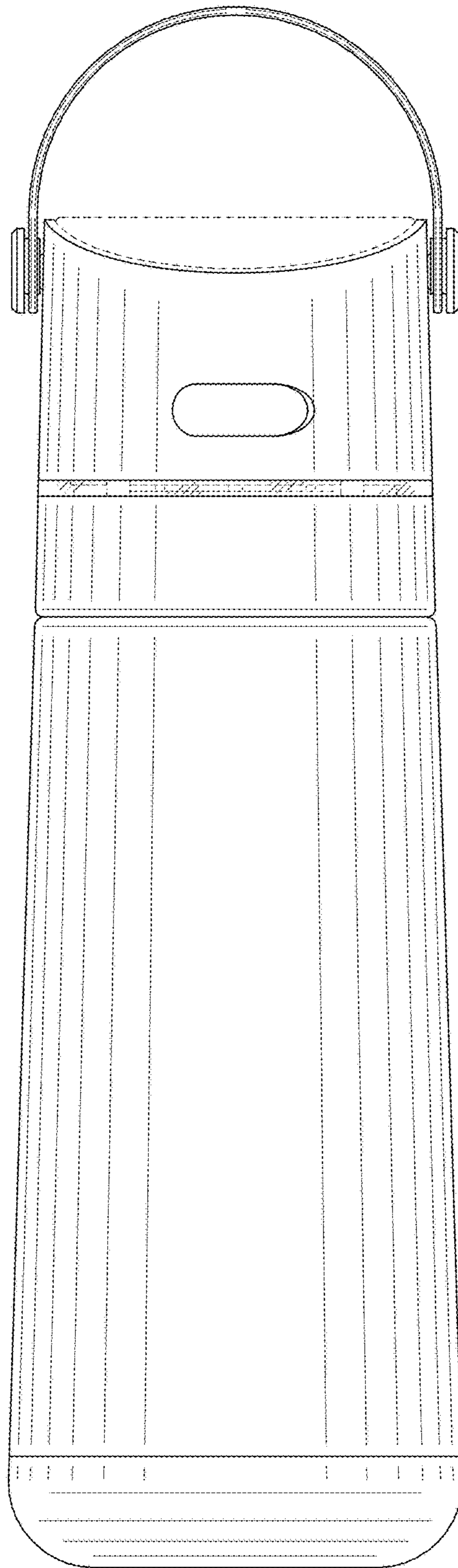

FIG. 3

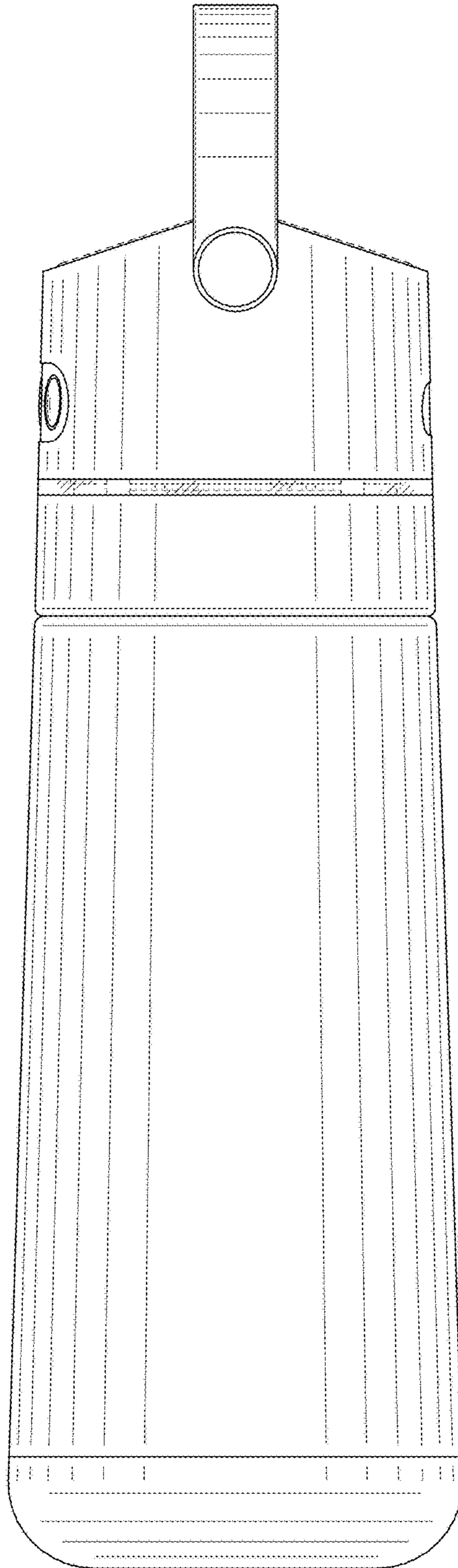

FIG. 4

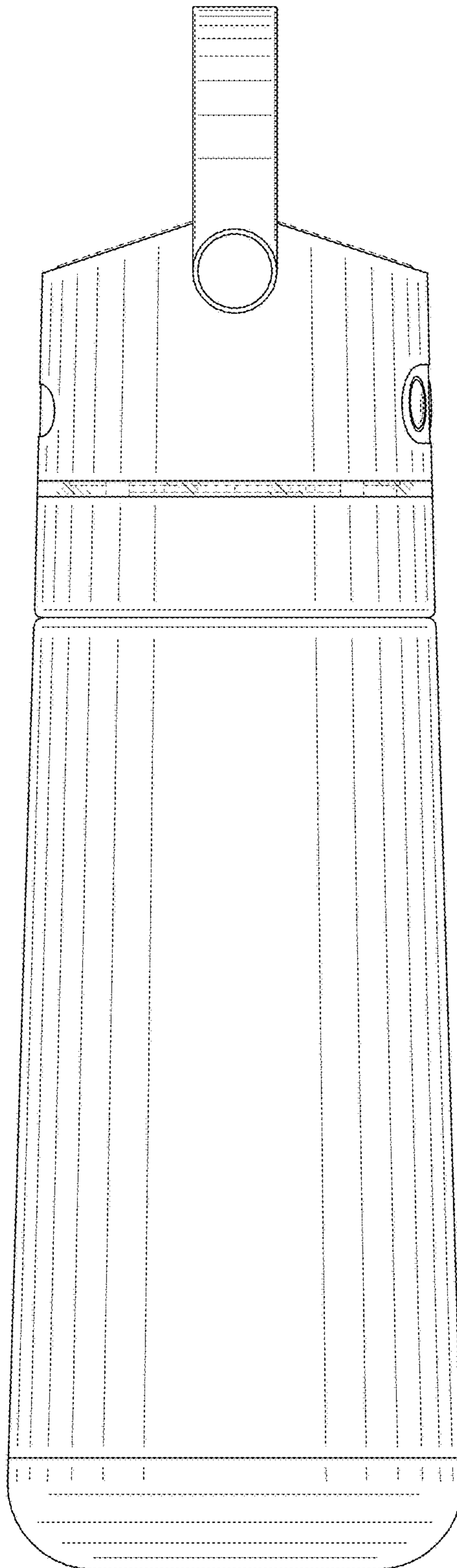

FIG. 5

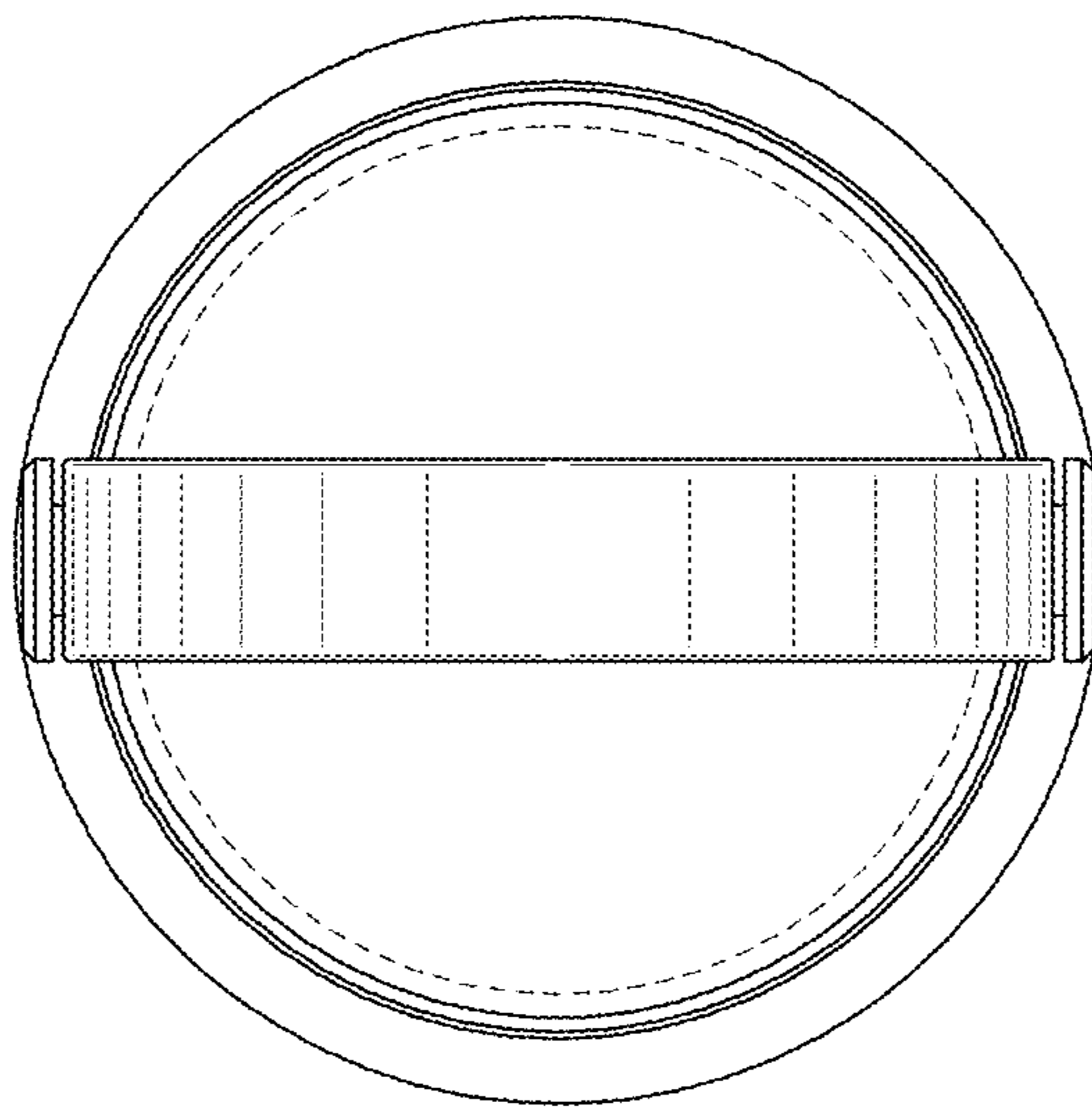

FIG. 6

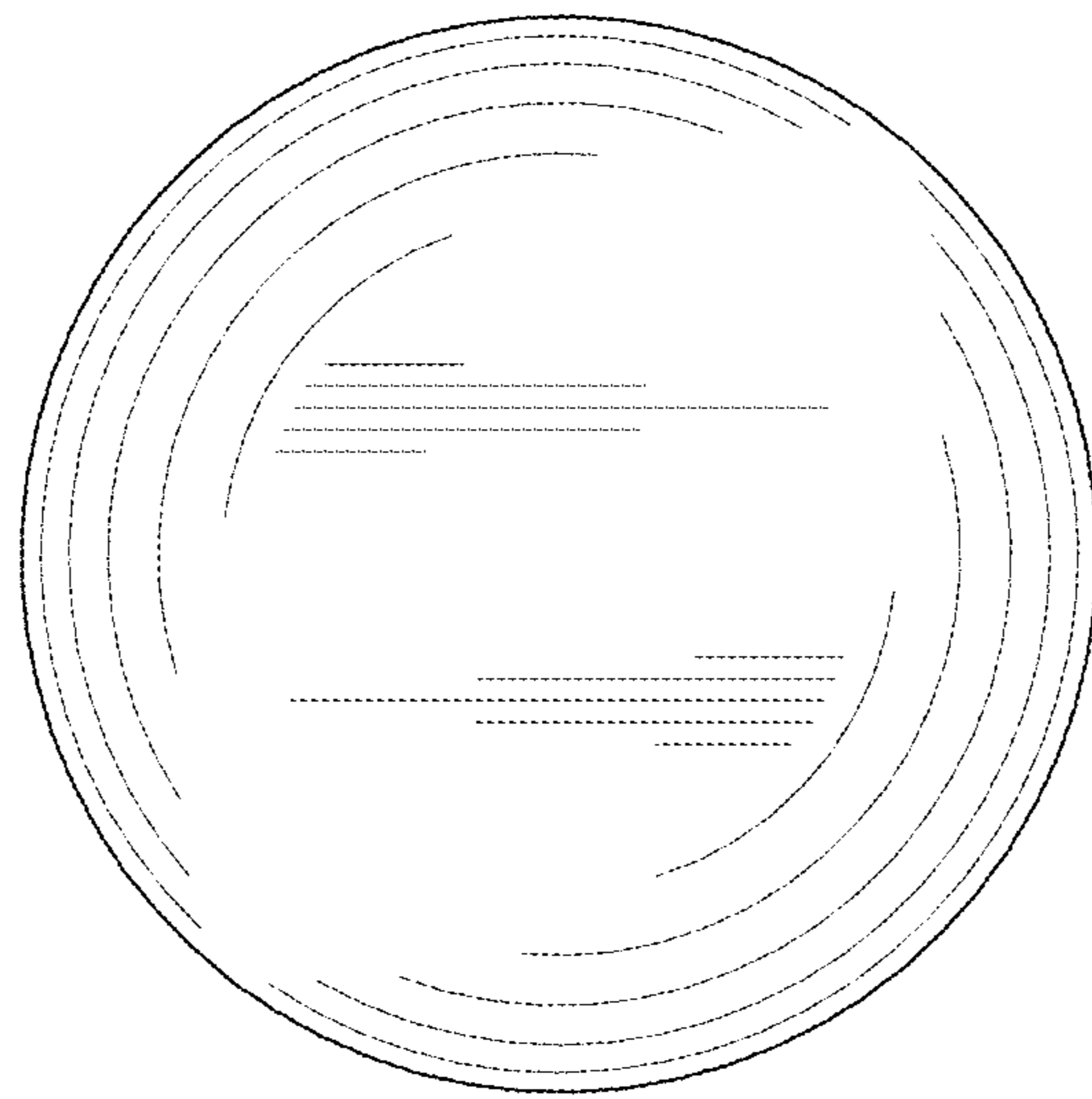

FIG. 7