



US00D885796S

(12) **United States Design Patent** (10) **Patent No.:** **US D885,796 S**
Aruga et al. (45) **Date of Patent:** **** Jun. 2, 2020**

- (54) **CABINET FOR MACHINE TOOL**
- (71) Applicant: **Mitsubishi Heavy Industries Machine Tool Co., Ltd.**, Ritto-shi, Shiga (JP)
- (72) Inventors: **Hiroyasu Aruga**, Tokyo (JP); **Naoki Kazaoka**, Tokyo (JP)
- (73) Assignee: **MITSUBISHI HEAVY INDUSTRIES MACHINE TOOL CO., LTD.**, Shiga (JP)
- (**) Term: **15 Years**
- (21) Appl. No.: **29/690,568**
- (22) Filed: **May 9, 2019**

- (56) **References Cited**
- U.S. PATENT DOCUMENTS

D97,689 S	*	12/1935	Vickerman	D15/85
D143,753 S	*	2/1946	Pinelli	D15/81
D216,226 S	*	12/1969	Barrero	D15/88
D278,342 S		4/1985	Damkjaer	
D293,985 S	*	2/1988	White	D6/676
D330,469 S	*	10/1992	Brodbeck	D6/643
D349,829 S		8/1994	Bustos	
D365,472 S		12/1995	Rehnberg	
D370,226 S	*	5/1996	Hebert	D15/85
D378,882 S		4/1997	Inman	
D388,228 S		12/1997	Dallman	
D400,684 S		11/1998	Dallman	
D427,211 S	*	6/2000	Piterski	D15/85
D466,333 S		12/2002	Hwang	
D468,114 S		1/2003	Ong	
D542,812 S	*	5/2007	Mori	D15/86

(Continued)

Related U.S. Application Data

- (62) Division of application No. 29/601,135, filed on Apr. 19, 2017, now Pat. No. Des. 869,207.

Foreign Application Priority Data

- Oct. 20, 2016 (JP) 2016-022798
- Oct. 20, 2016 (JP) 2016-022799
- (51) **LOC (12) Cl.** **06-06**
- (52) **U.S. Cl.**
USPC **D6/663**
- (58) **Field of Classification Search**
USPC D6/657, 660, 661, 661.1, 663, 668,
D6/668.1, 672, 676, 682; D15/122, 89,
D15/199
CPC A47F 3/043; A47F 3/0404; A47F 3/0434;
A47B 47/02; A47B 88/00; A47B 81/00;
A47B 81/002
See application file for complete search history.

Primary Examiner — Kelley A Donnelly
(74) *Attorney, Agent, or Firm* — Birch, Stewart, Kolasch & Birch, LLP.

(57) **CLAIM**
The ornamental design for a cabinet for machine tool, as shown and described.

DESCRIPTION

FIG. 1 is a front right perspective view of a first embodiment of our new design for a cabinet for machine tool;
FIG. 2 is a front left perspective view thereof;
FIG. 3 is a front elevation view thereof;
FIG. 4 is a left side elevation view thereof;
FIG. 5 is a top plan view thereof;
FIG. 6 is a bottom plan view thereof;
FIG. 7 is a right side elevation view thereof;
FIG. 8 is a rear view thereof; and,
FIG. 9 is a referential view thereof which shows the door open.
Portions illustrated in dashed lines are for illustrating environment and do not form part of the claimed design.

1 Claim, 9 Drawing Sheets

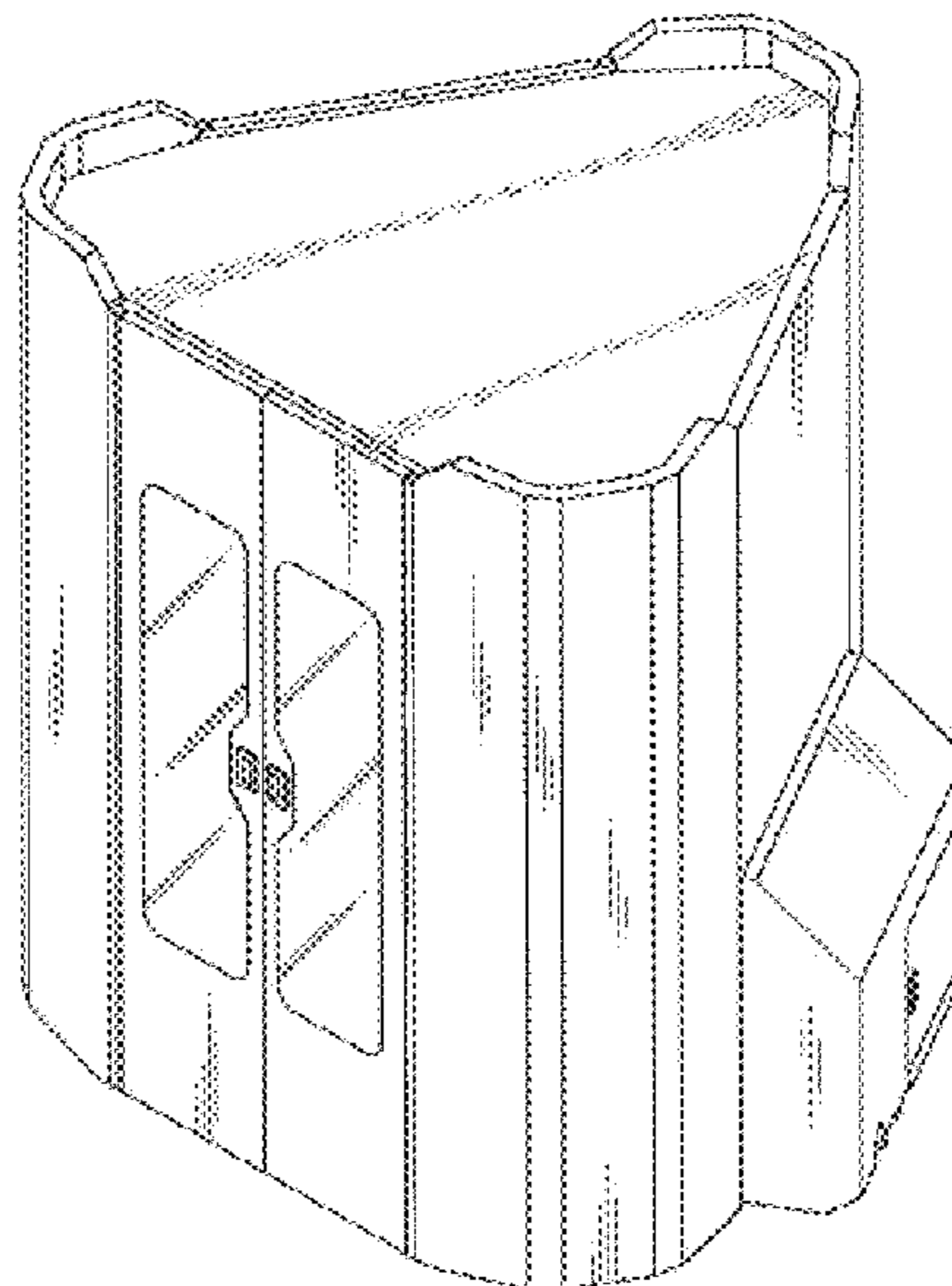

(56)

References Cited

U.S. PATENT DOCUMENTS

D548,490 S	8/2007	Becker et al.	
D596,209 S *	7/2009	Mitchell	D15/85
D604,342 S	11/2009	Lodridge	
D668,080 S	10/2012	Doron	
D674,914 S	1/2013	Hernandez et al.	
D698,373 S *	1/2014	John	D15/85
D711,166 S	8/2014	Anderson et al.	
D797,475 S	9/2017	Awad	
D811,770 S	3/2018	Brownley et al.	
D824,194 S	7/2018	Kagan	
D827,323 S	9/2018	Stoffel	
D828,056 S	9/2018	Chiao et al.	
D829,471 S	10/2018	Fortmann et al.	

* cited by examiner

FIG. 1

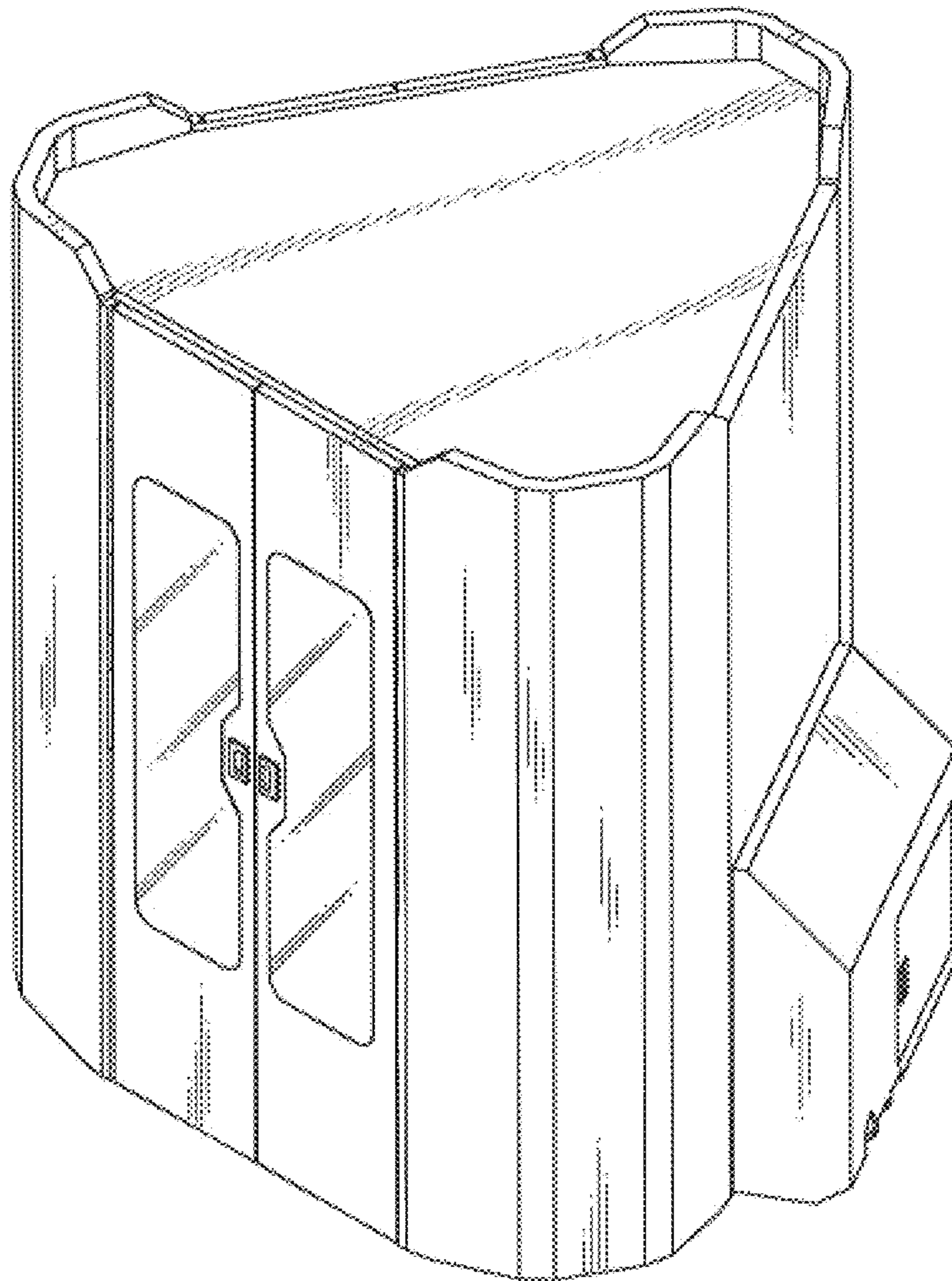

FIG. 2

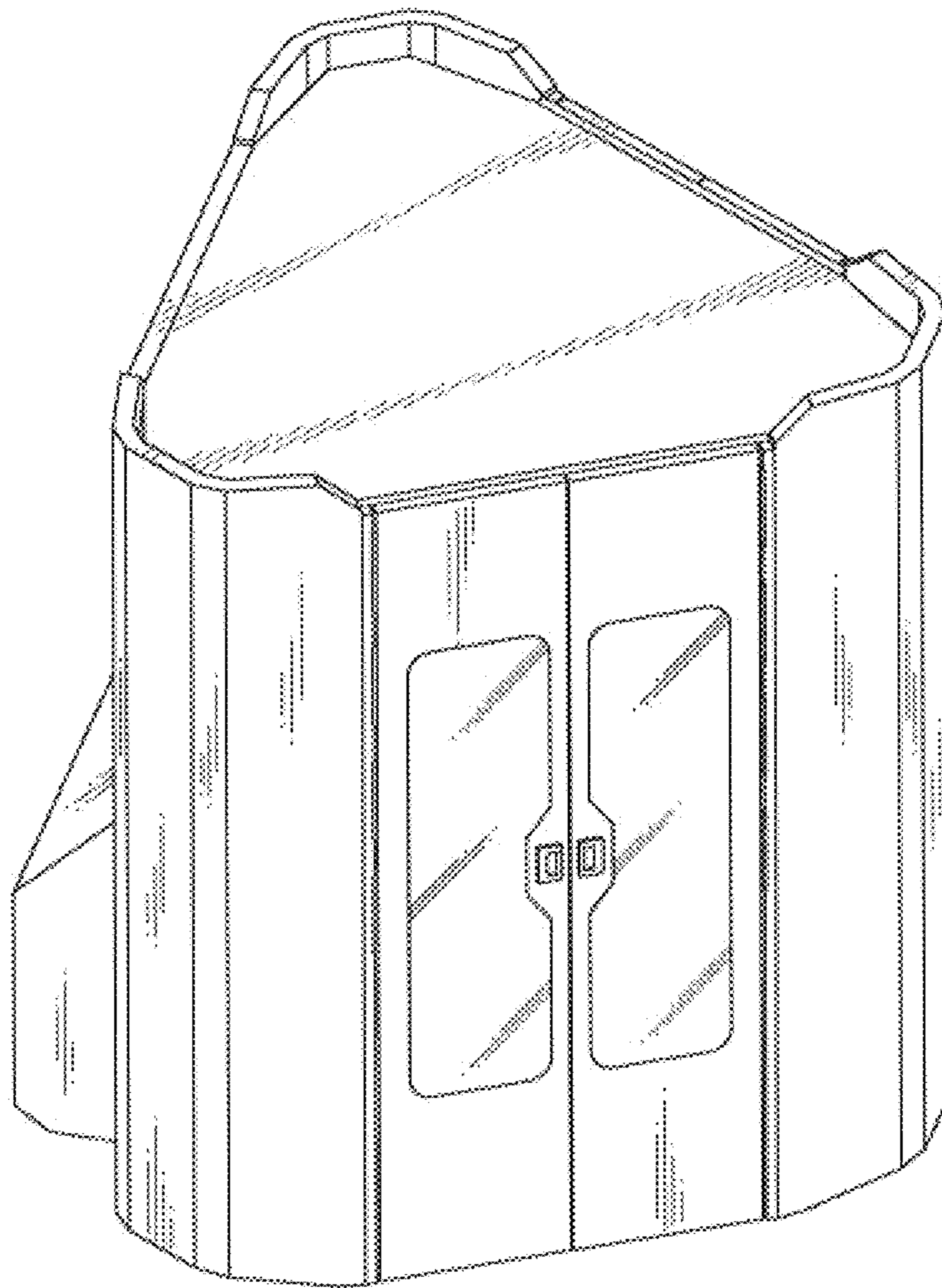

FIG. 3

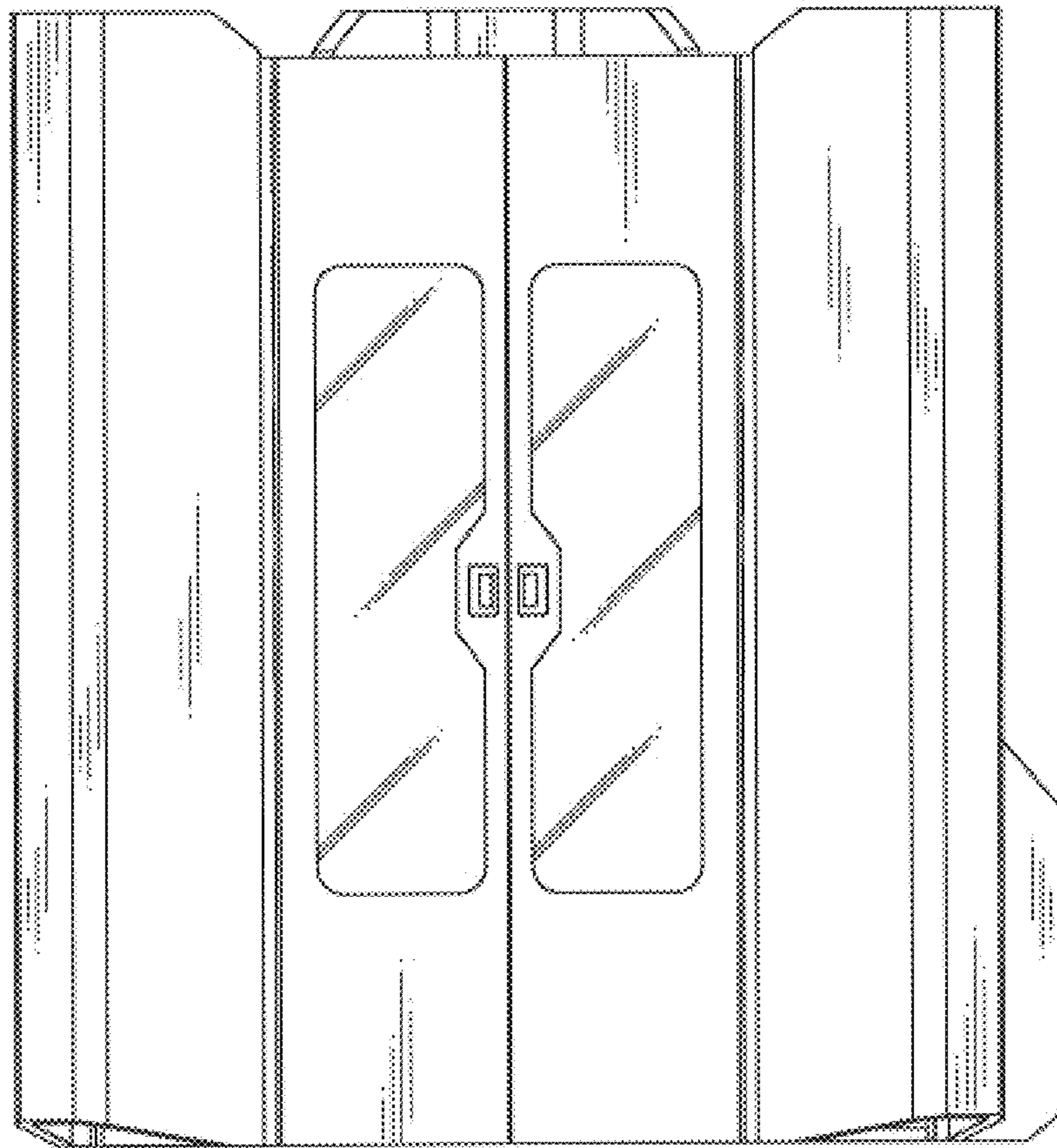

FIG. 4

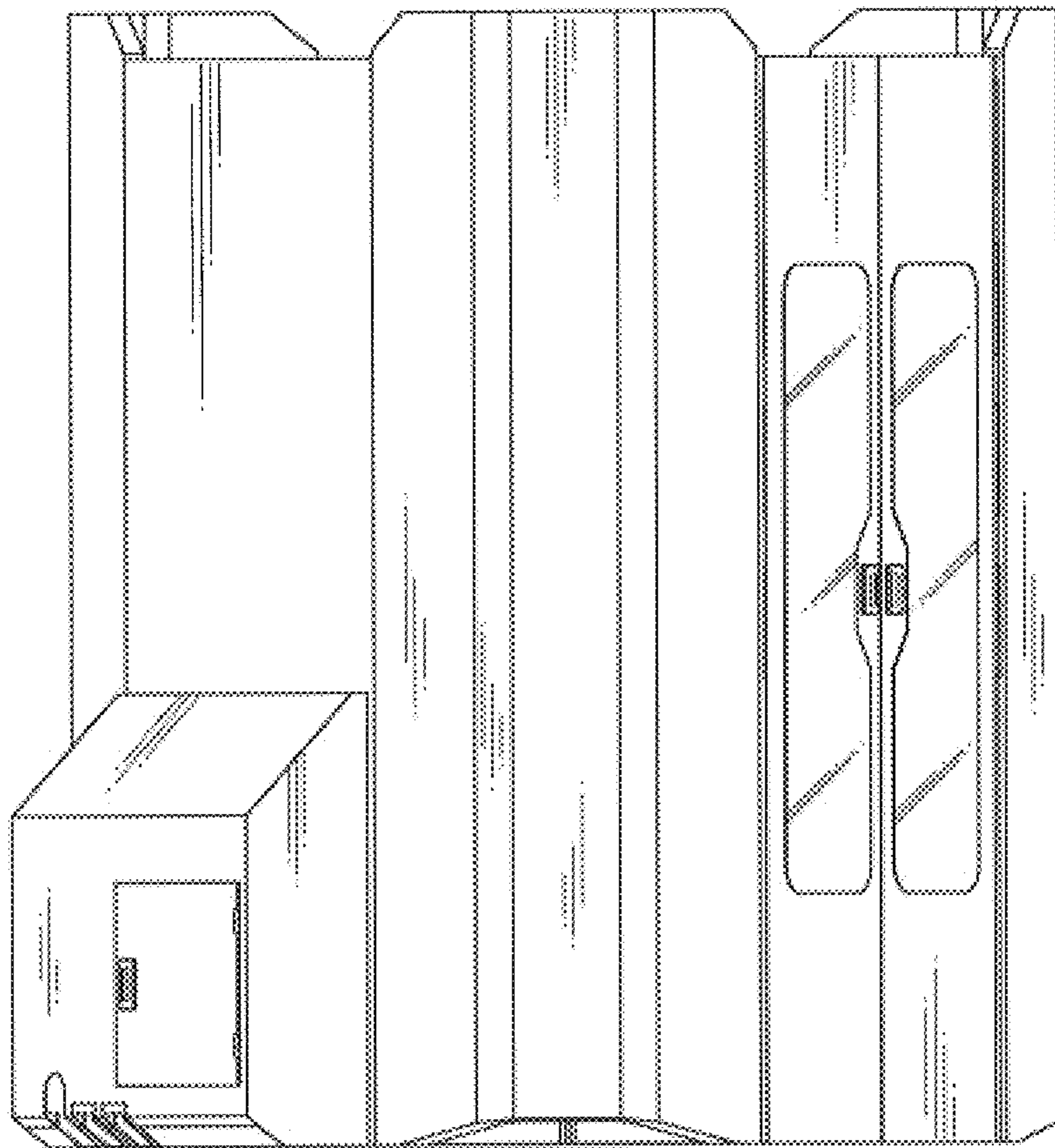

FIG. 5

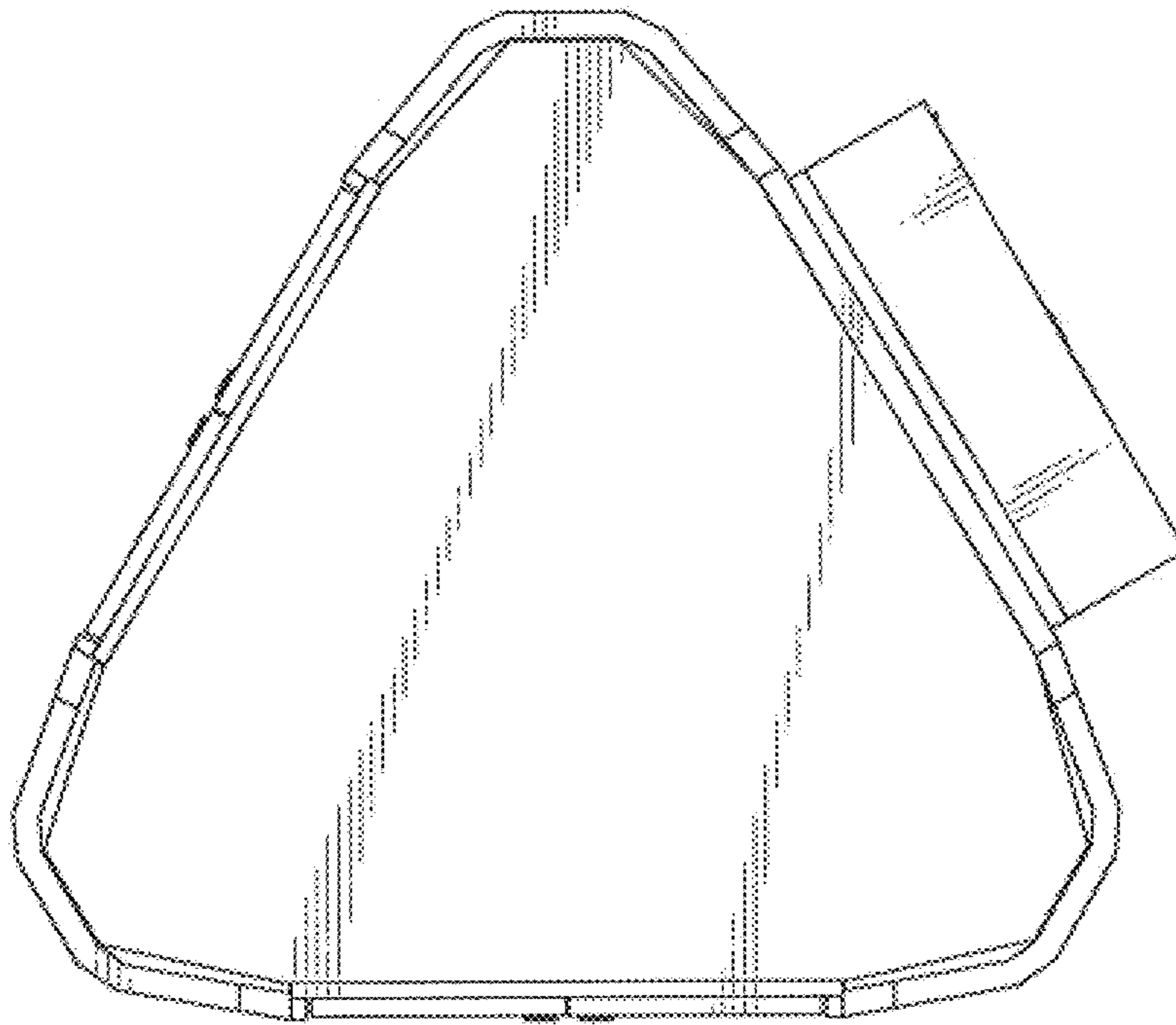

FIG. 6

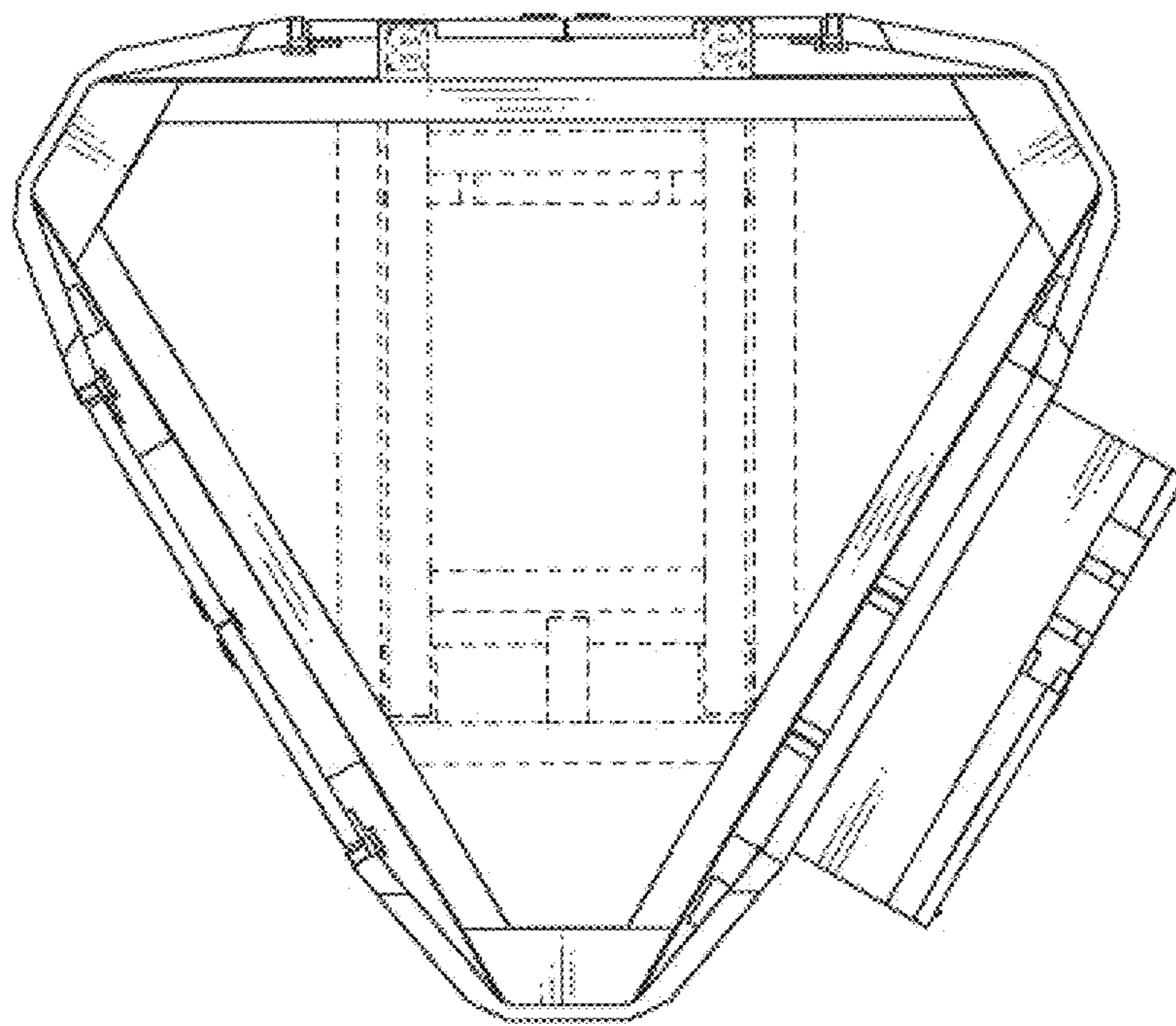

FIG. 7

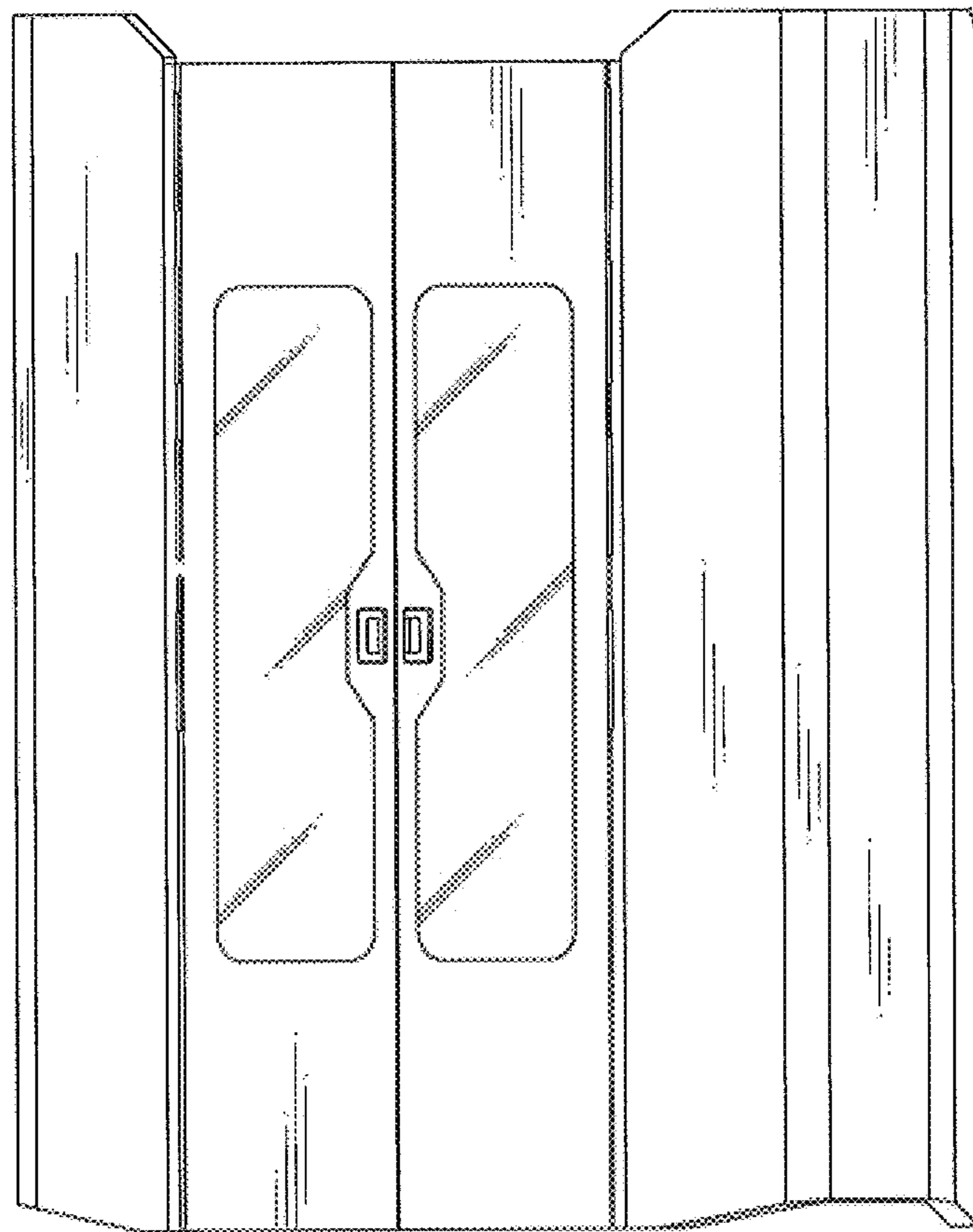

FIG. 8

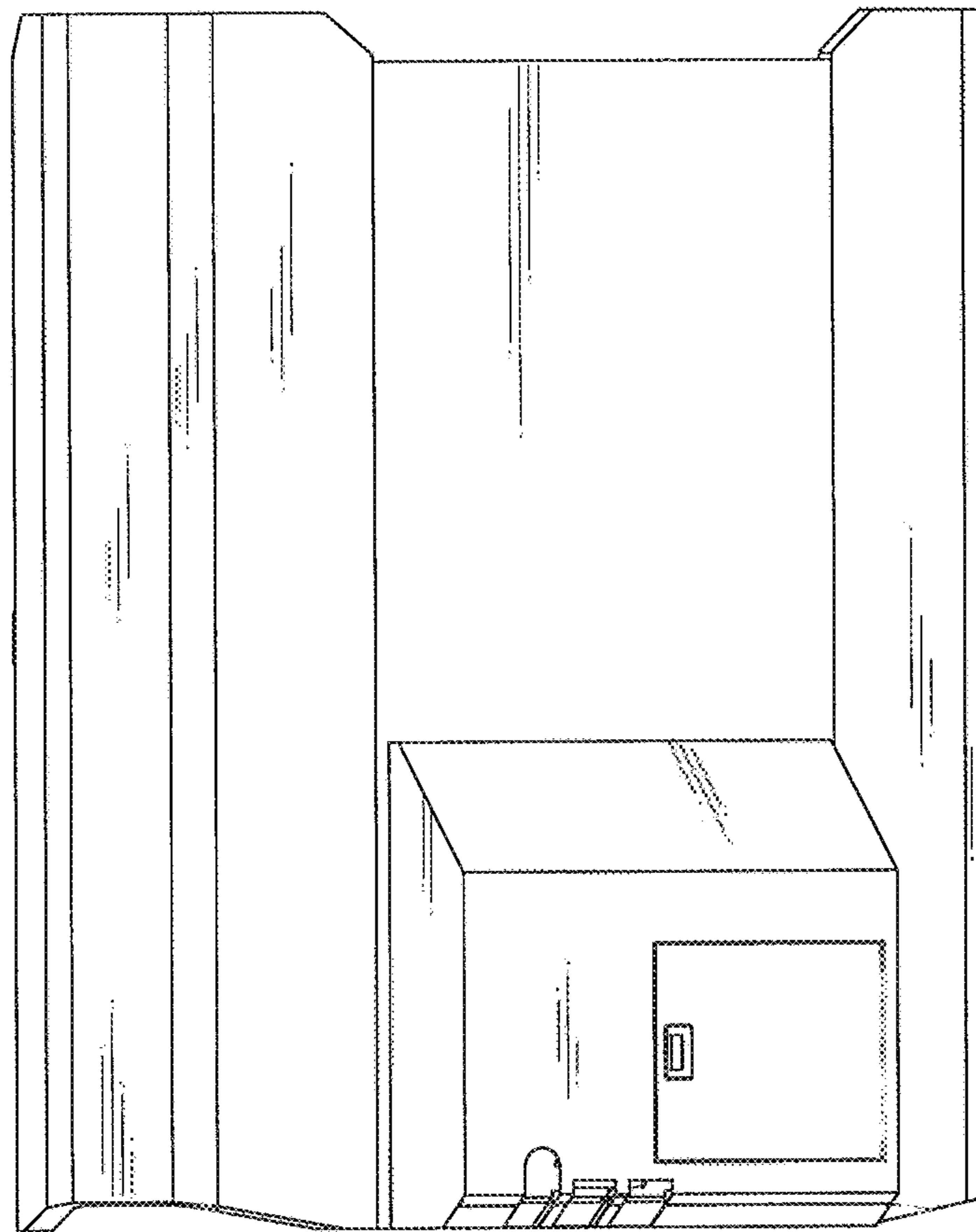

FIG. 9

